

Operating Instructions

Cerabar M

Deltabar M

Deltapilot M

Process pressure / Differential pressure, Flow /
Hydrostatic



Cerabar M

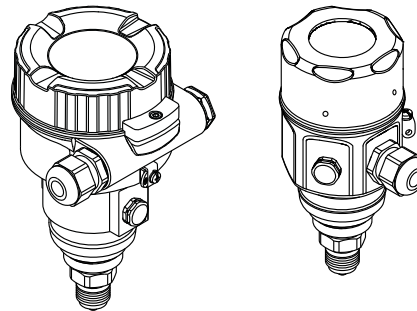

Deltabar M

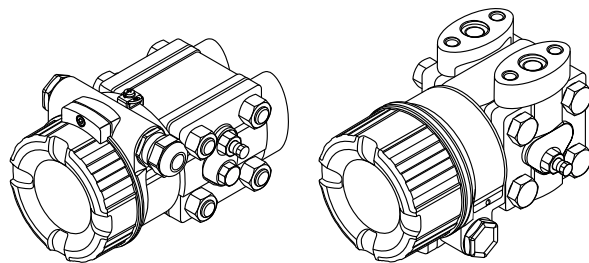

Deltapilot M

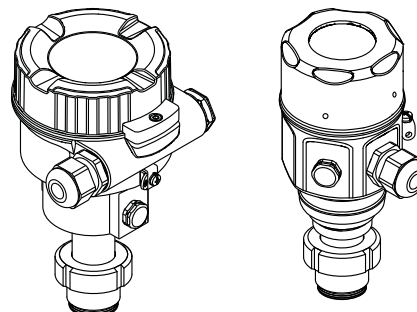

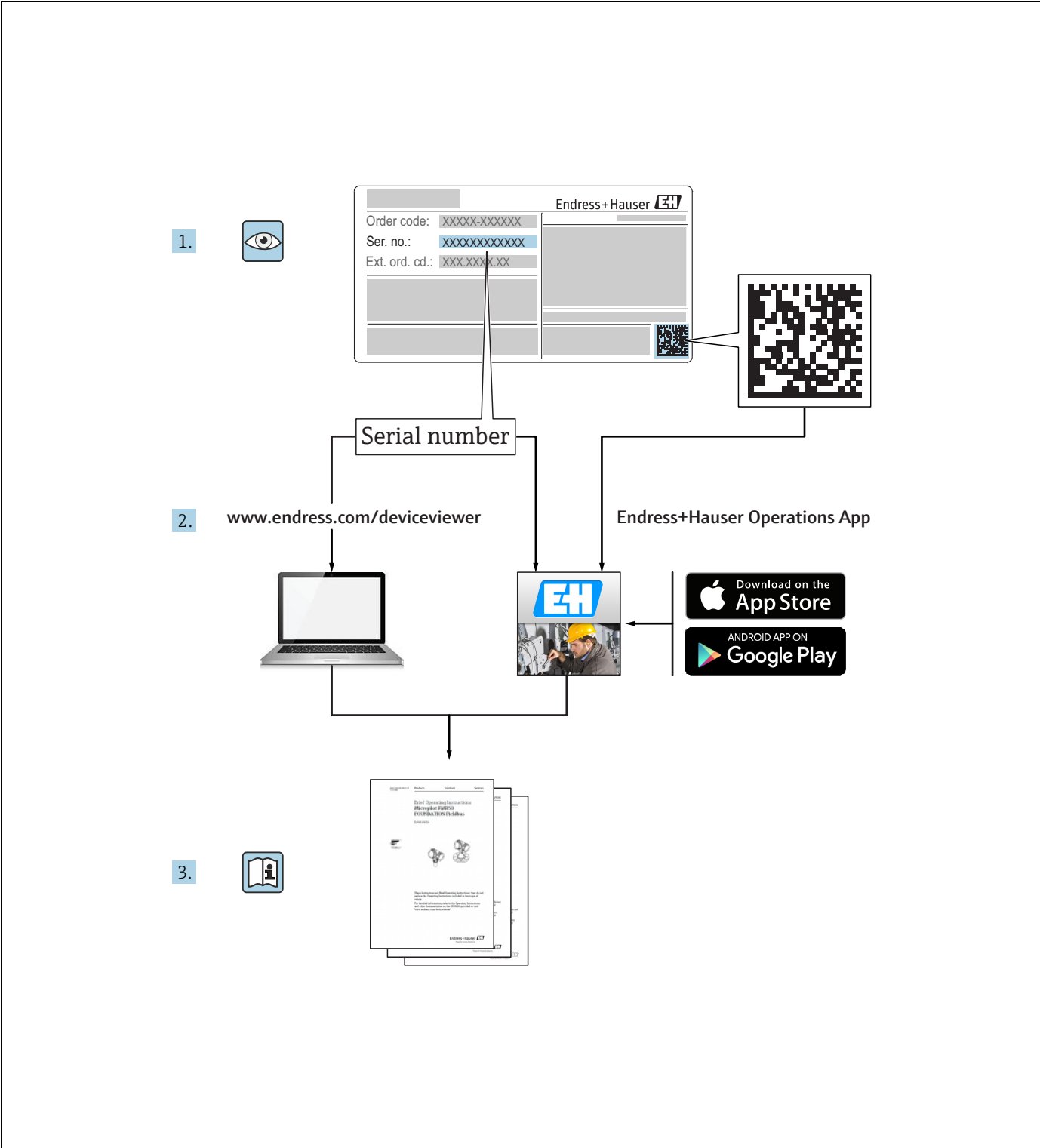

A0023555

Make sure the document is stored in a safe place such that it is always available when working on or with the device.
To avoid danger to individuals or the facility, read the "Basic safety instructions" section carefully, as well as all other safety instructions in the document that are specific to working procedures.
The manufacturer reserves the right to modify technical data without prior notice. Your Endress+Hauser distributor will supply you with current information and updates to these Instructions.

Table of contents

1	Document information	4	8	Commissioning with an operating menu (onsite display/FieldCare)	71
1.1	Document function	4	8.1	Function check	71
1.2	Symbols used	4	8.2	Commissioning	71
2	Basic safety instructions	6	8.3	Pos. zero adjust	73
2.1	Requirements concerning the staff	6	8.4	Level measurement (Cerabar M and Deltapilot M)	74
2.2	Designated use	6	8.5	Linearization	84
2.3	Workplace safety	6	8.6	Pressure measurement	90
2.4	Operational safety	6	8.7	Differential pressure measurement (Deltabar M)	91
2.5	Hazardous area	7	8.8	Flow measurement (Deltabar M)	93
2.6	Product safety	7	8.9	Level measurement (Deltabar M)	96
3	Identification	8	8.10	Overview of the onsite display operating menu	108
3.1	Product identification	8	8.11	Description of parameters	116
3.2	Device designation	8	9	Commissioning with the FF configuration program	138
3.3	Scope of delivery	11	9.1	Function check	138
3.4	CE mark, Declaration of Conformity	11	9.2	Commissioning with FF application	138
4	Installation	12	9.3	Scaling the OUT parameter	141
4.1	Incoming acceptance	12	9.4	Commissioning with device application	142
4.2	Storage and transport	12	9.5	Pos. Zero Adjust	144
4.3	Installation conditions	12	9.6	Pressure measurement	145
4.4	General installation instructions	13	9.7	Level measurement	146
4.5	Installing Cerabar M	14	9.8	Flow measurement (Deltabar M)	155
4.6	Installing Deltabar M	24	9.9	Linearization	159
4.7	Installing Deltapilot M	32	9.10	Electrical differential pressure measurement with gauge pressure sensors (Cerabar M or Deltapilot M)	161
4.8	Installing profile seal for universal process adapter	37	9.11	Displaying external values on the onsite display via FF bus	163
4.9	Closing the housing cover	37	9.12	Description of parameters	164
4.10	Post-installation check	37	10	Maintenance	220
5	Electrical connection	38	10.1	Cleaning instructions	220
5.1	Connecting the device	38	10.2	Exterior cleaning	220
5.2	Connecting the measuring unit	39	11	Troubleshooting	221
5.3	Potential equalization	40	11.1	Messages	221
5.4	Overvoltage protection (optional)	41	11.2	Response of outputs to errors	225
5.5	Post-connection check	43	11.3	Repair	226
6	Operation	44	11.4	Repair of Ex-certified devices	226
6.1	Operating options	44	11.5	Spare Parts	226
6.2	Operation without an operating menu	46	11.6	Return	226
6.3	Operation with an operating menu	48	11.7	Disposal	226
6.4	FOUNDATION Fieldbus communication protocol	56	11.8	Software history	227
7	Commissioning without an operating menu	69	12	Technical data	228
7.1	Function check	69	Index	229	
7.2	Position adjustment	69			





1 Document information

1.1 Document function







These Operating Instructions contain all the information that is required in various phases of the life cycle of the device: from product identification, incoming acceptance and storage, to mounting, connection, operation and commissioning through to troubleshooting, maintenance and disposal.

1.2 Symbols used



1.2.1 Safety symbols

Symbol	Meaning
 A0011189-DE	DANGER! This symbol alerts you to a dangerous situation. Failure to avoid this situation will result in serious or fatal injury.
 A0011190-DE	WARNING! This symbol alerts you to a dangerous situation. Failure to avoid this situation can result in serious or fatal injury.
 A0011191-DE	CAUTION! This symbol alerts you to a dangerous situation. Failure to avoid this situation can result in minor or medium injury.
 A0011192-DE	NOTICE! This symbol contains information on procedures and other facts which do not result in personal injury.









1.2.2 Electrical symbols

Symbol	Meaning	Symbol	Meaning
	Direct current		Alternating current
	Direct current and alternating current		Ground connection A grounded terminal which, as far as the operator is concerned, is grounded via a grounding system.
	Protective ground connection A terminal which must be connected to ground prior to establishing any other connections.		Equipotential connection A connection that has to be connected to the plant grounding system: This may be a potential equalization line or a star grounding system depending on national or company codes of practice.

1.2.3 Tool symbols

Symbol	Meaning
 A0011221	Allen key
 A0011222	Hexagon wrench

1.2.4 Symbols for certain types of information

Symbol	Meaning
 A0011182	Permitted Indicates procedures, processes or actions that are permitted.
 A0011184	Forbidden Indicates procedures, processes or actions that are forbidden.
 A0011193	Tip Indicates additional information.
 A0015482	Reference to documentation
 A0015484	Reference to page
 A0015487	Reference to graphic
1. , 2. , ...	Series of steps
 A0018343	Result of a sequence of actions
 A0015502	Visual inspection

1.2.5 Symbols in graphics

Symbol	Meaning
1, 2, 3, 4, ...	Item numbers
1. , 2. , ...	Series of steps
A, B, C, D, ...	Views

1.2.6 Symbols at the device

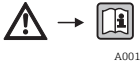
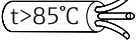
Symbol	Meaning
 A0019159	Safety instructions Observe the safety instructions contained in the associated Operating Instructions.
	Connecting cable immunity to temperature change Indicates that the connecting cables have to withstand a temperature of 85°C at least.

1.2.7 Registered trademarks

KALREZ[®], VITON[®], TEFLON[®]
Registered label of E.I. Du Pont de Nemours & Co., Wilmington, USA

TRI-CLAMP[®]
Registered label of Ladish & Co., Inc., Kenosha, USA

FOUNDATION[™] Fieldbus
Registered trademark of the FieldComm Group, Austin, USA

GORE-TEX[®]
Registered label of W.L. Gore & Associates, Inc., USA

2 Basic safety instructions

2.1 Requirements concerning the staff

The personnel for installation, commissioning, diagnostics and maintenance must fulfill the following requirements:

- Trained, qualified specialists: must have a relevant qualification for this specific function and task
- Are authorized by the plant owner/operator
- Are familiar with federal/national regulations
- Before beginning work, the specialist staff must have read and understood the instructions in the Operating Instructions and supplementary documentation as well as in the certificates (depending on the application)
- Following instructions and basic conditions

The operating personnel must fulfill the following requirements:

- Being instructed and authorized according to the requirements of the task by the facility's owner-operator
- Following the instructions in these Operating Instructions

2.2 Designated use

The **Cerabar M** is a pressure transmitter for measuring level and pressure.

The **Deltabar M** is a differential pressure transmitter for measuring differential pressure, flow and level.

The **Deltapilot M** is a hydrostatic pressure sensor for measuring level and pressure.

2.2.1 Incorrect use

The manufacturer is not liable for damage caused by improper or non-designated use.

Verification for borderline cases:

For special fluids and fluids for cleaning, Endress+Hauser is glad to provide assistance in verifying the corrosion resistance of fluid-wetted materials, but does not accept any warranty or liability.

2.3 Workplace safety

For work on and with the device:

- Wear the required personal protective equipment according to federal/national regulations.
- Switch off the supply voltage before connecting the device.

2.4 Operational safety

Risk of injury!

- ▶ Operate the device in proper technical condition and fail-safe condition only.
- ▶ The operator is responsible for interference-free operation of the device.
- ▶ Only disassemble the device in pressurless condition!

Conversions to the device

Unauthorized modifications to the device are not permitted and can lead to unforeseeable dangers:

- ▶ If, despite this, modifications are required, consult with Endress+Hauser.

Repair

To ensure continued operational safety and reliability,

- ▶ Carry out repairs on the device only if they are expressly permitted.
- ▶ Observe federal/national regulations pertaining to repair of an electrical device.
- ▶ Use original spare parts and accessories from Endress+Hauser only.

2.5 Hazardous area

To eliminate a danger for persons or for the facility when the device is used in the hazardous area (e.g. explosion protection, pressure vessel safety):

- Based on the nameplate, check whether the ordered device is permitted for the intended use in the hazardous area.
- Observe the specifications in the separate supplementary documentation that is an integral part of these Instructions.

2.6 Product safety

This measuring device is designed in accordance with good engineering practice to meet state-of-the-art safety requirements, has been tested, and left the factory in a condition in which they are safe to operate. It fulfills general safety requirements and legal requirements. It also conforms to the EC directives listed in the device-specific EC declaration of conformity. Endress+Hauser confirms this fact by applying the CE mark.

3 Identification

3.1 Product identification

The following options are available for identification of the measuring device:

- Nameplate specifications
- Order code with breakdown of the device features on the delivery note
- Enter serial numbers from nameplates in W@M Device Viewer (www.endress.com/deviceviewer): All information about the measuring device is displayed.

For an overview of the technical documentation provided, enter the serial number from the nameplates in the W@M Device Viewer (www.endress.com/deviceviewer).

3.2 Device designation

3.2.1 Nameplate

- The MWP (maximum working pressure) is specified on the nameplate. This value refers to a reference temperature of 20°C (68°F) or 100°F (38 °C) for ANSI flanges.
- The pressure values permitted at higher temperatures can be found in the following standards:
 - EN 1092-1: 2001 Tab. 18 ¹⁾
 - ASME B 16.5a – 1998 Tab. 2-2.2 F316
 - ASME B 16.5a – 1998 Tab. 2.3.8 N10276
 - JIS B 2220
- The test pressure corresponds to the over pressure limit (OPL) of the device = MWP x 1.5 ²⁾.
- The Pressure Equipment Directive (EC Directive 97/23/EC) uses the abbreviation "PS". The abbreviation "PS" corresponds to the MWP (maximum working pressure) of the measuring device.

- 1) With regard to their stability-temperature property, the materials 1.4435 and 1.4404 are grouped together under 13EO in EN 1092-1 Tab. 18. The chemical composition of the two materials can be identical.
- 2) The equation does not apply for PMP51 and PMP55 with a 40 bar (600 psi) or a 100 bar (1500 psi) measuring cell.

Aluminum housing

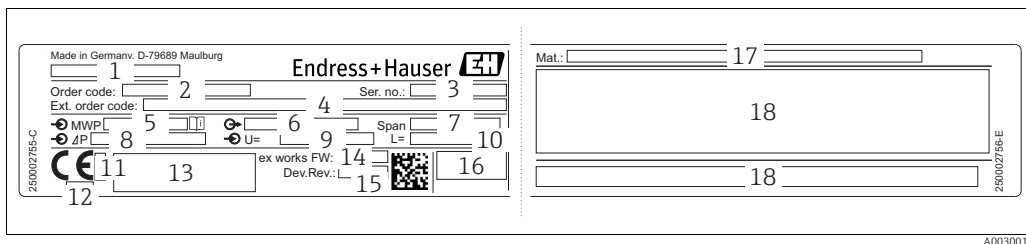

Fig. 1: Nameplate

- 1 Device name
- 2 Order code (for re-orders)
- 3 Serial number (for identification)
- 4 Extended order code (complete)
- 5 MWP (maximum working pressure)
- 6 Electronic version (output signal)
- 7 Min./max. span
- 8 Nominal measuring range
- 9 Supply voltage
- 10 Unit of length
- 11 ID number of notified body with regard to ATEX (optional)
- 12 ID number of notified body with regard to Pressure Equipment Directive (optional)
- 13 Approvals
- 14 Device version
- 15 Software version
- 16 Degree of protection
- 17 Wetted materials
- 18 Approval-specific information

Devices suitable for oxygen applications are fitted with an additional nameplate.

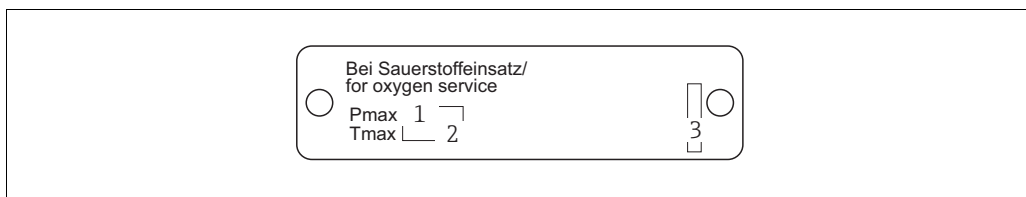

Fig. 2: Additional nameplate for devices suitable for oxygen applications

- 1 Maximum pressure for oxygen applications
- 2 Maximum temperature for oxygen applications
- 3 Layout identification of the nameplate

Stainless steel housing, hygienic

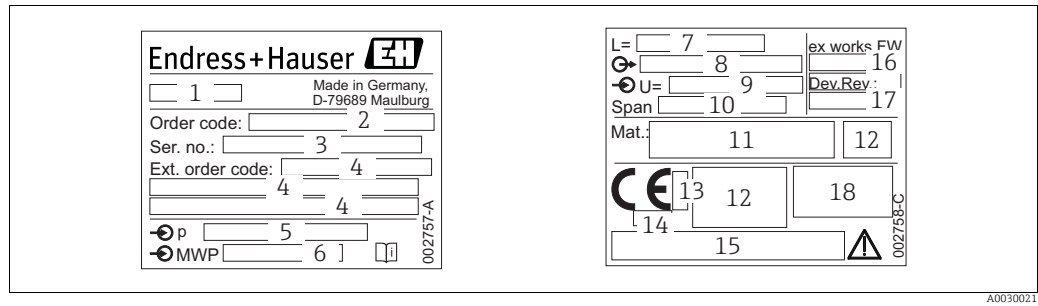

Fig. 3: Nameplate for Cerabar M and Deltapilot M

- 1 Device name
- 2 Order code (for re-orders)
- 3 Serial number (for identification)
- 4 Extended order code (complete)
- 5 Nominal measuring range
- 6 MWP (maximum working pressure)
- 7 Length data
- 8 Electronic version (output signal)
- 9 Supply voltage
- 10 Min./max. span
- 11 Wetted materials
- 12 Approval-specific information
- 13 ID number of notified body with regard to ATEX (optional)
- 14 ID number of notified body with regard to Pressure Equipment Directive (optional)
- 15 Approvals
- 16 Software version
- 17 Device version
- 18 Degree of protection

Devices with certificates are fitted with an additional plate.

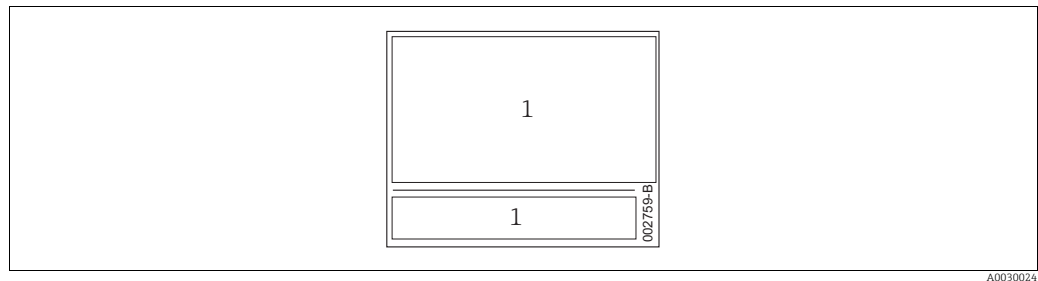

Fig. 4: Additional nameplate for devices with certificates

- 1 Approval-specific information

3.2.2 Identifying the sensor type

In the case of gauge pressure sensors, the "Pos. zero adjust" parameter appears in the operating menu ("Setup" -> "Pos. zero adjust").

In the case of absolute pressure sensors, the "Calib. offset" parameter appears in the operating menu ("Setup" -> "Calib. offset").

3.3 Scope of delivery

The scope of delivery comprises:

- Device
- Optional accessories

Documentation supplied:

- The Operating Instructions BA00384P is available on the Internet.
→ See: www.endress.com → Download
- Brief Operating Instructions: KA01032P Cerabar M / KA01029P Deltabar M / KA01035P Deltapilot M
- Final inspection report
- Additional Safety Instructions for ATEX, IECEx and NEPSI devices
- Optional: factory calibration form, test certificates

3.4 CE mark, Declaration of Conformity

The devices are designed to meet state-of-the-art safety requirements, have been tested and left the factory in a condition in which they are safe to operate. The devices comply with the applicable standards and regulations as listed in the EC Declaration of Conformity and thus comply with the statutory requirements of the EC Directives. Endress+Hauser confirms the conformity of the device by affixing to it the CE mark.

4 Installation

4.1 Incoming acceptance

- Check the packaging and the contents for damage.
- Check the shipment, make sure nothing is missing and that the scope of supply matches your order.

4.2 Storage and transport

4.2.1 Storage

The device must be stored in a dry, clean area and protected against damage from impact (EN 837-2).

Storage temperature range:

See Technical Information for Cerabar M TI00436P / Deltabar M TI00434P / Deltapilot M TI00437P.

4.2.2 Transport

▲ WARNING

Incorrect transportation

Housing, diaphragm and capillaries may become damaged, and there is a risk of injury!

- ▶ Transport the measuring device to the measuring point in its original packaging or by the process connection.
- ▶ Follow the safety instructions and transport conditions for devices weighing more than 18 kg (39.6 lbs).
- ▶ Do not use capillaries as a carrying aid for the diaphragm seals.

4.3 Installation conditions

4.3.1 Dimensions

→ For dimensions, please refer to the Technical Information for Cerabar M TI00436P / Deltabar M TI00434P / Deltapilot M TI00437P, "Mechanical construction" section.

4.4 General installation instructions

- Devices with a G 1 1/2 thread:
When screwing the device into the tank, the flat seal has to be positioned on the sealing surface of the process connection. To avoid additional strain on the process isolating diaphragm, the thread should never be sealed with hemp or similar materials.
- Devices with NPT threads:
 - Wrap Teflon tape around the thread to seal it.
 - Tighten the device at the hexagonal bolt only. Do not turn at the housing.
 - Do not overtighten the thread when screwing. Max. torque: 20 to 30 Nm (14.75 to 22.13 lbf ft)

4.4.1 Mounting sensor modules with PVDF thread

▲ WARNING

Risk of damage to process connection!

Risk of injury!

- ▶ Sensor modules with PVDF process connections with threaded connection must be installed with the mounting bracket provided!

▲ WARNING

Material fatigue from pressure and temperature!

Risk of injury if parts burst! The thread can become loose if exposed to high pressure and temperatures.

- ▶ The integrity of the thread must be checked regularly and the thread may need to be re-tightened with the maximum tightening torque of 7 Nm (5.16 lbf ft). Teflon tape is recommended for sealing the 1/2" NPT thread.

4.5 Installing Cerabar M

- Due to the orientation of the Cerabar M, there may be a shift in the zero point, i.e. when the container is empty or partially full, the measured value does not display zero. You can correct this zero point shift → [47](#), Section "Function of the operating elements" or → [73](#), Section 8.3 "Pos. zero adjust".
- For PMP55, please refer to Section 4.5.2 "Installation instructions for devices with diaphragm seals – PMP55", → [17](#).
- Endress+Hauser offers a mounting bracket for installing on pipes or walls. → [21](#), Section 4.5.5 "Wall and pipe mounting (optional)".

4.5.1 Installation instructions for devices without diaphragm seals – PMP51, PMC51

NOTICE

Damage to the device!

If a heated Cerabar M is cooled during the cleaning process (e.g. by cold water), a vacuum develops for a short time, whereby moisture can penetrate the sensor through the pressure compensation (1).

- ▶ If this is the case, mount the Cerabar M with the pressure compensation (1) pointing downwards.

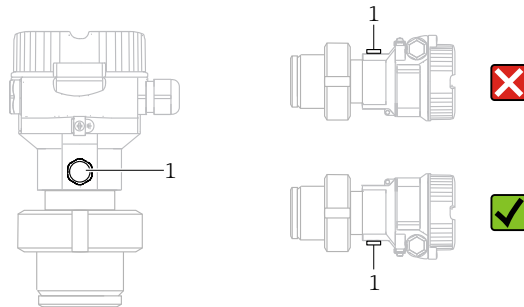

- Keep the pressure compensation and GORE-TEX® filter (1) free from contamination.
- Cerabar M transmitters without diaphragm seals are mounted as per the norms for a manometer (DIN EN 837-2). We recommend the use of shutoff devices and siphons. The orientation depends on the measuring application.
- Do not clean or touch process isolating diaphragms with hard or pointed objects.
- The device must be installed as follows in order to comply with the cleanability requirements of the ASME-BPE (Part SD Cleanability):

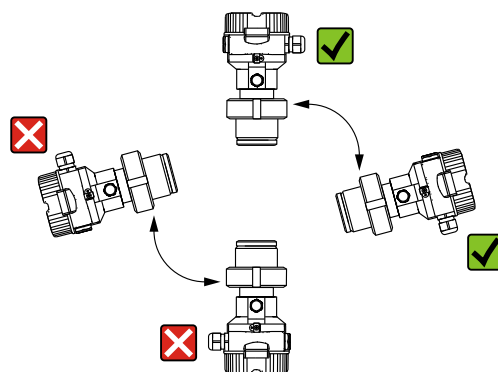

Pressure measurement in gases

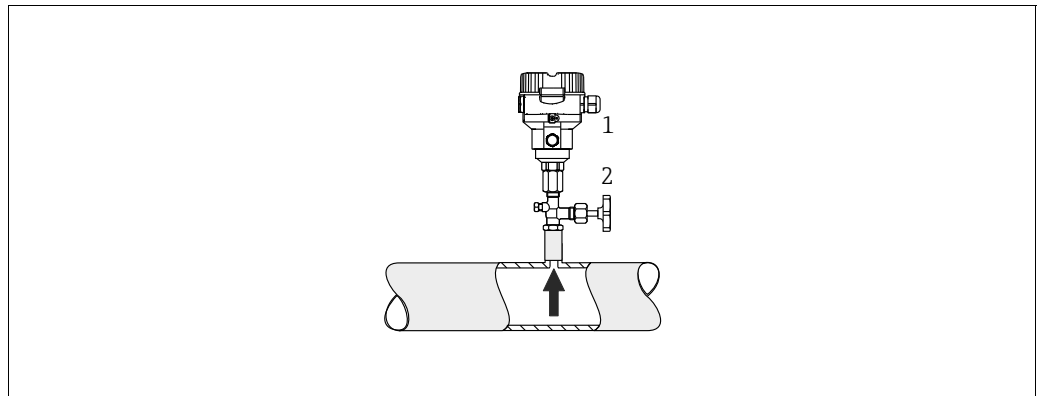

Fig. 5: Measuring arrangement for pressure measurement in gases

- 1 Cerabar M
- 2 Shutoff device

Mount the Cerabar M with the shutoff device above the tapping point so that any condensate can flow into the process.

Pressure measurement in steams

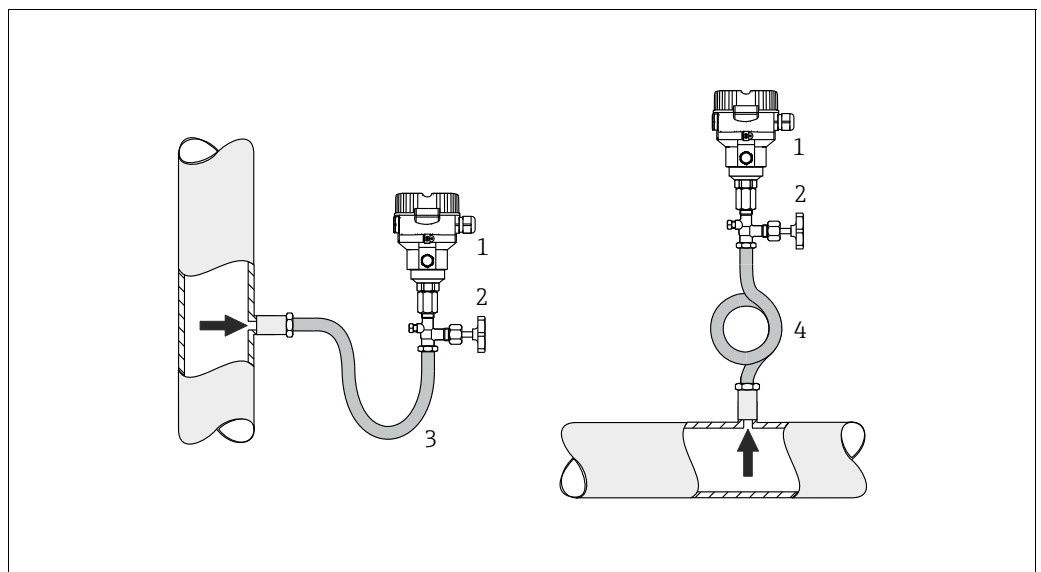

Fig. 6: Measuring arrangement for pressure measurement in steams

- 1 Cerabar M
- 2 Shutoff device
- 3 U-shaped siphon
- 4 Circular siphon

- Mount Cerabar M with siphon above the tapping point.
- Fill the siphon with liquid before commissioning.
The siphon reduces the temperature to almost the ambient temperature.

Pressure measurement in liquids

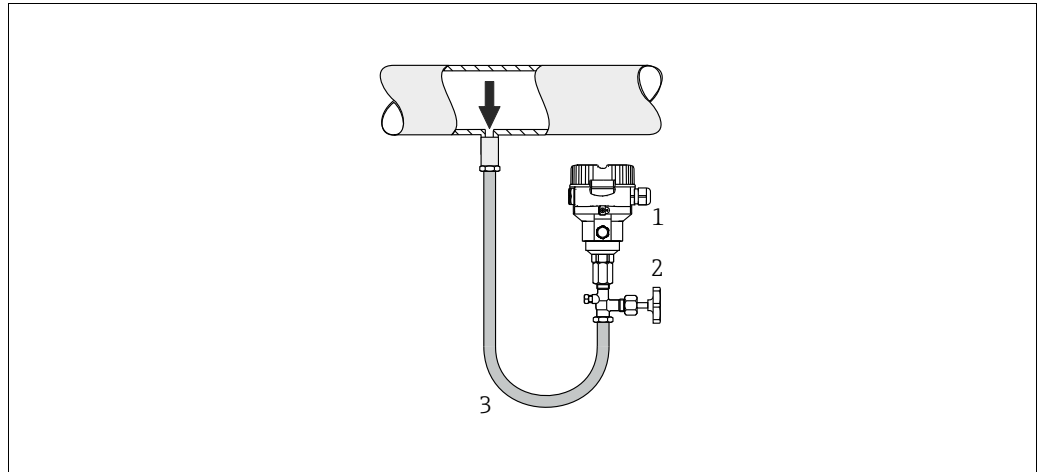

Fig. 7: Measuring arrangement for pressure measurement in liquids

- 1 Cerabar M
- 2 Shutoff device

- Mount Cerabar M with shutoff device below or at the same level as the tapping point.

Level measurement

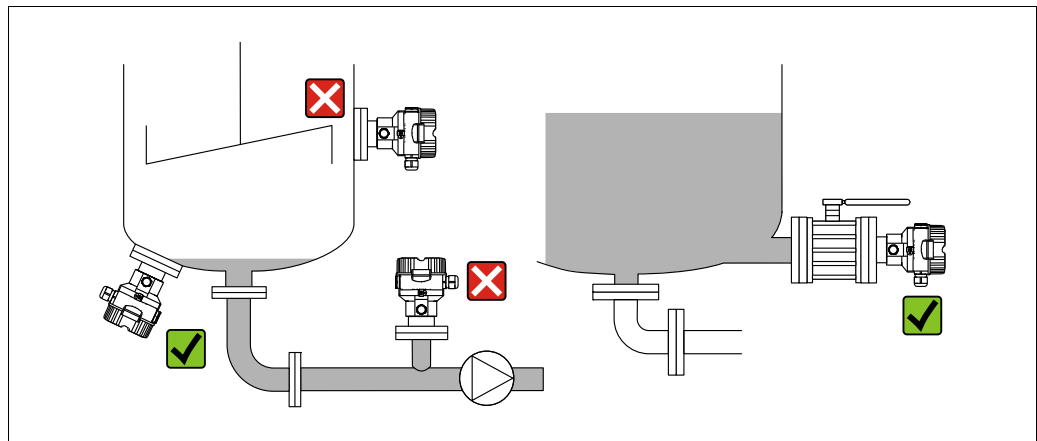

Fig. 8: Measuring arrangement for level

- Always install the Cerabar M below the lowest measuring point.
- Do not mount the device in the filling curtain or at a point in the tank which could be affected by pressure pulses from an agitator.
- Do not mount the device in the suction area of a pump.
- The calibration and functional test can be carried out more easily if you mount the device downstream of a shutoff device.

4.5.2 Installation instructions for devices with diaphragm seals – PMP55

- Cerabar M devices with diaphragm seals are screwed in, flanged or clamped, depending on the type of diaphragm seal.
- Please note that the hydrostatic pressure of the liquid columns in the capillaries can cause zero point shift. The zero point shift can be corrected.
- Do not clean or touch the process isolating diaphragm of the diaphragm seal with hard or pointed objects.
- Do not remove process isolating diaphragm protection until shortly before installation.

NOTICE

Improper handling!

Damage to the device!

- ▶ A diaphragm seal and the pressure transmitter together form a closed, oil-filled calibrated system. The fill fluid hole is sealed and may not be opened.
- ▶ When using a mounting bracket, sufficient strain relief must be ensured for the capillaries in order to prevent the capillary bending down (bending radius ≥ 100 (3.94 in)).
- ▶ Please observe the application limits of the diaphragm seal filling oil as detailed in the Technical Information for Cerabar M TI00436P, "Planning instructions for diaphragm seal systems" section.

NOTICE

In order to obtain more precise measurement results and to avoid a defect in the device, mount the capillaries as follows:

- ▶ Vibration-free (in order to avoid additional pressure fluctuations)
- ▶ Not in the vicinity of heating or cooling lines
- ▶ Insulate if the ambient temperature is below or above the reference temperature
- ▶ With a bending radius of ≥ 100 mm (3.94 in).
- ▶ Do not use the capillaries as a carrying aid for the diaphragm seals!

Vacuum application

For applications under vacuum, Endress+Hauser recommends mounting the pressure transmitter below the diaphragm seal. This prevents vacuum loading of the diaphragm seal caused by the presence of fill fluid in the capillary.

When the pressure transmitter is mounted above the diaphragm seal, the maximum height difference H1 in accordance with the illustrations below must not be exceeded.

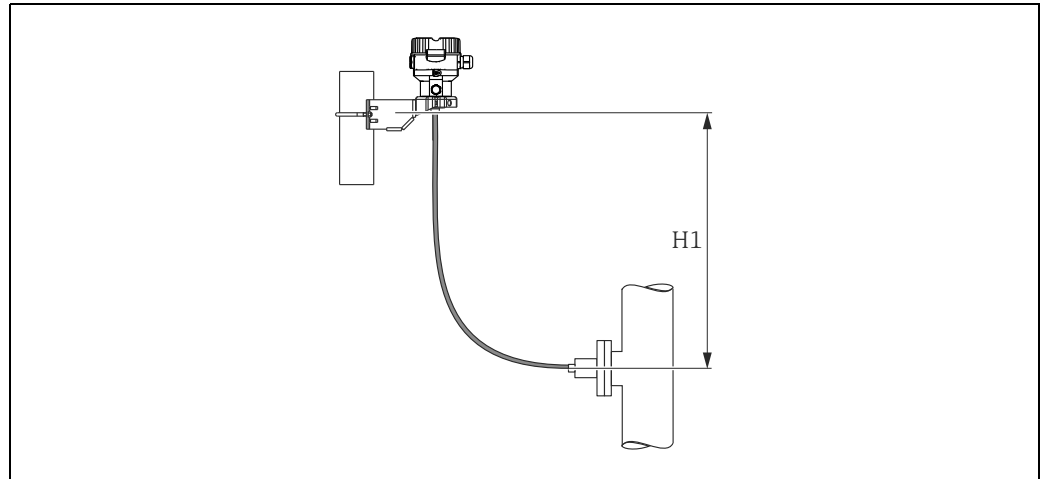

Fig. 9: Installation above the lower diaphragm seal

The maximum height difference depends on the density of the filling oil and the smallest ever pressure that is permitted to occur at the diaphragm seal (empty vessel), see illustration below:

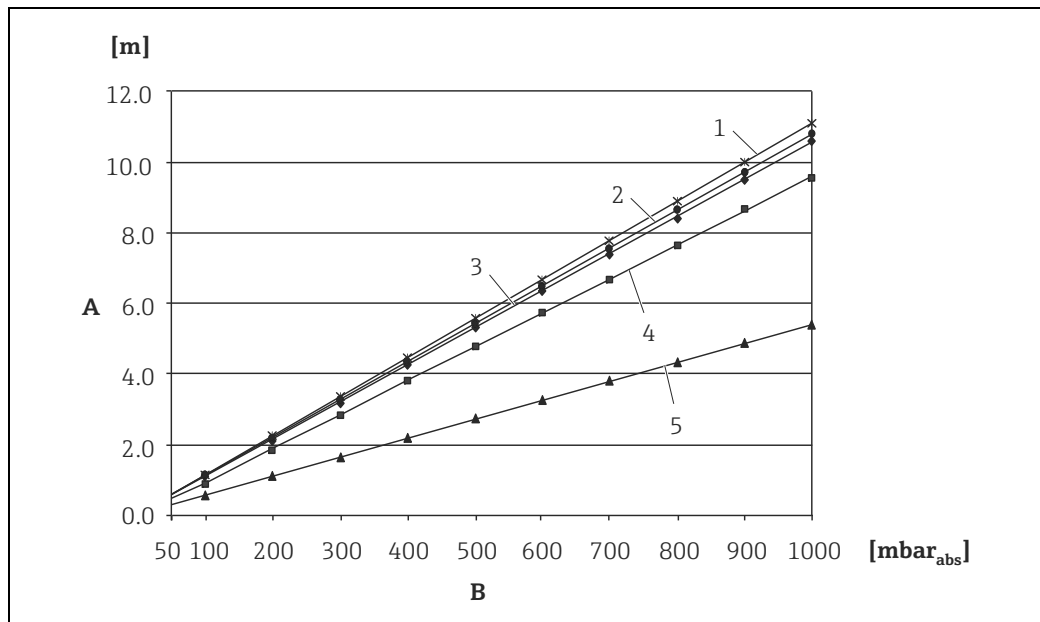

Fig. 10: Diagram of maximum installation height above the lower diaphragm seal for vacuum applications depending on the pressure at the diaphragm seal on the positive side

- A Height difference H1
- B Pressure at diaphragm seal
- 1 Low temperature oil
- 2 Vegetable oil
- 3 Silicone oil
- 4 High-temperature oil
- 5 Inert oil

Mounting with temperature isolator

Endress+Hauser recommends the use of temperature isolators in the event of constant extreme medium temperatures which lead to the maximum permissible electronics temperature of +85 °C (+185°F) being exceeded.

Depending on the filling oil used, diaphragm seal systems with temperature isolators can be used for maximum temperatures of up to 400 °C (+752 °F). → For the temperature application limits, see technical Information, "Diaphragm seal filling oils" section.

To minimize the influence of rising heat, Endress+Hauser recommends the device be mounted horizontally or with the housing pointing downwards. The additional installation height also brings about a maximum zero point shift of 21 mbar (0.315 psi) due to the hydrostatic column in the temperature isolator. You can correct this zero point shift at the device.

The temperature restrictions are lowest with an insulation height of 30 mm (1.18 inch).

Full insulation exhibits virtually the same behavior as no insulation!

The temperature limits with an insulation height of 30 mm (1.18 inch) are illustrated in the following graphic.

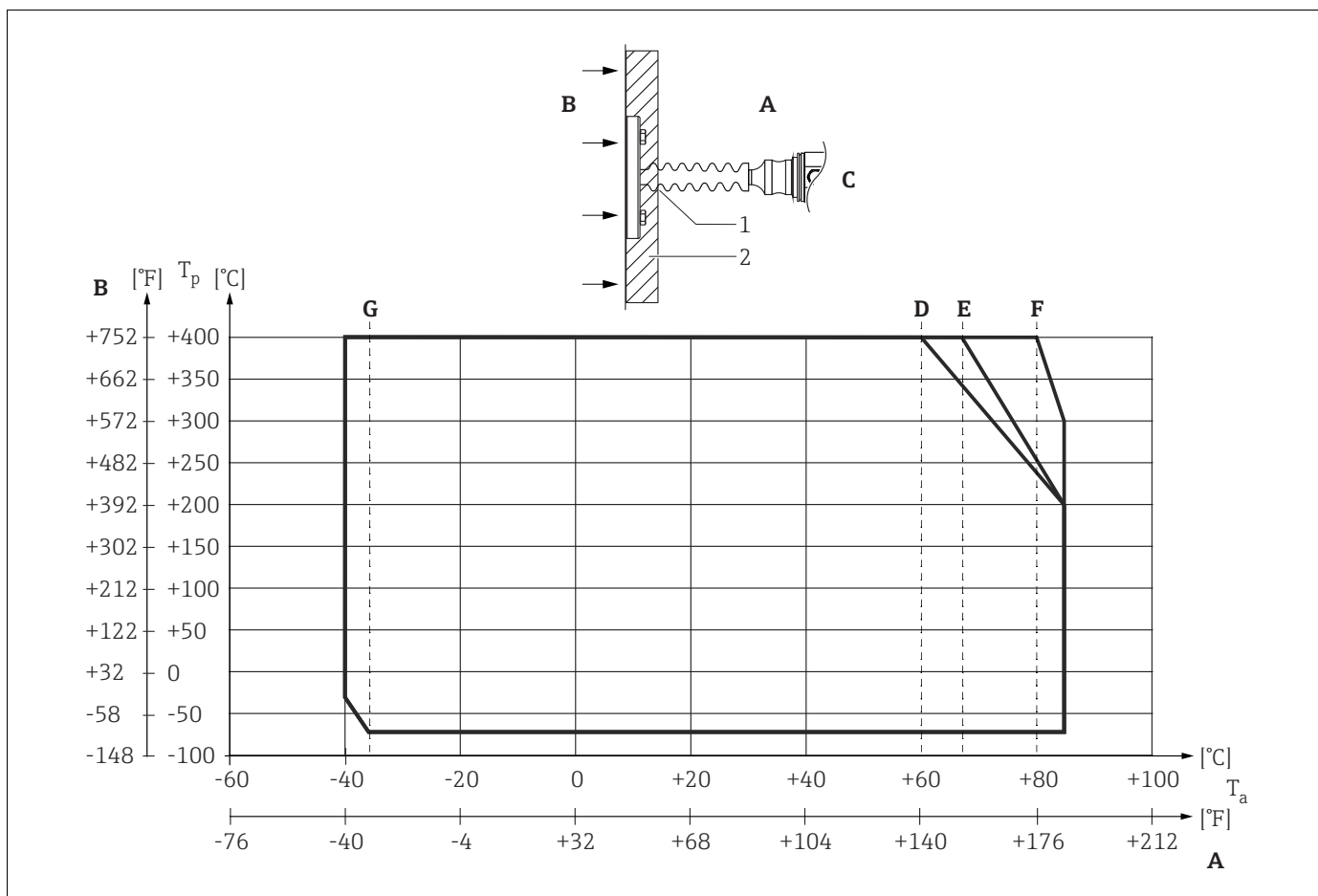

Fig. 11:

- A Ambient temperature: ≤ 85 °C (185 °F)
- B Process temperature: max. 400 °C (752 °F), depending on the filling oil used
- C Device with temperature isolator, material 316L (1.4404)
- D Without isolation
- E Maximum isolation
- F 30 mm (1.18. inch) isolation
- G Without isolation, maximum isolation, 30 mm (1.18. inch) isolation
- 1 Isolation height 30 mm (1.18. inch)
- 2 Isolation material

4.5.3 Seal for flange mounting

NOTICE

Corrupted measurement results.

The seal is not allowed to press against the process isolating diaphragm as this could affect the measurement result.

- ▶ Ensure that the seal is not touching the process isolating diaphragm.

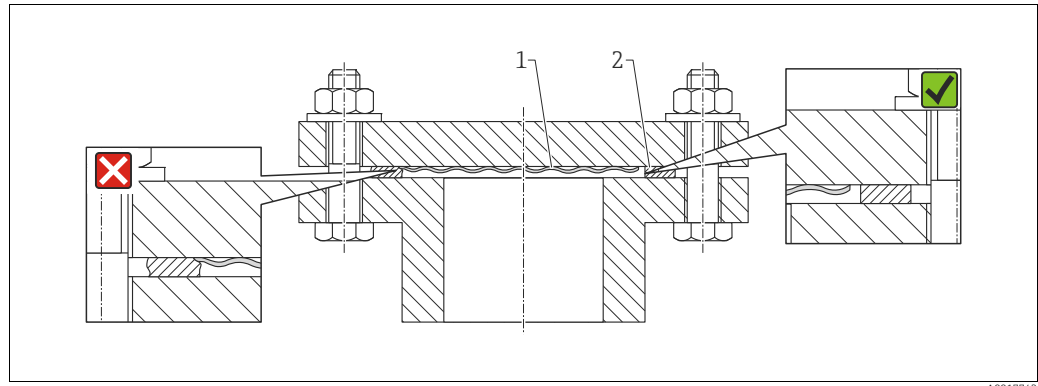

Fig. 12:
 1 Process isolating diaphragm
 2 Seal

4.5.4 Thermal insulation – PMP55

The PMP55 may only be insulated up to a certain height. The maximum permitted insulation height is indicated on the devices and applies to an insulation material with a heat conductivity $\leq 0.04 \text{ W}/(\text{m} \times \text{K})$ and to the maximum permitted ambient and process temperature. The data were determined under the most critical application "quiescent air".

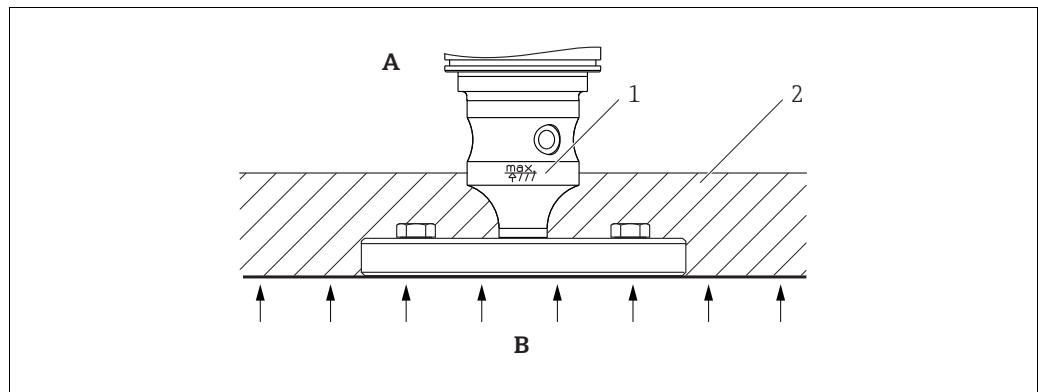
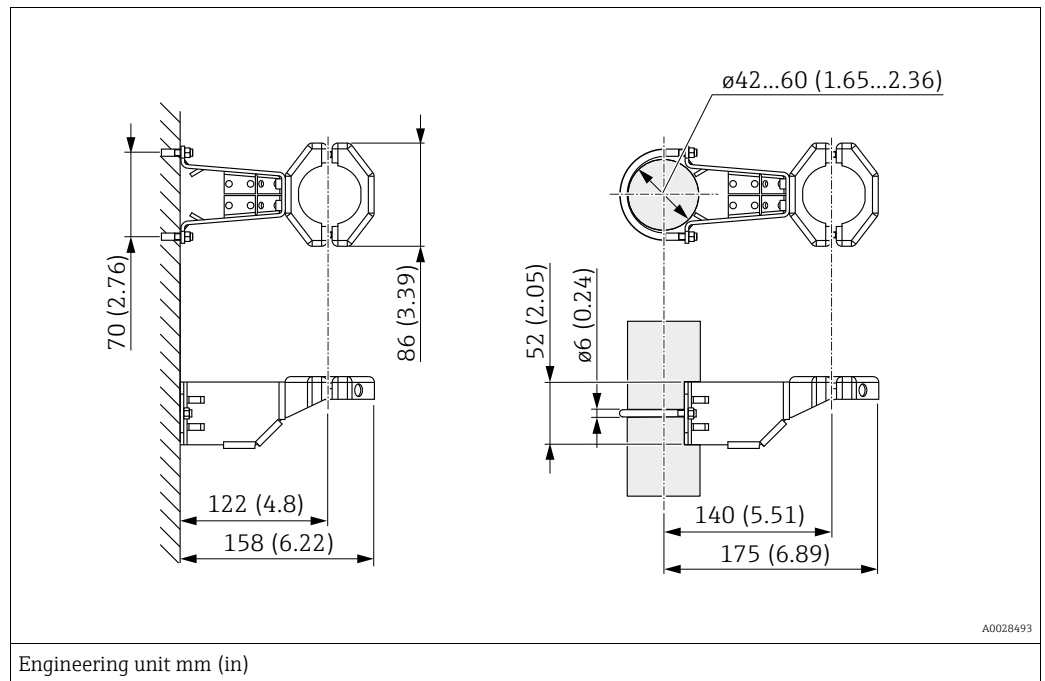

Fig. 13: Maximum permitted insulation height, here indicated on a PMP55 with a flange
 A Ambient temperature: $\leq 70 \text{ }^\circ\text{C}$ (158°F)
 B Process temperature: max. $400 \text{ }^\circ\text{C}$ (752°F), depending on the diaphragm seal filling oil used
 1 Maximum permitted insulation height
 2 Insulation material

4.5.5 Wall and pipe mounting (optional)

Endress+Hauser offers a mounting bracket for installation on pipes or walls (for pipe diameters from 1 ¼" to 2").



Please note the following when mounting:

- Devices with capillary tubes: mount capillaries with a bending radius ≥ 100 mm (3.94 in).
- When mounting on a pipe, tighten the nuts on the bracket uniformly with a torque of at least 5 Nm (3.69 lbs ft).

4.5.6 Assembling and mounting the "separate housing" version

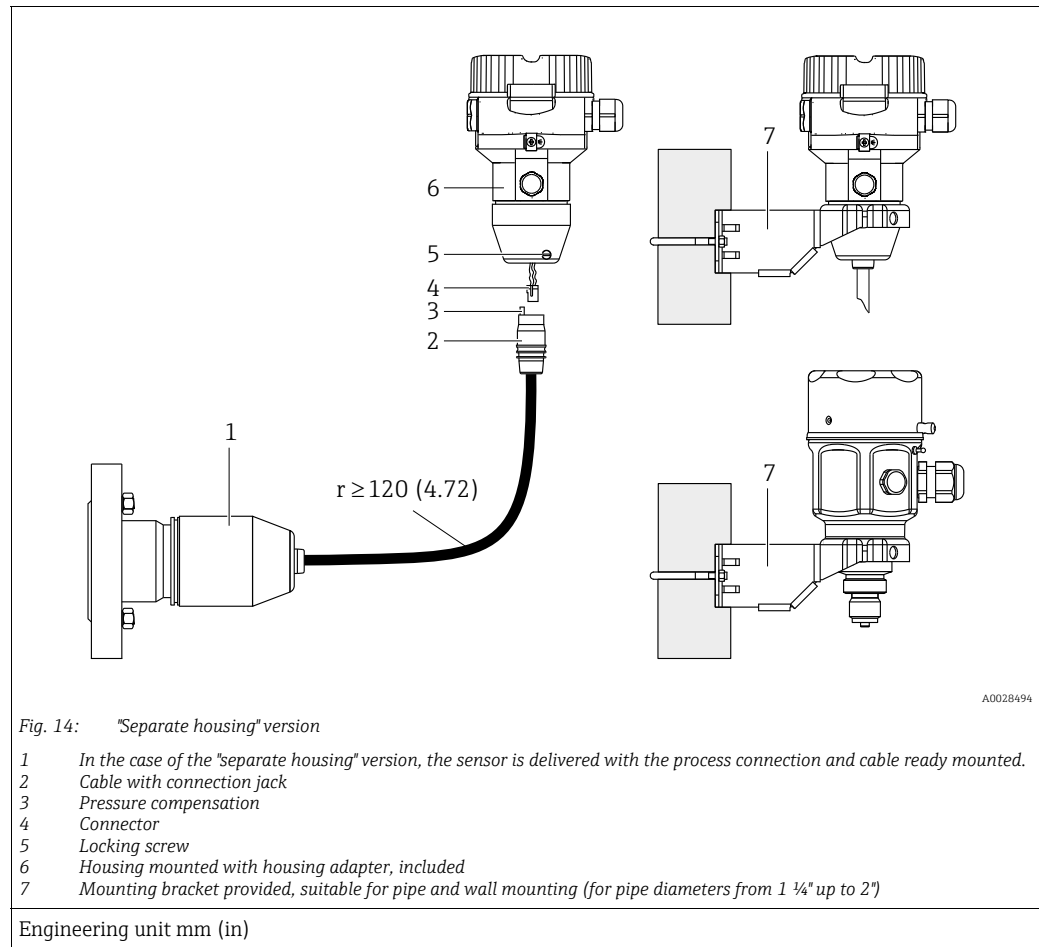

Assembly and mounting

1. Insert the connector (item 4) into the corresponding connection jack of the cable (item 2).
2. Plug the cable into the housing adapter (item 6).
3. Tighten the locking screw (item 5).
4. Mount the housing on a wall or pipe using the mounting bracket (item 7).
 When mounting on a pipe, tighten the nuts on the bracket uniformly with a torque of at least 5 Nm (3.69 lbs ft).
 Mount the cable with a bending radius (r) ≥ 120 mm (4.72 in).

Routing the cable (e.g. through a pipe)

You require the cable shortening kit.

Order number: 71093286

For details on mounting, see SD00553P/00/A6.

4.5.7 PMP51, version prepared for diaphragm seal mount – welding recommendation

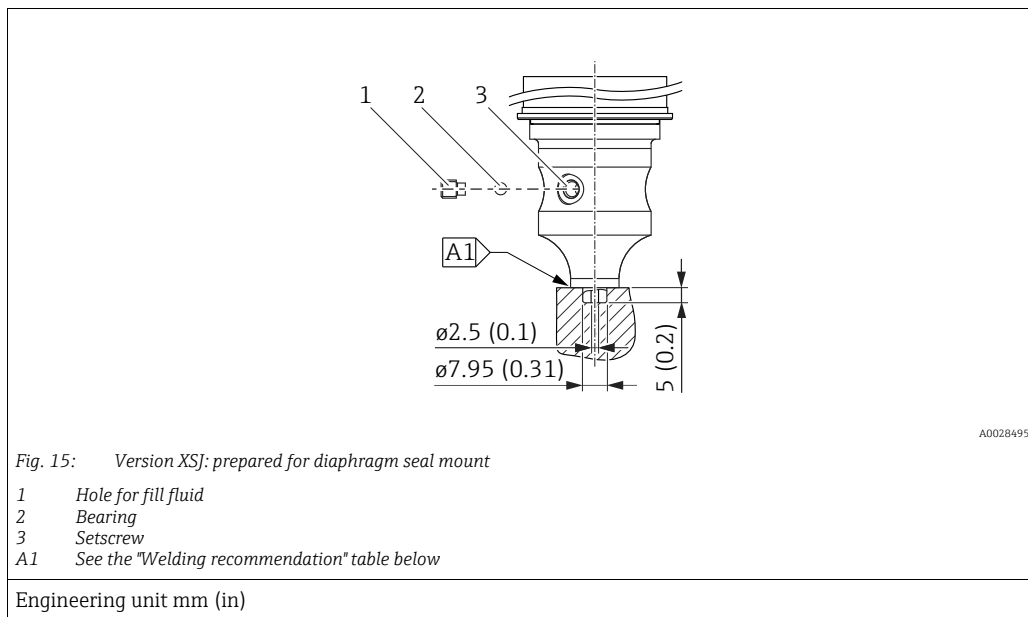

Endress+Hauser recommends welding on the diaphragm seal as follows for the "XSJ - prepared for diaphragm seal mount" version in feature 110 "Process connection" in the order code up to, and including, 40 bar (600 psi) sensors: the total welding depth of the fillet weld is 1 mm (0.04 in) with an outer diameter of 16 mm (0.63 in). Welding is performed according to the WIG method.

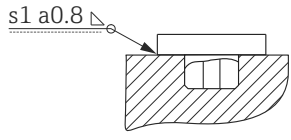
Consecutive seam no.	Sketch/welding groove shape, dimension as per DIN 8551	Base material matching	Welding method DIN EN ISO 24063	Welding position	Inert gas, additives
A1 for sensors ≤ 40 bar (600 psi)		Adapter made of AISI 316L (1.4435) to be welded to diaphragm seal made of AISI 316L (1.4435 or 1.4404)	141	PB	Inert gas Ar/H 95/5 Additive: ER 316L Si (1.4430)

Information on filling

The diaphragm seal must be filled as soon as it has been welded on.

- After welded into the process connection, the sensor assembly must be properly filled with a filling oil and sealed gas-tight with a sealing ball and lock screw. Once the diaphragm seal has been filled, at the zero point the device display should not exceed 10% of the full scale value of the cell measuring range. The internal pressure of the diaphragm seal must be corrected accordingly.
- Adjustment / calibration:
 - The device is operational once it has been fully assembled.
 - Perform a reset. The device must then be calibrated to the process measuring range as described in the Operating Instructions.

4.6 Installing Deltabar M

NOTICE

Incorrect handling!

Damage of the device!

- ▶ Disassembly of the screws with item number (1) is not permissible under any circumstances and will result in loss of warranty.

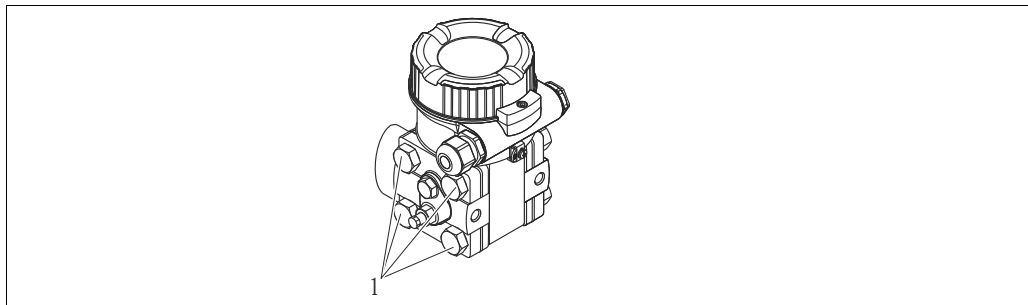

4.6.1 Installation position

- Due to the orientation of the Deltabar M, there may be a shift in the measured value, i.e. when the container is empty, the measured value does not display zero. You may correct this zero point shift by a position adjustment in one of the following ways:
 - via the operation keys on the electronics module (→ 47, "Function of the operating elements")
 - via the operating menu (→ 73, "Pos. zero adjust")
- General recommendations for routing the impulse piping can be found in DIN 19210 "Methods for measurement of fluid flow; differential piping for flow measurement devices" or the corresponding national or international standards.
- Using a three-valve or five-valve manifold allows for easy commissioning, installation and maintenance without interrupting the process.
- When routing the impulse piping outdoors, ensure that sufficient anti-freeze protection is used, e.g. by using pipe heat tracing.
- Install the impulse piping with a monotonic gradient of at least 10%.
- Endress+Hauser offers a mounting bracket for installing on pipes or walls (→ 29, "Wall and pipe-mounting (option)").

Installation position for flow measurement



For more information about differential pressure flow measurement refer to following documents:

- Differential pressure flow measurements with orifices: Technical Information TI00422P
- Differential pressure flow measurement with Pitot tubes: Technical Information TI00425P

Flow measurement in gases

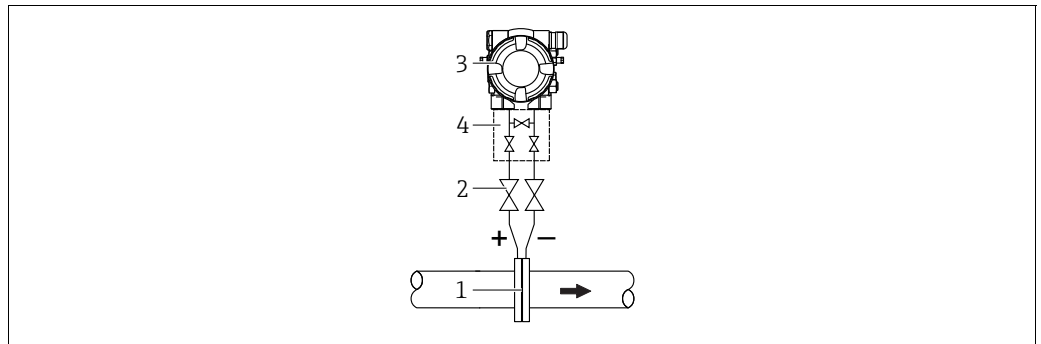

A0029783

Measuring layout for flow measurement in gases

- 1 Orifice plate or pitot tube
- 2 Shut-off valves
- 3 Deltabar M
- 4 Three-valve manifold

- Mount the Deltabar M above the measuring point so that the condensate which may be present, can run off into the process piping.

Flow measurement in steam

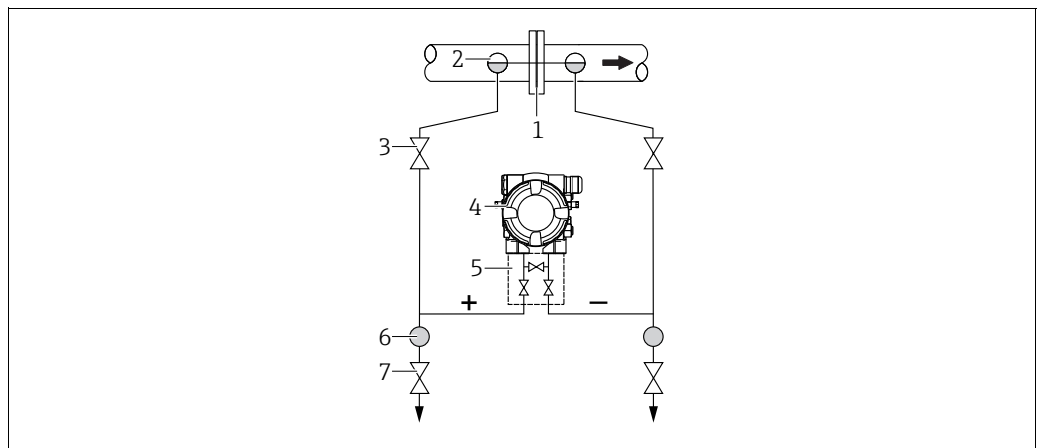

A0029784

Measuring layout for flow measurement in steam

- 1 Orifice plate or pitot tube
- 2 Condensate traps
- 3 Shut-off valves
- 4 Deltabar M
- 5 Three-valve manifold
- 6 Separator
- 7 Drain valves

- Mount the Deltabar M below the measuring point.
- Mount the condensate traps at the same level as the tapping points and at the same distance to the Deltabar M.
- Prior to commissioning, fill the impulse piping to the height of the condensate traps.

Flow measurement in liquids

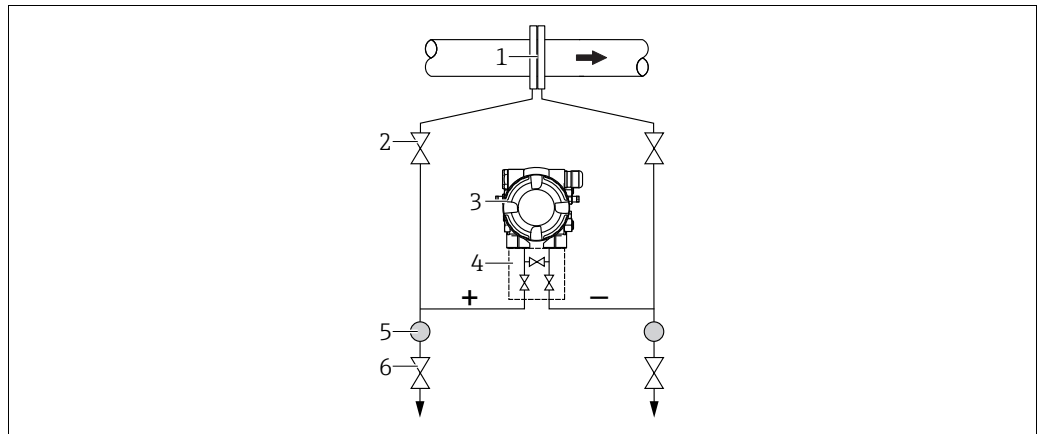

A0029785

Measuring layout for flow measurement in liquids

- 1 Orifice plate or pitot tube
- 2 Shut-off valves
- 3 Deltabar M
- 4 Three-valve manifold
- 5 Separator
- 6 Drain valves

- Mount the Deltabar M below the measuring point so that the impulse piping is always filled with liquid and gas bubbles can run back into the process piping.
- When measuring in media with solid parts, such as dirty liquids, installing separators and drain valves is useful for capturing and removing sediment.

Installation position for level measurement

Level measurement in an open container

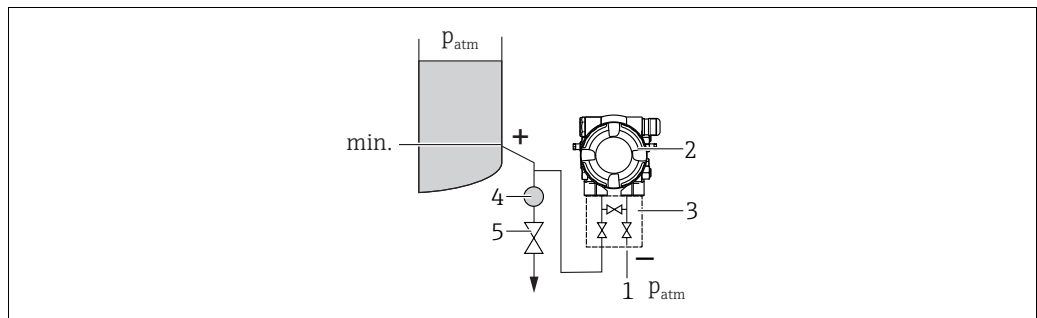

A0029787

Measuring layout for level measurement in open containers

- 1 The low-pressure side is open to atmospheric pressure
- 2 Deltabar M
- 3 Three-valve manifold
- 4 Separator
- 5 Drain valve

- Mount the Deltabar M below the lower measuring connection so that the impulse piping is always filled with liquid.
- The low-pressure side is open to atmospheric pressure.
- When measuring in media with solid parts, such as dirty liquids, installing separators and drain valves is useful for capturing and removing sediment.

Level measurement in a closed container

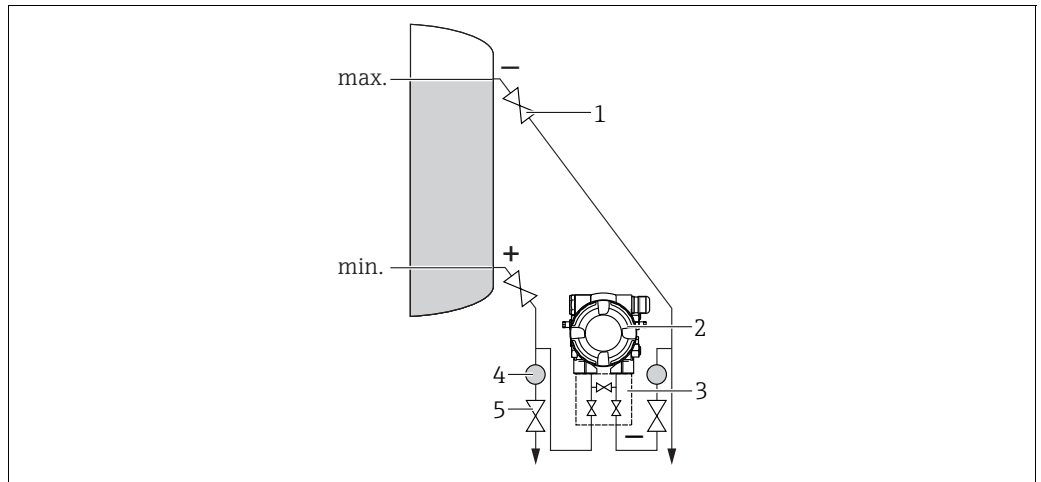

Measuring layout for level measurement in a closed container

- 1 Shut-off valves
- 2 Deltabar M
- 3 Three-valve manifold
- 4 Separator
- 5 Drain valves

- Mount the Deltabar M below the lower measuring connection so that the impulse piping is always filled with liquid.
- Always connect the low-pressure side above the maximum level.
- When measuring in media with solid parts, such as dirty liquids, installing separators and drain valves is useful for capturing and removing sediment.

Level measurement in a closed container with superimposed steam

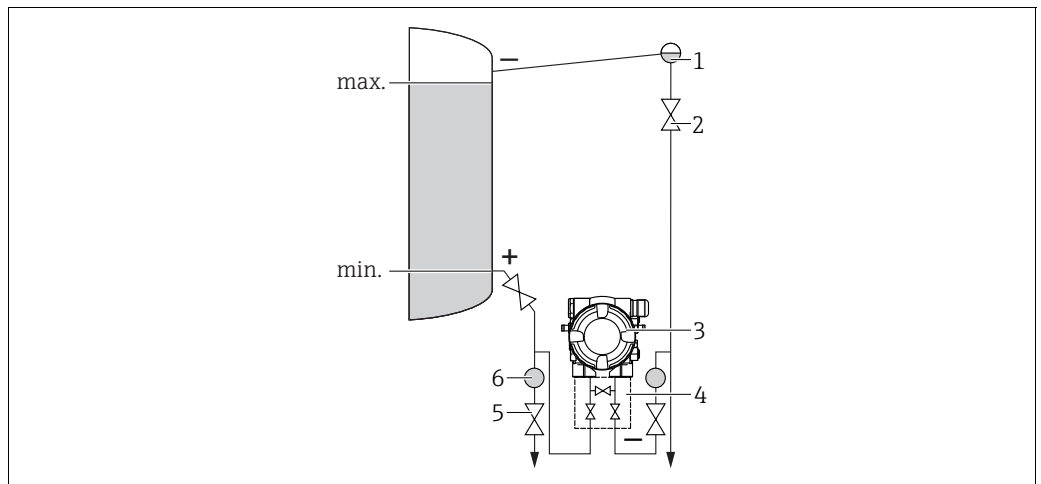

Measuring layout for level measurement in a container with superimposed steam

- 1 Condensate trap
- 2 Shut-off valves
- 3 Deltabar M
- 4 Three-valve manifold
- 5 Separator
- 6 Drain valves

- Mount the Deltabar M below the lower measuring connection so that the impulse piping is always filled with liquid.
- Always connect the low-pressure side above the maximum level.
- A condensate trap ensures constant pressure on the low-pressure side.

- When measuring in media with solid parts, such as dirty liquids, installing separators and drain valves is useful for capturing and removing sediment.

Installation position for differential pressure measurement

Differential pressure measurement in gases and steam

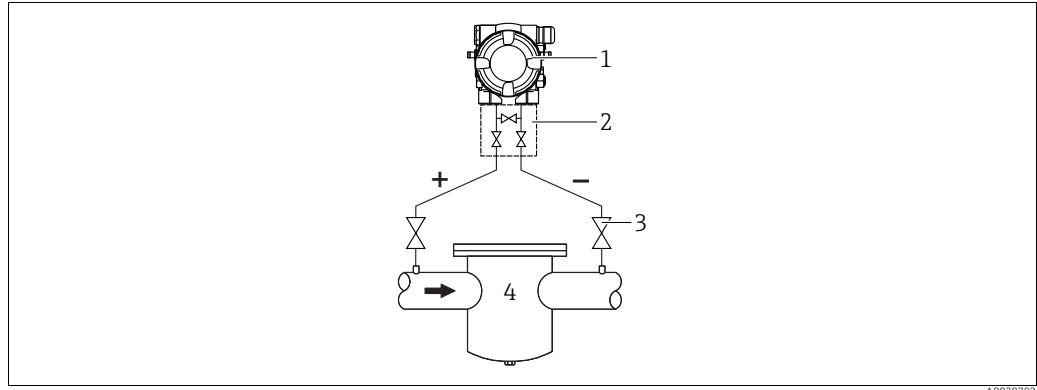

A0029792

Measuring layout for differential pressure measurement in gases and steam

- 1 Deltabar M
- 2 Three-valve manifold
- 3 Shut-off valves
- 4 e.g. filter

- Mount the Deltabar M above the measuring point so that the condensate which may be present, can run off into the process piping.

Differential pressure measurement in liquids

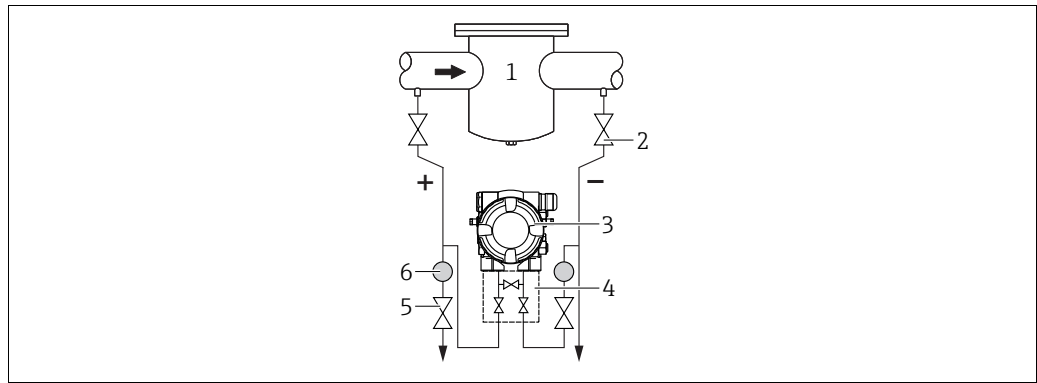

A0029798

Measuring layout for differential pressure measurement in liquids

- 1 e.g. filter
- 2 Shut-off valves
- 3 Deltabar M
- 4 Three-valve manifold
- 5 Separator
- 6 Drain valves

- Mount the Deltabar M below the measuring point so that the impulse piping is always filled with liquid and gas bubbles can run back into the process piping.
- When measuring in media with solid parts, such as dirty liquids, installing separators and drain valves is useful for capturing and removing sediment.

4.6.2 Wall and pipe-mounting (option)

Endress+Hauser offers the following mounting brackets for installing the device on pipes or walls:

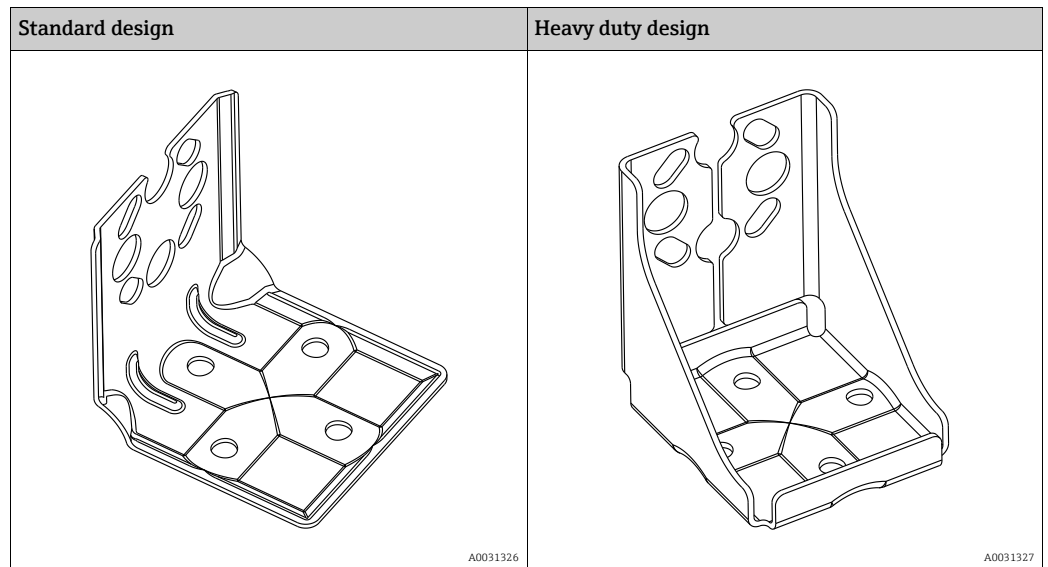

When using a valve block, the block's dimensions must be taken into account.
 Bracket for wall and pipe mounting including retaining bracket for pipe mounting and two nuts.
 material of the screws used to secure the device depend on the order code.
 Technical data (e.g. dimensions or order numbers for screws) see accessory document SD01553P/00/EN.

Please note the following when mounting:

- To prevent the mounting screws from scoring, lubricate them with a multi-purpose grease prior to mounting.
- In the case of pipe mounting, the nuts on the bracket must be tightened uniformly with a torque of at least 30 Nm (22.13 lbf ft).
- For installation purposes, only use the screws with item number (2) (see the following diagram).

NOTICE**Incorrect handling!**

Damage of the device!

- ▶ Disassembly of the screws with item number (1) is not permissible under any circumstances and will result in loss of warranty.

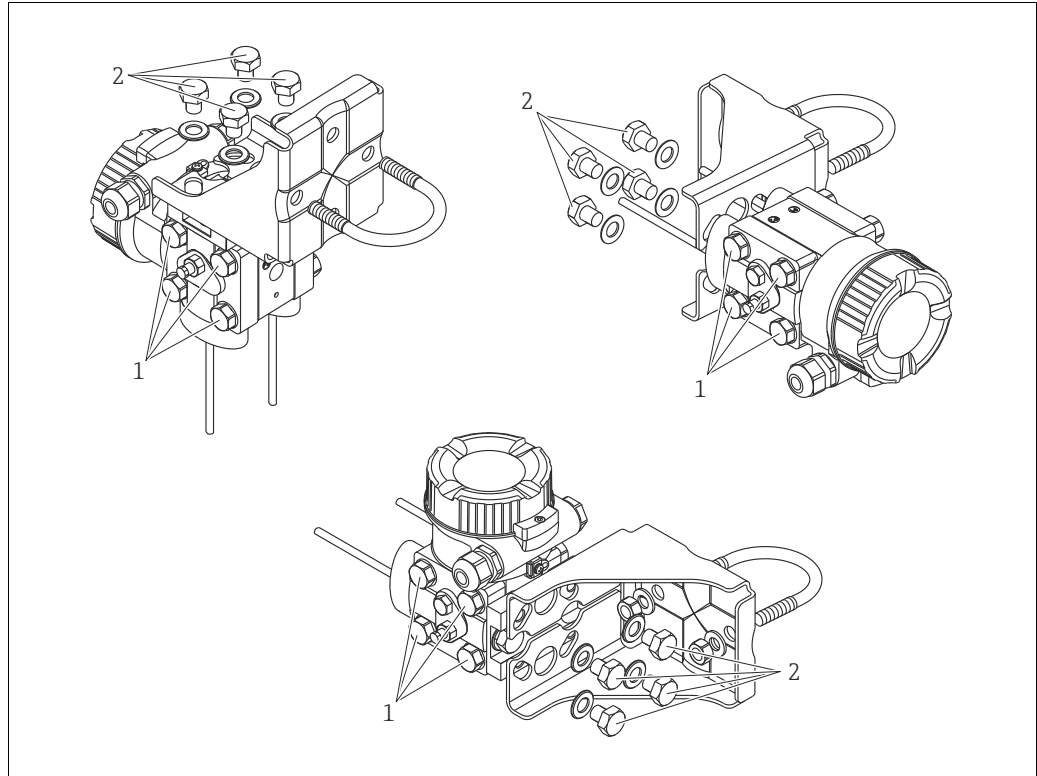

A0024167.eps

Typical installation arrangements



Abb. 16:

- A Impulse line vertical, version V1, alignment 90°
- B Impulse line horizontal, version H1, alignment 180°
- C Impulse line horizontal, version H2, alignment 90°
- 1 Deltabar M
- 2 Adapter plate
- 3 Mounting bracket
- 4 Pressure line

A0023109

4.7 Installing Deltapilot M

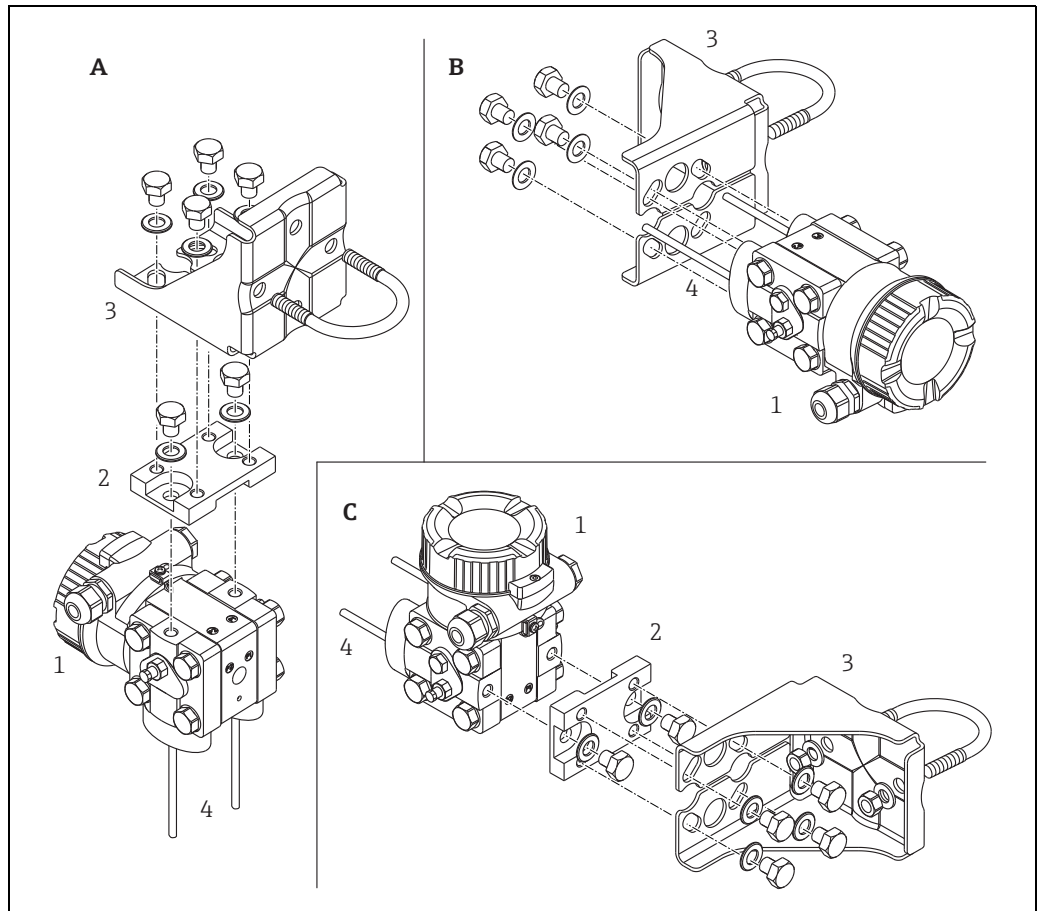
- Due to the orientation of the Deltapilot M, there may be a shift in the zero point, i.e. when the container is empty or partially full, the measured value does not display zero. You can correct this zero point shift → 47, Section "Function of the operating elements" or → 73, Section 8.3 "Pos. zero adjust".
- The local display can be rotated in 90° stages.
- Endress+Hauser offers a mounting bracket for installing on pipes or walls. → 21, Section 4.5.5 "Wall and pipe mounting (optional)".

4.7.1 General installation instructions

- Do not clean or touch process isolating diaphragms with hard or pointed objects.
- The process isolating diaphragm in the rod and cable version is protected against mechanical damage by a plastic cap.
- If a heated Deltapilot M is cooled during the cleaning process (e.g. by cold water), a vacuum develops for a short time, whereby moisture can penetrate the sensor through the pressure compensation (1). If this is the case, mount the Deltapilot M with the pressure compensation (1) pointing downwards.

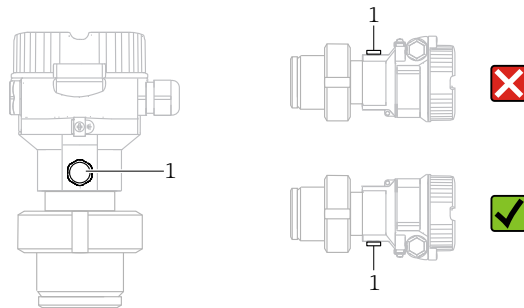

- Keep the pressure compensation and GORE-TEX® filter (1) free from contamination.
- The device must be installed as follows in order to comply with the cleanability requirements of the ASME-BPE (Part SD Cleanability):

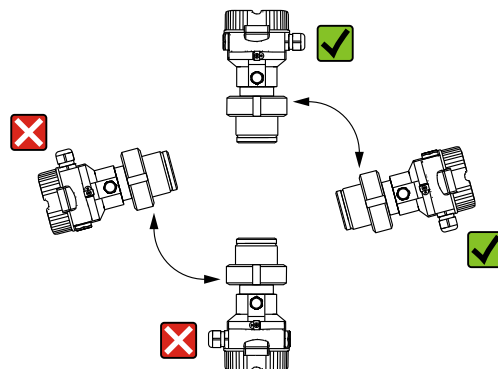

4.7.2 FMB50

Level measurement

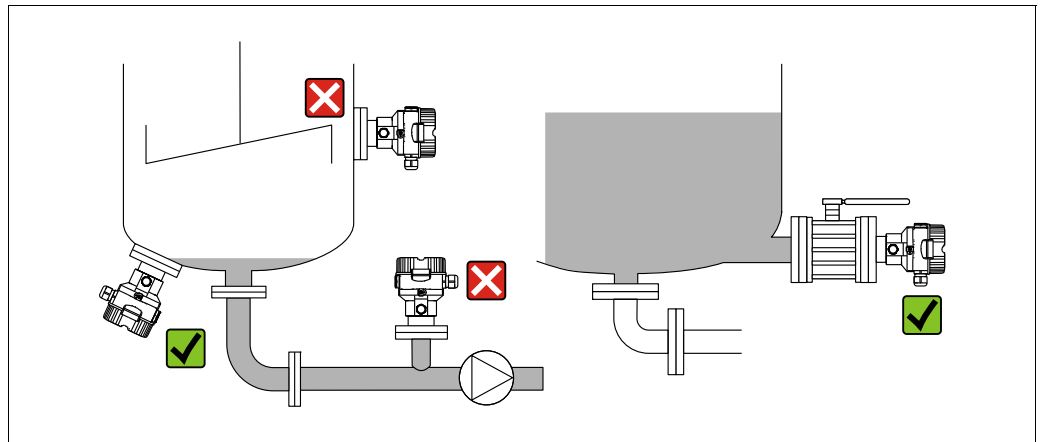

Fig. 17: Measuring arrangement for level

- Always install the device below the lowest measuring point.
- Do not install the device at the following positions:
 - in the filling curtain
 - in the tank outflow
 - in the suction area of a pump
 - or at a point in the tank that can be affected by pressure pulses from the agitator
- The calibration and functional test can be carried out more easily if you mount the device downstream of a shutoff device.
- Deltapilot M must be included in the insulation for media that can harden when cold.

Pressure measurement in gases

- Mount Deltapilot M with shutoff device above the tapping point so that any condensate can flow into the process.

Pressure measurement in steams

- Mount Deltapilot M with siphon above the tapping point.
- Fill the siphon with liquid before commissioning.
The siphon reduces the temperature to almost the ambient temperature.

Pressure measurement in liquids

- Mount Deltapilot M with the shutoff device below or at the same level as the tapping point.

4.7.3 FMB51/FMB52/FMB53

- When mounting rod and cable versions, make sure that the probe head is located at a point as free as possible from flow. To protect the probe from impact resulting from lateral movement, mount the probe in a guide tube (preferably made of plastic) or secure it with a clamping fixture.
- In the case of devices for hazardous areas, comply strictly with the safety instructions when the housing cover is open.
- The length of the extension cable or the probe rod is based on the planned level zero point. The height of the protective cap must be taken into consideration when designing the layout of the measuring point. The level zero point (E) corresponds to the position of the process isolating diaphragm. Level zero point = E; top of the probe = L.

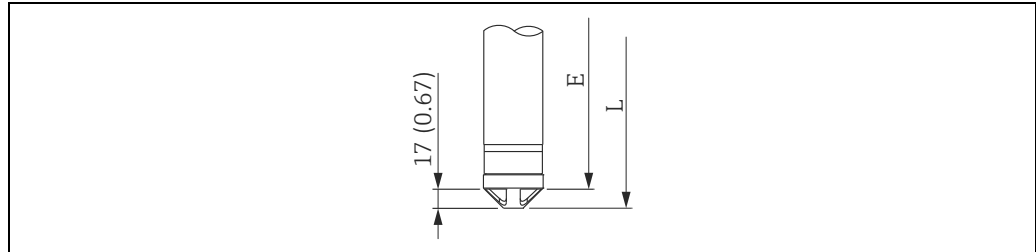

4.7.4 Mounting the FMB53 with a suspension clamp

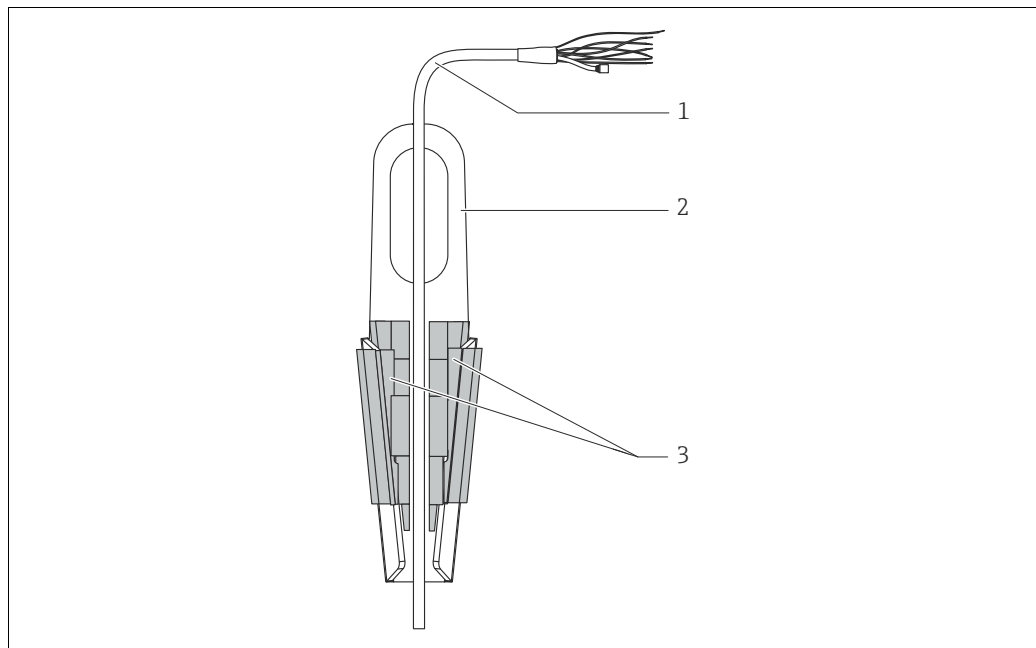

Fig. 18: Mounting with a suspension clamp

- | | |
|---|------------------|
| 1 | Extension cable |
| 2 | Suspension clamp |
| 3 | Clamping jaws |

Mounting the suspension clamp:

1. Mount the suspension clamp (item 2). When selecting the place to fix the unit, take the weight of the extension cable (item 1) and the device into account.
2. Raise the clamping jaws (item 3). Position the extension cable (item 1) between the clamping jaws as illustrated in Figure.
3. Hold the extension cable in position (item 1) and push the clamping jaws (item 3) back down.
Tap the clamping jaws gently from above to fix them in place.

4.7.5 Seal for flange mounting

NOTICE

Distorted measurement results.

The seal is not allowed to press on the process isolating diaphragm as this could affect the measurement result.

- Ensure that the seal is not touching the process isolating diaphragm.

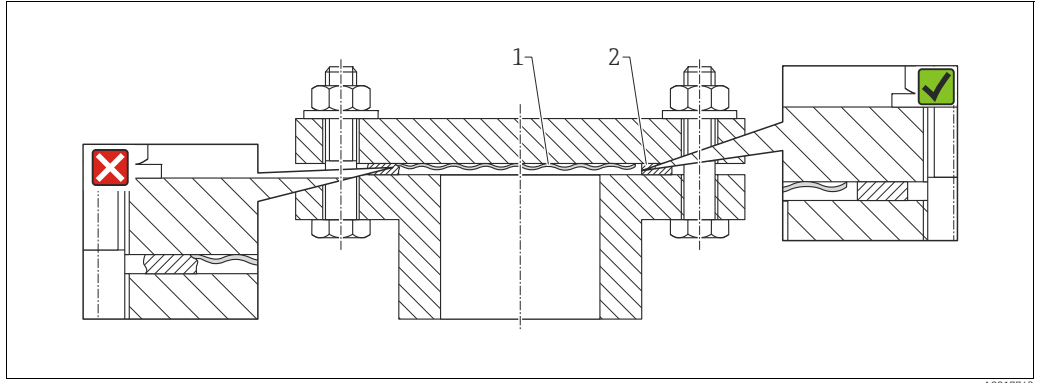
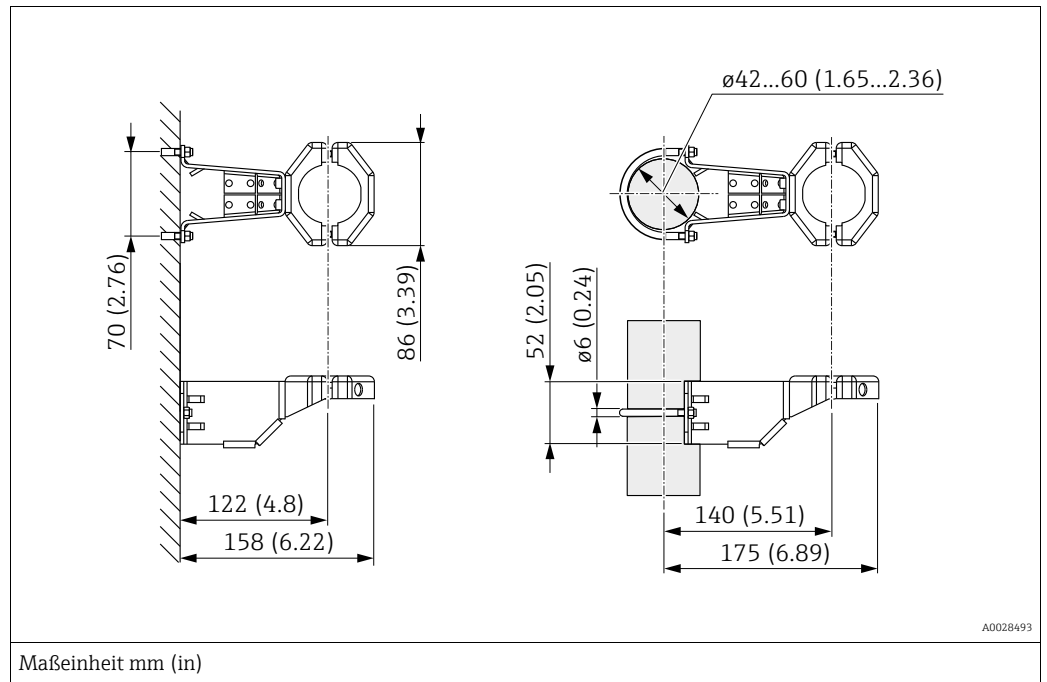

Fig. 19:
 1 Process isolating diaphragm
 2 Seal

4.7.6 Wall and pipe mounting (optional)

Mounting bracket

Endress+Hauser offers a mounting bracket for installing on pipes or walls (for pipes from 1 1/4" up to 2" diameter).



In the case of pipe mounting, the nuts on the bracket must be tightened uniformly with a torque of at least 5 Nm (3.69 lbf ft).

4.7.7 Assembling and mounting the "separate housing" version

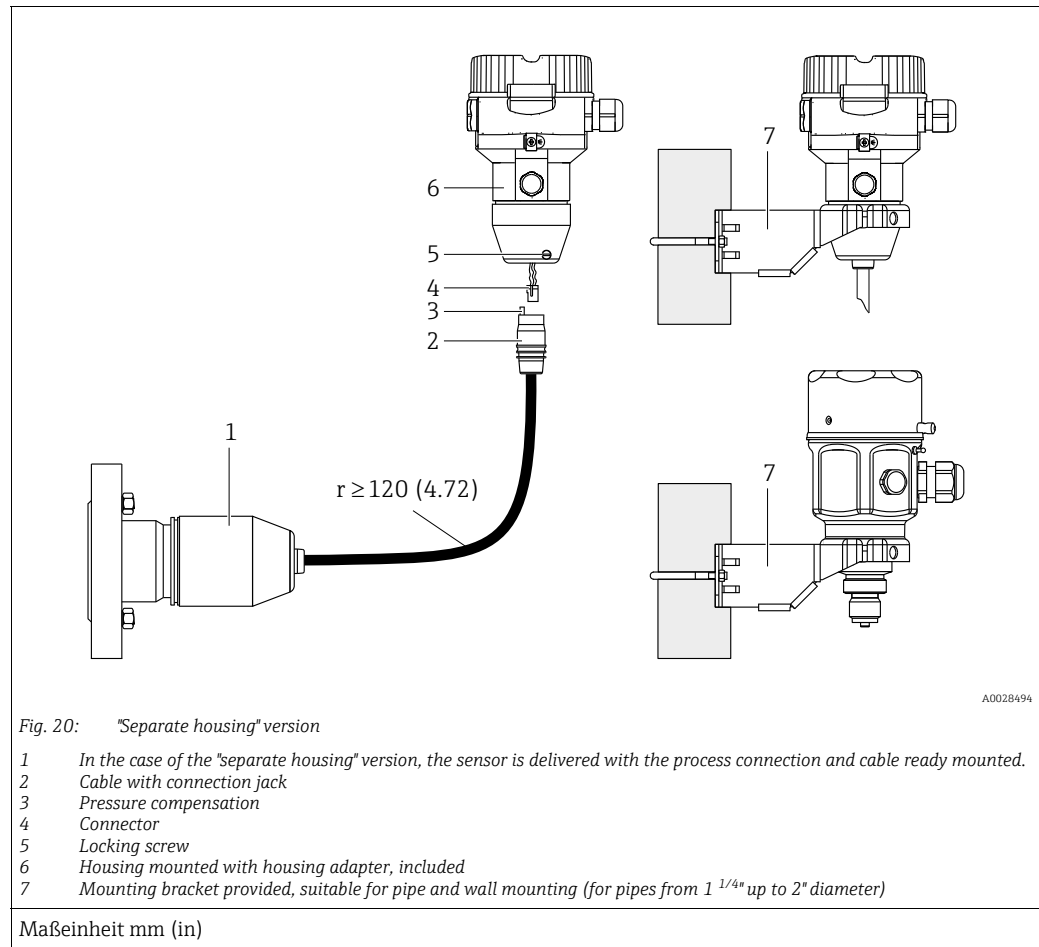

Assembly and mounting

1. Insert the connector (item 4) into the corresponding connection jack of the cable (item 2).
2. Plug the cable into the housing adapter (item 6).
3. Tighten the locking screw (item 5).
4. Mount the housing on a wall or pipe using the mounting bracket (item 7).
 When mounting on a pipe, tighten the nuts on the bracket uniformly with a torque of at least 5 Nm (3.69 lbf ft).
 Mount the cable with a bending radius (r) \geq 120 mm (4.72 in).

Routing the cable (e.g. through a pipe)

You require the cable shortening kit.

Order number: 71093286

For details on mounting, see SD00553P/00/A6.

4.7.8 Supplementary installation instructions

Sealing the probe housing

- Moisture must not penetrate the housing when mounting the device, establishing the electrical connection and during operation.
- Always firmly tighten the housing cover and the cable entries.

4.8 Installing profile seal for universal process adapter

For mounting details, see KA00096F/00/A3.

4.9 Closing the housing cover

NOTICE

Devices with EPDM cover seal - transmitter leakiness!

Mineral-based, animal-based or vegetable-based lubricants cause the EPDM cover seal to swell and the transmitter to become leaky.

- ▶ The thread is coated at the factory and therefore does not require any lubrication.

NOTICE

The housing cover can no longer be closed.

Damaged thread!

- ▶ When closing the housing cover, please ensure that the thread of the cover and housing are free from dirt, e.g. sand. If you feel any resistance when closing the cover, check the thread on both again to ensure that they are free from dirt.

4.9.1 Closing the cover on the stainless steel housing

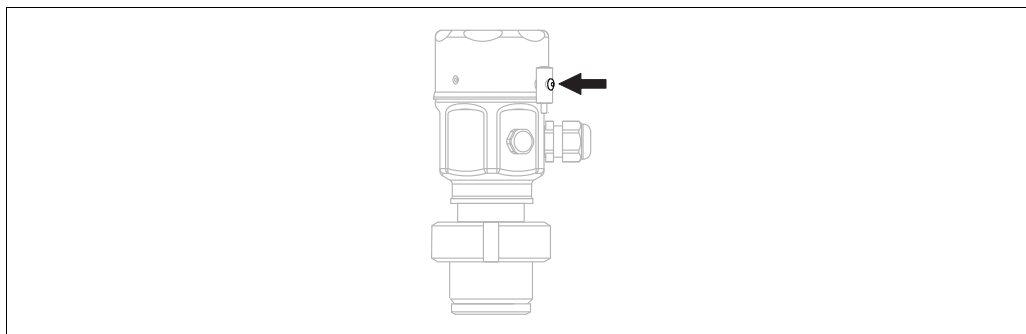

Fig. 21: Closing the cover

The cover for the electronics compartment is tightened by hand at the housing until the stop. The screw serves as DustEx protection (only available for devices with DustEx approval).

4.10 Post-installation check

0	Is the device undamaged (visual inspection)?
0	Does the device comply with the measuring point specifications? For example: <ul style="list-style-type: none"> ▪ Process temperature ▪ Process pressure ▪ Ambient temperature range ▪ Measuring range
0	Are the measuring point identification and labeling correct (visual inspection)?
0	Is the device adequately protected against precipitation and direct sunlight?
0	Are the securing screw and securing clamp tightened securely?

5 Electrical connection

5.1 Connecting the device

⚠ WARNING

Supply voltage might be connected!

Risk of electric shock and/or explosion!

- ▶ Ensure that no uncontrolled processes are activated in the system.
- ▶ Switch off the supply voltage before connecting the device.
- ▶ When using the measuring device in hazardous areas, installation must comply with the corresponding national standards and regulations and the Safety Instructions or Installation or Control Drawings.
- ▶ A suitable circuit breaker must be provided for the device in accordance with IEC/EN61010.
- ▶ Devices with integrated overvoltage protection must be grounded.
- ▶ Protective circuits against reverse polarity, HF influences and overvoltage peaks are integrated.

Connect the device in the following order:

1. Check that the supply voltage corresponds to the supply voltage indicated on the nameplate.
2. Switch off the supply voltage before connecting the device.
3. Remove housing cover.
4. Guide the cable through the gland. Preferably use a twisted, shielded two-wire cable.
5. Connect the device in accordance with the following diagram.
6. Screw down the housing cover.
7. Switch on the supply voltage.

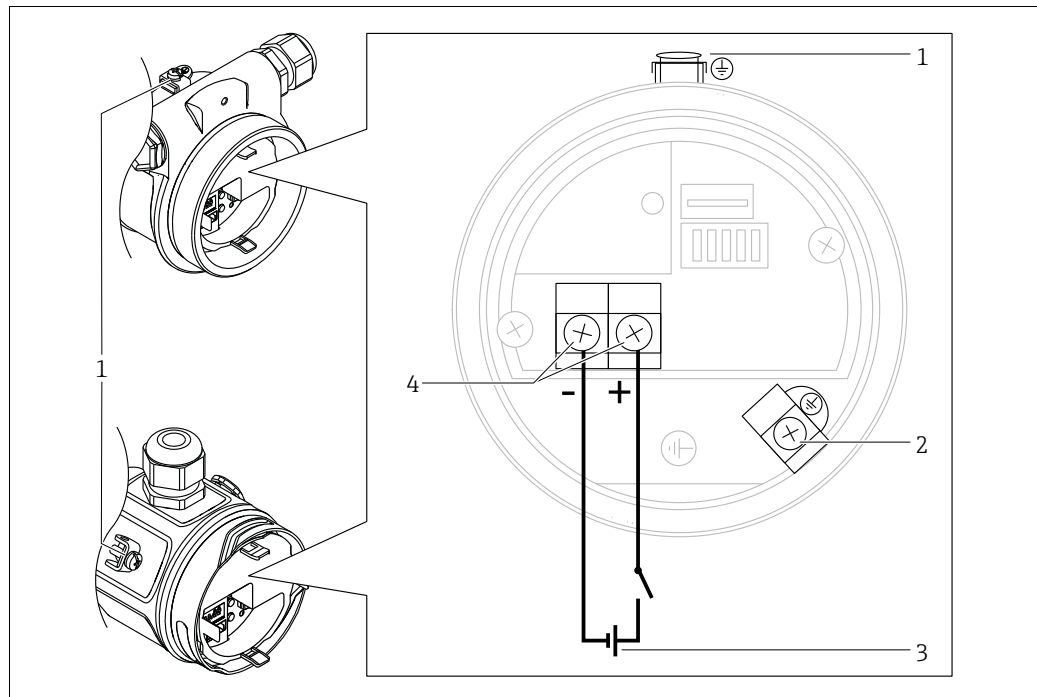

A0029967

FOUNDATION Fieldbus electrical connection

- 1 Terminals for supply voltage and signal
- 2 Grounding terminal
- 3 Supply voltage: 9 to 32 VDC (Power conditioner)
- 4 External ground terminal

5.1.1 Devices with 7/8" plug

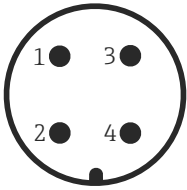
PIN assignment for 7/8" connector	PIN	Meaning
	1	Signal -
	2	Signal +
	3	Not assigned
	4	Shield

5.2 Connecting the measuring unit

5.2.1 Supply voltage

Electronic version	
FOUNDATION Fieldbus, version for non-hazardous areas	9 to 32 V DC

For further information on the network structure and grounding and for further bus system components such as bus cables, see the relevant documentation, e.g. Operating Instructions BA00013S "FOUNDATION Fieldbus Overview" and the FOUNDATION Fieldbus Guideline.

5.2.2 Current consumption

16 mA ± 1 mA, switch-on current corresponds to IEC 61158-2, Clause 21.

5.2.3 Terminals

- Supply voltage and internal ground terminal: 0.5 to 2.5 mm² (20 to 14 AWG)
- External ground terminal: 0.5 to 4 mm² (20 to 12 AWG)

5.2.4 Cable specification

- Endress+Hauser recommends using twisted, shielded two-wire cables.
- Cable outer diameter: 5 to 9 mm (0.2 to 0.35 in)



For further information on the cable specifications, see Operating Instructions BA00013S "FOUNDATION Fieldbus Overview", FOUNDATION Fieldbus Guideline and IEC 61158-2 (MBP).

5.2.5 Shielding/potential equalization

- You achieve optimum shielding against disturbances if the shielding is connected on both sides (in the cabinet and on the device). If potential equalization currents are expected in the plant, only ground shielding on one side, preferably at the transmitter.
- When using in hazardous areas, you must observe the applicable regulations. Separate Ex documentation with additional technical data and instructions is included with all Ex systems as standard.

5.3 Potential equalization

Hazardous area applications: Connect all devices to the local potential equalization. Observe the applicable regulations.

5.4 Overvoltage protection (optional)

Devices showing version "NA" in feature 610 "Mounted accessories" in the order code are equipped with a surge arrester (see Technical Information "Ordering information" section). The surge arrester is mounted at the factory on the housing thread for the cable gland and is approx. 70 mm (2.76 in) in length (take additional length into account when installing). The device is connected as specified in the following graphic. For details refer to TI001013KEN, XA01003KA3 and BA00304KA2.

5.4.1 Wiring

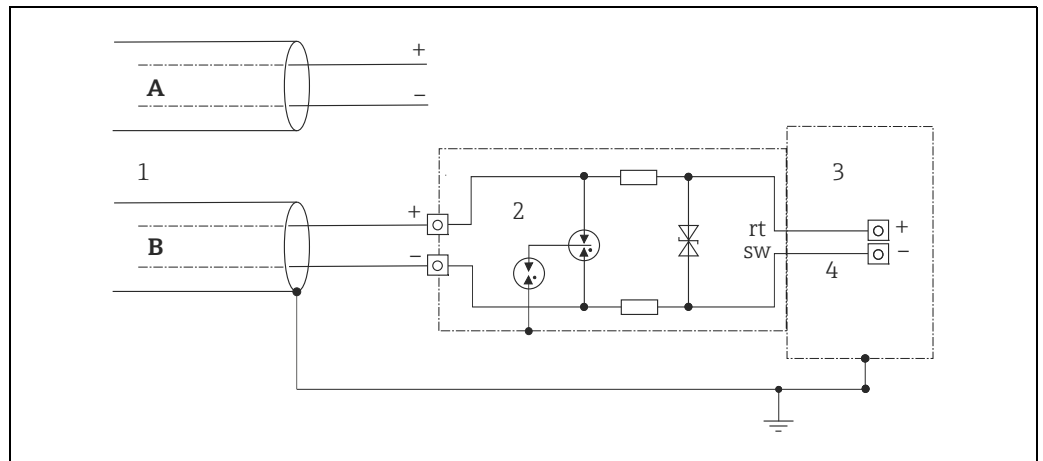
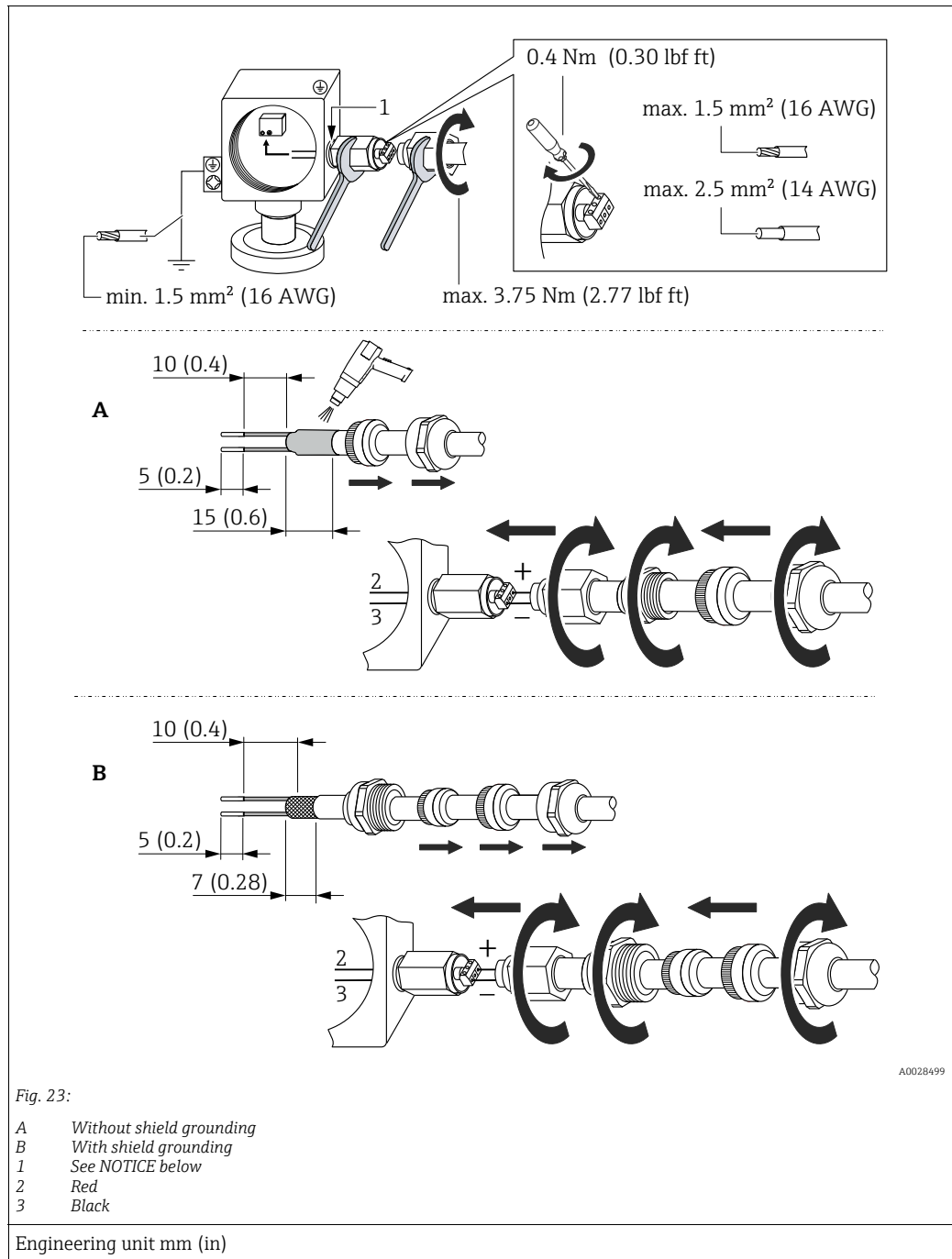

Fig. 22:

- A Without direct shield grounding
- B With direct shield grounding
- 1 Incoming connection cable
- 2 HAW569-DA2B
- 3 Unit to be protected
- 4 Connection cable

5.4.2 Installation



NOTICE

Screw connection glued at factory!

Damage to the device and/or surge arrester!

- ▶ When releasing/tightening the union nut use a wrench to hold the screw steady so it does not turn.

5.5 Post-connection check

Perform the following checks after completing electrical installation of the device:

- Does the supply voltage match the specifications on the nameplate?
- Is the device properly connected?
- Are all screws firmly tightened?
- Are the housing covers screwed down tight?

As soon as voltage is applied to the device, the green LED on the electronic insert lights up briefly or the connected onsite display lights up.

6 Operation

6.1 Operating options

6.1.1 Operation without operating menu

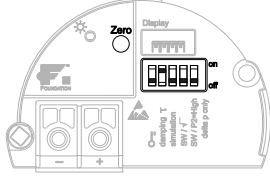

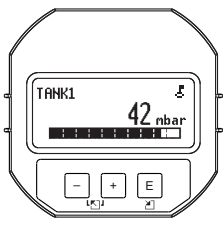
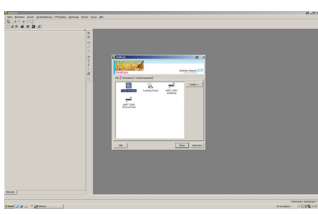

Operating options	Explanation	Graphic illustration	Description
Local operation without device display	The device is operated using the operating key and DIP switches on the electronic insert.		→ 46

6.1.2 Operation with an operating menu

Operation with an operating menu is based on an operation concept with "user roles"
→ 48.

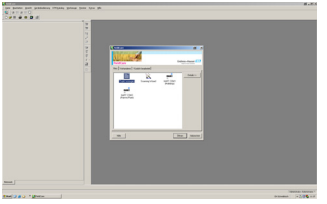
Operating options	Explanation	Graphic illustration	Description
Local operation with device display	The device is operated using the operating keys on the device display.		→ 49
Remote operation via FieldCare	The device is operated using the FieldCare operating tool.		→ 53

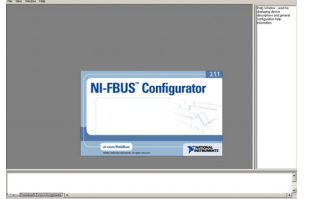
6.1.3 Operation via FF communication protocol

Operating options	Explanation	Graphic illustration	Description
Remote operation via FieldCare	The device is operated using the FieldCare operating tool.		→  57
Remote operation via the NI Tool	The device is operated using the NI Tool.		→  138

6.2 Operation without an operating menu

6.2.1 Position of operating elements

The operating key and DIP switches are located on the electronic insert in the device.

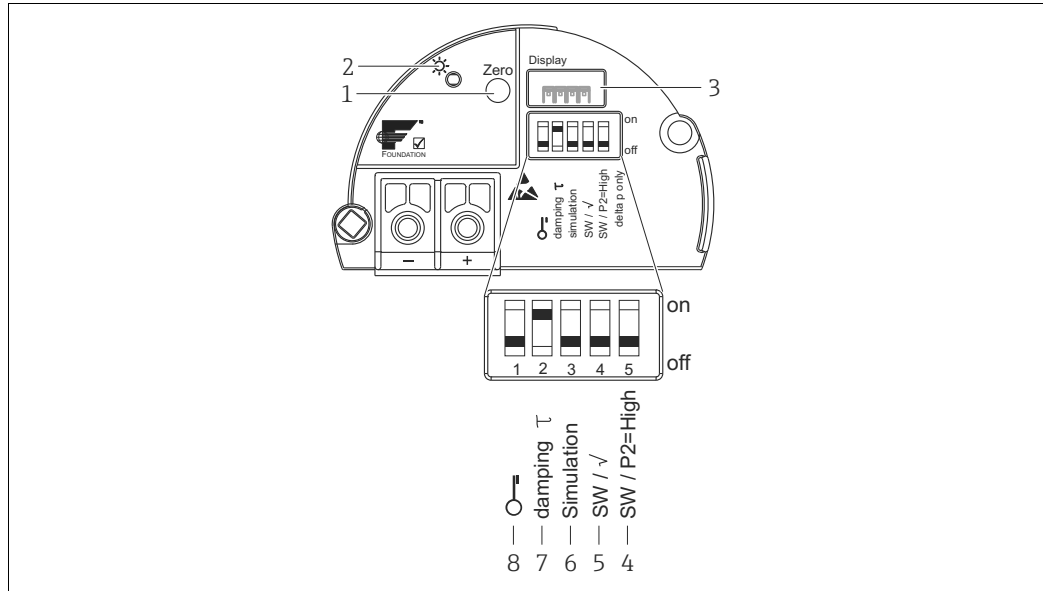

Fig. 24: FOUNDATION Fieldbus electronic insert

- 1 Operating key for position zero adjustment (Zero) or reset
- 2 Green LED to indicate successful operation
- 3 Slot for optional local display
- 4+5 DIP switch only for Deltabar M
 - Switch 5: "SW/Square root"; used to control the output characteristics
 - Switch 4: "SW/P2-High"; used to determine the high-pressure side
- 6 DIP-switch for simulation mode
- 7 DIP switch for switching damping on/off
- 8 DIP switch for locking/unlocking parameters relevant to the measured value

Function of the DIP switches

Switches	Symbol/labeling	Switch position	
		"off"	"on"
1		The device is unlocked. Parameters relevant to the measured value can be modified.	The device is locked. Parameters relevant to the measured value cannot be modified.
2	damping τ	Damping is switched off. The output signal follows measured value changes without any delay.	Damping is switched on. The output signal follows measured value changes with the delay time τ . ¹⁾
3	Simulation	The simulation mode is switched off (factory setting).	The simulation mode is switched on.
The following switches only for Deltabar M:			
4	SW/ $\sqrt{\quad}$	The output characteristics is defined by the setting in the operating menu. <ul style="list-style-type: none"> ■ "Setup" -> "Measuring mode" ■ "Setup" -> "Extended setup" -> 	The measuring mode is "flow" and the output characteristics is "Square root" regardless of the settings in the operating menu.
5	SW/P2= High	The high-pressure (+/HP) side is defined by the setting in the operating menu. ("Setup" -> "High Press. Side")	The high-pressure side (+/HP) is allocated to the P2 pressure connection regardless of the setting in the operating menu.

1) The value for the delay time can be configured via the operating menu ("Setup" -> "Damping").
Factory setting: $\tau = 2$ s or as per order specifications.

Function of the operating elements

Operating key	Meaning
"Zero" pressed for at least 3 seconds	Position adjustment (zero point correction) Press key for at least 3 seconds. The LED on the electronic insert lights up briefly if the pressure applied has been accepted for position adjustment. → See also the following Section "Performing position adjustment on site."
"Zero" pressed for at least 12 seconds	Reset All parameters are reset to the order configuration.

Performing position adjustment on site

- Operation must be unlocked. →  54, Section 6.3.5 "Locking/unlocking operation".
- The device is configured at the factory for the Pressure measuring mode (Cerabar, Deltabar) or Level measuring mode (Deltapilot).
 - Operation via FF configuration program: In the Pressure Transducer Block, you can change the measuring mode by means of the PRIMARY_VALUE_TYPE parameter.
- The pressure applied must be within the nominal pressure limits of the sensor. See information on the nameplate.
- To reconcile the parameter database, perform a "Reconcile device" (after position adjustment) with the FF host.

Perform position adjustment:

1. Pressure is present at device.
2. Press key for at least 3 seconds.
3. If the LED on the electronic insert lights up briefly, the pressure applied has been accepted for position adjustment.
If the LED does not light up, the pressure applied was not accepted. Observe the input limits. For error messages, →  221, Section 11.1 "Messages".

6.2.2 Locking/unlocking operation

Once you have entered all the parameters, you can lock your entries against unauthorized and undesired access.



If operation is locked by means of the DIP switch, you can only unlock operation again by means of the DIP switch. If operation is locked by means of the operating menu, you can only unlock operation again using the operating menu.

Locking/unlocking via DIP switches

DIP switch 1 on the electronic insert is used to lock/unlock operation.
→  46, "Function of the DIP switches".

6.3 Operation with an operating menu

6.3.1 Operation concept

The operation concept makes a distinction between the following user roles:

User role	Meaning
Operator	Operators are responsible for the devices during normal "operation". This is usually limited to reading process values either directly at the device or in a control room. If the work with the devices extends beyond value read-off tasks, the tasks involve simple, application-specific functions that are used in operation. Should an error occur, these users simply forward the information on the errors but do not intervene themselves.
Service engineer/ technician	Service engineers usually work with the devices in the phases following device commissioning. They are primarily involved in maintenance and troubleshooting activities for which simple settings have to be made at the device. Technicians work with the devices over the entire life cycle of the product. Thus, commissioning and advanced settings and configurations are some of the tasks they have to carry out.
Expert	Experts work with the devices over the entire product life cycle, but their device requirements are often extremely high. Individual parameters/functions from the overall functionality of the devices are required for this purpose time and again. In addition to technical, process-oriented tasks, experts can also perform administrative tasks (e.g. user administration). "Experts" can avail of the entire parameter set.

6.3.2 Structure of the operating menu

User role	Submenu	Meaning/use
Operator	Language	Only consists of the "Language" parameter (000) where the operating language for the device is specified. The language can always be changed even if the device is locked.
Operator	Display/operat.	Contains parameters that are needed to configure the measured value display (selecting the values displayed, display format, display contrast, etc.). With this submenu, users can change the measured value display without affecting the actual measurement.
Service engineer/ technician	Setup	Contains all the parameters that are needed to commission measuring operations. This submenu has the following structure: <ul style="list-style-type: none"> ▪ Standard setup parameters A wide range of parameters, which can be used to configure a typical application, is available at the start. The measuring mode selected determines which parameters are available. After making settings for all these parameters, the measuring operation should be completely configured in the majority of cases. ▪ "Extended setup" submenu The "Extended setup" submenu contains additional parameters for more in-depth configuration of the measurement operation to convert the measured value and to scale the output signal. This menu is split into additional submenus depending on the measuring mode selected.

User role	Submenu	Meaning/use
Service engineer/ technician	Diagnosis	<p>Contains all the parameters that are needed to detect and analyze operating errors. This submenu has the following structure:</p> <ul style="list-style-type: none"> ▪ Diagnostic list Contains up to 10 error messages currently pending. ▪ Event logbook Contains the last 10 error messages (no longer pending). ▪ Instrument info Contains information on the device identification. ▪ Measured values Contains all the current measured values ▪ Simulation Is used to simulate pressure, level, flow and alarm/warning. ▪ Reset
Expert	Expert	<p>Contains all the parameters of the device (including those in one of the submenus). The "Expert" submenu is structured by the function blocks of the device. It thus contains the following submenus:</p> <ul style="list-style-type: none"> ▪ System Contains general device parameters that neither affect measurement nor integration into a distributed control system. ▪ Measurement Contains all the parameters for configuring the measurement. ▪ Communication Contains all the parameters of the FOUNDATION Fieldbus interface. ▪ Application Contains all the parameters for configuring the functions that go beyond the actual measurement (e.g. totalizer). ▪ Diagnosis Contains all the parameters that are needed to detect and analyze operating errors.



For an overview of the entire operating menu: → 108 ff.

Direct access to parameters

The parameters can only be accessed directly via the "Expert" user role.

Parameter name	Description
<p>Direct access (119) Entry</p> <p>Menu path: Expert → Direct access</p>	<p>Use this function to enter a parameter code for direct access.</p> <p>User input:</p> <ul style="list-style-type: none"> ▪ Enter the desired parameter code. <p>Factory setting: 0</p>

6.3.3 Operation with a device display (optional)

A 4-line liquid crystal display (LCD) is used for display and operation. The onsite display shows measured values, dialog texts, fault messages and notice messages. For easy operation the display can be taken out of the housing (see figure steps 1 to 3). It is connected to the device through a 90 mm (3.54 in) cable. The display of the device can be turned in 90° stages (see figure steps 4 to 6). Depending on the orientation of the device, this makes it easy to operate the device and read the measured values.

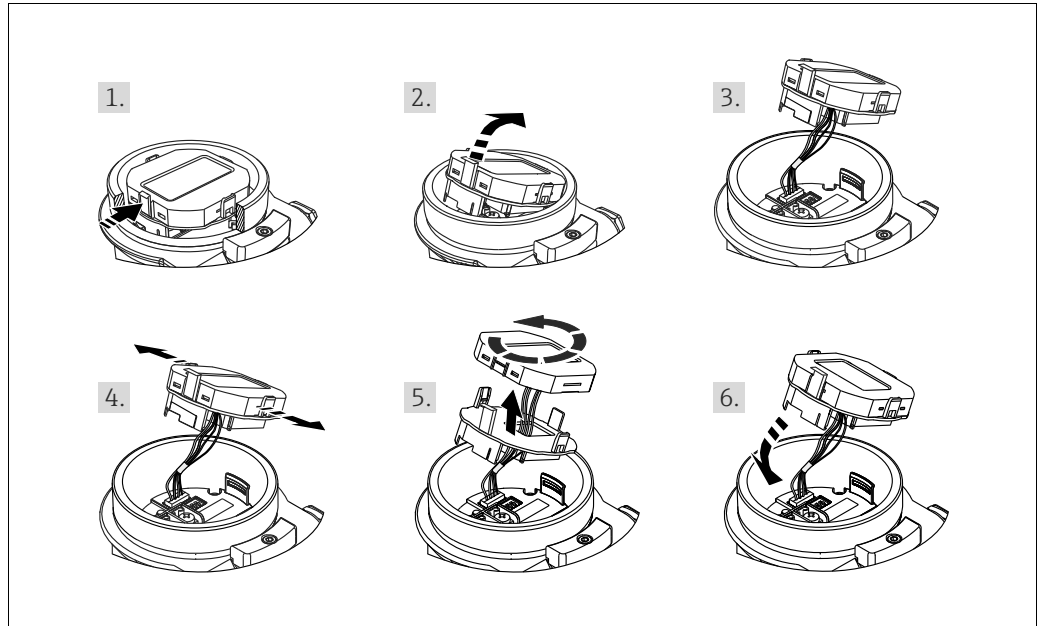

A0028500

Functions:

- 8-digit measured value display including sign and decimal point.
- Bar graph as graphic display of the current pressure measured value in relation to the set pressure range in the Pressure Transducer Block. The pressure range is set by means of the SCALE_IN parameter (via FF configuration program, not via onsite display).
- Three keys for operation.
- Simple and complete menu guidance as parameters are split into several levels and groups.
- Each parameter is given a 3-digit parameter code for easy navigation.
- Possibility of configuring the display to suit individual requirements and preferences, such as language, alternating display, display of other measured values such as sensor temperature, contrast setting.
- Comprehensive diagnostic functions (fault and warning message etc.).

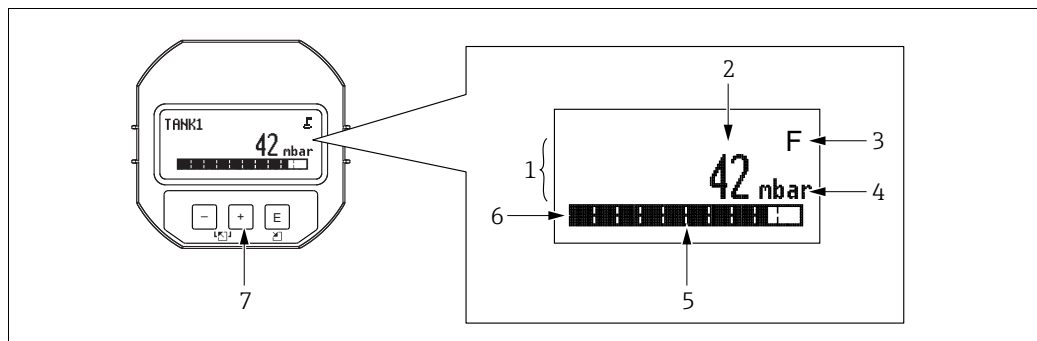









A0030013



Fig. 25: Display

- 1 Main line
- 2 Value
- 3 Symbol
- 4 Unit
- 5 Bar graph
- 6 Information line
- 7 Operating keys

The following table illustrates the symbols that can appear on the onsite display. Four symbols can occur at one time.

Symbol	Meaning
	Lock symbol The operation of the device is locked. To unlock the device, → 54 , Locking/unlocking operation.
	Communication symbol Data transfer via communication
	Square root symbol (only Deltabar M) Active measuring mode "Flow measurement"
	Error message "Out of specification" The device is being operated outside its technical specifications (e.g. during warmup or cleaning processes).
	Error message "Service mode" The device is in the service mode (during a simulation, for example).
	Error message "Maintenance required" Maintenance is required. The measured value remains valid.
	Error message "Failure detected" An operating error has occurred. The measured value is no longer valid.
	Simulation symbol Simulation mode is activated. DIP switch 2 for simulation is set to "On". → See also Section 6.2.1 "Position of operating elements" and → 54 , Section 6.3.6 "Simulation".

Operating keys on the display and operating module

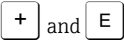
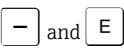
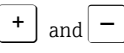
Operating key(s)	Meaning
	<ul style="list-style-type: none"> - Navigate downwards in the picklist - Edit the numerical values and characters within a function
	<ul style="list-style-type: none"> - Navigate upwards in the picklist - Edit the numerical values and characters within a function
	<ul style="list-style-type: none"> - Confirm entry - Jump to the next item - Selection of a menu item and activation of the editing mode
	Contrast setting of onsite display: darker
	Contrast setting of onsite display: brighter
	ESC functions: <ul style="list-style-type: none"> - Exit the edit mode for a parameter without saving the changed value. - You are in a menu at a selection level. Each time you press the keys simultaneously, you go up a level in the menu.

Operating example: Parameters with a picklist

Example: selecting "Deutsch" as the language of the menu.

	Language	000	Operation
1	✓ English Deutsch		"English" is set as the menu language (default value). A ✓ in front of the menu text indicates the active option.
2	Deutsch ✓ English		Select "Deutsch" with $\left[\uparrow \right]$ or $\left[\downarrow \right]$.
3	✓ Deutsch English		<ol style="list-style-type: none"> Confirm your choice with $\left[\text{Enter} \right]$. A ✓ in front of the menu text indicates the active option ("Deutsch" is now selected as the menu language). Exit the edit mode for the parameter with $\left[\text{Enter} \right]$.

Operating example: User-definable parameters

Example: setting "Set URV" parameter from 100 mbar (1.5 psi) to 50 mbar (0.75 psi).

	Set URV	014	Operation
1	1 0 0 . 0 0 0 mbar		The local display shows the parameter to be changed. The value highlighted in black can be changed. The "mbar" unit is specified in another parameter and cannot be modified here.
2	1 0 0 . 0 0 0 mbar		<ol style="list-style-type: none"> Press $\left[\uparrow \right]$ or $\left[\downarrow \right]$ to get to the editing mode. The first digit is highlighted in black.
3	5 0 0 . 0 0 0 mbar		<ol style="list-style-type: none"> Use $\left[\uparrow \right]$ to change "1" to "5". Confirm "5" with $\left[\text{Enter} \right]$. The cursor jumps to the next position (highlighted in black). Confirm "0" with $\left[\text{Enter} \right]$ (second position).
4	5 0 0 . 0 0 0 mbar		The third position is highlighted in black and can now be edited.
5	5 0 \blacktriangledown . 0 0 0 mbar		<ol style="list-style-type: none"> Switch to the "↓" symbol with the $\left[\downarrow \right]$ key. Use $\left[\text{Enter} \right]$ to save the new value and exit the editing mode. → See next graphic.
6	5 0 . 0 0 0 mbar		<p>The new value for the upper range value is 50.0 mbar (0.75 psi).</p> <ul style="list-style-type: none"> - You exit the edit mode for the parameter with $\left[\text{Enter} \right]$. - You can get back to the editing mode with $\left[\uparrow \right]$ or $\left[\downarrow \right]$.

Operating example: Accepting the pressure present



Example: setting position adjustment

	Pos. zero adjust	007	Operation
1	✓ Abort		The pressure for position adjustment is present at the device.
	Confirm		
2	Confirm		Use <input type="checkbox"/> or <input type="checkbox"/> to switch to the "Confirm" option. The active option is highlighted in black.
	✓ Abort		
3	Compensation accepted!		Accept the pressure present as position adjustment with the <input type="checkbox"/> key. The device confirms the adjustment and goes back to the "Pos. zero adjust" parameter.
4	✓ Abort		Exit the edit mode for the parameter with <input type="checkbox"/> .
	Confirm		

6.3.4 Operation via FieldCare

FieldCare is an Endress+Hauser asset management tool based on FDT technology. With FieldCare, you can configure all Endress+Hauser devices as well as devices from other manufacturers that support the FDT standard. Hard- and software requirements can be found on the Internet: www.endress.com → Search for: FieldCare → FieldCare → Technical data.

FieldCare supports the following functions:

- Configuration of transmitters in online/offline mode
- Loading and saving device data (upload/download): see parameter "Download select" →  119 in operating menu or via Resource block →  173.
- Documentation of the measuring point
- Offline parametrization of transmitters



- In "Level expert" measuring mode, the configuration data which were generated by FDT upload cannot be saved back again (FDT download); they are used solely to document the configuration.
- Further information on FieldCare can be found on the Internet (<http://www.endress.com>, Download → Search for: FieldCare).
- As not all internal device dependencies can be mapped in offline operation, the consistency of the parameters must be checked before the parameters are transmitted to the device.
- All the function blocks are set to the OOS mode following a download. The DIP switches must be set to the as-delivered state for this purpose (see Figure →  46).

6.3.5 Locking/unlocking operation

Once you have entered all the parameters, you can lock your entries against unauthorized and undesired access.

Locked operation is indicated as follows:

- By the  symbol on the onsite display
- The parameters are grayed out in FieldCare and the handheld terminal, which means they cannot be edited. Indicated in the corresponding "Lockstate/STATUS_LOCKING" parameter.

Parameters which refer to how the display appears, e.g. "**Language (000)**", can still be altered.



If operation is locked by means of the DIP switch, you can only unlock operation again by means of the DIP switch. If operation is locked by means of the operating menu, you can only unlock operation again using the operating menu.

The "**Operator code (021)**" parameter is used to lock and unlock the device.

Parameter name	Description
Operator code (021) Entry Menu path: Setup → Extended setup → Operator code (021)	Use this function to enter a code to lock or unlock operation. User input: <ul style="list-style-type: none"> ▪ To lock: Enter a number ≠ the release code (value range: 1 to 9999). ▪ To unlock: Enter the release code.  The release code is "0" in the order configuration. Another release code can be defined in the " Code definition (023) " parameter. If the user has forgotten the release code, the release code can be visible by entering the number "5864". Factory setting: 0

The release code is defined in the "**Code definition (023)**" parameter.

Parameter name	Description
Code definition (023) Entry Menu path: Setup → Extended setup → Code definition (023)	Use this function to enter a release code with which the device can be unlocked. User input: <ul style="list-style-type: none"> ▪ A number between 0 and 9999 Factory setting: 0

6.3.6 Simulation

Simulate the output of the Analog Input Block as follows:

1. Set the "Simulation" DIP switch on the electronic insert to "On".
2. In the Analog Input Block, select the "Active" option by means of the "Simulate/SIMULATE" record parameter, "Simulate En/Disable/ENABLE_DISABLE" element.
3. Enter the value and status for the "Simulate value/SIMULATION_VALUE" and "Simulate status/SIMULATION_STATUS" elements. During the simulation, the output value and status of the Analog Input Block are replaced by the simulated value and status. The Output/OUT parameter shows the result.
4. End simulation (via "Simulate/SIMULATE" record parameter,

"Simulate En/Disable/ENABLE_DISABLE" element, "Disabled" option), set "Simulation" DIP switch to "OFF".



You can check your adjustment for the transmitter by means of the Simulation mode/SIMULATION_MODE and Simulated Value/SIMULATED_VALUE parameters in the Diagnostic Transducer Block. → See Simulation mode/SIMULATION_MODE and Simulated Value/SIMULATED_VALUE parameter description.

6.3.7 Resetting to factory settings (reset)

By entering a certain code, you can completely, or partially, reset the entries for the parameters to the factory settings¹⁾. Enter the code by means of the "Enter reset code (124)" parameter (menu path: "Diagnosis" → "Reset" → "Enter reset code (124)" or "Diagnosis" → "Reset" → "Enter reset code (124)").

There are various reset codes for the device. The following table illustrates which parameters are reset by the particular reset codes. Operation must be unlocked to reset parameters (→ 54).



Any customer-specific configuration carried out at the factory is not affected by a reset (customer-specific configuration remains). If you want to change the customer-specific configuration carried out at the factory, please contact Endress+Hauser Service.

Reset code ¹⁾	Description and effect
62	PowerUp reset (warm start) <ul style="list-style-type: none"> ▶ The device is restarted. ▶ Data are read back anew from the EEPROM (processor is initialized again). ▶ Any simulation which may be running is ended.
333	User reset <ul style="list-style-type: none"> ▶ This code resets all the parameters apart from: <ul style="list-style-type: none"> - Pd-tag. (022) - Linearization table - Operating hours (162) - Event logbook - Lo trim sensor (131) - Hi trim sensor (132) ▶ Any simulation which may be running is ended. ▶ The device is restarted.
7864	Total reset <ul style="list-style-type: none"> ▶ This code resets all the parameters apart from: <ul style="list-style-type: none"> - Operating hours (162) - Event logbook - Lo trim sensor (131) - Hi trim sensor (132) ▶ Any simulation which may be running is ended. ▶ The device is restarted.

1) To be entered in "Diagnosis" → "Reset" → "Enter reset code (124)"

1) The default value for the individual parameters is indicated in the parameter description (→ 116 ff)

6.4 FOUNDATION Fieldbus communication protocol

6.4.1 System architecture

The following diagram shows two typical examples of a FOUNDATION Fieldbus network with the associated components.

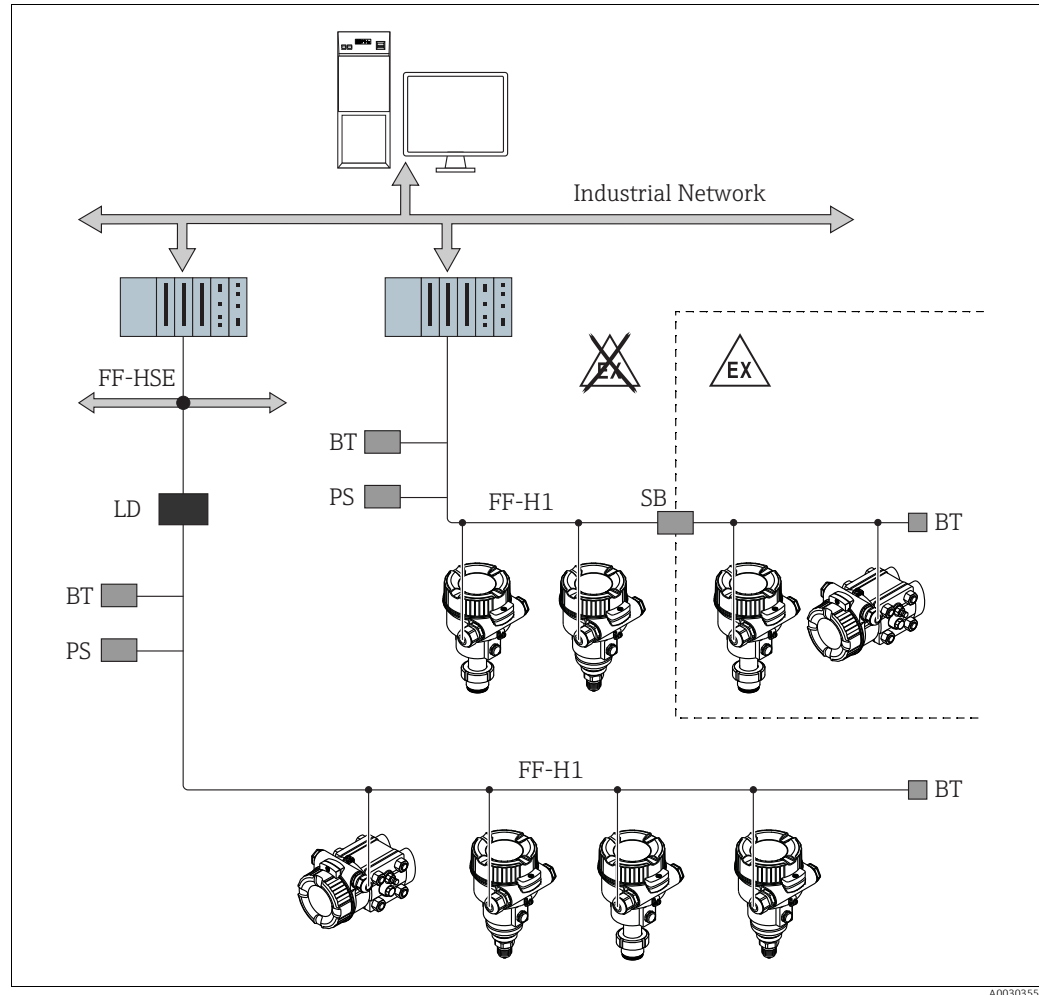

Fig. 26: FOUNDATION Fieldbus system architecture with associated components

FF-HSE High Speed Ethernet
 FF-H1 FOUNDATION Fieldbus-H1
 LD Linking Device FF-HSE/FF-H1
 PS Bus Power Supply
 SB Safety Barrier
 BT Bus Terminator

The system can be connected in the following ways:

- A linking device makes the connection to higher-order fieldbus levels (e.g. High Speed Ethernet (HSE)) possible.
- An FF-H1 connecting card is needed for direct connection to a process control system.



Further information on FOUNDATION Fieldbus can be found in Operating Instructions BA00013S "FOUNDATION Fieldbus Overview, Installation and Commissioning Guidelines", the FOUNDATION Fieldbus Specification or on the Internet at "<http://www.fieldbus.org>".

6.4.2 Number of devices

- Endress+Hauser devices meet the requirements specified by the FISCO model.
- Due to the low current consumption, the following can be operated at one bus segment when installation is performed according to FISCO:
 - Up to 6 devices for EEx ia, CSA and FM IS applications
 - Up to 22 devices in all other applications, e.g. in non hazardous areas, EEx nA etc.
 The maximum number of measuring devices at one bus segment is defined by their current consumption, the performance of the bus coupler, and the required bus length.

6.4.3 Operation

You can obtain special configuration and operating programs from various manufacturers for the configuration, such as the FieldCare operating program from Endress+Hauser → § 53, Section 6.3.4 "Operation via FieldCare". These configuration programs make it possible to configure FF functions and all the device-specific parameters. The predefined function blocks allow uniform access to network and device data.

6.4.4 Network configuration

You require the following to configure a device and integrate it into an FF network:

- An FF configuration program
- The Cff file (Common File Format: *.cff)
- The device description (DD)
 - (Device Description format 4 : *sym, *ffo or
 - Device Description format 5 : *sy5, *ff5)

Pre-defined standard DDs, which can be obtained from FOUNDATION Fieldbus, are available for the basic functions of measuring devices. You require the device-specific DD to be able to access all the functions.

The files for the devices can be acquired as follows:

- Internet Endress+Hauser: <http://www.endress.com> → Search for FOUNDATION Fieldbus
- Internet FOUNDATION Fieldbus: <http://www.fieldbus.org>

The device is integrated into the FF network as follows:

- Start the FF configuration program.
- Download the Cff and device description files (*.ffo, *.sym (for format 4) *ff5, *sy5 (for format 5) to the system.
- Configure the interface, see Note.
- Configure the device for the measuring task and for the FF system.



- For more in-depth information on integrating the device into the FF system, see the description for the configuration software used.
- When integrating the field devices into the FF system, make sure you are using the right files. You can read out the required version by means of the Device Revision/DEV_REV and DD Revision/DD_REV parameters in the Resource Block.

6.4.5 Device identification and addressing

FOUNDATION Fieldbus identifies the device using its ID code and automatically assigns it a suitable field address. The identity code cannot be changed.

The device appears in the network display once you have started the FF configuration program and integrated the device into the network. The blocks available are displayed under the device name.

If the device description has not yet been loaded, the blocks report "Unknown" or "(UNK)".

The devices report as follows (typical display in a configuration program after the connection has been established):

Device name	Serial number
☐ -	
☐ -	
☐ EH_ Deltabar M_5X	_ 00000000000000
☐RS_0000000000 (RB2)	
☐TRD1_0000000000 (PCD)	
☐DP_FLOW_0000000000 (DPFLOW)	
☐DIAGNOSTIC_0000000000 (DIAGNOSTIC)	
☐DISPLAY_0000000000 (DISP)	
☐AI1_0000000000 (AI)	
☐AI2_0000000000 (AI)	
☐DI_0000000000 (DI)	
☐DO_0000000000 (DO)	
☐ISEL_0000000000 (ISB)	
☐PID_0000000000 (PID)	
☐ARTH_0000000000 (ARB)	
☐CHAR_0000000000 (SCB)	
☐INTG_0000000000 (ITB)	
☐ EH_ Cerabar M_5X	_ 00000000000000
☐ EH_ Deltapilot M_5X	_ 00000000000000
☐RS_0000000000 (RB2)	
☐TRD1_0000000000 (PCD)	
☐DIAGNOSTIC_0000000000 (DIAGNOSTIC)	
☐DISPLAY_0000000000 (DISP)	
☐AI1_0000000000 (AI)	
☐AI2_0000000000 (AI)	
☐DI_0000000000 (DI)	
☐DO_0000000000 (DO)	
☐ISEL_0000000000 (ISB)	
☐PID_0000000000 (PID)	
☐ARTH_0000000000 (ARB)	
☐CHAR_0000000000 (SCB)	
☐INTG_0000000000 (ITB)	

6.4.6 Block model

With FOUNDATION Fieldbus, all the device parameters are categorized according to their functional properties and task and are generally assigned to three different blocks.

A FOUNDATION Fieldbus device has the following block types:

- A Resource Block (device block):
This block contains all the device-specific features of the device.
- One or more Transducer Blocks
A Transducer Block contains all the measuring and device-specific parameters of the device. The measuring principles, such as pressure or totalizers, are mapped in the Transducer Blocks.
- One or more function blocks:
Function blocks contain the automation functions of the device. A distinction is made between different function blocks such as the Analog Input Block or PID Block. Each of these function blocks is used to execute different application functions.

The function blocks can be connected by means of an FF configuration program, depending on the automation task. The device thus takes on simple control functions, thereby relieving the workload on the higher-order process control system.

The device has the following blocks:

- Resource Block (device block)
- 3 Transducer Blocks for all devices
 - Pressure Transducer Block
This Block returns the output variables Primary Value/PRIMARY_VALUE and Secondary Value/SECONDARY_VALUE. It contains all the parameters to configure the measuring device for the measuring task such as measuring mode selection, linearization function and unit selection.
 - Display Transducer Block
This Block does not return any output variables. It contains all the parameters for configuring the onsite display, such as Language/DISPLAY_LANGUAGE.
 - Diagnostic Transducer Block
This Block does not return any output variables. It contains the simulation function for the Pressure Transducer Block, parameters to configure the alarm response.
- In addition, 1 Transducer Block for Deltabar M
 - DP_FLOW Block
This Block supplies the output variable Totalizer 1/TOTALIZER_1 and Totalizer 2/TOTALIZER_2. It contains all the parameters required for configuring these totalizers.
- Function blocks in all devices
 - 2 Analog Input Blocks (AI) (permanent block - cannot be deleted)
 - Discrete Output Block (DO) (permanent block - cannot be deleted)
 - Discrete Input Block (DI) (permanent block - cannot be deleted)
 - Input Selector Block (ISB) (permanent block - cannot be deleted)
 - PID Block (PID) (non-permanent block - can be deleted)
 - Arithmetic Block (ARB) (non-permanent block - can be deleted)
 - Signal Characterizer Block (SCB) (non-permanent block - can be deleted)
 - Integrator Block (IT) (non-permanent block - can be deleted)

In addition to the pre-instantiated blocks already mentioned, the following blocks can also be instantiated:

With Deltabar M:

- 3 Analog Input Blocks (AI)
- 4 Discrete Input Blocks (DI)
- 1 Discrete Output Block (DO)
- 2 Input Selector Block (ISB)
- 2 PID Blocks (PID)
- 2 Arithmetic Blocks (ARTH)
- 2 Signal Characterizer Blocks (SCB)
- 2 Integrator Blocks (IT)

With Cerabar M and Deltapilot M :

- 2 Analog Input Blocks (AI)
- 4 Discrete Input Blocks (DI)
- 2 Input Selector Block (ISB)
- 2 PID Blocks (PID)
- 2 Arithmetic Blocks (ARTH)
- 2 Signal Characterizer Blocks (SCB)
- 2 Integrator Blocks (IT)

Up to 20 blocks can be instantiated in the device altogether, including the blocks already instantiated. For instantiating blocks, see the appropriate Operating Instructions of the configuration program used.



Endress+Hauser Guideline BA00062S.

The guideline provides an overview of the standard function blocks that are described in FOUNDATION Fieldbus Specifications FF 890 - 894.

It is designed to help operators use the blocks implemented in the Endress+Hauser field devices.

Block configuration when device is delivered

The block model shown below illustrates the block configuration when the device is delivered.

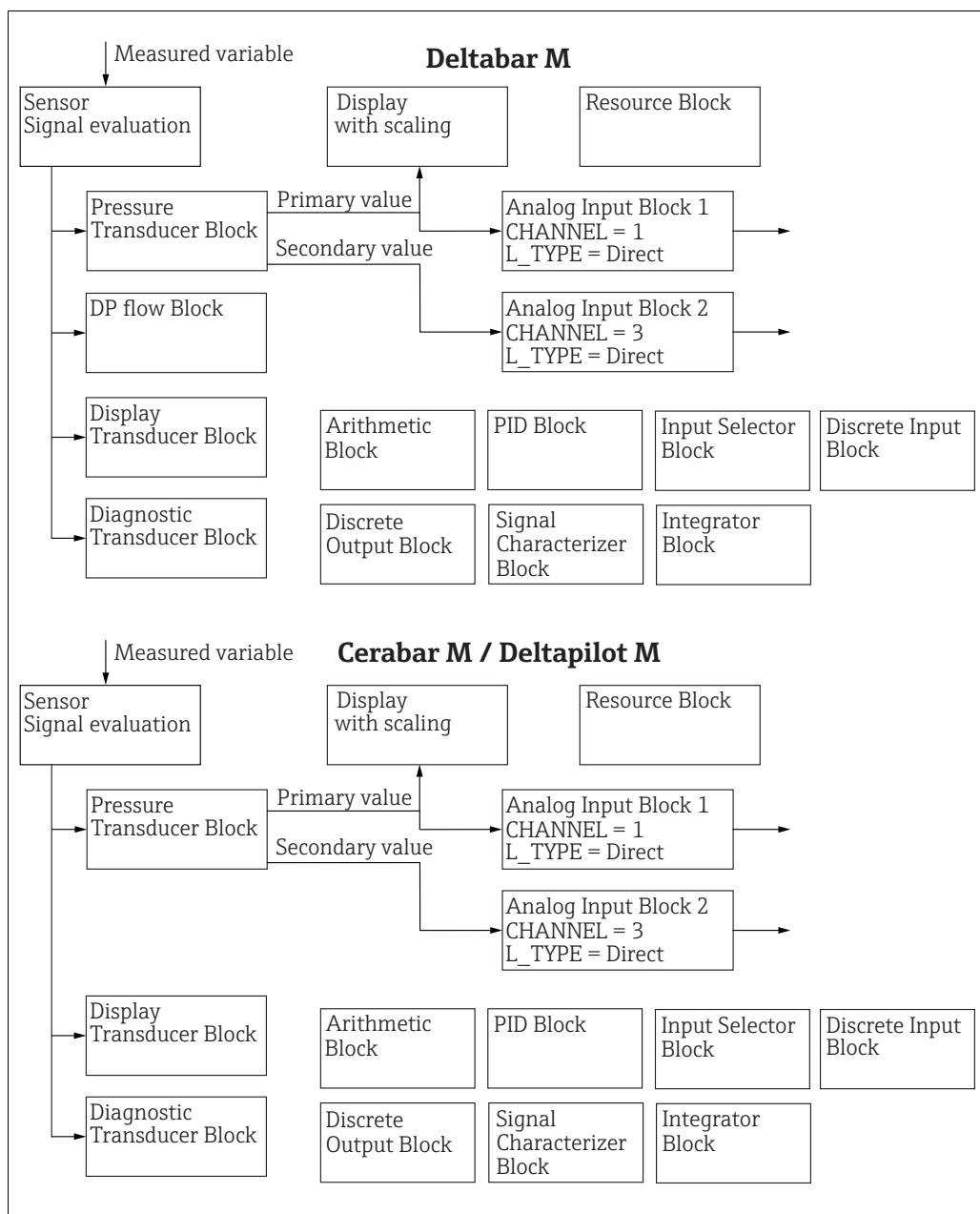

Fig. 27: Block configuration when device is delivered

The Pressure Transducer Block supplies the primary value depending on the measuring mode, and a secondary value

- for Cerabar/Deltapilot, secondary value = sensor temperature.
- for Deltabar, secondary value = Measured pressure.

By means of the Channel/CHANNEL parameter, the measured values (primary value, secondary value, etc.) are transferred to an Analog Input Block from the Transducer Block, see also the following section).

The Discrete Output, PID, Arithmetic, Signal Characterizer and Input Selector Block are not connected in the as-delivered state (IT, DI).

Deltabar M:

In the DP_FLOW Transducer Block, the flow is totalized in the "Flow" measuring mode and output by means of the Totalizer 1/TOTALIZER_1 parameter.

⚠ CAUTION**Note Dependencies when setting parameters!**

- ▶ Please note that links between the blocks are deleted and the FF parameters are reset to the default values following a reset by means of the Restart/RESTART parameter in the Resource Block, "Default" option.

6.4.7 Assignment of Transducer Blocks (CHANNEL)

Settings for the Analog Input Block

Process variable	Transducer Block	Parameter name	CHANNEL parameter in the Analog Input Block
Primary Value, a pressure, level or flow value depending on the measuring mode	Pressure Transducer Block	Primary Value/ PRIMARY_VALUE MEASURED_VALUE/ PRIMARY_VALUE	1
Temperature		Sensor temp. (Cerabar/ Deltapilot)/ MEASURED_TEMPERA TURE_1	2: Cerabar and Deltapilot
Measured pressure		Meas. pressure/ PRESSURE_1_FINAL_V ALUE	3
Maximum pressure		Max. meas. press./ PRESSURE_1_MAX_RE SETABLE	4
Level before linearization		Level before lin/ MEASURED_LEVEL_AF TER_SIMULATION	5
Deltabar M: Totalizer 1 ("Flow" measuring mode)	Deltabar M: DP_FLOW Block	Totalizer 1/ TOTALIZER_1_STRING_ VALUE TOTALIZER 1/ TOTALIZER_1_VALUE	6: Deltabar
Deltabar M: Totalizer 2 ("Flow" measuring mode)	Deltabar M: DP_FLOW Block	Totalizer 2/ TOTALIZER_2_STRING_ VALUE TOTALIZER 2/ TOTALIZER_2_VALUE	7: Deltabar

Settings for the Discrete Output Block

Process variable	Transducer Block	Parameter name	CHANNEL parameter in the Discrete Output Block
Min/max pressure values	Pressure Transducer Block	Reset peakhold/ RESET_TRANSMITTER_ OBSERVATION Reset max. pressure/ RESET_TRANSMITTER_ OBSERVATION_INDEX	20
Overshoot counter of the nominal pressure range ¹⁾	DP_FLOW Transducer Block	Reset Totalizer 1/ TOTALIZER_1_RESET	21

1) Factory setting

Discrete Input Block settings

Alarm conditions	Transducer Block	Parameter name	Parameter CHANNEL, Discrete Input Block
General device error	Diagnostic TRD	Diagnostic code/ ACTUAL_HIGHEST_ ALARM	10
Configuration error			11
Sensor overpressure			12
Sensor underpressure			13
Temperature measured value overrange (Cerabar and Deltapilot)			14
Pressure measured value overrange			15

6.4.8 Index tables of Endress+Hauser parameters

The following tables list the manufacturer-specific device parameters for the Resource Block, the Transducer Blocks and the Analog Input Blocks. For the FF parameters, see either the FF specification or descriptions from Page 138 ff.

General explanatory remarks

Data type

- DS: data structure, contains data types such as unsigned8, Octet String etc.
- Float: IEEE 754 format
- Visible String: ASCII coded
- Unsigned:
 - Unsigned8: value range = 0 to 255
 - Unsigned16: value range = 0 to 65535
 - Unsigned32: value range = 0 to 4294967295

Storage Class

- Cst: constant parameter
- D: dynamic parameter
- N: nonvolatile parameter
- S: static parameter

If this is a write parameter, the MODE_BLK column indicates the block mode in which the parameter can be written. Some parameters can only be written in the OOS block mode. The "Reset codes" column indicates which reset codes reset the parameter.

Resource Block

Parameter name, "Label parameter" option and display in FieldCare / parameter name in accordance with DD	Index	Data type	Size (Byte)	Storage Class	Read	Write	MODE_BLK	Reset codes	Page
Device dialog/DEVICE_DIALOG	42	Unsigned8	1	D	x				→ 172
Operator code/S_W_LOCK	43	Unsigned16	2	S	x	x	wr for Auto, OOS	7864, 333	→ 172
Lockstate/STATUS_LOCKING	44	Unsigned8	1	D	x				→ 172
DIP switch/SWITCH_STATUS_LIST	45	Unsigned8	1	S	x				→ 172
Electr. serial no./ ELECTRONIC_SERIAL_NUMBER	46	Visible String	16	S	x				→ 173
Sci octet str/SCI_OCTET_STRING	47	Visible String	40	D	x	x	wr for Auto, OOS		→ 173
Download select./DOWNLOAD_OVERWRITE_SELECTION	48	Unsigned8	1	D	x	x	wr for Auto, OOS		→ 173
Code definition/USER_S_W_UNLOCK	49	Unsigned16	1	S	x	x	wr for Auto, OOS		→ 173
Capability level/CAPABILITY_LEVEL	50	Unsigned8	1	D	x				→ 173
Compat. level/COMPATIBILITY_LEVEL	51	Unsigned8	1	S	x				→ 174
ENP version/FF_E_N_P_VERSION	52	Visible String	32	S	x	x			→ 174
Pd-tag/FF_PD_TAG	53	Visible String	32	D	x	x	wr for Auto, OOS		→ 174
Serial number/DEVICE_SERIAL_NUMBER	54	Visible String	16	S	x		wr for Auto, OOS		→ 174
Order code part 1/E_N_P_ORDER_CODE_1	55	Visible String	32	S	x		wr for Auto, OOS		→ 174
Order code part 2/E_N_P_ORDER_CODE_2	56	Visible String	32	S	x		wr for Auto, OOS		→ 174
Order code/DEVICE_ORDER_IDENT	57	Visible String	32	S	x		wr for Auto, OOS		→ 174
Firmware version/FF_SOFTWARE_REVISION	58	Visible String	32	S	x				→ 174
Hardware rev./FF_HARDWARE_VERSION	59	Visible String	16	S	x				→ 175
FF com stack ver/FF_COM_VERSION	60	Visible String	16	S	x				→ 175
MS res directory/MS_RES_DIRECTORY	61	Unsigned8	10	S	x				→ 175

Pressure Transducer Block

Parameter name, "Label parameter" option and display in FieldCare / parameter name in accordance with DD	Index	Data type	Size (Byte)	Storage Class	Read	Write	MODE_BLK	Reset codes	Page
Device dialog/DEVICE_DIALOG	31	Unsigned8	1	D	x				→ 182
Operator code/S_W_LOCK	32	Unsigned16	2	S	x	x	wr for Auto, OOS	7864, 333	→ 182
Lockstate/STATUS_LOCKING	33	Unsigned8	1	D	x				→ 182
DIP switch/SWITCH_STATUS_LIST	34	Unsigned8	1	D	x				→ 183
Scale In/SCALE_IN	35	DS-68	11	S	x	x	OOS	7864, 333	→ 183
Scale Out/SCALE_OUT	36	DS-68	11	S	x	x	OOS	7864, 333	→ 183
Damping/PRESSURE_1_DAMPING	37	Float	4	S	x	x	OOS	7864, 333	→ 184
Pos. zero adjust/PRESSURE_1_ACCEPT_ZERO_INSTALL	38	Unsigned8	1	D	x	x	OOS		→ 184
Calib. offset/PRESSURE_1_INSTALL_OFFSET	39	Float	4	S	x	x	OOS	7864, 333, 2509	→ 184
Lo trim measured/PRESSURE_1_LOWER_CAL_MEASURED	40	Float	4	S	x			2509	→ 184
Hi trim measured/PRESSURE_1_UPPER_CAL_MEASURED	41	Float	4	S	x			2509	→ 184
Measuring mode/OPERATING_MODE	42	Unsigned8	1	S	x	x	OOS	7864	→ 185
Level selection/LEVEL_ADJUSTMENT	43	Unsigned8	1	S	x	x	OOS	7864, 333	→ 185
Corrected press./PRESSURE_1_AFTER_CALIBRATION	44	Float	4	D	x				→ 185
Meas. pressure/PRESSURE_1_FINAL_VALUE	45	Float	4	D	x				→ 185
Lin. mode/LINEARIZATION_TABLE_MODE	46	Unsigned8	1	S	x	x	OOS	7864	→ 187
Unit after lin./AFTER_LINEARIZATION_UNIT	47	Unsigned16	1	S	x	x	OOS		→ 187
Line numb./LINEARIZATION_TABLE_INDEX	48	Unsigned8	1	D	x	x			→ 187
X-value:/TB_LINEARIZATION_TABLE_X_VALUE	49	Float	4	S	x	x	OOS	7864, 333	→ 187
Y-value:/TB_LINEARIZATION_TABLE_Y_VALUE	50	Float	4	S	x	x	OOS	7864, 333	→ 187
Edit table/LINEARIZATION_TABLE_EDIT	51	Unsigned8	1	D	x	x	OOS		→ 188
Tank Description/LEVEL_TANK_DESCRIPTION	52	Visible String	32	S	x	x	wr for Auto, OOS	7864	→ 188
Tank content/MEASURED_TANK_CONTENT_AFTER_SIM	53	Float	4	D	x				→ 188
Sensor pressure/PRESSURE_1_AFTER_SENSOR	54	Float	4	D	x				→ 188
Pressure af. damp./PRESSURE_1_AFTER_DAMPING	55	Float	4	D	x				→ 188
Level before lin./MEASURED_LEVEL_AFTER_SIMULATION	56	Float	4	D	x				→ 189
Lin tab index 01/LIN_TAB_X_Y_VALUE_1	57	Record	8	S	x	x	OOS	7864	→ 190
...	...	Record	8	S	x	x	OOS	7864	...
Lin tab index 32/LIN_TAB_X_Y_VALUE_32	88	Record	8	S	x	x	OOS	7864	→ 190
Sensor meas. type/SENSOR_MEASUREMENT_TYPE	89	Unsigned16	2	D	x				→ 190
Height unit/HEIGHT_UNIT_EASY	90	Unsigned16	2	S	x	x	OOS		→ 190
Unit before Lin./OUT_UNIT_EASY	91	Unsigned16	2	S	x	x	OOS		→ 191
Calibration mode/LEVEL_ADJUST_MODE_EASY	92	Unsigned8	1	S	x	x	OOS		→ 191
Density unit/DENSITY_UNIT_EASY	93	Unsigned16	2	D	x				→ 191
Adjust density/LEVEL_ADJUST_DENSITY_EASY	94	Float	4	S	x	x	OOS	7864, 333	→ 191
Empty height/LEVEL_OFFSET_EASY	95	Float	4	S	x	x	OOS	7864, 333	→ 192
Full height/LEVEL_100_PERCENT_EASY	96	Float	4	S	x	x	OOS	7864, 333	→ 192
Process density/LEVEL_MEASUREMENT_DENSITY_EASY	97	Float	4	S	x	x	OOS	7864, 333	→ 192
Meas. level/MEASURED_ACTUAL_LEVEL_EASY	98	Float	4	D	x				→ 192
Full calib./HIGH_LEVEL_EASY	99	Float	4	S	x	x	OOS	7864, 333	→ 192
Empty calibration/LOW_LEVEL_EASY	100	Float	4	S	x	x	OOS	7864, 333	→ 193
Full pressure/HIGH_LEVEL_PRESSURE_EASY	101	Float	4	S	x	x	OOS	7864, 333	→ 193
Empty pressure/LOW_LEVEL_PRESSURE_EASY	102	Float	4	S	x	x	OOS	7864, 333	→ 193
Electr. delta P/ELECTRIC_DELTA_P_CONTROL	103	Unsigned8	1	S	x	x	OOS		→ 193
E.delta p selec./E_DELTA_P_INPUT_SELECTOR	104	Unsigned8	1	S	x	x	OOS		→ 193
E. delta p value/E_DELTA_P_VALUE	105	Float	4	D	x				→ 193
E. delta p status/E_DELTA_P_STATUS	106	Unsigned8	1	D	x				→ 194
E.delta p unit/E_DELTA_P_INPUT_UNIT	107	Unsigned16	2	S	x	x	OOS		→ 194
Fixed ext. value/ELECTRIC_DELTA_P_CONSTANT	108	Float	4	S	x	x	OOS		→ 194
Min. meas. press./PRESSURE_1_MIN_RESETABLE	109	Float	4	D	x				→ 194
Max. meas. press./PRESSURE_1_MAX_RESETABLE	110	Float	4	D	x				→ 194
Reset peakhold/RESET_TRANSMITTER_OBSERVATION	111	Unsigned8	1	D	x	x	OOS		→ 194
Sensor temp. (Cerabar/Deltapilot)/MEASURED_TEMPERATURE_1	112	Float	4	D	x				→ 194
Temp. eng. unit/TEMPERATURE_UNIT	113	Unsigned16	2	S	x	x	OOS		→ 195
Device name str./GENERIC_DEVICE_TYPE	114	Unsigned8	1	S	x				→ 195
Format 1st value/DISPLAY_MAINLINE_FORMAT	115	Unsigned8	1	S	x				→ 195

DP_FLOW Block (Deltabar M)

Parameter name, "Label parameter" option and display in FieldCare / parameter name in accordance with DD	Index	Data type	Size (Byte)	Storage Class	Read	Write	BLK_MODE	Reset codes	Page
Device dialog/DEVICE_DIALOG	11	Unsigned8	1	D	x				→ 195
Operator code/S_W_LOCK	12	Unsigned16	2	S	x	x	wr for Auto, OOS	7864 , 333	→ 195
Lockstate/STATUS_LOCKING	13	Unsigned8	1	D	x				→ 195
DIP switch/SWITCH_STATUS_LIST	14	Unsigned8	1	D	x				→ 196
Flow meas. type/FLOW_TYPE	15	Unsigned8	1	S	x	x	OOS		→ 196
Flow/FLOW_AFTER_SUPPRESSION	16	Float	4	D	x				→ 196
Flow unit/FLOW_UNIT	17	Unsigned16	2	S	x	x	OOS	7864 , 333	→ 197
Set. L. Fl. Cut-off/CREEP_FLOW_SUPPRESSION_OFF_THRES	18	Float	4	S	x	x	OOS	7864 , 333	→ 198
Flow Max/MAX_FLOW	19	Float	4	S	x	x	OOS		→ 198
Pressure af. damp./ PRESSURE_1_AFTER_DAMPING	20	Float	4	D	x				→ 198
Max press. flow/FLOW_MAX_PRESSURE	21	Float	4	S	x	x	OOS	7864 , 333	→ 199
Press. eng. unit/PRESSURE_1_UNIT	22	Unsigned16	2	S	x	x	OOS		→ 199
Totalizer 1/TOTALIZER_1	23	DS-65	5	D	x				→ 199
Eng. unit total. 1/TOTALIZER_1_UNIT	24	Unsigned16	2	S	x	x	OOS	7864 , 333	→ 199
Totalizer 1 mode/TOTALIZER_1_MODE	25	Unsigned8	1	S	x	x	OOS		→ 199
Total. 1 failsafe/TOTALIZER_1_FAIL_SAFE_MODE	26	Unsigned8	1	S	x	x	OOS		→ 199
Reset Totalizer 1/TOTALIZER_1_RESET	27	Unsigned8	1	D	x	x	OOS		→ 200
Totalizer 1/TOTALIZER_1_STRING_VALUE	28	Visible String	8	D	x				→ 200
Totalizer 1 overflow/TOTALIZER_1_STRING_OVERFLOW	29	Visible String	8	D	x				→ 200
Totalizer 2/TOTALIZER_2	30	DS-65	5	D	x				→ 200
Eng. unit total. 2/TOTALIZER_2_UNIT	31	Unsigned16	2	S	x	x	OOS	7864 , 333	→ 200
Totalizer 2 mode/TOTALIZER_2_MODE	32	Unsigned8	1	S	x	x	OOS	7864 , 333	→ 200
Total. 2 failsafe/TOTALIZER_2_FAIL_SAFE_MODE	33	Unsigned8	1	S	x	x	OOS		→ 200
Totalizer 2/TOTALIZER_2_STRING_VALUE	34	Visible String	8	D	x				→ 201
Total. 2 overflow/TOTALIZER_2_STRING_OVERFLOW	35	Visible String	8	D	x				→ 201
Measuring mode/OPERATING_MODE	36	Unsigned8	1	D	x				→ 201
High-press. side/PRESSURE_1_INPUT_INV	37	Unsigned8	1	D	x	x	OOS	7864	→ 201
Device name str./GENERIC_DEVICE_TYPE	38	Unsigned8	1	S	x				→ 201
Format 1st value/DISPLAY_MAINLINE_FORMAT	39	Unsigned8	1	S	x				→ 201

Display Transducer Block

Parameter name, "Label parameter" option and display in FieldCare / parameter name in accordance with DD	Index	Data type	Size (Byte)	Storage Class	Read	Write	BLK_MODE	Reset codes	Page
Device dialog/DEVICE_DIALOG	10	Unsigned8	1	D	x				→ 202
Operator code/S_W_LOCK	11	Unsigned16	2	S	x	x	wr for Auto, OOS	7864 , 333	→ 202
Lockstate/STATUS_LOCKING	12	Unsigned8	1	D	x				→ 202
Format 1st value/AUTOMATIC_MAIN_LINE_FORMAT	13	Unsigned8	1	S	x	x	wr for Auto, OOS	7864	→ 202
Language/DISPLAY_LANGUAGE	14	Unsigned8	1	S	x	x	wr for Auto, OOS	7864	→ 202
Display mode/DISPLAY_MAIN_LINE_1_CONTENT	15	Unsigned8	1	S	x	x	wr for Auto, OOS		→ 202
Add. disp. value/DISPLAY_MAINLINE_2_CONTENT	16	Unsigned8	1	S	x	x	wr for Auto, OOS		→ 203
FF input source/DISPLAY_INPUT_SELECTOR	17	Unsigned8	1	S	x	x	wr for Auto, OOS		→ 203
FF input unit/DISPLAY_INPUT_UNIT	18	Unsigned16	1	S	x	x	wr for Auto, OOS		→ 203
FF input form./DISPLAY_INPUT_FORMAT	19	Unsigned8	1	S	x	x	wr for Auto, OOS		→ 203
Device name str./GENERIC_DEVICE_TYPE	20	Unsigned8	1	S	x				→ 203
Measuring mode/OPERATING_MODE	21	Unsigned8	1	D	x				→ 204

Diagnostic Transducer Block

Parameter name, "Label parameter" option and display in FieldCare / parameter name in accordance with DD	Index	Data type	Size (Byte)	Storage Class	Read	Write	BLK_MODE	Reset codes	Page
Device dialog/DEVICE_DIALOG	10	Unsigned8	1	D	x				→ 204
Operator code/S_W_LOCK	11	Unsigned16	2	S	x	x	wr for Auto, OOS	7864, 333	→ 204
Lockstate/STATUS_LOCKING	12	Unsigned8	1	D	x				→ 204
DIP switch/SWITCH_STATUS_LIST	13	Unsigned8	1	D	x				→ 204
Simulation mode/SIMULATION_MODE	14	Unsigned8	1	D	x	x	OOS		→ 205
Simulation unit/SIMULATION_UNIT	15	Unsigned8	1	D	x	x		7864	→ 206
Simulated Value/SIMULATED_VALUE	16	Float	4	D	x	x	OOS		→ 206
Sim. error no./ALARM_SIMULATION_VALUE	17	Unsigned16	2	D	x	x	OOS		→ 206
Status/DEVICE_STATUS	18	Unsigned8	1	D	x				→ 206
Diagnostic code/ACTUAL_HIGHEST_ALARM	19	Unsigned16	2	D	x				→ 206
Instructions/ACTUAL_MAINTENANCE_INSTRUCT	20	Unsigned16	2	D	x				→ 206
Last diag. code/LAST_ALARM_INFO_IO	21	Unsigned16	2	D	x				→ 206
Reset logbook/RESET_ALARM_HISTORY	22	Unsigned8	2	D	x	x	wr for Auto, OOS		→ 207
Actual errors/DIAG_ALARM_TABLE	23	OctetString8	8	D	x				→ 207
Operating hours/OPERATING_HOURS_VALUE	24	Unsigned32	4	S	x				→ 207
Diagnostic code/ACTUAL_HIGHEST_ALARM	25	Record	20	D	x				→ 207
Instructions/ACTUAL_MAINTENANCE_INSTRUCT_INFO	26	Record	20	D	x				→ 207
Last diag. code/LAST_ALARM_INFOS	27	Record	20	D	x				→ 207
Reset/RESET_INPUT_VALUE	28	Unsigned16	2	D	x	x	wr for Auto, OOS		→ 207
Config. Recorder/CONFIGURATION_COUNTER	29	Unsigned16	2	S	x				→ 207
Alarm behav. P/UNDER_OVER_PRESSURE_BEHAVIOR	30	Unsigned8	1	S	x	x	OOS		→ 208

Analog Input Blocks

Parameter name, "Label parameter" option and display in FieldCare / parameter name in accordance with DD	Index	Data type	Size (Byte)	Storage Class	Read	Write	BLK_MODE	Reset codes	Page
Fsafe type/FSAFE_TYPE FieldCare= not supported.	37	Unsigned8	1	S	x	x	OOS, MAN		→ 217
Fsafe value/FSAFE_VALUE FieldCare= not supported.	38	Float	4	S	x	x	wr for Auto, OOS, MAN		→ 217
High High Alarm Output Discrete/HIHI_ALM_OUT_D FieldCare= not supported.	39	DS66	2	D	x	x	wr for Auto, OOS, MAN		→ 217
High alarm output discrete/HI_ALM_OUT_D FieldCare= not supported.	40	DS66	2	D	x	x	wr for Auto, OOS, MAN		→ 217
Low alarm output discrete/LO_ALM_OUT_D FieldCare= not supported.	41	DS66	2	D	x	x	wr for Auto, OOS, MAN		→ 217
Low Low Alarm Output Discrete/LOLO_ALM_OUT_D FieldCare= not supported.	42	DS66	2	D	x	x	wr for Auto, OOS, MAN		→ 217
Select Alarm Mode/ALARM_MODE FieldCare= not supported.	43	Unsigned8	1	S	x	x	wr for Auto, OOS, MAN		→ 218
Alarm Output Discrete/ALM_OUT_D FieldCare= not supported.	44	DS66	2	D	x	x	wr for Auto, OOS, MAN		→ 218
Block Error Description/BLOCK_ERR_DESC_1 FieldCare= not supported.	45	Unsigned32	4	D	x		wr for Auto, OOS, MAN		→ 218

6.4.9 Methods

The FOUNDATION Fieldbus Specification includes the use of methods to make device operation easier. A method is a sequence of interactive steps to be carried out in the specified order so as to configure certain device functions.

The following methods are available for the devices:

- Device info, locking/unlocking, ENP parameters, restart (Resource Block)
- Setup, level, linearization, peak hold indicator, sensor data, sensor trim (TRD Block)
- Flow, totalizer (DP_FLOW Block = Deltabar M)
- Diagnostics, simulation, reset (Diagnostic Block)
- Display/operation (Display Block)



For further information on accessing methods, see the description of the FF configuration program used.

7 Commissioning without an operating menu

The device is configured at the factory for the Pressure measuring mode (Cerabar, Deltabar) or Level measuring mode (Deltapilot). The measuring range and the unit in which the measured value is transmitted correspond to the specifications on the nameplate.

▲ WARNING

Exceeding the maximum allowable working pressure!

Risk of injury due to bursting of parts! Warning messages are generated if pressure is too high.

- ▶ If a pressure smaller than the minimum permitted pressure or greater than the maximum permitted pressure is present at the device, the following messages are output in succession (depending on the setting in the "Alarm behavior" (050) parameter):
 "S140 Working range P" or "F140 Working range P"
 "S841 Sensor range" or "F841 Sensor range"
 "S971 Adjustment"
 Use the device only within the sensor range limits.

NOTICE



Shortfall of the allowable working pressure!

Output of messages if pressure is too low.

- ▶ If a pressure smaller than the minimum permitted pressure or greater than the maximum permitted pressure is present at the device, the following messages are output in succession (depending on the setting in the "Alarm behavior" (050) parameter):
 "S140 Working range P" or "F140 Working range P"
 "S841 Sensor range" or "F841 Sensor range"
 "S971 Adjustment"
 Use the device only within the sensor range limits.

7.1 Function check

Carry out a post-installation and a post-connection check as per the checklist before commissioning the device.

- "Post-installation check" checklist →  37
- "Post-connection check" checklist →  43

7.2 Position adjustment

The following functions are possible by means of the key on the electronic insert:

- Position adjustment (zero point correction)
- Device reset →  47



- Operation must be unlocked. →  54, "Locking/unlocking operation"
- The device is configured for the "Pressure" measuring mode as standard.
- The pressure applied must be within the nominal pressure limits of the sensor. See information on the nameplate.

Carrying out position adjustment ¹⁾
Pressure is present at device.
↓
Press the "Zero" key for at least 3 s.
↓

Carrying out position adjustment ¹⁾	
Does the LED on the electronic insert light up briefly?	
Yes	No
↓	↓
Applied pressure for position adjustment has been accepted.	Applied pressure for position adjustment has not been accepted. Observe the input limits.

- 1) Observe warning on commissioning

8 Commissioning with an operating menu (onsite display/FieldCare)

The device is configured at the factory for the Pressure measuring mode (Cerabar, Deltabar) or Level measuring mode (Deltapilot). The measuring range and the unit in which the measured value is transmitted correspond to the specifications on the nameplate.

▲ WARNING

Exceeding the maximum allowable working pressure!

Risk of injury due to bursting of parts! Warning messages are generated if pressure is too high.

- ▶ If a pressure smaller than the minimum permitted pressure or greater than the maximum permitted pressure is present at the device, the following messages are output in succession (depending on the setting in the "Alarm behavior" (050) parameter):
 "S140 Working range P" or "F140 Working range P"
 "S841 Sensor range" or "F841 Sensor range"
 "S971 Adjustment"
 Use the device only within the sensor range limits.

NOTICE



Shortfall of the allowable working pressure!

Output of messages if pressure is too low.

- ▶ If a pressure smaller than the minimum permitted pressure or greater than the maximum permitted pressure is present at the device, the following messages are output in succession (depending on the setting in the "Alarm behavior" (050) parameter):
 "S140 Working range P" or "F140 Working range P"
 "S841 Sensor range" or "F841 Sensor range"
 "S971 Adjustment"
 Use the device only within the sensor range limits.









8.1 Function check

Carry out a post-installation and a post-connection check as per the checklist before commissioning the device.

- "Post-installation check" checklist →  37
- "Post-connection check" checklist →  43

8.2 Commissioning

Commissioning comprises the following steps:

1. Function check (→  71)
2. Selecting the language, measuring mode and pressure unit (→  71)
3. Position adjustment (→  73)
4. Configuring measurement:
 - Pressure measurement (→  90 ff)
 - Level measurement (Cerabar M and Deltapilot M) (→  74 ff)
 - Linearization (→  84 ff)
 - Differential pressure measurement (Deltabar M) (→  91 ff)
 - Flow measurement (Deltabar M) (→  93 ff)
 - Level measurement (Deltabar M) (→  96 ff)

8.2.1 Selecting the language, measuring mode and pressure unit

Language selection

Parameter name	Description
Language (000) Options Menu path: Main menu → Language	Select the menu language for the onsite display. Options: <ul style="list-style-type: none"> ▪ English ▪ Possibly another language (as selected when ordering the device) ▪ One further language (language of the manufacturing plant) Factory setting: English

Measuring mode selection

Parameter name	Description
Measuring mode (005) Options Menu path: Setup → Measuring mode	Select the measuring mode. The operating menu is structured differently depending on the measuring mode selected. ⚠ WARNING Changing the measuring mode affects the span (URV)! This situation can result in product overflow. <ul style="list-style-type: none"> ▶ If the measuring mode is changed, the span setting (URV) must be verified and, if necessary, reconfigured! Options: <ul style="list-style-type: none"> ▪ Pressure ▪ Level ▪ Flow Factory setting: Pressure

Pressure unit selection

Parameter name	Description
Press. eng. unit (125) Options Menu path: Setup → Press. eng. unit	Select the pressure unit. If a new pressure unit is selected, all pressure-specific parameters are converted and displayed with the new unit. Options: <ul style="list-style-type: none"> ▪ mbar, bar ▪ mmH₂O, mH₂O, ▪ inH₂O, ftH₂O ▪ Pa, kPa, MPa ▪ psi ▪ mmHg, inHg ▪ kgf/cm² Factory setting: mbar or bar depending on the sensor nominal measuring range, or as per order specifications

8.3 Pos. zero adjust

The pressure resulting from the orientation of the device can be corrected here.

Parameter name	Description
<p>Corrected press. (172) Display</p> <p>Menu path: Setup → Corrected press.</p>	<p>Displays the measured pressure after sensor trim and position adjustment.</p> <p></p> <p>If this value is not equal to "0", it can be corrected to "0" by the position adjustment.</p>
<p>Pos. zero adjust (007) (Deltabar M and gauge pressure sensor) Selection</p> <p>Menu path: Setup → Pos. zero adjust</p>	<p>Position adjustment – the pressure difference between zero (set point) and the measured pressure need not be known.</p> <p>Example:</p> <ul style="list-style-type: none"> - Measured value = 2.2 mbar (0.032 psi) - You correct the measured value via the "Pos. zero adjust" parameter with the "Confirm" option. This means that you are assigning the value 0.0 to the pressure present. - Measured value (after pos. zero adjust) = 0.0 mbar <p>Options</p> <ul style="list-style-type: none"> ▪ Confirm ▪ Abort <p>Factory setting: Abort</p>
<p>Calib. offset (192) / (008) (absolute pressure sensor) Entry</p> <p>Menu path: Setup → Calib. offset</p>	<p>Position adjustment – the pressure difference between the set point and the measured pressure must be known.</p> <p>Example:</p> <ul style="list-style-type: none"> - Measured value = 982.2 mbar (14.24 psi) - You correct the measured value with the value entered (e.g. 2.2 mbar (0.032 psi)) via the "Calib. offset" parameter. This means that you are assigning the value 980.0 (14.21 psi) to the pressure present. - Measured value (after calib. offset) = 980.0 mbar (14.21 psi) <p>Factory setting: 0.0</p>

8.4 Level measurement (Cerabar M and Deltapilot M)

8.4.1 Information on level measurement

- The limit values are not checked, i.e. the values entered must be appropriate for the sensor and the measuring task for the device to be able to measure correctly.
- Customer-specific units are not possible.
- There is no unit conversion.
- The values entered for "Empty calib. (028)/Full calib. (031)", "Empty pressure (029)/Full pressure (032)", "Empty height (030)/Full height (033)" must be at least 1 % apart. The value will be rejected, and a warning message displayed, if the values are too close together.

You have a choice of two methods for calculating the level: "In pressure" and "In height". The table in the "Overview of level measurement" section that follows provides you with an overview of these two measuring tasks.

8.4.2 Overview of level measurement

Measuring task	Level selection	Measured variable options	Description	Measured value display
Calibration is performed by entering two pressure-level value pairs.	"In pressure"	Via the "Unit before lin. (025)" parameter: %, level, volume or mass units.	<ul style="list-style-type: none"> - Calibration with reference pressure (wet calibration), see → 75 - Calibration without reference pressure (dry calibration), see → 77 	The measured value display and the "Level before lin. (019)" parameter display the measured value.
Calibration is performed by entering the density and two height-level value pairs.	"In height"		<ul style="list-style-type: none"> - Calibration with reference pressure (wet calibration), see → 81 - Calibration without reference pressure (dry calibration), see → 79 	

8.4.3 "In pressure" level selection Calibration with reference pressure (wet calibration)

Example:

In this example, the level in a tank should be measured in "m". The maximum level is 3 m (9.8 ft). The pressure range is due to the filling height and the density.

Prerequisite:

- The measured variable is in direct proportion to the pressure.
- The tank can be filled and emptied.



The values entered for "Empty calib. (028)/Full calib. (031)" and the pressures present at the device must be at least 1% apart. The value will be rejected, and a warning message displayed, if the values are too close together. Further limit values are not checked; i.e. the values entered must be appropriate for the sensor and the measuring task so that the measuring device can measure correctly.

Description	
1	Perform "position adjustment" → 73.
2	Select the "Level" measuring mode via the "Measuring mode (005)" parameter. Menu path: Setup → Measuring mode (005)
3	Select a pressure unit by means of the "Press. eng. unit (125)" parameter, here "mbar" for example. Menu path: Setup → Press. eng. unit (125)
4	Select the "In pressure" level mode by means of the "Level selection (024)" parameter. Menu path: Setup → Extended Setup → Level → Level selection (024)

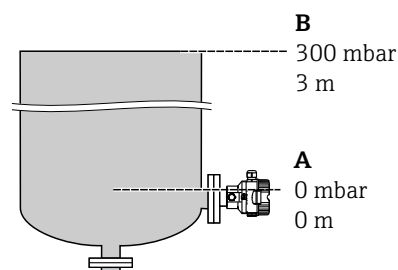

B
300 mbar
3 m

A
0 mbar
0 m

A0030028

Fig. 28: Calibration with reference pressure – wet calibration

A See Table, Step 7.
B See Table, Step 8.

Description	
5	Select a level unit by means of the "Unit before lin. (025)" parameter, here "m" for example. Menu path: Setup → Extended Setup → Level → Unit before lin. (025)
6	Select the "Wet" option by means of the "Calibration mode (027)" parameter. Menu path: Setup → Extended Setup → Level → Calibration mode (027)
7	The pressure for the lower calibration point is present at the device, here 0 mbar for example. Select the "Empty calib. (028)" parameter. Menu path: Setup → Extended Setup → Level → Empty calib. (028) Enter the level value, here 0 m for example. The pressure value present is assigned to the lower level value by confirming the value.
8	The pressure for the upper calibration point is present at the device, here 300 mbar (4.35 psi) for example. Select the "Full calib. (031)" parameter. Menu path: Setup → Extended Setup → Level → Full calib. (031) Enter the level value, here 3 m (9.8 ft) for example. The pressure value present is assigned to the upper level value by confirming the value.
9	If calibration is performed with a medium other than the process medium, enter the density of the calibration medium in "Adjust density (034)". Menu path: Setup → Extended Setup → Level → Adjust density (034)
10	If calibration was performed with a medium other than the process medium, specify the density of the process medium in the "Process density (035)" parameter. Menu path: Setup → Extended Setup → Level → Process density (035)
11	Result: The measuring range is set for 0 to 3 m (9.8 ft).

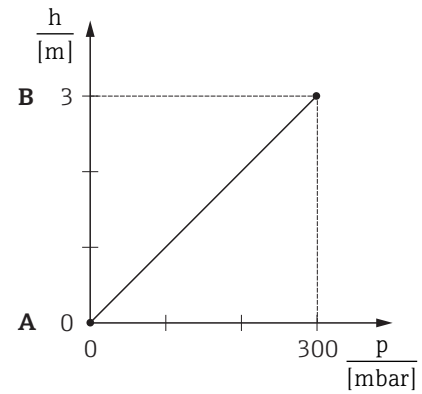

A0017658

Fig. 29: Calibration with reference pressure – wet calibration

C See Table, Step 7.
D See Table, Step 8.



The measured variables %, level, volume and mass are available for this level mode. See → 123 "Unit before lin. (025)".

8.4.4 "In pressure" level selection Calibration without reference pressure (dry calibration)

Example:

In this example, the volume in a tank should be measured in liters. The maximum volume of 1000 liters (264 gal) corresponds to a pressure of 450 mbar (6.53 psi). The minimum volume of 0 liters corresponds to a pressure of 50 mbar (0.72 psi) since the device is mounted below the start of the level measuring range.

Prerequisite:

- The measured variable is in direct proportion to the pressure.
- This is a theoretical calibration i.e. the pressure and volume values for the lower and upper calibration point must be known.



- The values entered for "Empty calib. (028)/Full calib. (031)", "Empty pressure (029)/Full pressure (032)" must be at least 1% apart. The value will be rejected, and a warning message displayed, if the values are too close together. Further limit values are not checked; i.e. the values entered must be appropriate for the sensor and the measuring task so that the measuring device can measure correctly.
- Due to the orientation of the device, there may be pressure shifts in the measured value, i.e. when the container is empty or partly filled, the measured value is not zero. For information on how to perform position adjustment, see → 73, "Pos. zero adjust".

Description	
1	Select the "Level" measuring mode via the "Measuring mode (005)" parameter. Menu path: Setup → Measuring mode (005)
2	Select a pressure unit by means of the "Press. eng. unit (125)" parameter, here "mbar" for example. Menu path: Setup → Press. eng. unit (125)
3	Select the "In pressure" level mode by means of the "Level selection (024)" parameter. Menu path: Setup → Extended Setup → Level → Level selection (024)
4	Select a volume unit by means of the "Unit before lin. (025)" parameter, here "l" (liter) for example. Menu path: Setup → Extended Setup → Level → Unit before lin. (025)

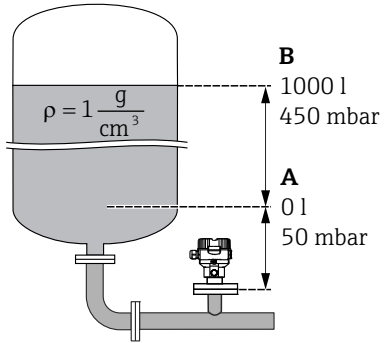

Fig. 30: Calibration without reference pressure – dry calibration

A See Table, Step 7.
C See Table, Step 8.
B See Table, Step 9.
D See Table, Step 10.

Description	
5	Select the "Dry" option by means of the "Calibration mode (027)" parameter. Menu path: Setup → Extended Setup → Level → Calibration mode (027)
6	"Adjust density (034)" contains the factory setting 1.0, but this value can be changed if required. The entered value pairs must correspond to this density. Menu path: Setup → Extended Setup → Level → Adjust density (034)
7	Enter the volume value for the lower calibration point via the "Empty calib. (028)" parameter, here 0 liters for example. Menu path: Setup → Extended Setup → Level → Empty calib. (028)
8	Enter the pressure value for the lower calibration point via the "Empty pressure (029)" parameter, here 50 mbar (0.72 psi) for example. Menu path: Setup → Extended Setup → Level → Empty pressure (029)
9	Enter the volume value for the upper calibration point via the "Full calib. (031)" parameter, here 1000 liters (264 gal) for example. Menu path: Setup → Extended Setup → Level → Full calib. (031)
10	Enter the pressure value for the upper calibration point via the "Full pressure (032)" parameter, here 450 mbar (6.53 psi) for example. Menu path: Setup → Extended Setup → Level → Full pressure (032)
11	If calibration was performed with a medium other than the process medium, specify the density of the process medium in the "Process density (035)" parameter. Menu path: Setup → Extended Setup → Level → Process density (035)
12	Result: The measuring range is set for 0 to 1000 l (264 gal).

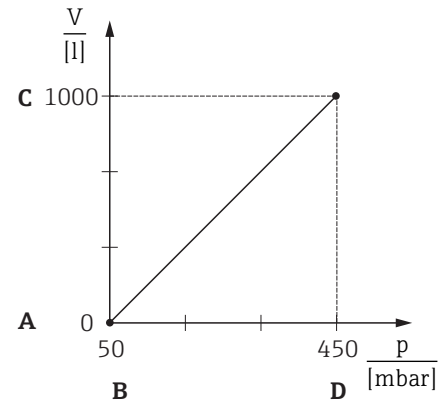

Fig. 31: Calibration with reference pressure – wet calibration

- E See Table, Step 7.
- F See Table, Step 8.
- G See Table, Step 9.
- H See Table, Step 10.



The measured variables %, level, volume and mass are available for this level mode.
See → 123 **Unit before lin. (025)**.

8.4.5 "In height" level selection Calibration without reference pressure (dry calibration)

Example:

In this example, the volume in a tank should be measured in liters. The maximum volume of 1000 liters (264 gal) corresponds to a level of 4.5 m (14.8 ft). The minimum volume of 0 liters corresponds to a level of 0.5 m (1.6 ft) since the device is mounted below the start of the level measuring range.

Prerequisite:

- The measured variable is in direct proportion to the pressure.
- This is a theoretical calibration i.e. the height and volume values for the lower and upper calibration point must be known.



- The values entered for "Empty calib. (028)/Full calib. (031)", "Empty height (030)/Full height (033)" must be at least 1% apart. The value will be rejected, and a warning message displayed, if the values are too close together. Further limit values are not checked; i.e. the values entered must be appropriate for the sensor and the measuring task so that the measuring device can measure correctly.
- Due to the orientation of the device, there may be pressure shifts in the measured value, i.e. when the container is empty or partly filled, the measured value is not zero. For information on how to perform position adjustment, see → 73, "Pos. zero adjust".

Description	
1	Select the "Level" measuring mode via the "Measuring mode (005)" parameter. Menu path: Setup → Measuring mode (005)
2	Select a pressure unit via the "Press. eng. unit (125)" parameter, here "mbar" for example. Menu path: Setup → Press. eng. unit (125)
3	Select the "In height" level mode via the "Level selection (024)" parameter. Menu path: Setup → Extended Setup → Level → Level selection (024)
4	Select a volume unit via the "Unit before lin. (025)" parameter, here "l" (liter) for example. Menu path: Setup → Extended Setup → Level → Unit before lin. (025)
5	Select a level unit by means of the "Height unit (026)" parameter, here "m" for example. Menu path: Setup → Extended Setup → Level → Height unit (026)
6	Select the "Dry" option by means of the "Calibration mode (027)" parameter. Menu path: Setup → Extended Setup → Level → Calibration mode (027)
7	Enter the density of the medium via the "Adjust density (034)" parameter, here "1 g/cm ³ " (1 SGU) for example. Menu path: Setup → Extended Setup → Level → Adjust density (034)

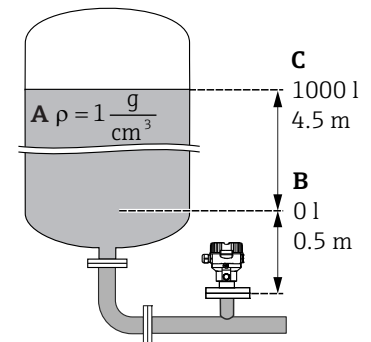

Fig. 32: Calibration without reference pressure – dry calibration

- A See Table, Step 7.
- B See Table, Steps 8 and 9.
- C See Table, Steps 10 and 11..

Description	
8	<p>Enter the volume value for the lower calibration point via the "Empty calib. (028)" parameter, here 0 liters for example.</p> <p>Menu path: Setup → Extended Setup → Level → Empty calib. (028)</p>
9	<p>Enter the height value for the lower calibration point via the "Empty height (030)" parameter, here 0.5 m (1.6 ft) for example.</p> <p>Menu path: Setup → Extended Setup → Level → Empty height (030)</p>
10	<p>Enter the volume value for the upper calibration point via the "Full calib. (031)" parameter, here 1000 liters (264 gal) for example.</p> <p>Menu path: Setup → Extended Setup → Level → Full calib. (031)</p>
11	<p>Enter the height value for the upper calibration point via the "Full height (033)" parameter, here 4.5 m (14.8 ft) for example.</p> <p>Menu path: Setup → Extended Setup → Level → Full height (033)</p>
12	<p>If the process uses a medium other than that on which the calibration was based, the new density must be specified in the "Process density (035)" parameter.</p> <p>Menu path: Setup → Extended Setup → Level → Process density (035)</p>
13	<p>Result: The measuring range is set for 0 to 1000 l (264 gal).</p>

Fig. 33: Calibration with reference pressure – wet calibration

A See Table, Step 7.
 B See Table, Step 8.
 C See Table, Step 9.
 D See Table, Step 10.
 E See Table, Step 11.



The measured variables %, level, volume and mass are available for this level mode → 123 "Unit before lin. (025)".

8.4.6 "In height" level selection Calibration with reference pressure (wet calibration)

Example:

In this example, the volume in a tank should be measured in liters. The maximum volume of 1000 liters (264 gal) corresponds to a level of 4.5 m (14.8 ft). The minimum volume of 0 liters corresponds to a level of 0.5 m (1.6 ft) since the device is mounted below the start of the level measuring range.

The density of the medium is 1 g/cm³ (1 SGU).

Prerequisite:

- The measured variable is in direct proportion to the pressure.
- The tank can be filled and emptied.



The values entered for "Empty calib. (028)/Full calib. (031)" and the pressure values present at the device must be at least 1% apart. The value will be rejected, and a warning message displayed, if the values are too close together. Further limit values are not checked; i.e. the values entered must be appropriate for the sensor and the measuring task so that the measuring device can measure correctly.

Description	
1	Perform position adjustment. See → 73.
2	Select the "In height" level mode via the "Level selection (024)" parameter. Menu path: Setup → Extended Setup → Level → Level selection (024)
3	Select the "Level" measuring mode via the "Measuring mode (005)" parameter. Menu path: Setup → Measuring mode (005)
4	Select a pressure unit via the "Press. eng. unit (125)" parameter, here "mbar" for example. Menu path: Setup → Press. eng. unit (125)
5	Select a volume unit via the "Unit before lin. (025)" parameter, here "l" (liter) for example. Menu path: Setup → Extended Setup → Level → Unit before lin. (025)

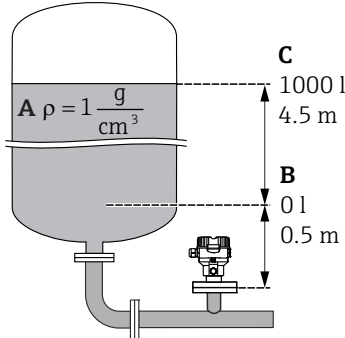

Fig. 34: Calibration with reference pressure – wet calibration

A See Table, Step 8.
 B See Table, Step 9.
 C See Table, Step 10.

Description	
6	Select a level unit by means of the "Height unit (026)" parameter, here "m" for example. Menu path: Setup → Extended Setup → Level → Height unit (026)
7	Select the "Wet" option by means of the "Calibration mode (027)" parameter. Menu path: Setup → Extended Setup → Level → Calibration mode (027)
8	If calibration is performed with a medium other than the process medium, enter the density of the calibration medium in the "Adjust density (034)" parameter, here 1 g/cm ³ (1 SGU) for example. Menu path: Setup → Extended Setup → Level → Adjust density (034)
9	The pressure for the lower calibration point is present at the device, here 0.5 m covered / 49 mbar (0.71 psi) for example. Enter the volume value for the lower calibration point via the "Empty calib. (028)" parameter, here 0 liters for example. (The pressure currently measured is displayed as the height, here 0.5 m (1.6 ft) for example.) Menu path: Setup → Extended Setup → Level → Empty calib. (028)
10	The pressure for the upper calibration point is present at the device, here 4.5 m covered / 441 mbar (6.4 psi) for example. Enter the volume value for the upper calibration point via the "Full calib. (031)" parameter, here "1000 liters" (264 gal) for example. The pressure currently measured is displayed as the height, here "4.5 m" (14.8 ft) for example. Menu path: Setup → Extended Setup → Level → Full calib. (031)
11	If calibration was performed with a medium other than the process medium, specify the density of the process medium in the "Process density (035)" parameter. Menu path: Setup → Extended Setup → Level → Process density (035)
12	Result: The measuring range is set for 0 to 1000 l (264 gal).











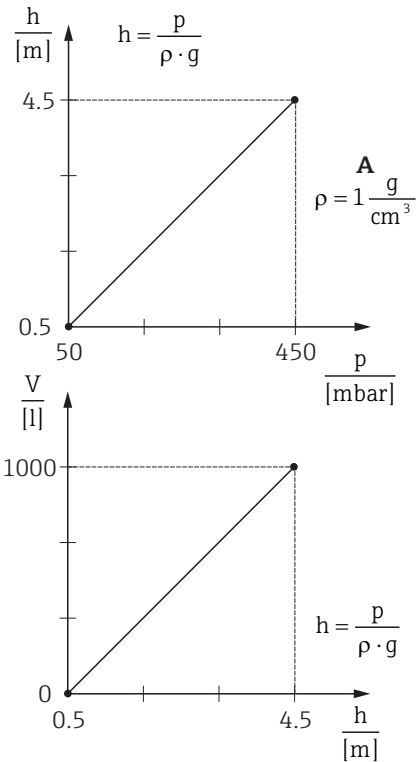





Abb. 35: Abgleich mit Referenzdruck – Nassabgleich

- A Siehe Tabelle, Schritt 8.
- B Siehe Tabelle, Schritt 9.
- C Siehe Tabelle, Schritt 10.



The measured variables %, level, volume and mass are available for this level mode
→ 123 "Unit before lin. (025)".

8.4.7 Required parameters for Level measuring mode

Parameter name	Description
Level selection (024)	→  123
Unit before lin. (025)	→  123
Height unit (026)	→  123
Calibration mode (027)	→  123
Empty calib. (028)	→  124
Empty pressure (029)	→  124
Empty height (030)	→  124
Full calib. (031)	→  124
Full pressure (032)	→  124
Full height (033)	→  124
Density unit (127)	→  125
Adjust density (034)	→  125
Process density (035)	→  125
Level before lin. (019)	→  125

8.5 Linearization

8.5.1 Manual entry of the linearization table via onsite display

Example:

In this example, the volume in a tank with a conical outlet should be measured in m^3 .

Prerequisite:

- This is a theoretical calibration, i.e. the points for the linearization table are known.
- A level calibration has been performed.



For a description of the parameters mentioned, → Chap. 8.11 "Description of parameters".

Description	
1	<p>Select the "Manual entry" option via the "Lin. mode (037)" parameter.</p> <p>Menu path: Setup → Extended Setup → Linearization → Lin. mode (037)</p>
2	<p>Select a unit via the "Unit after lin. (038)" parameter, e.g. m^3.</p> <p>Menu path: Setup → Extended Setup → Linearization → Unit after lin. (038)</p>
3	<p>Enter the number of the point in the table via the "Line numb. (039)" parameter.</p> <p>Menu path: Setup → Extended Setup → Linearization → Line numb. (039)</p>
	<p>The level is entered via the "X-value (040) (manual entry)" parameter, here 0 m for example. Confirm your entry.</p> <p>Menu path: Setup → Extended Setup → Linearization → X-value (040) (manual entry)</p>
	<p>Using the "Y-value (041) (manual entry/in semi-auto. entry)" parameter, enter the associated volume value, here 0 m^3 for example, and confirm the value.</p> <p>Menu path: Setup → Extended Setup → Linearization → Y-value (041) (manual entry/in semi-auto. entry)</p>

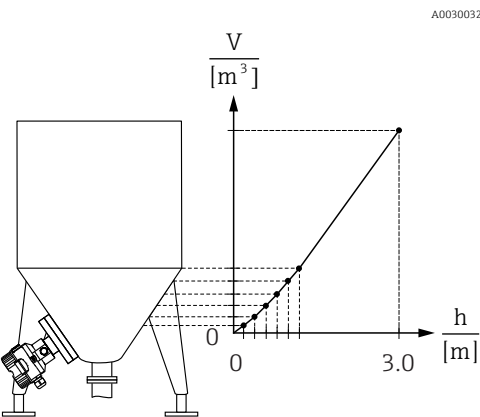

A0030032

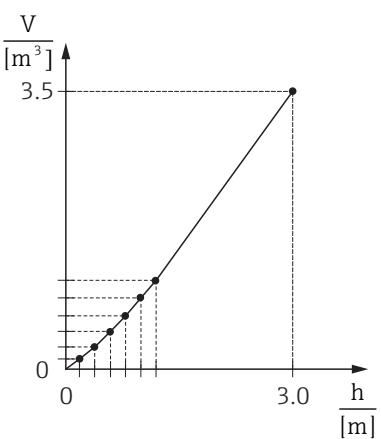

	Description	
4	To enter another point in the table, select the "Next point" option via the "Edit table (042)" parameter. Enter the next point as explained in Step 3. Menu path: Setup → Extended Setup → Linearization → Edit table (042)	
5	Once all the points have been entered in the table, select the "Activate table" option via the "Lin. mode" parameter.Lin. mode (037) Menu path: Setup → Extended Setup → Linearization → Lin. mode (037)	
6	Result: The measured value after linearization is displayed.	



Error message F510 "Linearization" and status signal "failure" appears as long as the table is being entered and until the table is activated.

8.5.2 Manual entry of the linearization table via the operating tool

Example:

In this example, the volume in a tank with a conical outlet should be measured in m³.

Prerequisite:

- This is a theoretical calibration, i.e. the points for the linearization table are known.
- The "Level" operating mode has been selected.
- A level calibration has been performed.



For a description of the parameters mentioned, → Chap. 8.11 "Description of parameters".

Description	
1	<p>Select the "Manual entry" option via the "Lin. mode (037)" parameter.</p> <p>Menu path: Setup → Extended Setup → Linearization → Lin. mode (037)</p>
2	<p>Select via the "Unit after lin. (038)" parameter, e.g. m³.</p> <p>Menu path: Setup → Extended Setup → Linearization → Unit after lin. (038)</p>
3	<p>Enter the number of the point in the table via the "Line numb. (039)" parameter.</p> <p>Menu path: Setup → Extended Setup → Linearization → Line numb. (039)</p> <p>The level is entered via the "X-value (040) (manual entry)" parameter, here 0 m for example. Confirm your entry.</p> <p>Menu path: Setup → Extended Setup → Linearization → X-value (040) (manual entry)</p> <p>Using the "Y-value (041) (manual entry/in semi-auto. entry)" parameter, enter the associated volume value, here 0 m³ for example, and confirm the value.</p> <p>Menu path: Setup → Extended Setup → Linearization → Y-value (041) (manual entry/in semi-auto. entry)</p>

A0030032

	Description	
4	To enter another point in the table, select the "Next point" option via the "Edit table (042)" parameter. Enter the next point as explained in Step 3. Menu path: Setup → Extended Setup → Linearization → Edit table (042)	
5	Once all the points have been entered in the table, select the "Activate table" option via the "Lin. mode" parameter.Lin. mode (037) Menu path: Setup → Extended Setup → Linearization → Lin. mode (037)	
6	Result: The measured value after linearization is displayed.	



Error message F510 "Linearization" and alarm current appears as long as the table is being entered and until the table is activated.

8.5.3 Semi-automatic entry of the linearization table

Example:

In this example, the volume in a tank with a conical outlet should be measured in m³.

Prerequisite:

- The tank can be filled or emptied. The linearization characteristic must rise continuously.
- A level calibration has been performed.



For a description of the parameters mentioned → Chap. 8.11 "Description of parameters".

Description	
1	Select the "Semi-auto. entry" option via the "Lin. mode (037)" parameter. Menu path: Setup → Extended Setup → Linearization → Lin. mode (037)
2	Select the volume unit/mass unit via the "Unit after lin. (038)" parameter, e.g. m ³ . Menu path: Setup → Extended Setup → Linearization → Unit after lin. (038)
3	Fill the tank to the height of the 1st point.
4	Enter the number of the point in the table via the "Line numb. (039)" parameter. Menu path: Setup → Extended Setup → Linearization → Line numb. (039)
	The actual level is displayed via the "X-value (040) (manual entry)" parameter. Menu path: Setup → Extended Setup → Linearization → X-value (040) (manual entry)
	Using the "Y-value (041) (manual entry/in semi-auto. entry)" parameter, enter the associated volume value, here 0 m ³ for example, and confirm the value. Menu path: Setup → Extended Setup → Linearization → Y-value (041) (manual entry/in semi-auto. entry)
5	To enter another point in the table, select the "Next point" option via the "Edit table (042)" parameter. Enter the next point as explained in Step 4. Menu path: Setup → Extended Setup → Linearization → Edit table (042)
6	Once all the points have been entered in the table, select the "Activate table" option via the "Lin. mode (037)" parameter. Menu path: Setup → Extended Setup → Linearization → Lin. mode (037)
7	Result: The measured value after linearization is displayed.

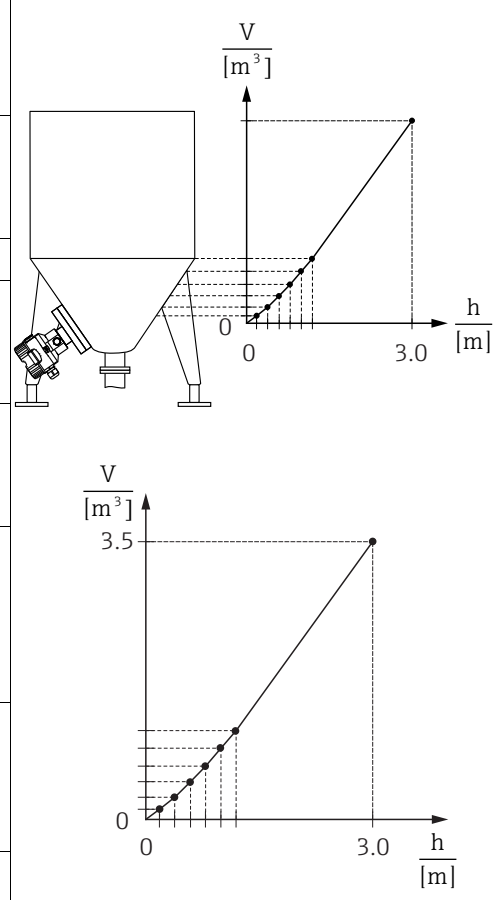









A0030032



Error message F510 "Linearization" and status signal "failure" appears as long as the table is being entered and until the table is activated.

8.5.4 Required parameters for linearization

Parameter name	Description
Lin. mode (037)	→  125
Unit after lin. (038)	→  126
Line numb. (039)	→  126
X-value (040) (manual entry)	→  126
Y-value (041) (manual entry/in semi-auto. entry)	→  126
Edit table (042)	→  126
Tank description (173)	→  126
Tank content (043)	→  126

8.6 Pressure measurement

8.6.1 Calibration without reference pressure (dry calibration)



Calibration is possible only using FieldCare.

Example:

In this example, a device with a 400 mbar (6 psi) sensor is configured for the 0 to +300 mbar (4.35 psi) measuring range, i.e. 0 mbar and 300 mbar (4.35 psi) are assigned.

Prerequisite:

This is a theoretical calibration, i.e. the pressure values for the lower and upper range are known.



Due to the orientation of the device, there may be pressure shifts in the measured value, i.e. the measured value is not zero in a pressureless condition. For information on how to perform position adjustment, see → [73](#).

	Description
1	Select the "Pressure" measuring mode via the " Measuring mode (005) " parameter. Menu path: Setup → Measuring mode (005)
2	Select a pressure unit via the "Scale in. Press. eng. unit" element, here "mbar" for example. Menu path: Setup → Scale in. Press. eng. unit
3	Enter a pressure value of 0 mbar via the "Scale in. Set LRV" element. Menu path: Expert → Communication → Pressure Transducer Block → Scale in. Set LRV
4	Enter a pressure value of 300 mbar (4.35 psi) via the "Scale in. Set LRV" element. Menu path: Expert → Communication → Pressure Transducer Block → Scale in. Set LRV
5	Result: The measuring range is configured for 0 to +300 mbar (4.35 psi).

8.6.2 Required parameters for Pressure measuring mode

Parameter name	Description
Measuring mode (005)	→ 119
Switch P1/P2 (163)	→ 121
High-pressure side (006) (Deltabar)	→ 121
Press. eng. unit (125)	→ 120
Corrected press. (172)	→ 122
Pos. zero adjust (007) (Deltabar M and gauge pressure sensor)	→ 120
Damping switch (164)	→ 120
Damping value (017)	→ 120
Pressure af. damp (111)	→ 122

8.7 Differential pressure measurement (Deltabar M)

8.7.1 Preparatory steps



Before calibrating the device, the impulse piping must be cleaned and filled with medium.
 → See the following table.











	Valves	Meaning	Preferred installation
1	Close 3.		<p style="text-align: right;">A0030036</p>
2	Fill measuring system with medium.		
	Open A, B, 2, 4.	Medium flows in.	
3	Clean impulse piping if necessary: ¹⁾ - by blowing out with compressed air in the case of gases - by rinsing out in the case of liquids.		
	Close 2 and 4.	Block off device.	
	Open 1 and 5. ¹⁾	Blow out/rinse out impulse piping.	
	Close 1 and 5. ¹⁾	Close valves after cleaning.	
4	Vent device.		
	Open 2 and 4.	Introduce medium.	
	Close 4.	Close low-pressure side.	
	Open 3.	Balance positive and low-pressure side.	
	Open 6 and 7 briefly, then close them again.	Fill device completely with medium and remove air.	
5	Set measuring point in operation.		
	Close 3.	Shut off high-pressure side from low-pressure side.	
	Open 4.	Connect low-pressure side.	
	Now - 1 ¹⁾ , 3, 5 ¹⁾ , 6 and 7 are closed. - 2 and 4 are open. - A and B open (if present).		
6	Carry out calibration if necessary. → See also page 92.		

Above: preferred installation for gases
 Below: preferred installation for liquids

- I Deltabar M
- II Three-valve manifold
- III Separator
- 1, 5 Drain valves
- 2, 4 Inlet valves
- 3 Equalizing valve
- 6, 7 Vent valves on Deltabar M
- A, B Shut-off valve

1) for arrangement with 5 valves

8.7.2 Required parameters for differential pressure via Pressure measuring mode

Parameter name	Description
Measuring mode (005)	→  119
Switch P1/P2 (163)	→  121
High-pressure side (006) (Deltabar)	→  121
Press. eng. unit (125)	→  120
Corrected press. (172)	→  122
Pos. zero adjust (007) (Deltabar M and gauge pressure sensor)	→  120
Calib. offset (192) / (008) (absolute pressure sensor)	→  120
Damping switch (164)	→  120
Damping value (017)	→  120
Pressure af. damp (111)	→  122

8.8 Flow measurement (Deltabar M)

8.8.1 Information on flow measurement

In the "Flow" measuring mode, the device determines a volume or mass flow value from the differential pressure measured. The differential pressure is generated by means of primary elements such as pitot tubes or orifice plates and depends on the volume or mass flow. Four flow types are available: volume flow, norm volume flow (European norm conditions), standard volume flow (American standard conditions), mass flow and flow in %.

In addition, the Deltabar M software is equipped with two totalizers as standard. The totalizers add up the volume or the mass flow. The counting function and the unit can be set separately for both totalizers. The first totalizer (totalizer 1) can be reset to zero at any time while the second (totalizer 2) totalizes the flow from commissioning onwards and cannot be reset.



The totalizers are not available for the "Flow in %" flow type.

8.8.2 Preparatory steps



Before calibrating the Deltabar M, the impulse piping must be cleaned and filled with medium. → See the following table.













	Valves	Meaning	Preferred installation
1	Close 3.		
2	Fill measuring system with medium.		
	Open A, B, 2, 4.	Medium flows in.	
3	Clean impulse piping if necessary ¹⁾ : – by blowing out with compressed air in the case of gases – by rinsing out in the case of liquids.		
	Close 2 and 4.	Block off device.	
	Open 1 and 5. ¹	Blow out/rinse out impulse piping.	
	Close 1 and 5. ¹	Close valves after cleaning.	
4	Vent device.		
	Open 2 and 4.	Introduce medium.	
	Close 4.	Close low-pressure side.	
	Open 3.	Balance positive and low-pressure side.	
	Open 6 and 7 briefly, then close them again.	Fill device completely with medium and remove air.	
5	Carry out position zero adjustment (→ 73) if the following conditions are met. If the conditions are not met, then do not carry out the pos. zero adjustment until after step 6. Conditions: – The process cannot be blocked off. – The tapping points (A and B) are at the same geodetic height.		
6	Set measuring point in operation.		
	Close 3.	Shut off high-pressure side from low-pressure side.	
	Open 4.	Connect low-pressure side.	
	Now – 1 ¹ , 3, 5 ¹ , 6 and 7 are closed. – 2 and 4 are open. – A and B open (if present).		
7	Carry out position zero adjustment (→ 73) if the flow can be blocked off. In this case, step 5 is not applicable.		
8	Carry out calibration. → See page 95, → Chap. 8.8.3.		

Above: preferred installation for gases
Below: preferred installation for liquids

- I Deltabar M
- II Three-valve manifold
- III Separator
- 1, 5 Drain valves
- 2, 4 Inlet valves
- 3 Equalizing valve
- 6, 7 Vent valves on Deltabar M
- A, B Shut-off valves

1) for arrangement with 5 valves

8.8.3 Required parameters for the "Flow" measuring mode

Parameter name	Description
Lin./SQRT switch (133) (Deltabar)	→  119
Measuring mode (005)	→  119
Switch P1/P2 (163)	→  121
High-pressure side (006) (Deltabar)	→  121
Press. eng. unit (125)	→  120
Corrected press. (172)	→  122
Pos. zero adjust (007) (Deltabar M and gauge pressure sensor)	→  120
Max. flow (009)	→  128
Max. pressure flow (010)	→  128
Damping switch (164)	→  120
Damping value (017)	→  120
Flow (018)	→  128
Pressure af. damp (111)	→  122

8.9 Level measurement (Deltabar M)

8.9.1 Preparatory steps

Open container



Before calibrating the device, the impulse piping must be cleaned and filled with medium.
→ See the following table.

	Valves	Meaning	Installation
1	Fill container to a level above the lower tap.		<p style="text-align: right;">A0030038</p>
2	Fill measuring system with medium.		
	Open A.	Open shut-off valve.	
3	Vent device.		
	Open 6 briefly, then close it again.	Fill device completely with medium and remove air.	
4	Set measuring point in operation.		<p><i>Open container</i></p> <p>I Deltabar M</p> <p>II Separator</p> <p>6 Vent valves on Deltabar M</p> <p>A Shut-off valve</p> <p>B Drain valve</p>
	Now - B and 6 are closed. - A is open.		
5	Carry out calibration according to one of the following methods:		
	<ul style="list-style-type: none"> ▪ "In pressure" - with reference pressure (→ 99) ▪ "In pressure" - without reference pressure (→ 101) ▪ "In height" - with reference pressure (→ 103) ▪ "In height" - without reference pressure (→ 105) 		

Closed container



Before calibrating the device, the impulse piping must be cleaned and filled with medium.
 → See the following table.

	Valves	Meaning	Installation
1	Fill container to a level above the lower tap.		
2	Fill measuring system with medium.		
	Close 3.	Shut off high-pressure side from low-pressure side.	
	Open A and B.	Open shut-off valves.	
3	Vent high-pressure side (empty low-pressure side if necessary).		
	Open 2 and 4.	Introduce medium on high-pressure side.	
	Open 6 and 7 briefly, then close them again.	Fill high-pressure side completely with medium and remove air.	
4	Set measuring point in operation.		<p><i>Closed container</i></p> <ul style="list-style-type: none"> I Deltabar M II Three-valve manifold III Separator 1, 5 Drain valves 2, 4 Inlet valves 3 Equalizing valve 6, 7 Vent valve on Deltabar M A, B Shut-off valve
	Now - 3, 6 and 7 are closed. - 2, 4, A and B are open.		
5	Carry out calibration according to one of the following methods:		
	<ul style="list-style-type: none"> ▪ "In pressure" - with reference pressure (→ 99) ▪ "In pressure" - without reference pressure (→ 101) ▪ "In height" - with reference pressure (→ 103) ▪ "In height" - without reference pressure (→ 105) 		

Closed container with superimposed steam



Before calibrating the device, the impulse piping must be cleaned and filled with medium.
 → See the following table.

	Valves	Meaning	Installation
1	Fill container to a level above the lower tap.		
2	Fill measuring system with medium.		
	Open A and B.	Open shut-off valves.	
	Fill the negative impulse piping to the level of the condensate trap.		
3	Vent device.		
	Open 2 and 4.	Introduce medium.	
	Close 4.	Close low-pressure side.	
	Open 3.	Balance positive and low-pressure side.	
	Open 6 and 7 briefly, then close them again.	Fill device completely with medium and remove air.	
4	Set measuring point in operation.		
	Close 3.	Shut off high-pressure side from low-pressure side.	
	Open 4.	Connect low-pressure side.	
	Now - 3, 6 and 7 are closed. - 2, 4, A and B are open.		
5	Carry out calibration according to one of the following methods:		<p><i>Closed container with superimposed steam</i></p> <ul style="list-style-type: none"> I Deltabar M II Three-valve manifold III Separator 1, 5 Drain valves 2, 4 Inlet valves 3 Equalizing valve 6, 7 Vent valves on Deltabar M A, B Shut-off valves
	<ul style="list-style-type: none"> ▪ "In pressure" - with reference pressure (→ 99) ▪ "In pressure" - without reference pressure (→ 101) ▪ "In height" - with reference pressure (→ 103) ▪ "In height" - without reference pressure (→ 105) 		

8.9.2 "In pressure" level selection Calibration with reference pressure (wet calibration)

Example:

In this example, the level in a tank should be measured in "m". The maximum level is 3 m (9.8 ft). The pressure range is due to the filling height and the density.

Prerequisite:

- The measured variable is in direct proportion to the pressure.
- The tank can be filled and emptied.



The values entered for "Empty calib. (028)/Full calib. (031)" and the pressures present at the device must be at least 1% apart. The value will be rejected, and a warning message displayed, if the values are too close together. Further limit values are not checked; i.e. the values entered must be appropriate for the sensor and the measuring task so that the measuring device can measure correctly.

Description	
1	Perform "position adjustment" → 73.
2	Select the "Level" measuring mode via the "Measuring mode (005)" parameter. Menu path: Setup → Measuring mode (005)
3	Select a pressure unit by means of the "Press. eng. unit (125)" parameter, here "mbar" for example. Menu path: Setup → Press. eng. unit (125)
4	Select the "In pressure" level mode by means of the "Level selection (024)" parameter. Menu path: Setup → Extended Setup → Level → Level selection (024)

Description	
5	Select a level unit by means of the "Unit before lin. (025)" parameter, here "m" for example. Menu path: Setup → Extended Setup → Level → Unit before lin. (025)
6	Select the "Wet" option by means of the "Calibration mode (027)" parameter. Menu path: Setup → Extended Setup → Level → Calibration mode (027)
7	The pressure for the lower calibration point is present at the device, here 0 mbar for example. Select the "Empty calib. (028)" parameter. Menu path: Setup → Extended Setup → Level → Empty calib. (028) Enter the level value, here 0 m for example. The pressure value present is assigned to the lower level value by confirming the value.
8	The pressure for the upper calibration point is present at the device, here 300 mbar (4.35 psi) for example. Select the "Full calib. (031)" parameter. Menu path: Setup → Extended Setup → Level → Full calib. (031) Enter the level value, here 3 m (9.8 ft) for example. The pressure value present is assigned to the upper level value by confirming the value.
9	If calibration is performed with a medium other than the process medium, enter the density of the calibration medium in "Adjust density (034)". Menu path: Setup → Extended Setup → Level → Adjust density (034)
10	If calibration was performed with a medium other than the process medium, specify the density of the process medium in the "Process density (035)" parameter. Menu path: Setup → Extended Setup → Level → Process density (035)
11	Result: The measuring range is set for 0 to 3 m (9.8 ft).

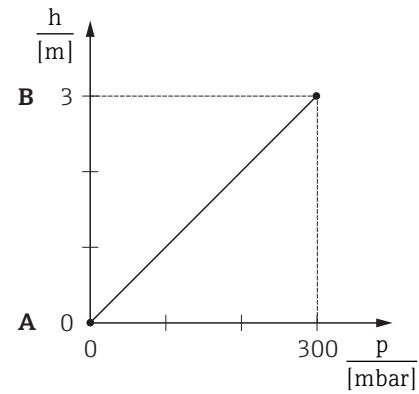

A0017658

Fig. 36: Calibration with reference pressure – wet calibration

A See Table, Step 7.
B See Table, Step 8.



The measured variables %, level, volume and mass are available for this level mode. See → 123 **"Unit before lin. (025)"**.

8.9.3 "In pressure" level selection Calibration without reference pressure (dry calibration)

Example:

In this example, the volume in a tank should be measured in liters. The maximum volume of 1000 liters (264 gal) corresponds to a pressure of 450 mbar (6.53 psi). The minimum volume of 0 liters corresponds to a pressure of 50 mbar (0.72 psi) since the device is mounted below the start of the level measuring range.

Prerequisite:

- The measured variable is in direct proportion to the pressure.
- This is a theoretical calibration i.e. the pressure and volume values for the lower and upper calibration point must be known.



- The values entered for "Empty calib. (028)/Full calib. (031)", "Empty pressure (029)/Full pressure (032)" must be at least 1% apart. The value will be rejected, and a warning message displayed, if the values are too close together. Further limit values are not checked; i.e. the values entered must be appropriate for the sensor and the measuring task so that the measuring device can measure correctly.
- Due to the orientation of the device, there may be pressure shifts in the measured value, i.e. when the container is empty or partly filled, the measured value is not zero. For information on how to perform position adjustment, see → 73, "Pos. zero adjust".

Description	
1	Select the "Level" measuring mode via the "Measuring mode (005)" parameter. Menu path: Setup → Measuring mode (005)
2	Select a pressure unit by means of the "Press. eng. unit (125)" parameter, here "mbar" for example. Menu path: Setup → Press. eng. unit (125)
3	Select the "In pressure" level mode by means of the "Level selection (024)" parameter. Menu path: Setup → Extended Setup → Level → Level selection (024)
4	Select a volume unit by means of the "Unit before lin. (025)" parameter, here "l" (liter) for example. Menu path: Setup → Extended Setup → Level → Unit before lin. (025)

Description	
5	Select the "Dry" option by means of the "Calibration mode (027)" parameter. Menu path: Setup → Extended Setup → Level → Calibration mode (027)
6	"Adjust density (034)" contains the factory setting 1.0, but this value can be changed if required. The entered value pairs must correspond to this density. Menu path: Setup → Extended Setup → Level → Adjust density (034)
7	Enter the volume value for the lower calibration point via the "Empty calib. (028)" parameter, here 0 liters for example. Menu path: Setup → Extended Setup → Level → Empty calib. (028)
8	Enter the pressure value for the lower calibration point via the "Empty pressure (029)" parameter, here 50 mbar (0.72 psi) for example. Menu path: Setup → Extended Setup → Level → Empty pressure (029)
9	Enter the volume value for the upper calibration point via the "Full calib. (031)" parameter, here 1000 liters (264 gal) for example. Menu path: Setup → Extended Setup → Level → Full calib. (031)
10	Enter the pressure value for the upper calibration point via the "Full pressure (032)" parameter, here 450 mbar (6.53 psi) for example. Menu path: Setup → Extended Setup → Level → Full pressure (032)
11	If calibration was performed with a medium other than the process medium, specify the density of the process medium in the "Process density (035)" parameter. Menu path: Setup → Extended Setup → Level → Process density (035)
12	Result: The measuring range is set for 0 to 1000 l (264 gal).

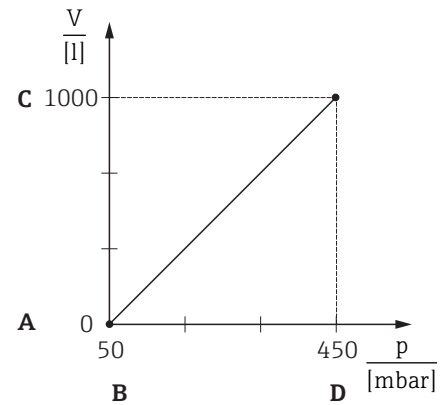

Fig. 37: Calibration with reference pressure – wet calibration

- A See Table, Step 7.
- B See Table, Step 8.
- C See Table, Step 9.
- D See Table, Step 10.

A0031194



The measured variables %, level, volume and mass are available for this level mode.
See → 123 **Unit before lin. (025)**.

8.9.4 "In height" level selection Calibration without reference pressure (dry calibration)

Example:

In this example, the volume in a tank should be measured in liters. The maximum volume of 1000 liters (264 gal) corresponds to a level of 4.5 m (14.8 ft). The minimum volume of 0 liters corresponds to a level of 0.5 m (1.6 ft) since the device is mounted below the start of the level measuring range.

Prerequisite:

- The measured variable is in direct proportion to the pressure.
- This is a theoretical calibration i.e. the height and volume values for the lower and upper calibration point must be known.



- The values entered for "Empty calib. (028)/Full calib. (031)", "Empty height (030)/Full height (033)" must be at least 1% apart. The value will be rejected, and a warning message displayed, if the values are too close together. Further limit values are not checked; i.e. the values entered must be appropriate for the sensor and the measuring task so that the measuring device can measure correctly.
- Due to the orientation of the device, there may be pressure shifts in the measured value, i.e. when the container is empty or partly filled, the measured value is not zero. For information on how to perform position adjustment, see → 73, "Pos. zero adjust".

	Description
1	Select the "Level" measuring mode via the "Measuring mode (005)" parameter. Menu path: Setup → Measuring mode (005)
2	Select a pressure unit via the "Press. eng. unit (125)" parameter, here "mbar" for example. Menu path: Setup → Press. eng. unit (125)
3	Select the "In height" level mode via the "Level selection (024)" parameter. Menu path: Setup → Extended Setup → Level → Level selection (024)
4	Select a volume unit via the "Unit before lin. (025)" parameter, here "l" (liter) for example. Menu path: Setup → Extended Setup → Level → Unit before lin. (025)
5	Select a level unit by means of the "Height unit (026)" parameter, here "m" for example. Menu path: Setup → Extended Setup → Level → Height unit (026)
6	Select the "Dry" option by means of the "Calibration mode (027)" parameter. Menu path: Setup → Extended Setup → Level → Calibration mode (027)
7	Enter the density of the medium via the "Adjust density (034)" parameter, here "1 g/cm ³ " (1 SGU) for example. Menu path: Setup → Extended Setup → Level → Adjust density (034)

Description	
8	<p>Enter the volume value for the lower calibration point via the "Empty calib. (028)" parameter, here 0 liters for example.</p> <p>Menu path: Setup → Extended Setup → Level → Empty calib. (028)</p>
9	<p>Enter the height value for the lower calibration point via the "Empty height (030)" parameter, here 0.5 m (1.6 ft) for example.</p> <p>Menu path: Setup → Extended Setup → Level → Empty height (030)</p>
10	<p>Enter the volume value for the upper calibration point via the "Full calib. (031)" parameter, here 1000 liters (264 gal) for example.</p> <p>Menu path: Setup → Extended Setup → Level → Full calib. (031)</p>
11	<p>Enter the height value for the upper calibration point via the "Full height (033)" parameter, here 4.5 m (14.8 ft) for example.</p> <p>Menu path: Setup → Extended Setup → Level → Full height (033)</p>
12	<p>If the process uses a medium other than that on which the calibration was based, the new density must be specified in the "Process density (035)" parameter.</p> <p>Menu path: Setup → Extended Setup → Level → Process density (035)</p>
13	<p>Result: The measuring range is set for 0 to 1000 l (264 gal).</p>

A See Table, Step 7.
B See Table, Step 8.
C See Table, Step 9.
D See Table, Step 10.
E See Table, Step 11.

A0031195



The measured variables %, level, volume and mass are available for this level mode → 123 "Unit before lin. (025)".

8.9.5 "In height" level selection Calibration with reference pressure (wet calibration)

Example:

In this example, the volume in a tank should be measured in liters. The maximum volume of 1000 liters (264 gal) corresponds to a level of 4.5 m (14.8 ft). The minimum volume of 0 liters corresponds to a level of 0.5 m (1.6 ft) since the device is mounted below the start of the level measuring range.

The density of the medium is 1 g/cm³ (1 SGU).

Prerequisite:

- The measured variable is in direct proportion to the pressure.
- The tank can be filled and emptied.



The values entered for "Empty calib. (028)/Full calib. (031)" and the pressure values present at the device must be at least 1% apart. The value will be rejected, and a warning message displayed, if the values are too close together. Further limit values are not checked; i.e. the values entered must be appropriate for the sensor and the measuring task so that the measuring device can measure correctly.

Description	
1	Perform position adjustment. See → 73.
2	Select the "In height" level mode via the "Level selection (024)" parameter. Menu path: Setup → Extended Setup → Level → Level selection (024)
3	Select the "Level" measuring mode via the "Measuring mode (005)" parameter. Menu path: Setup → Measuring mode (005)
4	Select a pressure unit via the "Press. eng. unit (125)" parameter, here "mbar" for example. Menu path: Setup → Press. eng. unit (125)
5	Select a volume unit via the "Unit before lin. (025)" parameter, here "l" (liter) for example. Menu path: Setup → Extended Setup → Level → Unit before lin. (025)

Description	
6	Select a level unit by means of the "Height unit (026)" parameter, here "m" for example. Menu path: Setup → Extended Setup → Level → Height unit (026)
7	Select the "Wet" option by means of the "Calibration mode (027)" parameter. Menu path: Setup → Extended Setup → Level → Calibration mode (027)
8	If calibration is performed with a medium other than the process medium, enter the density of the calibration medium in the "Adjust density (034)" parameter, here 1 g/cm ³ (1 SGU) for example. Menu path: Setup → Extended Setup → Level → Adjust density (034)
9	The pressure for the lower calibration point is present at the device, here 0.5 m covered / 49 mbar (0.71 psi) for example. Enter the volume value for the lower calibration point via the "Empty calib. (028)" parameter, here 0 liters for example. (The pressure currently measured is displayed as the height, here 0.5 m (1.6 ft) for example.) Menu path: Setup → Extended Setup → Level → Empty calib. (028)
10	The pressure for the upper calibration point is present at the device, here 4.5 m covered / 441 mbar (6.4 psi) for example. Enter the volume value for the upper calibration point via the "Full calib. (031)" parameter, here "1000 liters" (264 gal) for example. The pressure currently measured is displayed as the height, here "4.5 m" (14.8 ft) for example. Menu path: Setup → Extended Setup → Level → Full calib. (031)
11	If calibration was performed with a medium other than the process medium, specify the density of the process medium in the "Process density (035)" parameter. Menu path: Setup → Extended Setup → Level → Process density (035)
12	Result: The measuring range is set for 0 to 1000 l (264 gal).

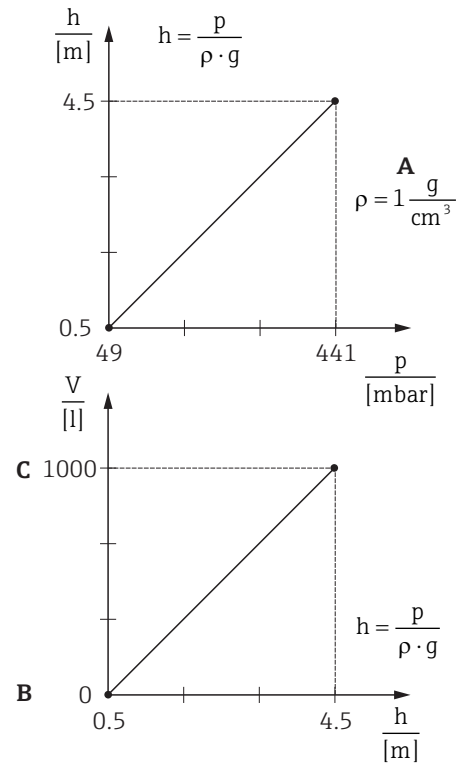















Fig. 39: Calibration with reference pressure - wet calibration

- A See Table, Step 8.
- B See Table, Step 9.
- C See Table, Step 10.



The measured variables %, level, volume and mass are available for this level mode → 123 "Unit before lin. (025)".

8.9.6 Required parameters for Level measuring mode

Parameter name	Description
Level selection (024)	→  123
Unit before lin. (025)	→  123
Height unit (026)	→  123
Calibration mode (027)	→  123
Empty calib. (028)	→  124
Empty pressure (029) <i>Empty pressure (185)</i>	→  124
Empty height (030) <i>Empty height (186)</i>	→  124
Full calib. (031)	→  124
Full pressure (187) <i>Full pressure (032)</i>	→  124
Full height (033) <i>Full height (188)</i>	→  124
Density unit (127)	→  125
Adjust density (034)	→  125
Process density (035)	→  125
Level before lin. (019)	→  125

8.10 Overview of the onsite display operating menu

All parameters and their direct access code (in brackets) are listed in the following table. The page number refers to where a description of the parameter can be found.

Level 1	Level 2	Level 3	Level 4	Page
Parameters in italics are read-only parameters and cannot be edited. Specific settings, such as the measuring mode, dry or wet calibration, or hardware locking, determine whether these parameters are displayed.				
Language (000)				→ 117
Display/operat.	Display mode (001)			→ 117
	Add. disp. value (002)			→ 117
	Format 1st value (004)			→ 118
	FF input source (233)			→ 118
	FF input unit (234)			→ 118
	FF input form (235)			→ 118
Setup	Lin./SQRT switch (133) (Deltabar)			→ 119
	Measuring mode (005) <i>Measuring mode (182)</i>			→ 119
	Switch P1/P2 (163)			→ 121
	High-pressure side (006) (Deltabar) <i>High-pressure side (183) (Deltabar)</i>			→ 121
	Press. eng. unit (125)			→ 120
	Corrected press. (172)			→ 122
	Pos. zero adjust (007) (Deltabar M and gauge pressure sensor) Calib. offset (192) / (008) (absolute pressure sensor) (absolute pressure sensors)			→ 120 → 120
	Max. flow (009) ("Flow" measuring mode) (Deltabar)			→ 128
	Max. pressure flow (010) ("Flow" measuring mode) (Deltabar)			→ 128
	Empty calib. (028) ("Level" measuring mode and "Calibration mode (027)" = wet)			→ 124
	Full calib. (031) ("Level" measuring mode and "Calibration mode (027)" = wet)			→ 124
	Damping switch (164) (read only)			→ 120
	Damping value (017) <i>Damping value (184)</i>			→ 120
	Flow (018) ("Flow" measuring mode) (Deltabar)			→ 128
	Level before lin. (019) ("Level" measuring mode)			→ 125
	Pressure af. damp (111)			→ 122
	Extended setup		Code definition (023)	→ 116
			Pd-tag. (022)	→ 117
			Operator code (021)	→ 116
	Level (Level measuring mode)		Level selection (024)	→ 123
		Unit before lin. (025)	→ 123	
		Height unit (026)	→ 123	
		Calibration mode (027)	→ 123	
		Empty calib. (028)	→ 124	
		Empty pressure (029) <i>Empty pressure (185)</i>	→ 124	
		Empty height (030) <i>Empty height (186)</i>	→ 124	
		Full calib. (031)	→ 124	
...		

Level 1	Level 2	Level 3	Level 4	Page
... Setup	... Extended setup	... Level (Level measuring mode)	Full pressure (032) <i>Full pressure (187)</i>	→ 124
			Full height (033) <i>Full height (188)</i>	→ 124
			Adjust density (034)	→ 125
			Process density (035)	→ 125
			Level before lin. (019)	→ 125
		Linearization	Lin. mode (037)	→ 125
			Unit after lin. (038)	→ 126
			Line numb. (039)	→ 126
			X-value (040) (manual entry) <i>X-value (123) (in linear/activ table)</i>	→ 126
			Y-value (041) (manual entry/in semi-auto. entry) <i>Y-value (194) (in linear/activ table)</i>	→ 126
			Edit table (042)	→ 126
			Tank description (173)	→ 126
			Tank content (043)	→ 126
		Flow ("Flow" measuring mode) (Deltabar M)	Flow type (044)	→ 127
			Mass flow unit (045)	→ 127
			Norm. flow unit (046)	→ 127
			Std. flow unit (047)	→ 127
			Flow unit (048)	→ 128
			Max. flow (009)	→ 128
			Max. pressure flow (010)	→ 128
			Set low-flow cut-off (049)	→ 128
			Flow (018)	→ 128
		Analog Input 1	Channel/CHANNEL (171)	→ 130
			Out value (195)	→ 130
			Out status (196)	→ 130
		Analog Input 2	Channel/CHANNEL (200)	→ 130
			Out value (201)	→ 130
			Out status (202)	→ 130
		Analog Input 3 (if instantiated)	Channel/CHANNEL (238)	→ 130
			Out value (239)	→ 130
			Out status (240)	→ 130
		Analog Input 4 (if instantiated)	Channel/CHANNEL (241)	→ 130
			Out value (242)	→ 130
			Out status (243)	→ 130
		Analog Input 5 (Deltabar M) (if instantiated)	Channel/CHANNEL (255)	→ 130
			Out value (256)	→ 130
			Out status (257)	→ 130
		Totalizer 1 (Deltabar M)	Eng. unit totalizer 1 (058) (059) (060) (061)	→ 132
			Totalizer 1 mode (175)	→ 132

Level 1	Level 2	Level 3	Level 4	Page	
...	Totalizer 1 failsafe (176)	→ 132	
... Setup	... Extended setup	... Totalizer 1 (Deltabar M)	Reset Totalizer 1 (062)	→ 132	
			Totalizer 1 (063)	→ 132	
			Totalizer 1 overflow (064)	→ 132	
		Totalizer 2 (Deltabar M)	Eng. unit totalizer 2 (065) (066) (067) (068)	→ 133	
			Totalizer 2 mode (177)	→ 133	
			Totalizer 2 failsafe (178)	→ 133	
			Totalizer 2 (069)	→ 133	
			Totalizer 2 overflow (070)	→ 133	
Diagnosis	Diagnostic code (071)			→ 133	
	Last diag. code (072)			→ 133	
	Min. meas. press. (073)			→ 134	
	Max. meas. press. (074)			→ 134	
	Diagnostic list	Diagnostic 1 (075)			→ 134
		Diagnostic 2 (076)			→ 134
		Diagnostic 3 (077)			→ 134
		Diagnostic 4 (078)			→ 134
		Diagnostic 5 (079)			→ 134
		Diagnostic 6 (080)			→ 134
		Diagnostic 7 (081)			→ 134
		Diagnostic 8 (082)			→ 134
		Diagnostic 9 (083)			→ 134
		Diagnostic 10 (084)			→ 134
	Event logbook	Last diag. 1 (085)			→ 135
		Last diag. 2 (086)			→ 135
		Last diag. 3 (087)			→ 135
		Last diag. 4 (088)			→ 135
		Last diag. 5 (089)			→ 135
		Last diag. 6 (090)			→ 135
		Last diag. 7 (091)			→ 135
		Last diag. 8 (092)			→ 135
		Last diag. 9 (093)			→ 135
		Last diag. 10 (094)			→ 135
	Instrument info	Firmware version (095)			→ 117
		Serial number (096)			→ 117
		Ext. order code (097)			→ 117
		Order code (098)			→ 117
		Pd-tag. (022)			→ 117
		ENP version (099)			→ 117
Config. counter (100)			→ 134		
LRL sensor (101)			→ 128		
URL sensor (102)			→ 128		
Device type code (236)			→ 129		

Level 1	Level 2	Level 3	Level 4	Page	
...	...	Device revision (237)		→ 129	
... Diagnosis	Measured values	Flow (018)		→ 128	
		Level before lin. (019)		→ 125	
		Tank content (043)		→ 126	
		Meas. pressure (020)		→ 121	
		Sensor pressure (109)		→ 122	
		Corrected press. (172)		→ 122	
		Pressure af. damp (111)		→ 122	
		Sensor temp. (110) (only for Cerabar M and Deltapilot M)		→ 121	
		Analog Input 1	Channel/CHANNEL (171)		→ 130
			Out value (195)		→ 130
			Out status (196)		→ 130
		Analog Input 2	Channel/CHANNEL (200)		→ 130
			Out value (201)		→ 130
			Out status (202)		→ 130
		Analog Input 3 (if instantiated)	Channel/CHANNEL (238)		→ 130
			Out value (239)		→ 130
			Out status (240)		→ 130
	Analog Input 4 (if instantiated)	Channel/CHANNEL (241)		→ 130	
		Out value (242)		→ 130	
		Out status (243)		→ 130	
	Analog Input 5 (Deltabar M) (if instantiated)	Channel/CHANNEL (255)		→ 130	
		Out value (256)		→ 130	
		Out status (257)		→ 130	
	Simulation	Totalizer 1 (Deltabar M)	Totalizer 1 (063)		→ 132
			Totalizer 1 overflow (064)		→ 132
		Totalizer 2 (Deltabar M)	Totalizer 2 (069)		→ 133
			Totalizer 2 overflow (070)		→ 133
			Sim. pressure (113)		→ 136
			Sim. flow (114) (Deltabar M)		→ 136
			Sim. level (115)		→ 136
			Sim. tank cont. (116)		→ 136
			Sim. error no. (118)		→ 136
		Simul. switch (251)		→ 135	
Simulation mode (112)			→ 135		
Sim. pressure (113)			→ 136		
Sim. flow (114) (Deltabar M)			→ 136		
Sim. level (115)			→ 136		
Sim. tank cont. (116)			→ 136		
Sim. error no. (118)			→ 136		
	Reset	Enter reset code (124)		→ 118	
Expert	Direct access (119)			→ 116	
...	System	Code definition (023)		→ 116	

Level 1	Level 2	Level 3	Level 4	Page	
... Expert	... System	Lock switch (120)		→ 116	
		Operator code (021)		→ 116	
		Instrument info	Pd-tag. (022) Pd-tag. (022)	→ 117	
		... Instrument info	Serial number (096)		→ 117
			Firmware version (095)		→ 117
			Ext. order code (097)		→ 117
			Order code (098)		→ 117
			ENP version (099)		→ 117
			Electr. serial no. (121)		→ 117
			Sensor serial no. (122)		→ 117
		Display	Language (000)		→ 117
			Display mode (001)		→ 117
			Add. disp. value (002)		→ 117
			Format 1st value (004)		→ 118
			FF input source (233)		→ 118
			FF input unit (234)		→ 118
			FF input form (235)		→ 118
	Management	Enter reset code (124)		→ 118	
		Download select		→ 119	
	Measurement	Lin./SQRT switch (133) (Deltabar)		→ 119	
		Measuring mode (005) <i>Measuring mode (182)</i>		→ 119	
		Basic setup	Pos. zero adjust (007) (Deltabar M and gauge pressure sensor)		→ 120
			Calib. offset (192) / (008) (absolute pressure sensor)		→ 120
			Damping switch (164)		→ 120
			Damping value (017) <i>Damping value (184)</i>		→ 120
			Press. eng. unit (125)		→ 120
			Temp. eng. unit (126) (only for Cerabar M and Deltapilot M)		→ 121
			Sensor temp. (110)		→ 121
		Pressure	Switch P1/P2 (163)		→ 121
			High-pressure side (006) (Deltabar) <i>High-pressure side (183) (Deltabar)</i>		→ 121
			Meas. pressure (020)		→ 121
			Sensor pressure (109)		→ 122
			Corrected press. (172)		→ 122
Pressure af. damp (111)			→ 122		
Level			Level selection (024)		→ 123
		Unit before lin. (025)		→ 123	
		Height unit (026)		→ 123	
		Calibration mode (027)		→ 123	
		Empty calib. (028)		→ 124	
...	

Level 1	Level 2	Level 3	Level 4	Page	
... Expert	... Measurement	... Level	Empty pressure (029) <i>Empty pressure (185)</i>	→ 124	
			Empty height (030) <i>Empty height (186)</i>	→ 124	
			Full calib. (031)	→ 124	
			Full pressure (032) <i>Full pressure (187)</i>	→ 124	
			Full height (033) <i>Full height (188)</i>	→ 124	
			Density unit (127)	→ 83	
			Adjust density (034)	→ 125	
			Process density (035)	→ 125	
			Level before lin. (019)	→ 125	
			Linearization	Lin. mode (037)	→ 125
			Unit after lin. (038)	→ 126	
			Line numb. (039)	→ 126	
			X-value (040) (manual entry) <i>X-value (123) (in linear/activ table)</i>	→ 126	
			Y-value (041) (manual entry/in semi-auto. entry) <i>Y-value (194) (in linear/activ table)</i>	→ 126	
			Edit table (042)	→ 126	
			Tank description (173)	→ 126	
			Tank content (043)	→ 126	
			Flow (Deltabar M)	Flow type (044)	→ 127
				Mass flow unit (045)	→ 127
				Norm. flow unit (046)	→ 127
				Std. flow unit (047)	→ 127
				Flow unit (048)	→ 128
				Max. flow (009)	→ 128
				Max. pressure flow (010)	→ 128
				Set low-flow cut-off (049)	→ 128
				Flow (018)	→ 128
			Sensor limits	LRL sensor (101)	→ 128
				URL sensor (102)	→ 128
			Sensor trim	Lo trim measured (129)	→ 129
				Hi trim measured (130)	→ 129
				Lo trim sensor (131)	→ 129
				Hi trim sensor (132)	→ 129
		Communication	FF info	Device type code (236)	→ 129
				Device revision (237)	→ 129
				Device address (244)	→ 129
				Device class (245)	→ 129
		Analog Input 1		Channel/CHANNEL (171)	→ 130
				Out value (195)	→ 130
				Out status (196)	→ 130
			

Level 1	Level 2	Level 3	Level 4	Page		
... Expert	... Communication	Analog Input 2	Channel/CHANNEL (200)	→ 130		
			Out value (201)	→ 130		
			Out status (202)	→ 130		
		Analog Input 3 (if instantiated)	Channel/CHANNEL (238)	→ 130		
			Out value (239)	→ 130		
			Out status (240)	→ 130		
		Analog Input 4 (if instantiated)	Channel/CHANNEL (241)	→ 130		
			Out value (242)	→ 130		
			Out status (243)	→ 130		
		Analog Input 5 (Deltabar M) (if instantiated)	Channel/CHANNEL (255)	→ 130		
			Out value (256)	→ 130		
			Out status (257)	→ 130		
		Application	Electr. delta P (158)			→ 131
				Fixed ext. value (174)		→ 131
				E.Delta p selec. (246)		→ 131
	E.Delta p value (247)				→ 131	
	E.Delta p status (248)				→ 131	
	E.Delta p unit (249)				→ 131	
	Totalizer 1 (Deltabar M)		Eng. unit totalizer 1 (058) (059) (060) (061)	Totalizer 1 mode (175)		→ 132
				Totalizer 1 failsafe (176)		→ 132
				Reset Totalizer 1 (062)		→ 132
				Totalizer 1 (063)		→ 132
				Totalizer 1 overflow (064)		→ 132
				Totalizer 2 (Deltabar M)	Eng. unit totalizer 2 (065) (066) (067) (068)	Totalizer 2 mode (177)
	Totalizer 2 failsafe (178)					→ 133
	Totalizer 2 (069)					→ 133
	Totalizer 2 overflow (070)					→ 133
	Diagnosis		Diagnostic code			
			Last diag. code (072)			→ 133
			Reset logbook (159)			→ 134
			Min. meas. press. (073)			→ 134
			Max. meas. press. (074)			→ 134
			Reset peakhold (161)			→ 134
Alarm behav. P (050)				→ 134		
Operating hours (162)				→ 134		
Config. counter (100)				→ 134		
Diagnostic list		Diagnostic 1 (075)	Diagnostic 1 (075)		→ 134	
			Diagnostic 2 (076)		→ 134	
			Diagnostic 3 (077)		→ 134	
			Diagnostic 4 (078)		→ 134	
			Diagnostic 5 (079)		→ 134	
...				

Level 1	Level 2	Level 3	Level 4	Page
... Expert	... Diagnosis	... Diagnostic list	Diagnostic 6 (080)	→ 134
			Diagnostic 7 (081)	→ 134
			Diagnostic 8 (082)	→ 134
			Diagnostic 9 (083)	→ 134
			Diagnostic 10 (084)	→ 134
		Event logbook	Last diag. 1 (085)	→ 135
			Last diag. 2 (086)	→ 135
			Last diag. 3 (087)	→ 135
			Last diag. 4 (088)	→ 135
			Last diag. 5 (089)	→ 135
			Last diag. 6 (090)	→ 135
			Last diag. 7 (091)	→ 135
			Last diag. 8 (092)	→ 135
			Last diag. 9 (093)	→ 135
			Last diag. 10 (094)	→ 135
		Simulation	Simul. switch	→ 135
			Simulation mode	→ 135
			Sim. pressure	→ 136
			Sim. flow (Deltabar M)	→ 136
			Sim. level	→ 136
			Sim. tank cont.	→ 136
			Sim. error no.	→ 136

8.11 Description of parameters



This section describes the parameters in the order they are arranged in the "Expert" operating menu.

Expert

Parameter name	Description
Direct access (119) Entry	Enter the direct access code to go directly to a parameter. Options: <ul style="list-style-type: none"> ▪ A number between 0 and 999 (only valid entries are recognized) Factory setting: 0 Note: For direct access, it is not necessary to enter leading zeros.

8.11.1 System

Expert → System

Parameter name	Description
Code definition (023) Entry	Use this function to enter a release code with which the device can be unlocked. Options: <ul style="list-style-type: none"> ▪ A number between 0 and 9999 Factory setting: 0
Lock switch (120) Display	Displays the status of DIP switch 1 on the electronic insert. You can lock or unlock parameters relevant to the measured value with DIP switch 1. If operation is locked by means of the " Operator code (021) " parameter, you can only unlock operation again by means of this parameter. Display: <ul style="list-style-type: none"> ▪ On (locking switched on) ▪ Off (locking switched off) Factory setting: Off (locking switched off)
Operator code (021) Entry	Use this function to enter a code to lock or unlock operation. Options: <ul style="list-style-type: none"> ▪ To lock: Enter a number ≠ the release code. ▪ To unlock: Enter the release code.  The release code is "0" in the order configuration. Another release code can be defined in the " Code definition (023) " parameter. If the user has forgotten the release code, it can be made visible again by entering the number sequence "5864". Factory setting: 0

Expert → System → Instrument info

Parameter name	Description
Pd-tag. (022) Display	Physical device tag Example: Deltabar M: EH_Deltabar_M_5x_6B032A0109D
Serial number (096) Display	Displays the serial number of the device (11 alphanumeric characters).
Firmware version (095) Display	Displays the firmware version.
Ext. order code (097) Display	Displays the extended order code (max. 60 alphanumeric characters). Factory setting As per order specifications
Order code (098) Display	Displays the order code (max. 20 alphanumeric characters). Factory setting As per order specifications
ENP version (099) Display	Displays the ENP version (ENP = electronic nameplate)
Electr. serial no. (121) Display	Displays the serial number of the main electronics (11 alphanumeric characters).
Sensor serial no. (122) Display	Displays the serial number of the sensor (11 alphanumeric characters).

Expert → System → Display

Parameter name	Description
Language (000) Options	Select the menu language for the onsite display. Options: <ul style="list-style-type: none"> ▪ English ▪ Possibly another language (as selected when ordering the device) ▪ One further language (language of the manufacturing plant) Factory setting: English
Display mode (001) Options	Specify the contents for the first line of the onsite display in the measuring mode. Options: <ul style="list-style-type: none"> ▪ Only primary value (value+bar graph) ▪ External value only (value+status) ▪ All alternating (primary value+secondary value+ext.value) Factory setting: Primary value (PV)
Add. disp. value (002) Options	Specify the contents for the second line of the onsite display in the measuring mode. Options: <ul style="list-style-type: none"> ▪ No value ▪ Pressure ▪ Main value (%) ▪ Totalizer 1 (Deltabar M) ▪ Totalizer 2 (Deltabar M) The options depend on the measuring mode chosen. Factory setting: No value

Parameter name	Description
Format 1st value (004) Options	Specify the number of places after the decimal point for the value displayed in the main line. Options: <ul style="list-style-type: none"> ▪ Auto ▪ x ▪ x.x ▪ x.xx ▪ x.xxx ▪ x.xxxx ▪ x.xxxxx Factory setting: Auto
FF input source (233) Options	Select which input of the Input Selector Block will appear as an external value on the display (see " Display mode (001) " parameter). Options: <ul style="list-style-type: none"> ▪ Input1 ▪ Input2 ▪ Input3 ▪ Input4 This list corresponds to the inputs of the Input Selector Block. The Block is always instantiated but does not have to be in the Auto mode. Factory setting: Input1
FF input unit (234) Options	Select the unit of the external value. If a new pressure unit is selected, all pressure-specific parameters are converted and displayed with the new unit. Options: <ul style="list-style-type: none"> ▪ mbar, bar ▪ mmH2O, mH2O, ▪ inH2O, ftH2O ▪ Pa, kPa, MPa ▪ psi ▪ mmHg, inHg ▪ kgf/cm² Factory setting: mbar or bar depending on the sensor nominal measuring range, or as per order specifications
FF input form (235) Options	Select the formatting of the external value. Factory setting: x.x

Expert → System → Management

Parameter name	Description
Enter reset code (124) Entry	Reset parameters completely or partially to the factory values or order configuration, →  55, "Resetting to factory settings (reset)". Factory setting: 0

Parameter name	Description
Download select Display	<p>Selection of data records for the Upload/Download function in Fieldcare.</p> <p>Prerequisite: DIP switch 1, 3, 4 and 5 set to "OFF", DIP switch 2 set to "ON" (see picture in Chap. 6.2.1)). A download with the factory setting "Copy configuration" causes all parameters needed for a measurement to be downloaded. If the "Copy configuration" setting is changed, it takes effect only when a corresponding release code is entered into the parameter "Operator code/S_W_LOCK".</p> <p>Options:</p> <ul style="list-style-type: none"> ▪ Copy configuration: With this option, general configuration parameters are overwritten except for serial number, order number, calibration, position adjustment, application, and tag information. ▪ Device replacement: With this option, general configuration parameters are overwritten except for serial number, order number, calibration and position adjustment. ▪ Electronics replacement: This option contains all parameters from "Configuration copy" and "Device replacement" and: "position adjustment", "sensor trimm", "serial number", "order number". <p></p> <p>The control strategy is not affected by a download. Selection of device replacement or electronics replacement takes effect only if a corresponding release code has been entered beforehand.</p> <p>Factory setting: Copy configuration</p>

8.11.2 Measurement

Expert → Measurement



Parameter name	Description
Lin./SQRT switch (133) (Deltabar) Display	<p>Displays the status of DIP switch 4 on the electronic insert, which is used to define the output characteristics of the device.</p> <p>Display:</p> <ul style="list-style-type: none"> ▪ SW setting ▪ Square root The square root signal is used. <p>Factory setting SW setting</p>
Measuring mode (005) Measuring mode (182) Options	<p>Select the measuring mode. The operating menu is structured differently depending on the measuring mode selected.</p> <p></p> <p>If the measuring mode is changed, no conversion takes place. If necessary, the device has to be recalibrated after the measuring mode has been changed.</p> <p>Options:</p> <ul style="list-style-type: none"> ▪ Pressure ▪ Level ▪ Flow (Deltabar M only) <p>Factory setting Pressure or as per order specifications</p>

Expert → Measurement → Basic setup

Parameter name	Description
Pos. zero adjust (007) (Deltabar M and gauge pressure sensor) Options	Position adjustment – the pressure difference between zero (set point) and the measured pressure need not be known. Example: – Measured value = 2.2 mbar (0.032 psi) – You correct the measured value via the "Pos. zero adjust (007)" parameter with the "Confirm" option. This means that you are assigning the value 0.0 to the pressure present. – Measured value (after pos. zero adjust) = 0.0 mbar Options <ul style="list-style-type: none"> ▪ Confirm ▪ Abort Factory setting: Abort
Calib. offset (192) / (008) (absolute pressure sensor) Options	Position adjustment – the pressure difference between the set point and the measured pressure must be known. Example: – Measured value = 982.2 mbar (14.25 psi) – You correct the measured value with the value entered (e.g. 2.2 mbar (0.032 psi)) via the "Calib. offset (192)" parameter. This means that you are assigning the value 980.0 (14.21 psi) to the pressure present. – Measured value (after pos. zero adjust) = 980.0 mbar (14.21 psi) Factory setting: 0.0
Damping switch (164) Display	Displays the switch position of DIP switch 2 which is used to switch the damping of the output signal on and off. Display: <ul style="list-style-type: none"> ▪ Off The output signal is not damped. ▪ On The output signal is damped. The attenuation constant is specified in the "Damping value (017)" parameter Factory setting On
Damping value (017) Damping value (184) Entry	Enter damping time (time constant τ). The damping affects the speed at which the measured value reacts to changes in pressure. Input range: 0.0 to 999.0 s Factory setting: 2.0 or as per order specifications
Press. eng. unit (125) Options	Select the pressure unit. If a new pressure unit is selected, all pressure-specific parameters are converted and displayed with the new unit. Options: <ul style="list-style-type: none"> ▪ mbar, bar ▪ mmH₂O, mH₂O, ▪ inH₂O, ftH₂O ▪ Pa, kPa, MPa ▪ psi ▪ mmHg, inHg ▪ kgf/cm² Factory setting: mbar or bar depending on the sensor nominal measuring range, or as per order specifications

Parameter name	Description
Temp. eng. unit (126) (only for Cerabar M and Deltapilot M) Options	Select the unit for the temperature measured values.  The setting affects the unit for the "Sensor temp. (110)" parameter. Options: <ul style="list-style-type: none"> ▪ °C ▪ °F ▪ K Factory setting: °C
Sensor temp. (110) (only for Cerabar M and Deltapilot M) Display	Displays the temperature currently measured in the sensor. This can deviate from the process temperature.

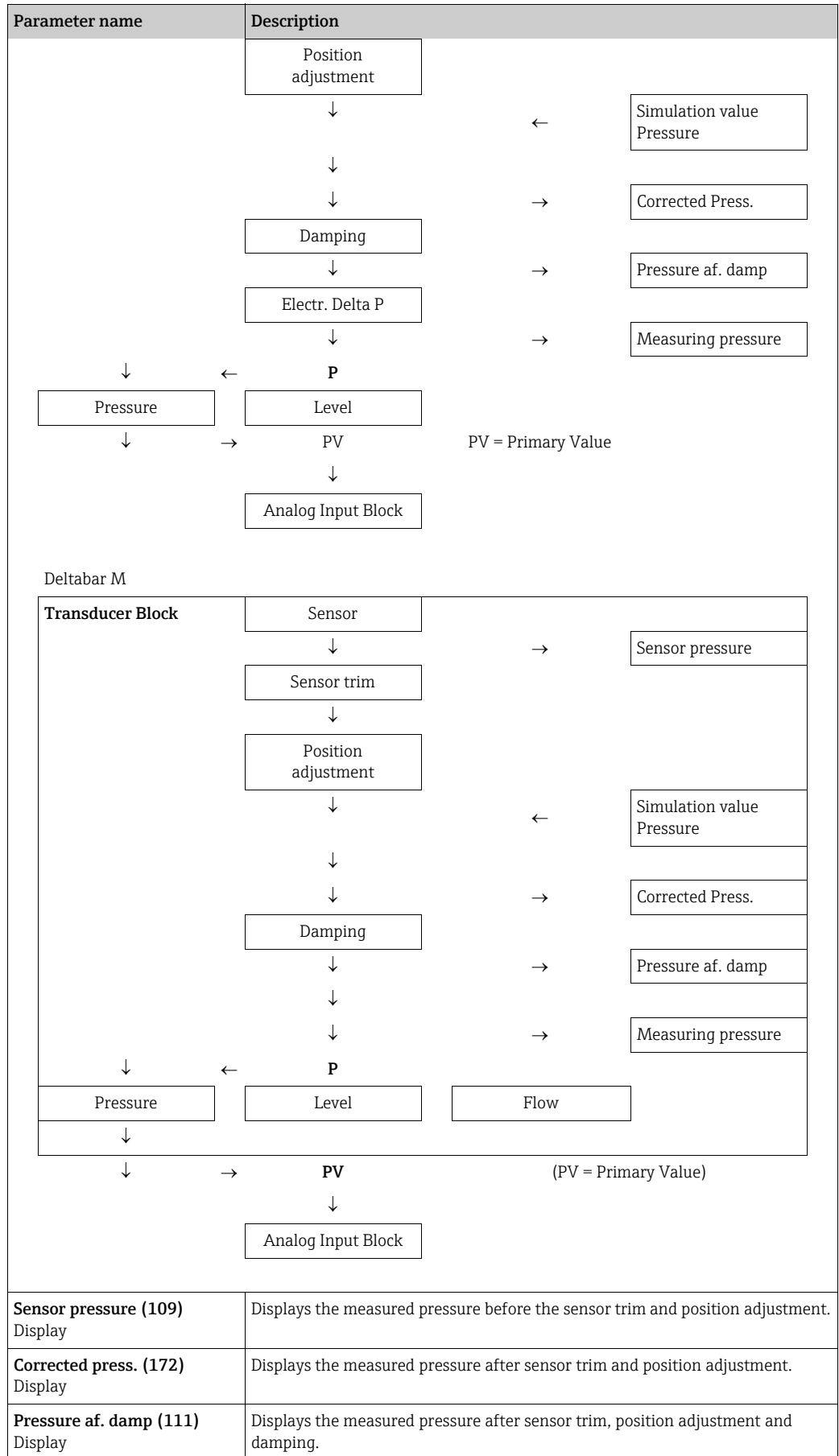

Expert → Measurement → Pressure

Parameter name	Description
Switch P1/P2 (163) Display	Indicates whether the "SW/P2 High" DIP switch (DIP switch 5) is switched on.  The "SW/P2 High" DIP switch determines which pressure input corresponds to the high-pressure side. Display: <ul style="list-style-type: none"> ▪ SW setting "SW/P2 High" is switched off: The "High-pressure side (006) (Deltabar)" parameter determines which pressure input corresponds to the high-pressure side. ▪ P2 High "SW/P2 High" is switched on: Pressure input P2 corresponds to the high-pressure side, independent of the setting in the "High-pressure side (006) (Deltabar)" parameter. Factory setting: SW setting
High-pressure side (006) (Deltabar) High-pressure side (183) (Deltabar) Options	Determines, which pressure input corresponds to the high-pressure side.  This setting is only valid if the "SW/P2 High" DIP switch is in the OFF position (see "Switch P1/P2 (163)" parameter). Otherwise P2 corresponds to the high-pressure side in any case. Options: <ul style="list-style-type: none"> ▪ P1 High Pressure input P1 is the high-pressure side. ▪ P2 High Pressure input P2 is the high-pressure side. Factory setting P1 High
Meas. pressure (020) Display Cerabar M / Deltapilot M	Displays the measured pressure after sensor trim, position adjustment and damping.  <pre> graph TD A[Sensor] --> B[Sensor trim] B --> C[Sensor pressure] </pre>



Expert → Measurement → Level



Parameter name	Description
Level selection (024) Options	Select the method for calculating the level Options: <ul style="list-style-type: none"> ■ In pressure If this option is selected, specify two pressure/level value pairs. The level value is displayed directly in the unit that you select via the "Unit before lin. (025)" parameter. ■ In height If this option is selected, specify two height/level value pairs. From the measured pressure, the device first calculates the height using the density. This information is then used to calculate the level in the "Unit before lin. (025)" selected using the two value pairs specified. Factory setting: In pressure
Unit before lin. (025) Options	Select the unit for the measured value display for the level before linearization.  The unit selected is only used to describe the measured value. This means that the measured value is not converted when a new output unit is selected. Example: <ul style="list-style-type: none"> ■ Current measured value: 0.3 ft ■ New output unit: m ■ New measured value: 0.3 m Options <ul style="list-style-type: none"> ■ % ■ mm, cm, dm, m ■ ft, in ■ m³, in³ ■ l, hl ■ ft³ ■ gal, lgal ■ kg, t ■ lb Factory setting: %
Height unit (026) Options	Select the height unit. The measured pressure is converted to the selected height unit using the "Adjust density (034)" parameter. Prerequisite "Level selection" = "In height" Options <ul style="list-style-type: none"> ■ mm ■ m ■ in ■ ft Factory setting: m
Calibration mode (027) Options	Select the calibration mode. Options: <ul style="list-style-type: none"> ■ Wet Wet calibration takes place by filling and emptying the container. In the case of two different levels, the level, volume, mass or percentage value entered is assigned to the pressure measured at this point in time ("Empty calib. (028)" and "Full calib. (031)" parameters). ■ Dry Dry calibration is a theoretical calibration. For this calibration, you specify two pressure/level value pairs or height/level value pairs via the following parameters: "Empty calib. (028)", "Empty pressure (029)", "Full calib. (031)", "Full pressure (032)", "Empty height (030)", "Full height (033)". Factory setting: Wet

Parameter name	Description
Empty calib. (028) Empty calib. (011) Entry	Enter the output value for the lower calibration point (container empty). The unit defined in "Unit before lin. (025)" must be used.  <ul style="list-style-type: none"> ▪ In the case of wet calibration, the level (container empty) must actually be available. The associated pressure is then automatically recorded by the device. ▪ In the case of dry calibration, the level (container empty) does not have to be available. The associated pressure has to be entered in the "Empty pressure (029)" parameter for the "In pressure" level selection. The associated height has to be entered in the "Empty height (030)" parameter for the "In height" level selection. Factory setting: 0.0
Empty pressure (029) Empty pressure (185) Entry/Display	Enter the pressure value for the lower calibration point (container empty). → See also "Empty calib. (028)". Prerequisite <ul style="list-style-type: none"> ▪ "Level selection" = In pressure ▪ "Calibration mode" = Dry -> entry ▪ "Calibration mode" = Wet -> display Factory setting: 0.0
Empty height (030) Empty height (186) Entry/Display	Enter the height value for the lower calibration point (container empty). Select the unit via the "Height unit (026)" parameter. Prerequisite: <ul style="list-style-type: none"> ▪ "Level selection" = "In height" ▪ "Calibration mode" = Dry -> entry ▪ "Calibration mode" = Wet -> display Factory setting: 0.0
Full calib. (031) Full calib. (012) Entry	Enter the output value for the upper calibration point (container full). The unit defined in "Unit before lin. (025)" must be used.  <ul style="list-style-type: none"> ▪ In the case of wet calibration, the level (container full) must actually be available. The associated pressure is then automatically recorded by the device. ▪ In the case of dry calibration, the level (container full) does not have to be available. The associated pressure has to be entered in the "Full pressure (032)" parameter for the "In pressure" level selection. The associated height has to be entered in the "Full height (033)" parameter for the "In height" level selection. Factory setting: 100.0
Full pressure (032) Full pressure (187) Entry/Display	Enter the pressure value for the upper calibration point (container full). → See also "Full calib. (031)". Prerequisite <ul style="list-style-type: none"> ▪ "Level selection" = In pressure ▪ "Calibration mode" = Dry -> entry ▪ "Calibration mode" = Wet -> display Factory setting: Upper-range limit (URL) of the sensor
Full height (033) Full height (188) Entry/Display	Enter the height value for the upper calibration point (container full). Select the unit via the "Height unit (026)" parameter. Prerequisite: <ul style="list-style-type: none"> ▪ "Level selection" = "In height" ▪ "Calibration mode" = Dry -> entry ▪ "Calibration mode" = Wet -> display Factory setting: Upper-range limit (URL) is converted to a height unit

Parameter name	Description
Density unit (127) Display	Displays the density unit. The measured pressure is converted to a height using the "Height unit (026)" and "Adjust density (034)" parameters. Factory setting: ■ g/cm ³
Adjust density (034) Entry	Enter the density of the medium. The measured pressure is converted to a height using the "Height unit (026)" and "Adjust density (034)" parameters. Factory setting: 1.0
Process density (035) Entry	Enter a new density value for density correction. The calibration was carried out with water as the medium, for example. Now the container is to be used for another medium with another density. The calibration is corrected appropriately by entering the new density value in the "Process density (035)" parameter.  If you change to dry calibration after completing a wet calibration using the "Calibration mode (027)" parameter, the density for the "Adjust density (034)" and "Process density (035)" parameters must be entered correctly before changing the calibration mode. Factory setting: 1.0
Level before lin. (019) Display	Displays the level value prior to linearization.

Expert → Measurement → Linearization

Parameter name	Description
Lin. mode (037) Options	Select the linearization mode. Options: ■ Linear The level is output without being converted beforehand. "Level before lin. (019)" is output. ■ Erase table The existing linearization table is deleted. ■ Manual entry (sets the table to the edit mode, an alarm is output): The value pairs of the table ("X-value (040) (manual entry)" and "Y-value (041) (manual entry/in semi-auto. entry)") are entered manually. ■ Semiautomatic entry (sets the table to the edit mode, an alarm is output): The container is emptied or filled in stages in this entry mode. The device records the level value automatically ("X-value (040) (manual entry)"). The associated volume, mass or %-value is entered manually ("Y-value (041) (manual entry/in semi-auto. entry)"). ■ Activate table The table entered is activated and checked with this option. The device shows the level after linearization. Factory setting: Linear

Parameter name	Description
Unit after lin. (038) Options	Select the unit (unit of the Y-value). Options: <ul style="list-style-type: none"> ▪ % ▪ cm, dm, m, mm ▪ hl ▪ in³, ft³, m³ ▪ l ▪ in, ft ▪ kg, t ▪ lb ▪ gal ▪ lgal Factory setting: %
Line numb. (039) Entry	Enter the number of the current point in the table. The subsequent entries in "X-value (040) (manual entry)" and "Y-value (041) (manual entry/in semi-auto. entry)" refer to this point. Input range: <ul style="list-style-type: none"> ▪ 1 ... 32
X-value (040) (manual entry) X-value (123) (in linear/activ table) X-value (193) (in semi-auto. entry) Entry/Display	Enter the X-value (value before linearization) for the specific point in the table and confirm.  <ul style="list-style-type: none"> ▪ If "Lin. mode (037)" = "Manual", the level value must be entered. ▪ If "Lin. mode (037)" = "Semiautomatic", the level value is displayed and must be confirmed by entering the associated Y-value.
Y-value (041) (manual entry/in semi-auto. entry) Y-value (194) (in linear/activ table) Entry/Display	Enter the Y-value (value after linearization) for the specific point in the table. The unit is determined by "Unit after lin. (038)".  The linearization table must be monotonic (increasing or decreasing).
Edit table (042) Options	Select the function for entering the table. Options: <ul style="list-style-type: none"> ▪ Next point: The "Line numb." parameter is increased by 1. The next point can be entered. ▪ Current point: stay on the current point to correct a mistake for example. ▪ Previous point: The "Line numb." parameter is decreased by 1. The previous point can be corrected/entered again. ▪ Insert point: insert an additional point (see example below). ▪ Delete point: delete the current point (see example below). Example: Add a point - in this case between the 4th and 5th point for example <ul style="list-style-type: none"> - Select point 5 via the "Line numb. (039)" parameter. - Select the "Insert point" option via the "Edit table (042)" parameter. - Point 5 is displayed for the "Line numb. (039)" parameter. Enter new values for the "X-value (040) (manual entry)" and "Y-value (041) (manual entry/in semi-auto. entry)" parameters. Example: Delete a point - in this case the 5th point for example <ul style="list-style-type: none"> - Select point 5 via the "Line numb. (039)" parameter. - Select the "Delete point" option via the "Edit table (042)" parameter. - The 5th point is deleted. All of the subsequent points are moved up one number i.e. following deletion, the 6th point becomes Point 5. Factory setting: Current point
Tank description (173) Entry	Enter the tank description (max. 32 alphanumeric characters)
Tank content (043) Display	Displays the level value after linearization.

Expert → Measurement → Flow (Deltabar M)

Parameter name	Description
Flow type (044) Options	Select the flow type. Options: <ul style="list-style-type: none"> ▪ Volume process cond. (volume under operating conditions) ▪ Volume norm. cond. (norm volume under norm conditions in Europe: 1013.25 mbar and 273.15 K (0°C)) ▪ Volume std. cond. (standard volume under standard conditions in the USA: 1013.25 mbar (14.7 psi) and 288.15 K (15°C/59°F)) ▪ Mass (mass under operating conditions) ▪ Flow in % Factory setting: Volume process conditions
Mass flow unit (045) Options	Select mass flow unit. When a new flow unit is selected, all flow-specific parameters are converted and displayed with the new unit within a flow type. When the flow type is changed, conversion is not possible. Prerequisite: <ul style="list-style-type: none"> ▪ "Flow type (044)" = Mass Options: <ul style="list-style-type: none"> ▪ g/s, kg/s, kg/min, kg/h ▪ t/s, t/min, t/h, t/d ▪ oz/s, oz/min ▪ lb/s, lb/min, lb/h ▪ ton/s, ton/min, ton/h, ton/day Factory setting: kg/s
Norm. flow unit (046) Options	Select norm flow unit. When a new flow unit is selected, all flow-specific parameters are converted and displayed with the new unit within a flow type. When the flow type is changed, conversion is not possible. Prerequisite: <ul style="list-style-type: none"> ▪ "Flow type (044)" = Volume norm. cond. Options: <ul style="list-style-type: none"> ▪ Nm³/s, Nm³/min, Nm³/h, Nm³/d Factory setting: Nm ³ /s
Std. flow unit (047) Options	Select standard flow unit. When a new flow unit is selected, all flow-specific parameters are converted and displayed with the new unit within a flow type. When the flow type is changed, conversion is not possible. Prerequisite: <ul style="list-style-type: none"> ▪ "Flow type (044)" = Volume std. conditions Options: <ul style="list-style-type: none"> ▪ Sm³/s, Sm³/min, Sm³/h, Sm³/day ▪ SCFS, SCFM, SCFH, SCFD Factory setting: Sm ³ /s

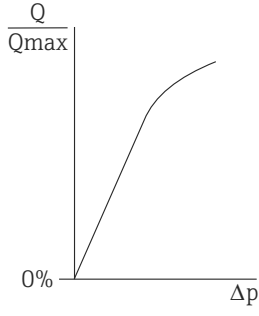
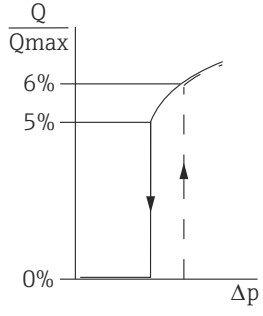
Parameter name	Description
Flow unit (048) Options	<p>Select volume flow unit. When a new flow unit is selected, all flow-specific parameters are converted and displayed with the new unit within a flow type. When the flow type is changed, conversion is not possible.</p> <p>Prerequisite:</p> <ul style="list-style-type: none"> ▪ "Flow type (044)" = Volume process cond. <p>Options:</p> <ul style="list-style-type: none"> ▪ dm^3/s, dm^3/min, dm^3/h ▪ m^3/s, m^3/min, m^3/h, m^3/d ▪ l/s, l/min, l/h ▪ hl/s, hl/min, hl/day ▪ ft^3/s, ft^3/min, ft^3/h, ft^3/d ▪ ACFS, ACFM, ACFH, ACFD ▪ ozf/s, ozf/min ▪ gal/s, gal/min, gal/h, gal/d, Mgal/d ▪ Igal/s, Igal/min, Igal/h ▪ bbl/s, bbl/min, bbl/h, bbl/d <p>Factory setting: m^3/s</p>
Max. flow (009) Entry	<p>Enter maximum flow of primary element. See also layout sheet of primary element. The maximum flow is assigned to the maximum pressure which you enter via "Max. pressure flow (010)".</p> <p>Factory setting: 100.0</p>
Max. pressure flow (010) Entry	<p>Enter maximum pressure of primary element. → See layout sheet of primary element. This value is assigned to the maximum flow value (→ see "Max. flow (009)").</p> <p>Factory setting: Upper-range limit (URL) of the sensor</p>
Set low-flow cut-off (049) Entry	<p>Enter switch-on point of the flow-flow cut-off. The hysteresis between the switch-on point and the switch-off point is always 1 % of the maximum flow value.</p> <p>Input range: Switch-off point: 0 to 50% of end flow value ("Max. flow (009)").</p> <div style="display: flex; justify-content: space-around; align-items: center;">   </div> <p>Factory setting: 5 % (of the maximum flow value)</p>
Flow (018) Display	Displays the present flow value.

Expert → Measurement → Sensor limits

Parameter name	Description
LRL sensor (101) Display	Displays the lower-range limit of the sensor.
URL sensor (102) Display	Displays the upper-range limit of the sensor.

Expert → Measurement → Sensor trim

Parameter name	Description
Lo trim measured (129) Display	Displays the reference pressure present to be accepted for the lower calibration point.
Hi trim measured (130) Display	Displays the reference pressure present to be accepted for the upper calibration point.
Lo trim sensor (131) Display	Internal service parameter.
Hi trim sensor (132) Display	Internal service parameter.

8.11.3 Communication**Expert → Communication → FF Info**

Parameter name	Description
Device type code (236) Display	The "Device type code (236)" is the unique device ID in the control system or the FF bus. It consists of the manufacturer ID (452B48), device type number and device serial number. Example: Deltabar M: 452B481021-6B032A0109D
Device revision (237) Display	Displays the revision or version of a complete device (HW+SW). Example: 1
Device address (244) Display	Displays the device address currently configured and valid. Factory setting: 247
Device class (245) Display	Displays the device class currently configured. The device can be configured as a "Basic device" or "Link master". Factory setting: Basic device

Expert → Communication → Resource Block (only with FieldCare)See →  166 ff.**Expert → Communication → Transducer Blocks (only with FieldCare)**See →  176 ff.

Expert → Communication → Analog Input 1 to 5

Analog Input	Parameter name (Display Id)	Explanation
1	Channel/CHANNEL (171)	See the following table.
	Out value (195)	
	Out status (196)	
2	Channel/CHANNEL (200)	
	Out value (201)	
	Out status (202)	
3	Channel/CHANNEL (238)	
	Out value (239)	
	Out status (240)	
4	Channel/CHANNEL (241)	
	Out value (242)	
	Out status (243)	
5 (Deltabar M)	Channel/CHANNEL (255)	
	Out value (256)	
	Out status (257)	

Parameter name	Description			
Channel/CHANNEL Display	The current selected Channel/CHANNEL is displayed for instantiated analog inputs. The following list indicates the possible channels:			
	Channel/CHANNEL	(Set as Default for pre-instantiated Block)	English text	German Text
	1	(AI 1)	Primary value	Hauptmesswert
	2 *)	(AI 2) Cerabar/Deltapilot	Sensor temperature *)	Sensortemperatur *)
	3	(AI 2) Deltabar	Pressure	Druck gemessen
	4	-	Max. pressure	Maximaler Druck
	5	-	Level before linearization	Füllstand vor Linearisierung
			Totalizer 1	Summenzähler 1
			Totalizer 2	Summenzähler 2
Out value Display	The current value is displayed for instantiated analog inputs, along with the individual units.			
Out status Display	The current status is displayed for instantiated analog inputs. The following list indicates the status and the related text of the AI OUT value:			
	Status		Text	
	Bad	=	BAD	
	Uncertain	=	UNCERTAIN	
	Good non-cascaded	=	GOOD	
	Good cascaded	=	GOOD	

*) Not available for Deltabar M.

8.11.4 Application

Expert → Application (Cerabar M and Deltapilot M)

Parameter name	Description
Electr. delta P (158) Entry	For switching the electr. delta P application on or off with an external or constant value. Options: Off External value Constant Factory setting: Off
Fixed ext. value (174) Entry	Use this function to enter the constant value. The value refers to " Press. eng. unit (125) ". Factory setting: 0.0
E.Delta p selec. (246) Entry	Select which input of the Input Selector Block is chosen as the input value for Electrical Delta P. The input is selected from a picklist (Input1 - Input4). This list corresponds to the inputs of the Input Selector Block. The Block is always instantiated and does not have to be in the Auto mode. Factory setting: Input1
E.Delta p value (247) Entry	The corresponding Electrical Delta P. value is displayed for the selected input.
E.Delta p status (248) Entry	The corresponding Electrical Delta P. status is displayed for the selected input. The following list indicates the status and the text associated with the status: Status = Text Bad = BAD Uncertain = UNCERTAIN Good non-cascaded = GOOD Good cascaded = GOOD
E.Delta p unit (249) Entry	Select which unit corresponds to the value of the selected inputs. Factory setting: mbar

Expert → Application → Totalizer 1 (Deltabar M)



With the "Flow in %" flow type setting, the totalizer is not available and is not displayed at this position.

Parameter name	Description
Eng. unit totalizer 1 (058) (059) (060) (061) Options	Select unit for totalizer 1. Options Depending on the setting in the " Flow type (044) " parameter, this parameter offers a list of volume, norm volume, standard volume and mass units. When a new volume or mass unit is selected, totalizer-specific parameters are converted and displayed with the new unit within a unit group. When the flow mode is change, the totalizer value is not converted. The Direct Access Code depends on the selected " Flow type (044) ": – (058): Flow. meas. type "Mass" – (059): Flow. meas. type "Volume norm. cond." – (060): Flow. meas. type "Volume std. cond." – (061): Flow. meas. type "Volume process cond." Factory setting: m ³
Totalizer 1 mode (175) Options	Define the behavior of the totalizer. Options: <ul style="list-style-type: none"> ▪ Balanced: Integration of all measured flows (positive and negative) ▪ Pos. flow only: only positive flows are integrated. ▪ Neg. flow only: only negative flows are integrated. ▪ Hold: The totalizer is stopped and keeps its current value. Factory setting: Pos. flow only
Totalizer 1 failsafe (176)	Define the behavior of the totalizer in the case of an error. Options: <ul style="list-style-type: none"> ▪ Actual value (It is integrated with the current flow value on.) ▪ Hold: The totalizer is stopped and keeps its current value. Factory setting: Actual value
Reset Totalizer 1 (062) Options	You reset totalizer 1 to zero with this parameter. Options: <ul style="list-style-type: none"> ▪ Abort (do not reset) ▪ Reset Factory setting: Abort
Totalizer 1 (063) Display	Displays the total value of totalizer 1. You can reset the value with the " Reset Totalizer 1 (062) " parameter. The " Totalizer 1 overflow (064) " parameter displays the overflow. Example: The value 123456789 m ³ is indicated as follows: – Totalizer 1: 3456789 m ³ – Totalizer 1 overflow: 12 E7 m ³
Totalizer 1 overflow (064) Display	Displays the overflow value of totalizer 1. → See also " Totalizer 1 (063) ".

Expert → Application → Totalizer 2 (Deltabar M)



With the "Flow in %" flow type setting, the totalizer is not available and is not displayed at this position.

Parameter name	Description
Eng. unit totalizer 2 (065) (066) (067) (068) Options	Select the unit for totalizer 2. → See also "Eng. unit totalizer 1". The Direct Access Code depends on the selected " Flow type (044) ": - (065): Flow. meas. type "Mass" - (066): Flow. meas. type "Gas norm. cond." - (067): Flow. meas. type "Gas. std. cond." - (068): Flow. meas. type "Volume process cond." Factory setting: m ³
Totalizer 2 mode (177)	Define the behavior of the totalizer. Options: <ul style="list-style-type: none"> ▪ Balanced: Integration of all measured flows (positive and negative) ▪ Pos. flow only: only positive flows are integrated. ▪ Neg. flow only: only negative flows are integrated. ▪ Hold: The totalizer is stopped and keeps its current value. Factory setting: Pos. flow only
Totalizer 2 failsafe (178)	Define the behavior of the totalizer in the case of an error. Options: <ul style="list-style-type: none"> ▪ Actual value: It is integrated with the current flow value on. ▪ Hold: The totalizer is stopped and keeps its current value. Factory setting: Actual value
Totalizer 2 (069) Display	Displays the totalizer value. The Totalizer 2 overflow (070) parameter displays the overflow. → See the example for "Totalizer 1".
Totalizer 2 overflow (070) Display	Displays the overflow value of totalizer 2. → See also " Totalizer 2 (069) " and example for totalizer 1.

8.11.5 Diagnosis

Expert → Diagnosis

Parameter name	Description
Diagnostic code (071) Display	Displays the diagnostic message with the highest priority currently present.
Last diag. code (072) Display	Displays the last diagnostic message that occurred and was rectified.  <ul style="list-style-type: none"> ▪ Digital communication: the last message is displayed. ▪ The messages listed in the "Last diag. code (072)" parameter can be deleted via the "Reset logbook (159)" parameter.

Parameter name	Description
Reset logbook (159) Options	With this parameter, you reset all the messages of the " Last diag. code (072) " parameter and the "Last diag. 1 (085)" to "Last diag. 10 (094)" event log. Options: <ul style="list-style-type: none"> ▪ Abort ▪ Confirm Factory setting: Abort
Min. meas. press. (073) Display	Displays the lowest pressure value measured (peakhold indicator). You can reset this indicator by means of the " Reset peakhold (161) " parameter.
Max. meas. press. (074) Display	Displays the highest pressure value measured (peakhold indicator). You can reset this indicator by means of the " Reset peakhold (161) " parameter.
Reset peakhold (161) Options	You can reset the "Min. meas. press." and "Max. meas. press." indicators with this parameter. Options: <ul style="list-style-type: none"> ▪ Abort ▪ Confirm Factory setting: Abort
Alarm behav. P (050) Selection	Configure the current output for when the sensor limits are undershot or overshot. Options: <ul style="list-style-type: none"> ▪ Warning The device continues measuring. An error message is displayed. The measuring value status shows "UNCERTAIN". ▪ Alarm The measuring value status shows "BAD". An error message is displayed Factory setting: Warning
Operating hours (162) Display	Displays the hours of operation. This parameter cannot be reset.
Config. counter (100) Display	Displays the configuration counter. This counter is increased by one every time a parameter or group is changed. The counter counts up to 65535 and then starts again at zero.

Expert → Diagnosis → Diagnostic list

Parameter name	Description
Diagnostic 1 (075) Diagnostic 2 (076) Diagnostic 3 (077) Diagnostic 4 (078) Diagnostic 5 (079) Diagnostic 6 (080) Diagnostic 7 (081) Diagnostic 8 (082) Diagnostic 9 (083) Diagnostic 10 (084)	These parameters contain up to ten diagnosis messages that are currently pending, arranged in order of priority.

Expert → Diagnosis → Event logbook

Parameter name	Description
Last diag. 1 (085) Last diag. 2 (086) Last diag. 3 (087) Last diag. 4 (088) Last diag. 5 (089) Last diag. 6 (090) Last diag. 7 (091) Last diag. 8 (092) Last diag. 9 (093) Last diag. 10 (094)	These parameters contain the last 10 diagnosis messages to occur and be rectified. They can be reset using the "Reset logbook (159)" parameter. Errors which have occurred multiple times are displayed once only.

Expert → Diagnosis → Simulation

Parameter name	Description
Simul. switch (251) Display	Displays the switch position of DIP switch 3 which is used to switch the simulation of the Analog Input output signal on and off. Display: <ul style="list-style-type: none"> ▪ Off Simulation of the output signal is disabled. ▪ On Simulation of the output signal is enabled. The output signal can be simulated. Factory setting: Off

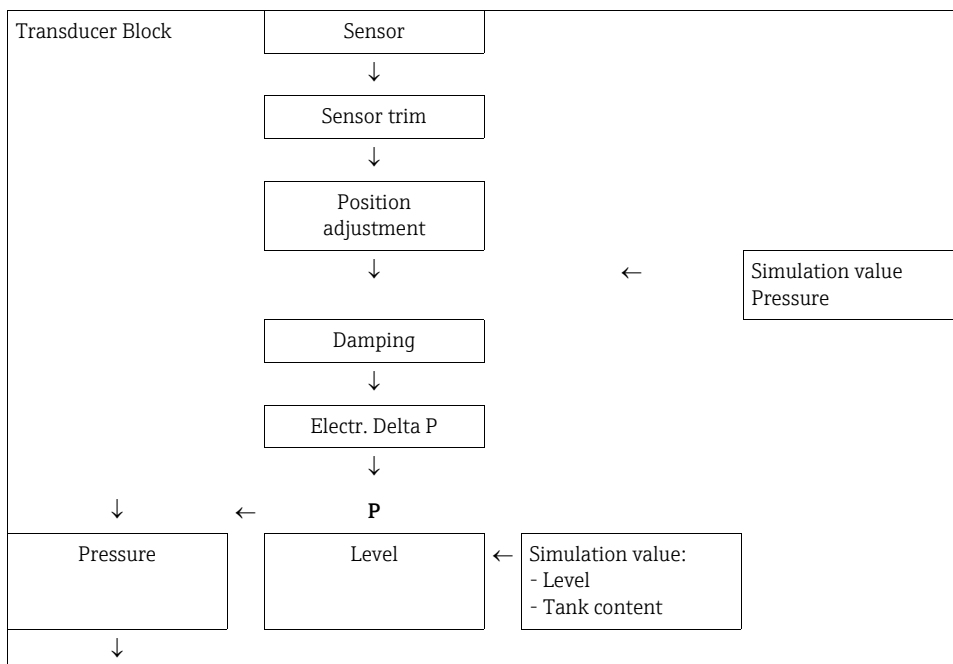

Simulation mode (112) Options	Switch on simulation and select the simulation mode. Any simulation running is switched off if the measuring mode or Lin. mode (037) level mode is changed. Options: <ul style="list-style-type: none"> ▪ None ▪ Pressure, → see also this table, "Sim. pressure" parameter ▪ Level, → see this table, "Sim. level" parameter ▪ Flow, → see this table, "Sim. flow" parameter ▪ Tank content, → see this table, "Sim. tank cont." parameter ▪ Alarm/warning, → see this table, "Sim. error no." parameter
---	---

Cerabar M /
Deltapilot M



Parameter name	Description																								
→	<p style="text-align: center;">PV PV = Primary Value</p> <p style="text-align: center;">↓</p> <div style="text-align: center; border: 1px solid black; padding: 5px; width: fit-content; margin: 0 auto;">Analog Input Block</div> <p>Deltabar M</p> <table border="1" style="width: 100%; border-collapse: collapse;"> <tr> <td style="width: 30%;">Transducer Block</td> <td style="text-align: center;"> <div style="border: 1px solid black; padding: 2px; margin-bottom: 5px;">Sensor</div> <div style="text-align: center;">↓</div> <div style="border: 1px solid black; padding: 2px; margin-bottom: 5px;">Sensor trim</div> <div style="text-align: center;">↓</div> <div style="border: 1px solid black; padding: 2px; margin-bottom: 5px;">Position adjustment</div> <div style="text-align: center;">↓</div> <div style="border: 1px solid black; padding: 2px; margin-bottom: 5px;">Damping</div> <div style="text-align: center;">↓</div> <div style="text-align: center;">P</div> </td> <td style="width: 30%;"></td> <td style="width: 10%;"></td> <td style="width: 10%;"></td> <td style="width: 10%;"></td> </tr> <tr> <td style="text-align: center;">↓</td> <td style="text-align: center;">←</td> <td style="border: 1px solid black; padding: 5px;">Pressure</td> <td style="text-align: center;">←</td> <td style="border: 1px solid black; padding: 5px;">Simulation value Pressure</td> <td></td> </tr> <tr> <td style="text-align: center;">↓</td> <td style="text-align: center;">←</td> <td style="border: 1px solid black; padding: 5px;">Level</td> <td style="text-align: center;">←</td> <td style="border: 1px solid black; padding: 5px;">Simulation value: - Level - Tank content</td> <td></td> </tr> <tr> <td style="text-align: center;">↓</td> <td style="text-align: center;">←</td> <td style="border: 1px solid black; padding: 5px;">Flow</td> <td style="text-align: center;">←</td> <td style="border: 1px solid black; padding: 5px;">Simulation value: - Flow</td> <td></td> </tr> </table> <p style="text-align: center;">→</p> <p style="text-align: center;">↓</p> <div style="text-align: center; border: 1px solid black; padding: 5px; width: fit-content; margin: 0 auto;">Analog Input Block</div>	Transducer Block	<div style="border: 1px solid black; padding: 2px; margin-bottom: 5px;">Sensor</div> <div style="text-align: center;">↓</div> <div style="border: 1px solid black; padding: 2px; margin-bottom: 5px;">Sensor trim</div> <div style="text-align: center;">↓</div> <div style="border: 1px solid black; padding: 2px; margin-bottom: 5px;">Position adjustment</div> <div style="text-align: center;">↓</div> <div style="border: 1px solid black; padding: 2px; margin-bottom: 5px;">Damping</div> <div style="text-align: center;">↓</div> <div style="text-align: center;">P</div>					↓	←	Pressure	←	Simulation value Pressure		↓	←	Level	←	Simulation value: - Level - Tank content		↓	←	Flow	←	Simulation value: - Flow	
Transducer Block	<div style="border: 1px solid black; padding: 2px; margin-bottom: 5px;">Sensor</div> <div style="text-align: center;">↓</div> <div style="border: 1px solid black; padding: 2px; margin-bottom: 5px;">Sensor trim</div> <div style="text-align: center;">↓</div> <div style="border: 1px solid black; padding: 2px; margin-bottom: 5px;">Position adjustment</div> <div style="text-align: center;">↓</div> <div style="border: 1px solid black; padding: 2px; margin-bottom: 5px;">Damping</div> <div style="text-align: center;">↓</div> <div style="text-align: center;">P</div>																								
↓	←	Pressure	←	Simulation value Pressure																					
↓	←	Level	←	Simulation value: - Level - Tank content																					
↓	←	Flow	←	Simulation value: - Flow																					
Sim. pressure (113) Entry	Enter the simulation value. → See also " Simulation mode (112) ". Prerequisite: ■ " Simulation mode (112) " = Pressure Value when switched on: Current pressure measured value																								
Sim. flow (114) (Deltabar M) Entry	Enter the simulation value. → See also " Simulation mode (112) ". Prerequisite: ■ " Measuring mode (005) " = Flow and " Simulation mode (112) " = Flow																								
Sim. level (115) Entry	Enter the simulation value. → See also " Simulation mode (112) ". Prerequisite: ■ " Measuring mode (005) " = Level and " Simulation mode (112) " = Level																								
Sim. tank cont. (116) Entry	Enter the simulation value. → See also " Simulation mode (112) ". Prerequisites: ■ " Measuring mode (005) " = Level, " Lin. mode (037) " = "Activate table" and " Simulation mode (112) " = Tank content.																								
Sim. error no. (118) Entry	Enter the diagnostic message number. → See also " Simulation mode (112) ". Prerequisite: ■ " Simulation mode (112) " = Alarm/warning Value when switched on: 484 (simulation active)																								

8.11.6 Backup or duplicate device data

The device has no memory module. With an operating tool based on FDT technology (e.g. FieldCare), you have the following options (see parameter "**Download select**" →  119 in operating menu or via Resource block →  173):

- Saving/rescuing configuration data
- Duplicating instrument configurations
- Transferring all relevant parameters when replacing electronic inserts.

For more information, read the operating manual for the FieldCare operating program.

9 Commissioning with the FF configuration program

The device is configured at the factory for the Pressure measuring mode (Cerabar, Deltabar) or Level measuring mode (Deltapilot). The measuring range and the unit in which the measured value is transmitted correspond to the specifications on the nameplate.

▲ WARNING

Exceeding the maximum allowable working pressure!

Risk of injury due to bursting of parts! Warning messages are generated if pressure is too high.

- ▶ If a pressure smaller than the minimum permitted pressure or greater than the maximum permitted pressure is present at the device, the following messages are output in succession (depending on the setting in the "Alarm behavior" (050) parameter):
 - "S140 Working range P" or "F140 Working range P"
 - "S841 Sensor range" or "F841 Sensor range"
 - "S971 Adjustment"
 Use the device only within the sensor range limits.

NOTICE



Shortfall of the allowable working pressure!

Output of messages if pressure is too low.

- ▶ If a pressure smaller than the minimum permitted pressure or greater than the maximum permitted pressure is present at the device, the following messages are output in succession (depending on the setting in the "Alarm behavior" (050) parameter):
 - "S140 Working range P" or "F140 Working range P"
 - "S841 Sensor range" or "F841 Sensor range"
 - "S971 Adjustment"
 Use the device only within the sensor range limits.

9.1 Function check



Carry out a post-installation and a post-connection check as per the checklist before commissioning the device.

- "Post-installation check" checklist →  37
- "Post-connection check" checklist →  43

9.2 Commissioning with FF application

▲ CAUTION

Note Dependencies when setting parameters!

- ▶ The device is configured at the factory for the Pressure measuring mode (Cerabar, Deltabar) or Level measuring mode (Deltapilot). The measuring range and the unit in which the measured value is transmitted, as well as the digital output value of the Analog Input Block OUT, correspond to the data on the nameplate. Following a reset with code 7864, the OUT parameter may have to be rescaled (→ see also Page 141, Section 9.3 "Scaling the OUT parameter").
- ▶ The standard order configuration is illustrated on →  59, Section 6.4.6 "Block model".
- ▶ The "xxxxxxxxxx" characters used in the following sections are placeholders for the serial number.
 1. Switch on the device.
 2. Note the DEVICE_ID. →  58, Section 6.4.5 "Device identification and addressing" and →  8, Section 3.2.1 "Nameplate" for the device serial number.
 3. Open the configuration program.

4. Load Cff and device description files into the host system or the configuration program. Make sure you are using the right system files.
5. Identify the device using the DEVICE_ID (→ see Point 2). Assign the desired tag name to the device by means of the "Pd-tag/FF_PD_TAG" parameter.

Configuring the Resource Block

1. Open the Resource Block.
2. If necessary, disable the lock for device operation. → 54, Section 6.3.5 "Locking/unlocking operation". Operating is unlocked as standard.
3. If necessary, change the block name. Factory setting: RS-xxxxxxxxxx (RB2) ()
4. If necessary, assign a description to the block by means of the "Tag Description/TAG_DESC" parameter.
5. If necessary, change other parameters as per the requirements.

Configuring the Transducer Blocks

The device has the following Transducer Blocks:

- Pressure Transducer Block
- DP_FLOW Block (Deltabar)
- Display Transducer Block
- Diagnostic Transducer Block

The explanation that follows is an example for the Pressure Transducer Block.

1. If necessary, change the block name. Factory setting: TRD1_xxxxxxxxxx (PCD)
2. Set the block mode to OOS by means of the "Block Mode/MODE_BLK", TARGET element.
3. Configure the device in accordance with the measuring task. → See also these Operating Instructions Section 8.2 to Section 9.3.
4. Set the block mode to "Auto" by means of the "Block Mode/MODE_BLK" parameter, TARGET element.

CAUTION

Note Dependencies when setting parameters!

- The block mode must be set to "Auto" for the Pressure and DP_FLOW Block (Deltabar) for the measuring device to function correctly.

Configuring the Analog Input Blocks

The device has 2 Analog Input Blocks that can be assigned as required to the various process variables.

1. If necessary, change the block name. Factory setting: AI1_xxxxxxxxxx (AI)
2. Set the block mode to OOS by means of the "Block Mode/MODE_BLK" parameter, TARGET element.
3. Use the "Channel/CHANNEL" parameter to select the process variable which should be used as the input value for the Analog Input Block. The following settings are possible:

Cerabar and Deltapilot:

- Channel/CHANNEL = 1: Primary value, a pressure or level value depending on the measuring mode selected
- Channel/CHANNEL = 2: Secondary value
- Channel/CHANNEL = 3: Pressure
- Channel/CHANNEL = 4: Max. pressure
- Channel/CHANNEL = 5: Level before linearization

Factory setting:

- Analog Input Block 1: Channel/CHANNEL = 1: Primary Value (primary measured value)
- Analog Input Block 2: Channel/CHANNEL = 2: Secondary Value (sensor temperature)

Deltabar:

- Channel/CHANNEL = 1: Primary value, a pressure or flow value depending on the measuring mode selected
- Channel/CHANNEL = 3: Pressure
- Channel/CHANNEL = 4: Max. pressure
- Channel/CHANNEL = 5: Level before linearization
- Channel/CHANNEL = 6: Totalizer 1
- Channel/CHANNEL = 7: Totalizer 2

Factory setting:

- Analog Input Block 1: Channel/CHANNEL = 1: Primary Value (primary measured value)
- Analog Input Block 2: Channel/CHANNEL = 3: Pressure

4. Use the "Transducer Scale/XD_SCALE" parameter to select the desired unit and the block input range for the process variable. → 141, Section 9.3 "Scaling the OUT parameter". Make sure that the unit selected suits the process variable selected. If the process variable does not suit the unit, the "Block Error/BLOCK_ERR" parameter reports "Block Configuration Error" and the block mode cannot be set to "Auto".
5. Use the "Linearization Type/L_TYPE" parameter to select the type of linearization for the input variable (factory setting: Direct). Make sure that the settings for the "Transducer Scale/XD_SCALE" and "Output Scale/OUT_SCALE" parameters are the same for the "Direct" linearization type. If the values and units do not match, the Block Error/BLOCK_ERR parameter reports "Block Configuration Error" and the block mode cannot be set to "Auto".
6. Enter the alarm and critical alarm messages by means of the "High High Limit/ HI_HI_LIM", "High Limit/HI_LIM", "Low Low Limit/LO_LO_LIM" and "Low Limit/LO_LIM" parameters. The limit values entered must be within the value range specified for the "Output Scale/OUT_SCALE" parameter.
7. Specify the alarm priorities by means of the "High High Priority/HI_HI_PRI", "High Priority/HI_PRI", "Low Low Priority/LO_LO_PRI" and "Low Priority/LO_PRI" parameters. Reporting to the field host system only takes place with alarms with a priority greater than 2.
8. Set the block mode to "Auto" using the "Block Mode/MODE_BLK" parameter, TARGET element. For this purpose, the Resource Block must also be set to the "Auto" block mode.

Additional configuration

1. Link the function blocks and output blocks.
2. After specifying the active LAS, download all the data and parameters to the field device.

9.3 Scaling the OUT parameter

In the Analog Input Block, the input value or input range can be scaled in accordance with the automation requirements.

Example:

The measuring range 0 to 500 mbar should be rescaled to 0 to 100 %.

- Select XD_SCALE group.
 - For EU_0, enter "0".
 - For EU_100, enter "500".
 - For UNITS_INDEX, enter "mbar".
- Select OUT_SCALE group.
 - For EU_0, enter "0".
 - For EU_100, enter "100%".
 - For UNITS_INDEX, select "%" for example.

The unit selected here does not have any effect on the scaling.

Result:

At a pressure of 350 mbar, the value 70 is output to a downstream block or to the PCS as the OUT value.

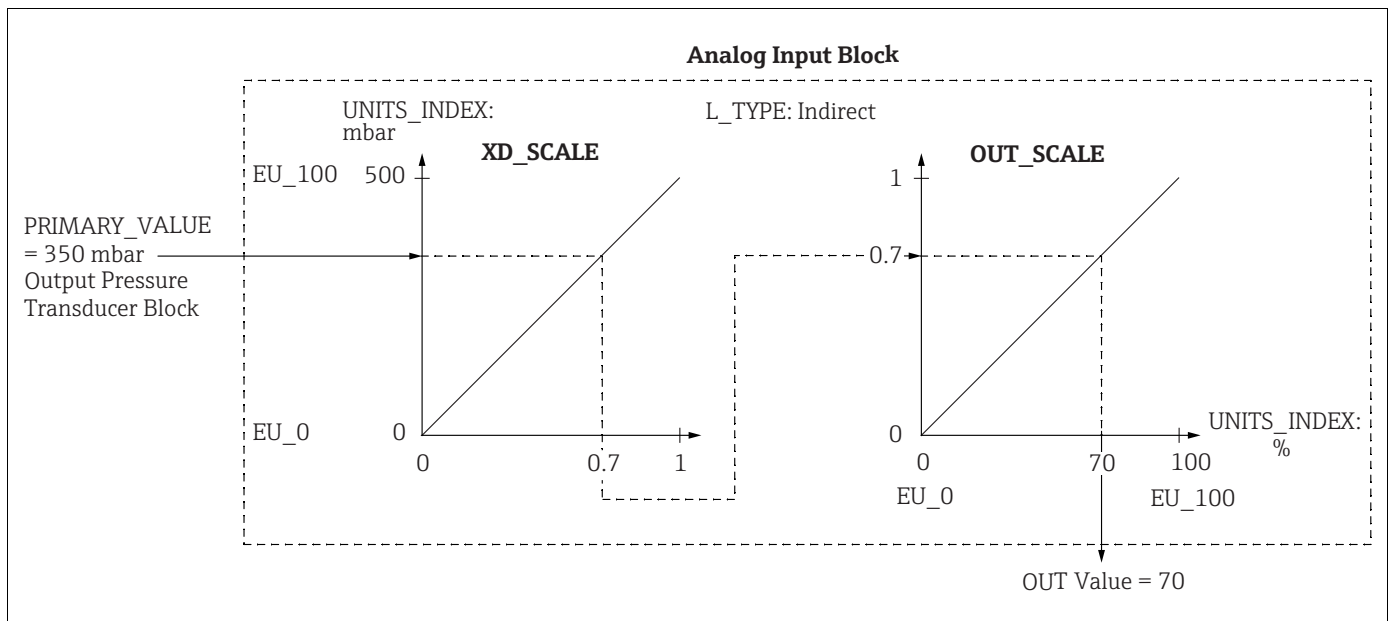

⚠ CAUTION

Note Dependencies when setting parameters!

- ▶ If you have selected the "Direct" mode for the L_TYPE parameter, you cannot change the values and units for XD_SCALE and OUT_SCALE.
- ▶ The L_TYPE, XD_SCALE and OUT_SCALE parameters can only be changed in the OOS block mode.
- ▶ Make sure that the output scaling of the Pressure Transducer Block SCALE_OUT matches the input scaling of the Analog Input Block XD_SCALE.

9.4 Commissioning with device application

Commissioning comprises the following steps:

1. Function check (→ [71](#))
2. Selecting the language, measuring mode and pressure unit
3. Position adjustment (→ [144](#))
4. Configuring measurement:
 - Pressure measurement (→ [145 ff](#))
 - Level measurement (→ [146 ff](#))
 - Flow measurement (Deltabar M) (Deltabar) (→ [155 ff](#))

9.4.1 Selecting the language, measuring mode and pressure unit

Language selection (Display Transducer Block)

Parameter name	Description
Language/ DISPLAY_LANGUAGE Options Index: 14 Data type: unsigned8 Access: wr for Auto, OOS	Select language. Options: <ul style="list-style-type: none"> ▪ English ▪ Possibly another language (as selected when ordering the device) ▪ One further language (language of the manufacturing plant) Factory setting: English

Measuring mode selection (Pressure Transducer Block)

Parameter name	Description
Measuring mode/ OPERATING_MODE Index: 42 Data type: unsigned8 Access: OOS	Select the measuring mode. The operating menu is structured differently depending on the measuring mode selected.  If the measuring mode is changed, no conversion takes place. If necessary, the device has to be recalibrated after the measuring mode has been changed. Options: <ul style="list-style-type: none"> ▪ Pressure ▪ Level ▪ Flow (Deltabar) Factory setting: Pressure

Pressure unit selection (Pressure Transducer Block)

Parameter name	Description
Calibration Units/ CAL_UNIT Entry Index: 19 Data type: unsigned16 Access: OOS	Select the pressure unit. If a new pressure unit is selected, all pressure-specific parameters are converted and displayed with the new unit. Options <ul style="list-style-type: none"> ▪ mbar, bar ▪ mmH₂O, mH₂O, inH₂O, ftH₂O ▪ Pa, hPa, kPa, MPa ▪ psi ▪ mmHg, inHg ▪ Torr ▪ g/cm², kg/cm² ▪ lb/ft² ▪ atm ▪ gf/cm², kgf/cm² Factory setting: mbar or bar depending on the sensor nominal measuring range, or as per order specifications

9.5 Pos. Zero Adjust

The pressure resulting from the orientation of the device can be corrected here.

(Pressure Transducer Block)

Parameter name	Description
Pos. zero adjust/ PRESSURE_1_ACCEPT_ZERO_INSTALL Options Index: 38 Data type: unsigned8 Access: OOS	<p>Due to the orientation of the device, there may be a shift in the measured value, i.e. for example, when the container is empty or partially full, the Primary Value/PRIMARY_VALUE parameter does not display zero.</p> <p>This parameter provides the possibility of performing position adjustment where the pressure difference between zero (set point) and the measured pressure need not be known. (A reference pressure is present at the device.)</p> <p>Example:</p> <ul style="list-style-type: none"> - Primary Value/PRIMARY_VALUE = 2.2 mbar - Correct the Primary Value/PRIMARY_VALUE via the Pos. zero adjust/PRESSURE_1_ACCEPT_ZERO_INSTALL parameter with the "Confirm" option. This means that you are assigning the value 0.0 to the pressure present. - Primary Value/PRIMARY_VALUE (after pos. zero adjust) = 0.0 mbar <p>The Calib. offset/PRESSURE_1_INSTALL_OFFSET parameter (→ 144) displays the resulting pressure difference (offset) by which the Primary Value/PRIMARY_VALUE was corrected.</p> <p>Options:</p> <ul style="list-style-type: none"> ▪ Abort ▪ Confirm <p>Factory setting: Abort</p>
Calib. offset/ PRESSURE_1_INSTALL_OFFSET Entry Index: 39 Data type: float Access: OOS	<p>Due to the orientation of the device, there may be a shift in the measured value, i.e. for example, when the container is empty or partially full, the Primary Value/PRIMARY_VALUE parameter does not display zero or the desired value.</p> <p>This parameter provides the possibility of performing position adjustment where the pressure difference between zero (set point) and the measured pressure is known. (A reference pressure is not present at the device.)</p> <p>Example:</p> <ul style="list-style-type: none"> - Primary Value/PRIMARY_VALUE = 2.2 mbar - Via the Calib. offset/PRESSURE_1_INSTALL_OFFSET parameter, enter the value by which the Primary Value/PRIMARY_VALUE should be corrected. To correct the Primary Value/PRIMARY_VALUE to 0.0 mbar, you must enter the value 2.2 here. (The following applies: $PRIMARY_VALUE_{new} = PRIMARY_VALUE_{old} - PRESSURE_1_INSTALL_OFFSET$) - Primary Value/PRIMARY_VALUE (after entry for calib. offset) = 0.0 mbar <p>Factory setting: 0.0</p>

9.6 Pressure measurement

In this chapter the parameter text as well as the parameter name are indicated. In FF configuration programs only the parameter text is displayed (exception: in the NI-FBUS configurator you can select if the parameter text or the parameter name is displayed).

Example:

Parameter text	Parameter name
Linearization	LINEARIZATION



- The Cerabar M and the Deltabar M are configured for the pressure measuring mode as standard. The Deltapilot M is configured for the level measuring mode as standard. The measuring range and the unit in which the measured value is transmitted, as well as the digital output value of the Analog Input Block OUT, correspond to the data on the nameplate.
- For a description of the parameters mentioned, see
 - → [178](#), Pressure Transducer Block
 - → [208](#), Analog Input Block.

Description	
1	Deltabar M: Before configuring the device for your application, the pressure piping must be cleaned and the device filled with medium.
2	Open the Pressure Transducer Block and set the block mode to OOS.
3	Select the measuring mode if necessary: <ul style="list-style-type: none"> ■ Depending on the sensor, select the "Differential pressure", "Gauge pressure" or "Absolute pressure" option by means of the Primary Value Type/ PRIMARY_VALUE_TYPE parameter.
4	Set the Pressure Transducer Block to the "Auto" block mode.
5	If necessary, configure the Channel/CHANNEL (→ 211), Linearization Type/L_TYPE (→ 212), Transducer Scale/XD_SCALE (→ 210) and Output Scale/OUT_SCALE (→ 211) parameters by means of the Analog Input Block.
6	Result: The device is ready for pressure measurement.



You can select another pressure unit by means of the Calibration Units/CAL_UNIT (→ [143](#)) parameter. You can also specify a customer-specific unit by means of this parameter.

9.7 Level measurement

In this chapter the parameter text as well as the parameter name are indicated.

In FF configuration programs only the parameter text is displayed (exception: in the NI-FBUS configurator you can select if the parameter text or the parameter name is displayed).

Example:

Parameter text	Parameter name
Linearization	LINEARIZATION

9.7.1 Information on level measurement

▲ CAUTION

Note Dependencies when setting parameters!

- ▶ You have a choice of two methods for calculating the level: "In pressure" and "In height". The table in the "Overview of level measurement" section that follows provides you with an overview of these two measuring tasks.
- ▶ The limit values are not checked, i.e. the values entered must be appropriate for the sensor and the measuring task for the device to be able to measure correctly.
- ▶ Customer-specific units are not possible.
- ▶ There is no unit conversion.
- ▶ The values entered for "Empty calib. (028)/Full calib. (031)", "Empty pressure (029)/Full pressure (032)", "Empty height (030)/Full height (033)" must be at least 1 % apart. The value will be rejected, and a warning message displayed, if the values are too close together.

9.7.2 Overview of level measurement

Measuring task	Level selection	Measured variable options	Description	Measured value display
Calibration is performed by entering two pressure-level value pairs.	"In pressure"	Via the "Unit before lin. (025)" parameter: %, level, volume or mass units.	<ul style="list-style-type: none"> - Calibration with reference pressure (wet calibration), see → 75 - Calibration without reference pressure (dry calibration), see → 77 	The measured value display and the "Level before lin. (019)" parameter display the measured value.
Calibration is performed by entering the density and two height-level value pairs.	"In height"		<ul style="list-style-type: none"> - Calibration with reference pressure (wet calibration), see → 81 - Calibration without reference pressure (dry calibration), see → 79 	

9.7.3 "In pressure" level selection

Calibration with reference pressure – wet calibration

Example:

In this example, the level in a tank should be measured in "m". The maximum level is 3 m. The pressure range is set to 0 to 300 mbar.

Prerequisite:

- The measured variable is in direct proportion to the pressure.
- The tank can be filled and emptied.

⚠ CAUTION

Note Dependencies when setting parameters!

- ▶ The values entered for Empty calibration/LOW_LEVEL_EASY and Full calib./HIGH_LEVEL_EASY must be at least 1% apart for the "Level easy pressure" level mode. The value will be rejected, and a warning message displayed, if the values are too close together. Further limit values are not checked; i.e. the values entered must be appropriate for the sensor and the measuring task so that the measuring device can measure correctly.
- ▶ Due to the orientation of the device, there may be a shift in the measured value, i.e. when the container is empty, the Primary Value/PRIMARY_VALUE does not display zero. → For information on how to perform position adjustment, see also → 144, "Pos. zero adjust/PRESSURE_1_ACCEPT_ZERO_INSTALL".

Description	
1	Deltabar M: Before configuring the device for your application, the pressure piping must be cleaned and filled with medium.
2	Open the Pressure Transducer Block and set the block mode to OOS.

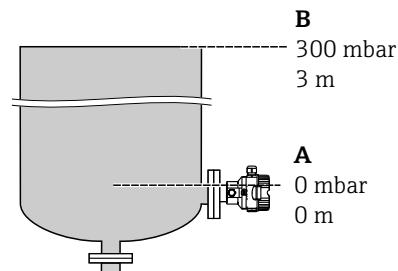

B
300 mbar
3 m

A
0 mbar
0 m

A0030028

Fig. 40: Calibration with reference pressure – wet calibration

A See Table, Step 7.
B See Table, Step 9.

Description	
3	Select the measuring mode if necessary: <ul style="list-style-type: none"> Select the "Level" option by means of the Primary Value Type/PRIMARY_VALUE_TYPE parameter. Or:
4	Select the "In pressure" option via the Level selection/LEVEL_ADJUSTMENT parameter.
5	By means of the "Units index" Scale Out/SCALE_OUT parameter, select the "m" option. Or select a level unit by means of the Unit before Lin./OUT_UNIT_EASY parameter, here "m" for example.
6	Select the "Wet" option by means of the Calibration mode/LEVEL_ADJUST_MODE_EASY parameter.
7	Fill the container up to the lower level point. The associated pressure value can be viewed by means of the Meas. pressure/PRESSURE_1_FINAL_VALUE parameter.
8	By means of the Scale Out/SCALE_OUT ¹⁾ record parameter, "EU at 0%/E_ENGINERING_UNIT_0_PERCENT" elements, enter a level value, here 0 m for example. Or enter a level value via the Empty calibration/LOW_LEVEL_EASY parameter, here 0 m for example.
9	Fill the container up to the upper level point. The associated pressure value can be viewed by means of the Meas. pressure/PRESSURE_1_FINAL_VALUE parameter.
10	By means of the Scale Out/SCALE_OUT ¹⁾ record parameter, "EU at 100%/E_ENGINERING_UNIT_100_PERCENT" elements, enter a level value, here 3 m for example. Or enter a level value via the Full calib./HIGH_LEVEL_EASY parameter, here 3 m for example.
11	Set the Pressure Transducer Block to the "Auto" block mode.
12	If necessary, configure the Channel/CHANNEL (→ 211), Linearization Type/L_TYPE (→ 212), Transducer Scale/XD_SCALE (→ 210) and Output Scale/OUT_SCALE (→ 211) parameters by means of the Analog Input Block.

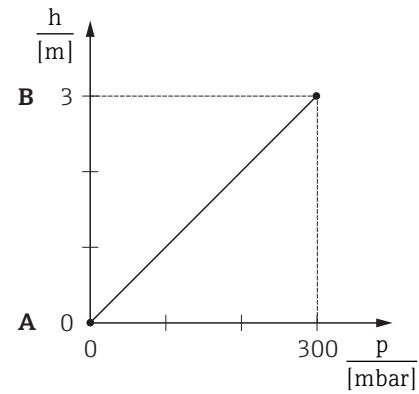

A0017658

Fig. 41: Calibration with reference pressure – wet calibration

C See Table, Step 8.
 D See Table, Step 9.

1) Is only supported by host systems that permit write access to individual elements of the record.

Calibration without reference pressure – dry calibration

Example:

In this example, the volume in a tank should be measured in liters. The maximum volume of 1000 liters corresponds to a pressure of 450 mbar. The minimum volume of 0 liters corresponds to a pressure of 50 mbar since the device is mounted below the level lower-range value.

Prerequisite:

- The measured variable is in direct proportion to the pressure.
- This is a theoretical calibration i.e. the pressure and volume values for the lower and upper calibration point must be known.

⚠ CAUTION

Note Dependencies when setting parameters!

- ▶ The values entered for Empty calibration/LOW_LEVEL_EASY and Full calib./HIGH_LEVEL_EASY must be at least 1% apart for the "Level easy pressure" level mode. The value will be rejected, and a warning message displayed, if the values are too close together. Further limit values are not checked; i.e. the values entered must be appropriate for the sensor and the measuring task so that the measuring device can measure correctly.
- ▶ Due to the orientation of the device, there may be a shift in the measured value, i.e. when the container is empty, the Primary Value/PRIMARY_VALUE parameter does not display zero.
→ For information on how to perform position adjustment, see also → 144, "Pos. zero adjust/PRESSURE_1_ACCEPT_ZERO_INSTALL".

Description	
1	Deltabar M: Before configuring the device for your application, the pressure piping must be cleaned and filled with medium.
2	Open the Pressure Transducer Block and set the block mode to OOS.

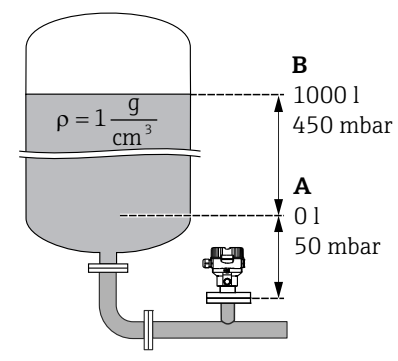

A0030030

Fig. 42: Calibration without reference pressure – dry calibration

A See Table, Step 9.
B See Table, Step 8.

Description	
3	Select the measuring mode if necessary: Select the "Level" option via the Primary Value Type/ PRIMARY_VALUE_TYPE parameter. Or:
4	Select the "Level" measuring mode via the Measuring mode/OPERATING_MODE parameter. Select the "In pressure" option via the Level selection/ LEVEL_ADJUSTMENT parameter.
5	Select the "l" (liter) option via the "Units Index" Scale Out/SCALE_OUT parameter. Or select a volume unit via the Unit before Lin./ OUT_UNIT_EASY parameter, here "l" for example.
6	Select the "Dry" option via the Calibration mode/ LEVEL_ADJUST_MODE_EASY parameter
7	By means of the Scale In/SCALE_IN record parameter, "Set URV/ E_PRESSURE_UPPER_RANGE_VALUE" elements, enter a pressure value, here 450 mbar for example, or enter a pressure via the Full pressure/ HIGH_LEVEL_PRESSURE_EASY parameter, here 450 mbar for example.
8	By means of the Scale In/SCALE_IN record parameter, "Set LRV/ E_PRESSURE_LOWER_RANGE_VALUE", enter a pressure value, here 50 mbar for example, or enter a pressure via the Empty pressure/ LOW_LEVEL_PRESSURE_EASY parameter, here 50 mbar for example.
9	By means of the Scale Out/SCALE_OUT record parameter, "EU at 100%/ E_ENGINEERING_UNIT_100_PERCENT" elements, enter the tank volume, here 1000 l for example. Or enter a volume via the Full calib./ HIGH_LEVEL_EASY parameter, here 1000 l for example.
10	By means of the Scale Out/SCALE_OUT record parameter, "EU at 0%/ E_ENGINEERING_UNIT_0_PERCENT" elements, enter the tank volume, here 0 l for example. Or enter a volume via the Empty calibration/ LOW_LEVEL_EASY parameter, here 0 l for example.
11	Set the Pressure Transducer Block to the "Auto" block mode.
12	If necessary, configure Channel/CHANNEL (→ 211), Linearization Type/L_TYPE (→ 212), Transducer Scale/XD_SCALE (→ 210) and Output Scale/OUT_SCALE (→ 211) parameters by means of the Analog Input Block.

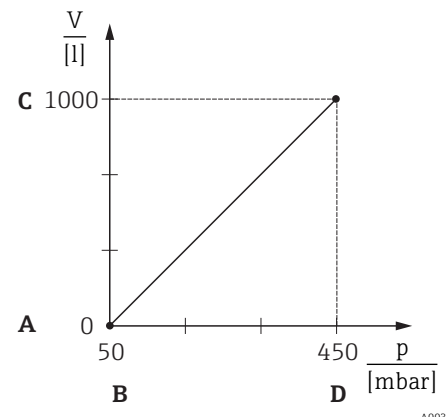

Fig. 43: Calibration with reference pressure – wet calibration

- E See Table, Step 6.
- F See Table, Step 7.
- G See Table, Step 8.
- H See Table, Step 9.

A0031028

9.7.4 "In height" level selection

Calibration with reference pressure – wet calibration

Example:

In this example, the volume in a tank should be measured in liters. The maximum volume of 1000 liters corresponds to a level of 4.5 m. The minimum volume of 0 liters corresponds to a level of 0.5 m since the device is mounted below the level lower-range value. The density of the medium is 1 g/cm³.

Prerequisite:

- The measured variable is in direct proportion to the pressure.
- The tank can be filled and emptied.

⚠ CAUTION

Note Dependencies when setting parameters!

- ▶ The values entered for Empty calibration/LOW_LEVEL_EASY and Full calib./HIGH_LEVEL_EASY must be at least 1% apart for the "Level easy pressure" level mode. The value will be rejected, and a warning message displayed, if the values are too close together. Further limit values are not checked; i.e. the values entered must be appropriate for the sensor and the measuring task so that the measuring device can measure correctly.
- ▶ Due to the orientation of the device, there may be a shift in the measured value, i.e. when the container is empty, the Primary Value/PRIMARY_VALUE parameter does not display zero.
→ For information on how to perform position adjustment, see also → 144, "Pos. zero adjust/PRESSURE_1_ACCEPT_ZERO_INSTALL".

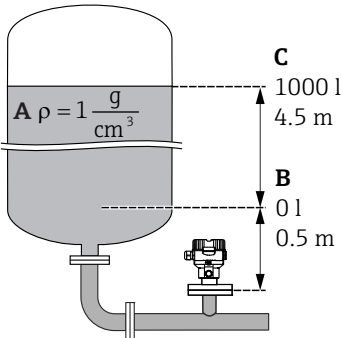
	Description	
1	Deltabar M: Before configuring the device for your application, the pressure piping must be cleaned and filled with medium.	 <p data-bbox="1045 1512 1468 1556">Fig. 44: Calibration with reference pressure - wet calibration</p> <p data-bbox="1045 1568 1244 1635">A See Table, step 8. B See Table, step 10. C See Table, step 12.</p> <p data-bbox="1476 1489 1532 1512">A0031027</p>
2	Open the Pressure Transducer Block and set the block mode to OOS.	
3	Select the measuring mode if necessary: Select the "Level height" option via the Primary Value Type/PRIMARY_VALUE_TYPE parameter. Or:	
4	Select the "Level" measuring mode via the Measuring mode/OPERATING_MODE parameter. Select the "In height" option via the Level selection/LEVEL_ADJUSTMENT parameter.	
5	Select the "l" (liter) option via the "Units index" Scale Out/SCALE_OUT parameter, or select a volume unit via the Unit before Lin./OUT_UNIT_EASY parameter, here "l" for example.	
6	Select a height unit by means of the Height unit/HEIGHT_UNIT_EASY parameter, here "m" for example.	
7	Select the "Wet" option by means of the Calibration mode/LEVEL_ADJUST_MODE_EASY parameter.	
8	Enter a density by means of the Adjust density/LEVEL_ADJUST_DENSITY_EASY parameter, here "1" g/cm ³ for example.	
9	Fill the container up to the lower level point. The associated level value can be viewed by means of the Meas. level/MEASURED_ACTUAL_LEVEL_EASY parameter.	

Description	
10	By means of the Empty calibration/ LOW_LEVEL_EASY parameter, enter a value, here 0 "I" for example.
11	Fill the container up to the upper level point. The associated level value can be viewed by means of the Meas. level/ MEASURED_ACTUAL_LEVEL_EASY parameter.
12	By means of the Full calib./HIGH_LEVEL_EASY parameter, enter a value, here 1000 "I" for example.
13	Set the Pressure Transducer Block to the "Auto" block mode.
14	If necessary, configure the Channel/CHANNEL (→ 211), Linearization Type/L_TYPE (→ 212), Transducer Scale/XD_SCALE (→ 210) and Output Scale/OUT_SCALE (→ 211) parameters by means of the Analog Input Block.

A
 $\rho = 1 \frac{\text{g}}{\text{cm}^3}$

B

C

A0031029

Fig. 45: Calibration with reference pressure - wet calibration

A See Table, step 8.
B See Table, step 10.
C See Table, step 12.

Calibration without reference pressure – dry calibration

Example:

In this example, the volume in a tank should be measured in liters. The maximum volume of 1000 liters corresponds to a level of 4.5 m. The minimum volume of 0 liters corresponds to a level of 0.5 m since the device is mounted below the level lower-range value. The density of the medium is 1 g/cm³.

Prerequisite:

- The measured variable is in direct proportion to the pressure.
- This is a theoretical calibration i.e. the height and volume values for the lower and upper calibration point must be known.

⚠ CAUTION

Note Dependencies when setting parameters!

- ▶ The values entered for Empty calibration/LOW_LEVEL_EASY and Full calib./HIGH_LEVEL_EASY must be at least 1 % apart for the "Level easy pressure" level mode. The value will be rejected, and a warning message displayed, if the values are too close together. Further limit values are not checked; i.e. the values entered must be appropriate for the sensor and the measuring task so that the measuring device can measure correctly.
- ▶ Due to the orientation of the device, there may be a shift in the measured value, i.e. when the container is empty, the Primary Value/PRIMARY_VALUE parameter does not display zero.
→ For information on how to perform position adjustment, see also → 144, "Pos. zero adjust/PRESSURE_1_ACCEPT_ZERO_INSTALL".

Description	
1	Deltabar M: Before configuring the device for your application, the pressure piping must be cleaned and filled with medium.
2	Open the Pressure Transducer Block and set the block mode to OOS.
3	Select the measuring mode if necessary: Select the "Level height" option via the Primary Value Type/PRIMARY_VALUE_TYPE parameter. Or:
4	Select the "Level" measuring mode via the Measuring mode/OPERATING_MODE parameter. Select the "In height" option via the Level selection/LEVEL_ADJUSTMENT parameter.
5	By means of the Unit before Lin./OUT_UNIT_EASY parameter, select a volume unit, here "l" for example.
6	Select a height unit by means of the Height unit/HEIGHT_UNIT_EASY parameter, here "m" for example.
7	Select the "Dry" option via the Calibration mode/LEVEL_ADJUST_MODE_EASY parameter
8	By means of the Adjust density/LEVEL_ADJUST_DENSITY_EASY parameter, enter a density, here "1" g/cm ³ for example.
9	By means of the Empty calibration/LOW_LEVEL_EASY parameter, enter a volume, here 0 l for example.
10	By means of the Empty height/LEVEL_OFFSET_EASY parameter, enter a height, here 0.5 m for example.
11	By means of the Full calib./HIGH_LEVEL_EASY parameter, enter a volume, here 1000 l for example.

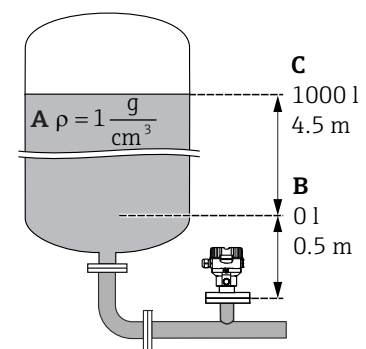

Fig. 46: Calibration without reference pressure – dry calibration

- A See Table, step 8.
- B See Table, steps 10 and 11.
- C See Table, steps 12 and 13.

Description	
12	By means of the Full height/ LEVEL_100_PERCENT_EASY parameter, enter a height, here 4.5 m for example.
13	Set the Pressure Transducer Block to the "Auto" block mode.
14	If necessary, configure the Channel/CHANNEL (→ 211), Linearization Type/L_TYPE (→ 212), Transducer Scale/XD_SCALE (→ 210) and Output Scale/OUT_SCALE (→ 211) parameters by means of the Analog Input Block.

A $\rho = 1 \frac{\text{g}}{\text{cm}^3}$

B

C

D

E

A0031066

Fig. 47: Calibration without reference pressure – dry calibration

- A** See Table, step 8.
- B** See Table, step 9.
- C** See Table, step 10.
- D** See Table, step 11.
- E** See Table, step 12.

9.8 Flow measurement (Deltabar M)

In this chapter the parameter text as well as the parameter name are indicated. In FF configuration programs only the parameter text is displayed (exception: in the NI-FBUS configurator you can select if the parameter text or the parameter name is displayed).

Example:

Parameter text	Parameter name
Linearization	LINEARIZATION

9.8.1 Adjustment

Example:

In this example, a volume flow should be measured in m³/h.



- The "Flow measurement" measuring mode is only available for the Deltabar M differential pressure transmitter.
- For a description of the parameters mentioned, see
 - → 178, Pressure Transducer Block.
 - → 208, Analog Input Block.

Description	
1	Before configuring the device for your application, the pressure piping must be cleaned and the device filled with medium.
2	Open the Pressure Transducer Block and DP_FLOW Block and set the block mode to OOS.
3	Select the measuring mode if necessary: <ul style="list-style-type: none"> ■ Select the "Flow" option via the Primary Value Type/PRIMARY_VALUE_TYPE parameter.
4	By means of the Press. eng. unit/CAL_UNIT parameter or via Scale In/SCALE_IN, select a pressure unit, here mbar for example.
5	Via the DP_FLOW Block: Select the "Volume operat. cond." option via the Flow meas. type/FLOW_TYPE parameter.
6	Via the DP_FLOW Block: By means of the Flow unit/FLOW_UNIT parameter, select a flow unit, here m ³ /h for example, or via the Pressure Transducer Block: By means of the Scale In/SCALE_IN record parameter, select the "Press. eng. unit/PRESSURE_1_UNIT" element.
7	Via the DP_FLOW Block: By means of the Flow Max/MAX_FLOW parameter, select the EU_100 element or via the Pressure Transducer Block: By means of the Scale Out/SCALE_OUT record parameter, select the "EU at 100% / E_ENGINEERING_UNIT_100_PERCENT" element. Enter the maximum flow value of the primary device, here 6000 m ³ /h for example. See also the layout sheet of the primary device.

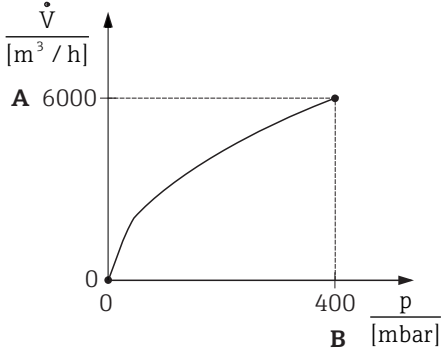

Fig. 48: Adjustment flow measurement

A See Table, step 7.
B See Table, step 8.

A0031382

Description	
8	<p>Via the DP_FLOW Block: Select via the Max. press. flow/ FLOW_MAX_PRESSURE parameter or via the Pressure Transducer Block: By means of the Scal In/SCALE_IN record parameter, select the "Set URV/ E_PRESSURE_UPPER_RANGE_VALUE" element.</p> <p>Enter the maximum pressure, here 400 mbar for example. See also the layout sheet of the primary device.</p>
9	Set the Pressure Transducer Block and DP_FLOW Block to the "Auto" block mode.
10	If necessary, configure the Channel/CHANNEL (→ 211), Linearization Type/L_TYPE (→ 212), Transducer Scale/XD_SCALE (→ 210) and Output Scale/OUT_SCALE (→ 211) parameters by means of the Analog Input Block.
11	Result: The device is configured for flow measurement.

⚠ CAUTION

Note Dependencies when setting parameters!

- ▶ By means of the Flow meas. type/FLOW_TYPE (→ 196) parameter, you can choose between the following flow types:
 - Volume process cond. (volume under operating conditions)
 - Gas norm. cond. (norm volume under norm conditions in Europe: 1013.25 mbar and 273.15 K (0 °C))
 - Gas std. cond. (standard volume under standard conditions in USA: 1013.25 mbar (14.7 psi) and 288.15 K (15 °C/59 °F))
 - Mass p. cond. (mass under operating conditions)
- ▶ The unit selected via the Flow unit/FLOW_UNIT (→ 197) parameter must be appropriate for the chosen flow type (Flow meas. type/FLOW_TYPE, → 196).
- ▶ In the lower measuring range, small flow quantities (creepages) can lead to large fluctuations in the measured value. By means of the Set. L. Fl. Cut-off/ CREEP_FLOW_SUPPRESSION_OFF_THRES (→ 198) parameter, you can configure a low flow cut off.

9.8.2 Totalizer

Example:

In this example, the volume flow should be totalized and displayed in the unit m^3E^3 . Negative flows should be added to the flow rate.



- For a description of the parameters mentioned, see
 - → [195](#), DP_FLOW Transducer Block
 - → [208](#), Analog Input Block.
- Totalizer 1 can be reset. Totalizer 2 cannot be reset.

	Description
1	Calibrate the device in accordance with Section 9.8.1.
2	Open the DP_FLOW Transducer Block and set the block mode to OOS.
3	By means of the Eng. unit total. 1/TOTALIZER_1_UNIT parameter, select a flow unit, here m^3E^3 for example.
4	By means of the Totalizer 1 mode/TOTALIZER_1_MODE parameter, specify the totalizing mode for negative flows, here the "Only negative flow" option for example.
5	Use the Reset Totalizer 1/TOTALIZER_1_RESET parameter to reset to zero.
6	Result: The Totalizer 1/TOTALIZER_1_STRING_VALUE record parameter, 1/E_TOTALIZER_1_FLOAT totalizer element displays the totalized volume flow.
7	Set the DP_FLOW Block to "Auto".



You can use the Display mode/DISPLAY_MAIN_LINE_1_CONTENT parameter (→ [202](#)) to specify which measured value should be displayed on the local operation.

Resetting totalizer 1 automatically

By means the Analog Alarm Block

With the aid of the Analog Alarm and Discrete Output Block, totalizer 1 in the DP_Flow Transducer Block can be reset automatically.

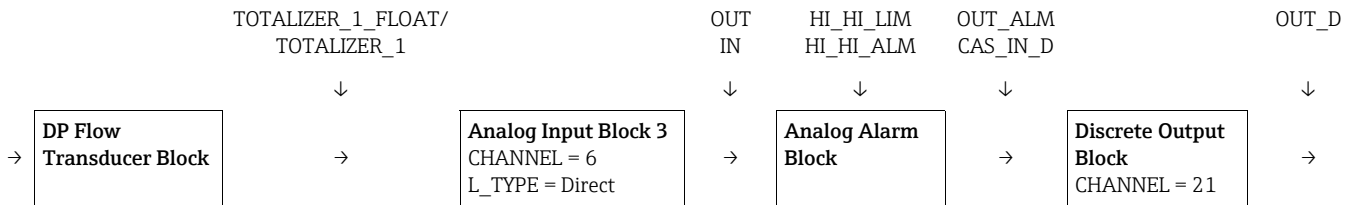

The DP_FLOW Transducer Block is connected to an Analog Input Block by means of the Channel/CHANNEL parameter (Channel/CHANNEL = 6). In the Analog Alarm Block the High High Limit/HI_HI_LIM parameter is used to set a limit value at which the totalizer should be reset to zero. As soon as this limit value is overshoot, the Analog Alarm Block transmits an alarm value to the downstream Discrete Output Block. The latter changes its output from 0 to 1 and thus resets the totalizer in the DP_FLOW Transducer Block to 0. The output of the Analog Alarm Block changes back to 0.

By means the Analog Input Block

With the aid of Analog Input and Discrete Output Block, totalizer 1 in the DP_Flow Transducer Block can be reset automatically.

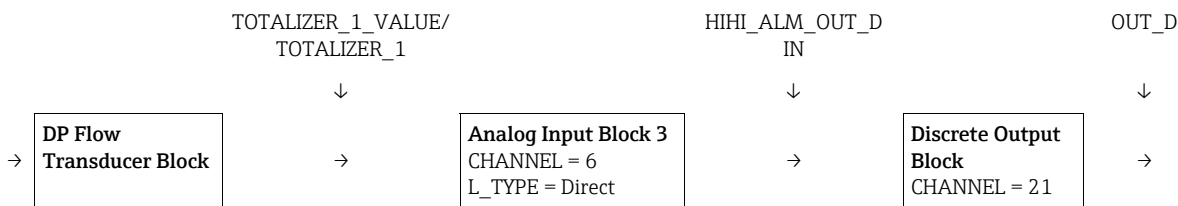

The DP_FLOW Transducer Block is connected to an Analog Input Block by means of the Channel/CHANNEL parameter (Channel/CHANNEL = 6). In the Analog Input Block the High High Limit/HI_HI_LIM parameter is used to set a limit value at which the totalizer should be reset to zero. As soon as this limit value is overshoot, the Analog Input Block transmits an alarm value to the downstream Discrete Output Block. The latter changes its output from 0 to 1 and thus resets the totalizer in the DP_FLOW Transducer Block to 0. The output of the Analog Input Block changes back to 0.

9.9 Linearization

9.9.1 Manual entry of the linearization table

Example:

In this example, the volume in a tank with a conical outlet should be measured in m³.

Prerequisite:

- This is a theoretical calibration, i.e. the points for the linearization table are known.
- The "Level" measuring mode has been selected. The Primary Value Type/ PRIMARY_VALUE_TYPE parameter is set to "Level" or "Level height".
- A level calibration has been performed.



For a description of the parameters mentioned, Section 8.11 "Description of parameters".

Description	
1	Open the Pressure Transducer Block and set the block mode to OOS.
2	Select the "Manual input" option via the Lin. mode/ LINEARIZATION_TABLE_MODE parameter.
3	Select by means of the Unit after lin./ AFTER_LINEARIZATION_UNIT parameter, m ³ for example.
4	By means of the Lin tab index 01/ LIN_TAB_X_Y_VALUE_1 to Lin tab index 32/ LIN_TAB_X_Y_VALUE_32 parameters, select the desired X-values and Y-values.
5	Once all the points have been entered in the table, select the "Activate table" option via the "Lin. mode/ LINEARIZATION_TABLE_MODE" parameter.
6	Set the Pressure Transducer Block to the "Auto" block mode.
7	Result: The measured value after linearization is displayed.

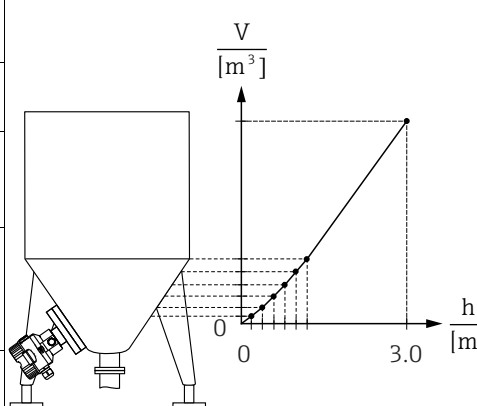
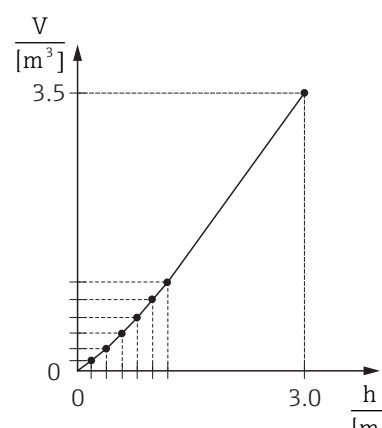
A0030032



Error message F510 "Linearization" and alarm current appears as long as the table is being entered and until the table is activated.

9.9.2 Semi-automatic entry of the linearization table

Example:

In this example, the volume in a tank with a conical outlet should be measured in m³.

Prerequisite:

- The tank can be filled or emptied. The linearization characteristic must rise continuously.
- The "Level" measuring mode has been selected. The Primary Value Type/ PRIMARY_VALUE_TYPE parameter is set to "Level" or "Level height".



For a description of the parameters mentioned → Chap. 8.11 "Description of parameters".

Description	
1	Open the Pressure Transducer Block and set the block mode to OOS.
2	Select the "Semi-auto. entry" option via the "Lin. mode/LINEARIZATION_TABLE_MODE" parameter.
3	By means of the Unit after lin./ AFTER_LINEARIZATION_UNIT parameter, select the volume unit/mass unit, e.g. m ³ .
4	Fill the tank to the height of the 1st point.
5	By means of the Line numb./LINEARIZATION_TABLE_INDEX parameter, enter the number of the point in the table. The actual level is displayed via the X-value:/ TB_LINEARIZATION_TABLE_X_VALUE parameter. Using the Y-value:/TB_LINEARIZATION_TABLE_Y_VALUE parameter, enter the associated volume value, here 0 m ³ for example, and confirm the value.
6	Enter the next point as explained in Step 5.
7	Once all the points have been entered in the table, select the "Activate table" option via the "Lin. mode/ LINEARIZATION_TABLE_MODE" parameter.
8	Set the Pressure Transducer Block to the "Auto" block mode.
9	Result: The measured value after linearization is displayed.

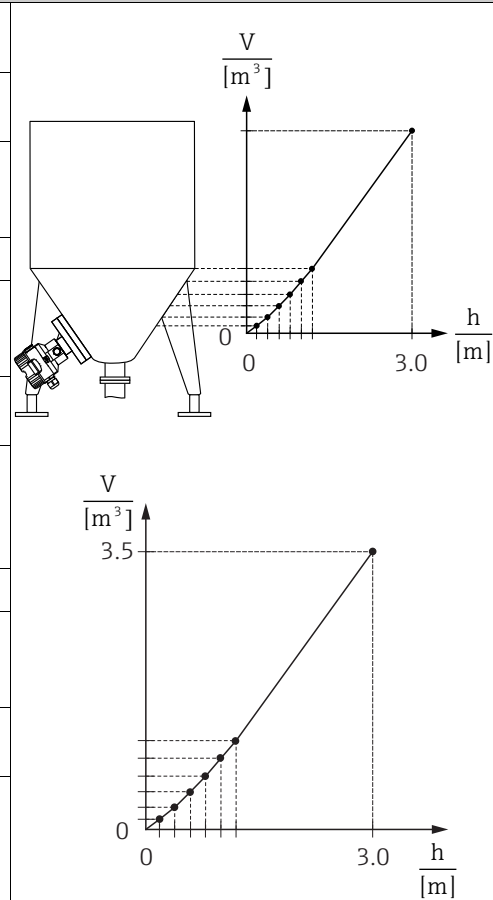

Error message F510 "Linearization" appears as long as the table is being entered and until the table is activated.

9.10 Electrical differential pressure measurement with gauge pressure sensors (Cerabar M or Deltapilot M)

Example:

In the example given, two Cerabar M or Deltapilot M devices (each with a gauge pressure sensor) are interconnected. The pressure difference can thus be measured using two independent Cerabar M or Deltapilot M devices.



For a description of the parameters mentioned → Chap. 8.11 "Description of parameters".

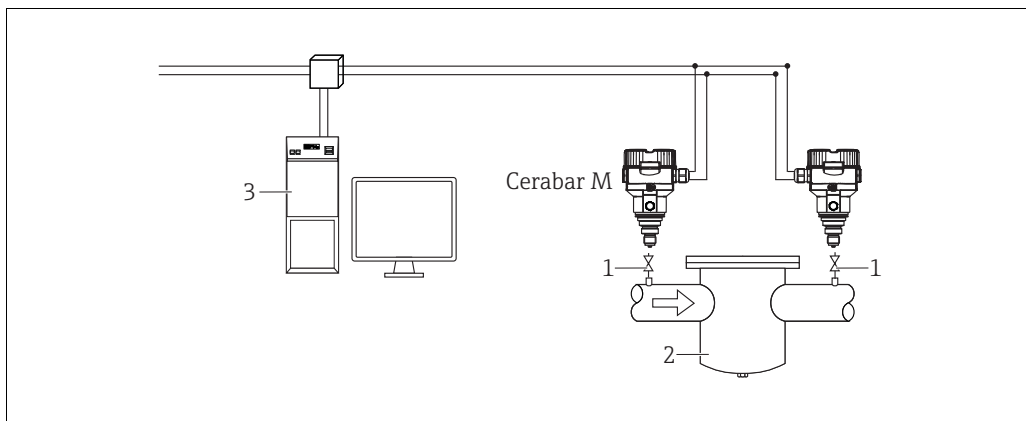

Fig. 49:
 1 Shut-off valves
 2 e.g. filter
 3 FF HOST System

1.)

Description Adjustment of the Cerabar M/Deltapilot M on the high-pressure side in the Pressure Transducer Block	
1	Open the Pressure Transducer Block and set the block mode to OOS.
2	Select the "Pressure" measuring mode via the Measuring mode/OPERATING_MODE or Primary Value Type/PRIMARY_VALUE_TYPE parameter.
3	Select a pressure unit via the Calibration Units/CAL_UNIT parameter, here "mbar" for example.
4	The Cerabar M/Deltapilot M is unpressurized, perform position adjustment, see → 73.
5	Set the Pressure Transducer Block to the "Auto" block mode. If necessary, configure the Channel/CHANNEL (→ 211), Linearization Type/L_TYPE (→ 212), Transducer Scale/XD_SCALE (→ 210) and Output Scale/OUT_SCALE (→ 211) parameters by means of the Analog Input Block.

2.)

The Analog Input Block output of the high-pressure side of the device has to be connected to one of the 4 inputs of the Input Selector Block on the low-pressure side of the device (here Input1 for example).

This configuration has to be written to the devices.

Both blocks must be set to the Auto mode.

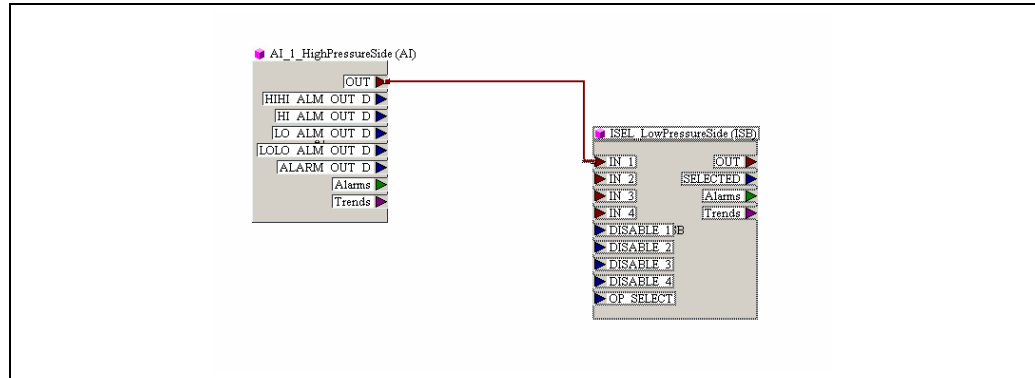

A0030416

3.)

	Description Adjustment of the Cerabar M/Deltapilot M on the low-pressure side (the differential is generated in this device) in the Pressure Transducer Block
1	Open the Pressure Transducer Block and set the block mode to OOS.
2	Select the "Pressure" measuring mode via the Measuring mode/OPERATING_MODE or Primary Value Type/PRIMARY_VALUE_TYPE parameter.
3	Select a pressure unit via the Calibration Units/CAL_UNIT parameter, here "mbar" for example.
4	The Cerabar M/Deltapilot M is unpressurized, perform position adjustment, see → 73.
5	Select the input via the E.delta p selec./E_DELTA_P_INPUT_SELECTOR parameter (here Input1 for example).
6	Select the desired unit via the E.delta p unit/E_DELTA_P_INPUT_UNIT parameter (here mbar for example).
7	Select the external value mode via the Electr. delta P/ELECTRIC_DELTA_P_CONTROL parameter.
8	The current measured values and status information returned by the device on the high-pressure side can be read via the E. delta p value/E_DELTA_P_VALUE and "E. delta p status/E_DELTA_P_STATUS" parameters.
9	Set the Pressure Transducer Block to the "Auto" block mode. If necessary, configure the Channel/CHANNEL (→ 211), Linearization Type/L_TYPE (→ 212), Transducer Scale/XD_SCALE (→ 210) and Output Scale/OUT_SCALE (→ 211) parameters by means of the Analog Input Block.

⚠ CAUTION**Note Dependencies when setting parameters!**

- ▶ It is not permitted to reverse the assignment of the measuring points to the direction of communication.
- ▶ The measured value of the transmitting device must always be greater than the measured value of the receiving device (via the "Electr. delta P" function).
- ▶ Adjustments that result in an offset of the pressure values (e.g. position adjustment, trim) must always be performed in accordance with the individual sensor and its orientation, irrespective of the "Electr. Delta P" application. Other settings result in non-permitted use of the "Electr. Delta P" function and can lead to incorrect measured values.

9.11 Displaying external values on the onsite display via FF bus

The inputs of the Input Selector Block are used to display device external values on the onsite display via the FF bus.

Example:

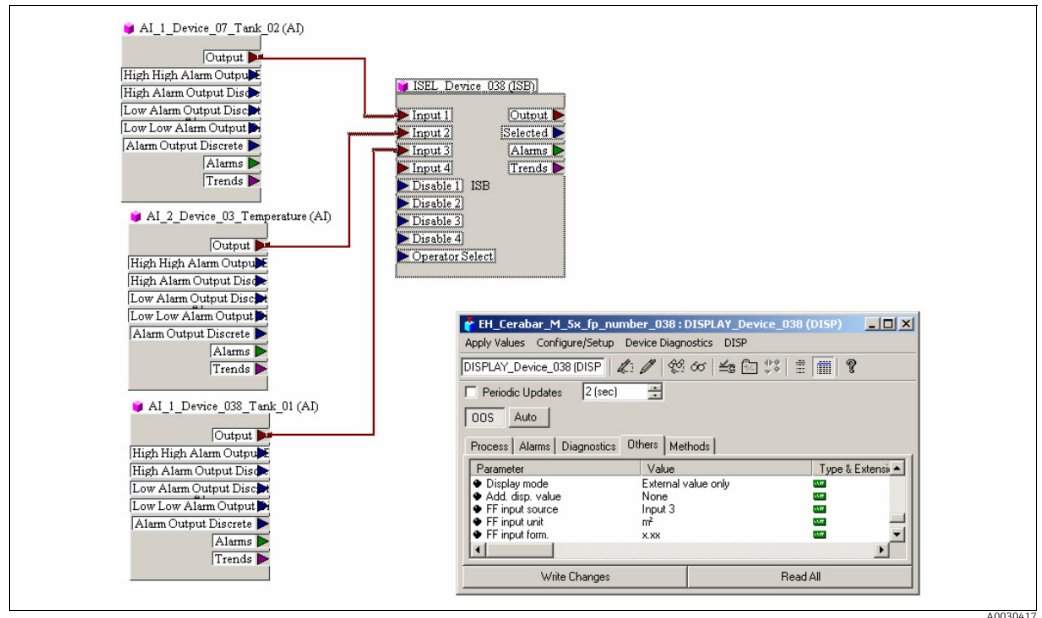

Fig. 50: Connection example

⚠ CAUTION

Note Dependencies when setting parameters!

- ▶ The desired value must be connected to one of the four inputs of the Input Selector Block, and this configuration must be written into the device. Only the inputs of the Input Selector Block are used for functionality. Output and status are not taken into account

	Description
1	Open the Display Block.
2	Select the "External value only" option via the Display mode/DISPLAY_MAIN_LINE_1_CONTENT parameter.
3	Select an input via the FF input source/DISPLAY_INPUT_SELECTOR parameter, here "Input 3" for example.
4	Via the FF input unit/DISPLAY_INPUT_UNIT parameter, select the appropriate unit, as only values and status information are transmitted with FF, here "m ² " for example.
5	Via the FF input form./DISPLAY_INPUT_FORMAT parameter, select the desired format for the onsite display, here "x.xx" for example.

9.12 Description of parameters

In this chapter the parameter text as well as the parameter name are indicated. In FF configuration programs only the parameter text is displayed (exception: in the NI-FBUS configurator you can select if the parameter text or the parameter name is displayed).

Example:

Parameter text	Parameter name
Linearization	LINEARIZATION



- With FOUNDATION Fieldbus, all the device parameters are categorized according to their functional properties and task and are assigned to the Resource Block, the Transducer Blocks and the function blocks. The parameters of the Resource Block, the Transducer Blocks and the Analog Input Block are described in this section. For a parameter description of the other function blocks, such as the PID or Discrete Output Block, see Operating Instructions BA00013S "FOUNDATION Fieldbus Overview" or the FOUNDATION Fieldbus specification.
- Some parameters are only relevant if other parameters are appropriately configured.

9.12.1 Block model

The Cerabar M/Deltabar M/Deltapilot M has the following blocks:

- Resource Block (device block)
- Transducer Blocks
 - Pressure Transducer Block
This block supplies the output variables Primary Value/PRIMARY_VALUE and Secondary Value/SECONDARY_VALUE. It contains all the parameters to configure the measuring device for the measuring task such as measuring mode selection, linearization function and unit selection.
 - DP_FLOW Transducer Block (only Deltabar M)
This block supplies the output variable "Totalizer 1 /TOTALIZER_1_FLOAT" and "Totalizer 2 /TOTALIZER_2_FLOAT". It contains all the parameters that are needed to configure the flow and this totalizer.
 - Diagnostic Transducer Block
This Block returns error messages as output variables. It contains the simulation function for the Pressure Transducer Block, parameters to configure the alarm response and the user limits for pressure and temperature.
 - Display Transducer Block
This Block does not return any output variables. It contains all the parameters for configuring the onsite display, such as Language/DISPLAY_LANGUAGE.
- Function blocks
 - 2 Analog Input Blocks (AI)
 - Discrete Output Block (DO)
 - PID Block (PID)
 - Arithmetic Block (ARB)
 - Input Selector Block (ISB)
 - Integrator Block (IT)
 - Discrete Input Block (DI)

Block configuration when device is delivered

The block model shown below illustrates the block configuration when the device is delivered.

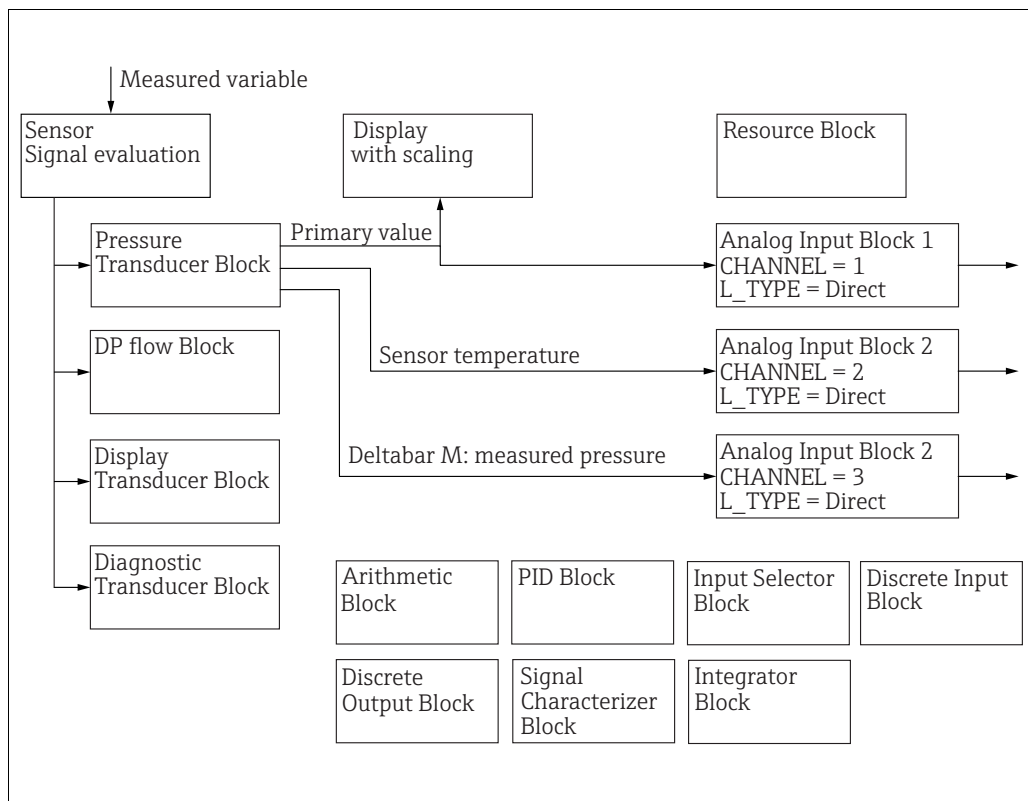

Fig. 51: Block configuration when device is delivered

Cerabar M/Deltapilot M

The Pressure Transducer Block returns the primary value (measured value) and the secondary value (sensor temperature). The Primary Value and Secondary Value are each transmitted to an Analog Input Block via the Channel/CHANNEL parameter (→ 211, Channel/CHANNEL parameter description). The Discrete Output, Discrete Input, PID, Arithmetic, Input Selector and Integrator are not connected in the as-delivered state. (IT, DI).

Deltabar M

The Pressure Transducer Block returns the Primary Value (measured value) and the Secondary Value (max. pressure). In the DP_FLOW Transducer Block, the flow is totalized in the "Flow" measuring mode and output by means of the Totalizer 1/TOTALIZER_1 and Totalizer 2/TOTALIZER_2 record parameter. The Primary Value, Secondary Value and Totalizer 1 and 2 values are each transmitted to an Analog Input Block via the Channel/CHANNEL parameter (→ 211, Channel/CHANNEL parameter description). The Discrete Output, PID, Arithmetic and Input Selector are not connected in the as-delivered state. (IT, DI)

CAUTION

Note Dependencies when setting parameters!

- ▶ Please note that links between the blocks are deleted and the FF parameters are reset to the default values following a reset by means of the Restart/RESTART parameter in the Resource Block, "Default" option.

9.12.2 Resource Block

Resource Block - standard parameters	
Parameter	Description
Static Revision/ST_REV Display Index: 1 Data type: unsigned16 Access: read only	Displays the counter for static parameters of the Resource Block. The counter is incremented by one with each change of a static parameter of the Resource Block. The counter counts up to 65535 and then starts again at zero.
Tag Description/ TAG_DESC Entry Index: 2 Data type: octet string Access: wr for Auto, OOS	Enter a description for the related block or the measuring point e.g. TAG number (max. 32 alphanumeric characters).
Strategy/STRATEGY Entry Index: 3 Data type: unsigned16 Access: wr for Auto, OOS	Enter user-specific value for grouping and thus faster evaluation of the blocks. Grouping takes place by entering the same numerical value for the Strategy/STRATEGY parameter of the block in question. This value is neither checked nor processed by the Resource Block. Input range: 0...65535 Factory setting: 0
Alert Key/ALERT_KEY Entry Index: 4 Data type: unsigned8 Access: wr for Auto, OOS	Enter the identification number for the measuring device or for each individual block. The control level uses this identification number to sort alarm and event messages and initiate other processing steps. Input range: 1...255 Factory setting: 0
Block Mode/ MODE_BLK Selection, display Index: 5 Data type: DS-69 Access: wr for Auto, OOS	The Block Mode/MODE_BLK parameter is a structured parameter consisting of four elements. The Resource Block supports the "Auto" (automatic) and OOS (out of service) modes. TARGET <ul style="list-style-type: none"> ▪ Change the block mode. ACTUAL <ul style="list-style-type: none"> ▪ Displays the current block mode. PERMITTED <ul style="list-style-type: none"> ▪ Displays the modes supported by the block. NORMAL <ul style="list-style-type: none"> ▪ Displays the block mode during standard operation.
Block Error/ BLOCK_ERR Display Index: 6 Data type: bit string Access: read only	Displays the active block error. Possibilities: <ul style="list-style-type: none"> ▪ Out of service: the Resource Block is in the OOS block mode. ▪ Simulation active: DIP switch 3 "Simulation" on the electronic insert is set to "on", i.e. simulation is possible.
Resource State/ RS_STATE Display Index: 7 Data type: unsigned8 Access: read only	Displays the current status of the Resource Block. Possibilities: <ul style="list-style-type: none"> ▪ Standby: The Resource Block is in the OOS mode (out-of-service). The remaining blocks cannot be executed. ▪ Online linking: The configured links between the function blocks have not yet been established. ▪ Online: Standard block mode, the Resource Block operates in the auto mode. All the configured links between the function blocks have been established. If a link is missing, this parameter displays the "Online linking" status.

Resource Block - standard parameters	
Parameter	Description
Test Read Write/ TEST_RW Display Index: 8 Data type: DS-85 Access: wr for Auto, OOS	This parameter is required only for the FF conformance test and has no meaning in normal operation.
DD Resource/ DD_RESOURCE Display Index: 9 Data type: visible string Access: read only	String that indicates the tag of the resource that contains the device description for this resource.
Manufacturer ID/ MANUFAC_ID Display Index: 10 Data type: unsigned32 Access: read only	Displays the manufacturer's ID number. Endress+Hauser: 0 x 452B48 (decimal: 4533064)
Device Type/DEV_TYPE Display Index: 11 Data type: unsigned16 Access: read only	Displays the device ID number. Deltabar M 5x: hexadecimal: 0x1021, decimal: 4129. Cerabar M 5x: hexadecimal: 0x1019, decimal: 4121. Deltapilot M 5x: hexadecimal: 0x1023, decimal: 4131.
Device Revision/ DEV_REV Display Index: 12 Data type: unsigned8 Access: read only	Displays the revision number of the device.
DD Revision/DD_REV Display Index: 13 Data type: unsigned8 Access: read only	Displays the revision number of the device description (DD).
Grant Deny/ GRANT_DENY Entry Index: 14 Data type: DS-70 Access: wr for Auto, OOS	Grant or restrict access authorization for a fieldbus host system to the device. This parameter is not evaluated by Deltabar M 5x, Cerabar M 5x and Deltapilot M 5x.
Hard Types/ HARD_TYPES Display Index: 15 Data type: bit string Access: read only	Displays the input and output signal type.

Resource Block - standard parameters	
Parameter	Description
Restart/RESTART Options Index: 16 Data type: unsigned8 Access: r, w	Select the reset mode. Options: <ul style="list-style-type: none"> ▪ ENP_RESTART: A restart is needed to accept the ENP configuration changes. ▪ Run: Standard operating mode ▪ Resource: This mode is not supported by Endress+Hauser. ▪ Defaults: The device data and the links of the function blocks are reset to the factory settings. The manufacturer-specific parameters of the Transducer Block are not reset to the factory settings. ▪ Processor: Warm start of device, processor restart. ▪ Factory: The links of the function blocks, all FF-specific and resettable manufacturer-specific parameters are reset to the factory setting. ▪ Customer settings (user reset): If a new sensor is connected, sensor-specific parameters are adapted to suit the new sensor. Resets the parameters to the as-delivered state apart from the TAG number, linearization table, entries in the operated hours counter, status history and format of the onsite display. The device is restarted. ▪ Measurement AP: not effects.
Features/FEATURES Display Index: 17 Data type: bit string Access: read only	Displays the additional functions supported by the device: FEAT_REPORT FEAT_FAILSAFE FEAT_HARD_WR_LOCK FEAT_MVC → See also this table, Feature Selection/FEATURE_SEL parameter description.
Feature Selection/ FEATURE_SEL Entry Index: 18 Data type: bit string Access: wr for Auto, OOS	Select the additional device functions. The additional functions that the device supports are displayed in the Features/FEATURES parameter.
Cycle Type/ CYCLE_TYPE Display Index: 19 Data type: bit string Access: read only	Displays the block execution methods supported by the device. → See also this table, Cycle Selection/CYCLE_SEL parameter description.
Cycle Selection/ CYCLE_SEL Display Index: 20 Data type: bit string Access: wr for Auto, OOS	Displays the block execution method used by the fieldbus host system. The block execution method is selected by the fieldbus host system. Possibilities: <ul style="list-style-type: none"> ▪ Scheduled: cyclical block execution method ▪ Block execution: sequential block execution method
Minimum Cycle Time/ MIN_CYCLE_T Display Index: 21 Data type: unsigned32 Access: read only	Displays the shortest MACROCYCLE supported by the device. Factory setting: 3200 ¹ / ₃₂ ms (≅ 100 ms)
Memory Size/ MEMORY_SIZE Display Index: 22 Data type: unsigned16 Access: read only	Displays the available configuration memory in kilobytes. This parameter is not supported by Deltabar M 5x, Cerabar M 5x and Deltapilot M 5x.

Resource Block - standard parameters	
Parameter	Description
Nonvolatile Cycle Time/ NV_CYCLE_T Display Index: 23 Data type: unsigned32 Access: read only	Displays the time interval for which the dynamic device parameters are stored in the nonvolatile memory. 5760000 1/32 ms \cong 180s
Free Space/ FREE_SPACE Display Index: 24 Data type: float Access: read only	Displays the system memory (in percent) available for the execution of further function blocks. This parameter is not supported by Deltabar M, Cerabar M and Deltapilot M.
Free Time/FREE_TIME Display Index: 25 Data type: float Access: read only	Displays the free system time (in percent) available for the execution of further function blocks. This parameter is not supported by Deltabar M, Cerabar M and Deltapilot M.
Shed Remote Cascade/ SHED_RCAS Entry Index: 26 Data type: unsigned32 Access: wr for Auto, OOS	Enter the monitoring time for checking the connection between the fieldbus host system and the PID function block in the RCAS block mode. On expiry of this monitoring time the PID function block switches from the RCAS block mode to the block mode selected via the Shed Options/SHED_OPT parameter. Factory setting: 640000 1/32 ms
Shed Remote Out/ SHED_ROUT Entry Index: 27 Data type: unsigned32 Access: wr for Auto, OOS	Enter the monitoring time for checking the connection between the fieldbus host system and the PID function block in the ROUT block mode. On expiry of this monitoring time the PID function block switches from the ROUT block mode to the block mode selected via the Shed Options/SHED_OPT parameter. Factory setting: 640000 1/32 ms
Fault State/ FAULT_STATE Display Index: 28 Data type: unsigned8 Access: read only	Current status display of the fault state of the Discrete Output function block. Possibilities: <ul style="list-style-type: none"> ■ Uninitialized ■ Clear (fault state not active) ■ Active (fault state active)
Set Fault State/ SET_FSTATE Options Index: 29 Data type: unsigned8 Access: wr for Auto, OOS	Activate the fault state of the Discrete Output function block manually. → See also this table, Clear Fault State/CLR_FSTATE parameter description. Possibilities: <ul style="list-style-type: none"> ■ Uninitialized ■ Off ■ Set (the fault state is enabled)
Clear Fault State/ CLR_FSTATE Options Index: 30 Data type: unsigned8 Access: wr for Auto, OOS	Deactivate the fault state of the Discrete Output function block manually. → See also this table, Set Fault State/SET_FSTATE parameter description. Possibilities: <ul style="list-style-type: none"> ■ Uninitialized ■ Off ■ Clear (fault state is disabled)

Resource Block - standard parameters	
Parameter	Description
Max Notify/ MAX_NOTIFY Display Index: 31 Data type: unsigned8 Access: read only	Displays the number of event reports supported by the device that can exist unconfirmed at the same time. → See also this table, Limit Notify/LIM_NOTIFY parameter description.
Limit Notify/ LIM_NOTIFY Entry Index: 32 Data type: unsigned8 Access: wr for Auto, OOS	Enter the maximum possible number of event reports that can exist unconfirmed at the same time. This parameter is not evaluated by Deltabar M 5x, Cerabar M 5x and Deltapilot M 5x.
Confirm Time/ CONFIRM_TIME Entry Index: 33 Data type: unsigned32 Access: wr for Auto, OOS	Enter the confirmation time for the event report. If the device does not receive confirmation within this time, the event report is sent to the fieldbus host system again. Factory setting: 640000 ¹ / ₃₂ ms
Write Lock/ WRITE_LOCK Display Index: 34 Data type: unsigned8 Access: read only	Displays the status of DIP switch 1 on the electronic insert. You can lock or unlock parameters relevant to the measured value with DIP switch 1. If operation is locked by means of the Operator code/S_W_LOCK (→ 204) parameter, you can only unlock operation again by means of this parameter. Possibilities: <ul style="list-style-type: none"> ▪ Locked: Security locking switched on, i.e. the parameters cannot be written to. ▪ Not locked: Security locking switched off. Depending on the block mode in question, it is possible to write to the parameters (→ see Tables, "Parameter" column, access). Factory setting: Locked (locking switched on)
Update Event/ UPDATE_EVT Display Index: 35 Data type: DS-73 Access: read only	The Update Event/UPDATE_EVT parameter is a structured parameter consisting of five elements. UNACKNOWLEDGED <ul style="list-style-type: none"> ▪ This element is set to "Unacknowledged" as soon as a static parameter changes. UPDATE_STATE <ul style="list-style-type: none"> ▪ Indicates whether the change was reported. TIME_STAMP <ul style="list-style-type: none"> ▪ Displays the date and time when a static parameter was changed. STATIC_REVISION <ul style="list-style-type: none"> ▪ The revision counter is increased each time a static parameter is changed. RELATIVE_INDEX <ul style="list-style-type: none"> ▪ Displays the altered parameter in the form of the relative index. See also this Table, "Parameter, Index" column.

Resource Block - standard parameters	
Parameter	Description
Block Alarm/ BLOCK_ALM Display, selection Index: 36 Data type: DS-72 Access: wr for Auto, OOS	The Block Alarm/BLOCK_ALM parameter is a structured parameter consisting of five elements. UNACKNOWLEDGED <ul style="list-style-type: none"> ▪ If the "Deactivated" option was selected for the alarm that occurred by means of the Acknowledge Option/ACK_OPTION parameter, this alarm can only be acknowledged by means of this element. ALARM_STATE <ul style="list-style-type: none"> ▪ Use this function to display the current block condition with information on pending configuration, hardware or system errors. The following block alarm messages are possible with the Resource Block: <ul style="list-style-type: none"> - Simulate active - Out of service TIME_STAMP <ul style="list-style-type: none"> ▪ Displays the time when the alarm occurred. SUB_CODE <ul style="list-style-type: none"> ▪ Displays the reason why the alarm was reported. VALUE <ul style="list-style-type: none"> ▪ Displays the value of the corresponding parameter at the time the alarm was reported.
Alarm Summary/ ALARM_SUM Display, selection Index: 37 Data type: DS-74 Access: wr for Auto, OOS	The Alarm Summary/ALARM_SUM parameter is a structured parameter consisting of four elements. CURRENT <ul style="list-style-type: none"> ▪ Displays the current status of the process alarms in the Resource Block. The following alarms are possible: DiscAlm and BlockAlm. UNACKNOWLEDGED <ul style="list-style-type: none"> ▪ Displays the process alarms not confirmed. UNREPORTED <ul style="list-style-type: none"> ▪ Displays the process alarms not reported. DISABLED <ul style="list-style-type: none"> ▪ Possibility of deactivating process alarms.
Acknowledge Option/ ACK_OPTION Options Index: 38 Data type: bit string Access: wr for Auto, OOS	Use this parameter to specify the process alarm to be acknowledged automatically as soon as it is detected by the fieldbus host system. If the option is activated for a process alarm, this process alarm is acknowledged automatically by the fieldbus host system. Options: <ul style="list-style-type: none"> ▪ DiscAlm: write protection alarm ▪ BlockAlm: block alarm  <p>The message has to be acknowledged via the Block Alarm/BLOCK_ALM parameter, UNACKNOWLEDGE element for process alarms for which automatic confirmation is not active.</p> Factory setting: The option is not active for any process alarm, i.e. every process alarm message must be acknowledged manually.
Write Priority/ WRITE_PRI Entry Index: 39 Data type: unsigned8 Access: wr for Auto, OOS	If write protection is disabled, an alarm is issued. Use this parameter to specify the priority which should be assigned to this alarm. Input range: <ul style="list-style-type: none"> ▪ 0...15 ▪ 0: The alarm is suppressed. ▪ 15: Critical alarm with the highest priority.

Resource Block - standard parameters	
Parameter	Description
Write Alarm/ WRITE_ALM Display Index: 40 Data type: DS-72 Access: wr for Auto, OOS	<p>The Write Alarm/WRITE_ALM parameter is a structured parameter consisting of five elements.</p> <p>UNACKNOWLEDGED</p> <ul style="list-style-type: none"> ▪ If the "Deactivated" option was selected via the Acknowledge Option/ACK_OPTION parameter for the alarm that occurred, this alarm can only be acknowledged by means of this element. <p>ALARM_STATE</p> <ul style="list-style-type: none"> ▪ Displays the status of the write protection alarm. <p>TIME_STATE</p> <ul style="list-style-type: none"> ▪ Displays the time when the alarm occurred. <p>SUB_CODE</p> <ul style="list-style-type: none"> ▪ Displays the reason why the alarm was reported. <p>VALUE</p> <ul style="list-style-type: none"> ▪ Displays the value of the corresponding parameter at the time the alarm was reported.
ITK Version/ITK_VER Display Index: 41 Data type: unsigned16 Access: read only	<p>Displays the revision version (major revision number) of the interoperability test kit (ITK).</p> <p>Factory setting: 5</p>

Resource Block - Endress+Hauser parameters	
Parameter	Description
Device dialog/ DEVICE_DIALOG Display Index: 42 Data type: unsigned8 Access: read only	<p>If configuration is unsuitable, this parameter displays a message indicating that a configuration error is present. The message can indicate which parameter was incorrectly configured.</p>
Operator code/ S_W_LOCK Entry Index: 43 Data type: unsigned16 Access: wr for Auto, OOS	<p>Use this function to enter a code to lock or unlock operation.</p> <p>Options:</p> <ul style="list-style-type: none"> ▪ To lock: Enter a number ≠ the release code. ▪ To unlock: Enter the release code. <p></p> <p>The release code is "0" in the order configuration. Another release code can be defined in the Code definition/USER_S_W_UNLOCK parameter. If the user has forgotten the release code, it can be made visible again by entering the number sequence "5864".</p> <p>Factory setting: 0</p>
Lockstate/ STATUS_LOCKING Index: 44 Data type: unsigned8 Access: read only	<p>Displays the current locking status of the device or conditions that can lock the device (hardware locking, software locking).</p>
DIP switch/ SWITCH_STATUS_LIST Display Index: 45 Data type: unsigned8 Access: read only	<p>Displays the status of the active DIP switches.</p>

Resource Block - Endress+Hauser parameters	
Parameter	Description
Electr. serial no./ ELECTRONIC_SERIAL_NUMBER Display Index: 46 Data type: visible string Access: read only	Displays the serial number of the main electronics (11 alphanumeric characters).
Sci octet str/ SCI_OCTET_STRING Display Index: 47 Data type: visible string Access: wr for Auto, OOS	Internal service parameter.
Download select./ DOWNLOAD_OVERWRITE_SELECTION Options Index: 48 Data type: unsigned8 Access: wr for Auto, OOS	Selection of data records for the Upload/Download function in Fieldcare. Prerequisite: DIP switch 1, 3, 4 and 5 set to "OFF", DIP switch 2 set to "ON" (see picture in Chap. 6.2.1)). A download with the factory setting "Copy configuration" causes all parameters needed for a measurement to be downloaded. If the "Copy configuration" setting is changed, it takes effect only when a corresponding release code is entered into the parameter "Operator code/S_W_LOCK". Options: <ul style="list-style-type: none"> ▪ Copy configuration: With this option, general configuration parameters are overwritten except for serial number, order number, calibration, position adjustment, application, and tag information. ▪ Device replacement: With this option, general configuration parameters are overwritten except for serial number, order number, calibration, position adjustment, and PD tag. ▪ Electronics replacement: With this option, general configuration parameters are overwritten except for position adjustment.  The control strategy is not affected by a download. Selection of device replacement or electronics replacement takes effect only if a corresponding release code has been entered beforehand. Factory setting: Copy configuration
Code definition/ USER_S_W_UNLOCK Entry Index: 49 Data type: unsigned16 Access: wr for Auto, OOS	Use this function to enter a release code with which the device can be unlocked. User input: <ul style="list-style-type: none"> ▪ A number between 0 and 9999 Factory setting: 0
Capability level/ CAPABILITY_LEVEL Display Index: 50 Data type: unsigned8 Access: read only	This parameter is integrated into a device to indicate what capability level is supported by the device. Description: capability level supported by the device. A value of zero (0) indicates that the device does not support multiple capability levels. Factory setting: 1

Resource Block - Endress+Hauser parameters	
Parameter	Description
Compat. level/ COMPATIBILITY_LEVEL Display Index: 51 Data type: unsigned8 Access: read only	Indicates up to which specific device version the devices are compatible. Factory setting: 1
ENP version/ FF_E_N_P_VERSION Display Index: 52 Data type: visible string Access: read only	This parameter indicates the version of the standard for electronic nameplates supported by the device. Factory setting: 2.02.00
Pd-tag/FF_PD_TAG Display Index: 53 Data type: visible string Access: read only	The device tag currently configured via the display.
Serial number/ DEVICE_SERIAL_NUMBER Display Index: 54 Data type: visible string Access: read only	Displays the serial number of the device (11 alphanumeric characters).
Order code part 1/ E_N_P_ORDER_CODE_1 Display Index: 55 Data type: visible string Access: read only	Displays the extended order code (part 1).
Order code part 2/ E_N_P_ORDER_CODE_2 Display Index: 56 Data type: visible string Access: read only	Displays the extended order code (part 2).
Order code/ DEVICE_ORDER_IDENT Display Index: 57 Data type: visible string Access: read only	Displays the order number.
Firmware version/ FF_SOFTWARE_REVISION Display Index: 58 Data type: visible string Access: read only	Displays the firmware version.

Resource Block - Endress+Hauser parameters	
Parameter	Description
Hardware rev./ FF_HARDWARE_VERSION Display Index: 59 Data type: visible string Access: read only	Displays the hardware version.
FF com stack ver/ FF_COM_VERSION Display Index: 60 Data type: visible string Access: read only	Displays the FF communication version. Factory setting: 4.00.00.00
MS res directory/ MS_RES_DIRECTORY Display Index: 61 Data type: unsigned8 Access: read only	This parameter is a field of the UINT16 parameter which describes the arrangement of the extended parameters in groups. <ul style="list-style-type: none"> - Group ID (UINT16) - Number of the parameter in the group (UINT16) - Relative group revision index in the Resource Block of the first parameter in the group (UINT16)



9.12.3 Transducer Blocks







FOUNDATION Fieldbus Transducer Blocks standard parameters

Transducer Block, FOUNDATION Fieldbus standard parameters (all Transducer Blocks)	
Parameter	Description
Static Revision/ST_REV Display Index: 1 Data type: unsigned16 Access: read only	Displays the counter for static parameters of the Transducer Block. The counter is incremented by one with each change of a static parameter of the corresponding Transducer Block. The counter counts up to 65535 and then starts again at zero.
Tag Description/ TAG_DESC Entry Index: 2 Data type: octet string Access: wr for Auto, OOS	Enter a description for the related block or the measuring point e.g. TAG number (max. 32 alphanumeric characters). Factory setting: Empty field
Strategy/STRATEGY Entry Index: 3 Data type: unsigned16 Access: wr for Auto, OOS	Enter user-specific value for grouping and thus faster evaluation of the blocks. Grouping takes place by entering the same numerical value for the Strategy/STRATEGY parameter of the block in question. These data are neither checked nor processed by the Transducer Blocks. Input range: 0...65535 Factory setting: 0
Alert Key/ALERT_KEY Entry Index: 4 Data type: unsigned8 Access: wr for Auto, OOS	Enter the identification number for the measuring device or for each individual block. The control level uses this identification number to sort alarm and event messages and initiate other processing steps. Input range: 1...255 Factory setting: 0
Block Mode/ MODE_BLK Selection, display Index: 5 Data type: DS-69 Access: wr for Auto, OOS	The Block Mode/MODE_BLK parameter is a structured parameter consisting of four elements. The Transducer Blocks support the "Auto" (automatic) and OOS (out of service) modes. TARGET <ul style="list-style-type: none"> ▪ Change the block mode. ACTUAL <ul style="list-style-type: none"> ▪ Displays the current block mode. PERMITTED <ul style="list-style-type: none"> ▪ Displays the modes supported by the block. NORMAL <ul style="list-style-type: none"> ▪ Displays the block mode during standard operation.  <p>Measured values or information can be forwarded to an Analog Input Block via the Pressure, Service and DP_Flow Transducer Block. If the Pressure Transducer Block is set to the OOS block mode, the Primary Value and Secondary Value continue to be updated but the status of the downstream Analog Input Block changes to BAD.</p>
Block Error/ BLOCK_ERR Display Index: 6 Data type: bit string Access: read only	Displays the warning messages and error messages of the software and hardware of the Transducer Block in question. In addition, this parameter triggers an alarm. If two or more messages occur simultaneously, the message with the highest priority is shown on the display. For the Pressure and Totalizer Block, see possible messages, these Operating Instructions, Section 11.1 "Messages". The Display and Diagnostic Block do not display any warnings or error messages.

Transducer Block, FOUNDATION Fieldbus standard parameters (all Transducer Blocks)	
Parameter	Description
Update Event/ UPDATE_EVT Display Index: 7 Data type: DS-73 Access: read only	The Update Event/UPDATE_EVT parameter is a structured parameter consisting of five elements. UNACKNOWLEDGED <ul style="list-style-type: none"> This element is set to "Unacknowledged" as soon as a static parameter changes. UPDATE_STATE <ul style="list-style-type: none"> Indicates whether the change was reported. TIME_STAMP <ul style="list-style-type: none"> Displays the date and time when a static parameter was changed. STATIC_REVISION <ul style="list-style-type: none"> The revision counter is increased each time a static parameter is changed. RELATIVE_INDEX <ul style="list-style-type: none"> Displays the altered parameter in the form of the relative index. See also this Table, "Parameter, Index" column.
Block Alarm/ BLOCK_ALM Display, selection Index: 8 Data type: DS-72 Access: wr for Auto, OOS	The Block Alarm/BLOCK_ALM parameter is a structured parameter consisting of five elements. UNACKNOWLEDGED <ul style="list-style-type: none"> If the "Deactivated" option was selected for the alarm that occurred by means of the Acknowledge Option/ACK_OPTION parameter, this alarm can only be acknowledged by means of this element. ALARM_STATE <ul style="list-style-type: none"> Use this function to display the current block condition with information on pending configuration, hardware or system errors. TIME_STAMP <ul style="list-style-type: none"> Displays the date and time when the alarm occurred. SUB_CODE <ul style="list-style-type: none"> Displays the reason why the alarm was reported. VALUE <ul style="list-style-type: none"> Displays the value of the corresponding parameter at the time the alarm was reported.
Transducer Directory Entry/ TRANSDUCER_DIRECTORY Display Index: 9 Data type: unsigned16 Access: read only	A directory that specifies the number of transducers, and their indexes, mapped in the Pressure Transducer Block. This parameter is only displayed in the Pressure Transducer Block. Display: 0: Only one transducer is mapped in the Pressure Transducer Block.
Transducer Type/ TRANSDUCER_TYPE Display Index: 10 Data type: unsigned16 Access: read only	Displays the Transducer Block type.
Transducer Error/ XD_ERROR Display Index: 11 Data type: usigned8 Access: read only	Displays the active device state. → See also these Operating Instructions, Section 11.1 "Messages". Prerequisite: <ul style="list-style-type: none"> Pressure Transducer Block DP_FLOW Transducer Block (only Deltabar M)
Collection Directory/ COLLECTION_DIRECTORY Display Index: 12 Data type: Unsigned32 Access: read only	A directory that specifies the number of parameter groups (data collection), and their indexes and DD item IDS, mapped in the Pressure Transducer Block. This parameter is only displayed in the Pressure Transducer Block. Display: 0: This parameter is not used.



Pressure Transducer Block

Pressure Transducer Block (Profile parameters)	
Parameter	Description
Primary Value Type/ PRIMARY_VALUE_TYPE Options Index: 13 Data type: unsigned16 Access: OOS	<p>Select the measuring mode and the measured variable via this parameter.</p> <p>Options</p> <ul style="list-style-type: none"> ▪ Differential pressure with Deltabar M ▪ Gauge pressure with Cerabar M/Deltapilot M with gauge pressure sensors ▪ Absolute pressure with Cerabar M with absolute pressure sensors ▪ Level ▪ Level + lin. table ▪ Level height ▪ Lev. height + lin. table ▪ Flow (Deltabar M only) <p></p> <p>Make sure that the unit selected by means of the Scale Out/SCALE_OUT parameter, "Units Index" element suits the measured variable.</p>
Primary Value/ PRIMARY_VALUE Display Index: 14 Data type: DS-65 Access: read only	<p>The Primary Value/PRIMARY_VALUE parameter is a structured parameter consisting of two elements.</p> <p>VALUE</p> <ul style="list-style-type: none"> ▪ Displays the primary value - a pressure, level or flow value depending on the measuring mode. <p>STATUS</p> <ul style="list-style-type: none"> ▪ Displays the status of the primary value. <p></p> <p>You can transmit the value and status of the Primary Value/PRIMARY_VALUE parameter via the Channel/CHANNEL parameter (→ 2.1.1) in the Analog Input Block.</p>
Primary Value Range/ PRIMARY_VALUE_RANGE Display Index: 15 Data type: DS-68 Access: read only	<p>The Primary Value Range/PRIMARY_VALUE_RANGE parameter is a structured parameter consisting of four elements.</p> <p>EU_100</p> <ul style="list-style-type: none"> ▪ Displays the upper limit for the Primary Value/PRIMARY_VALUE. <p>EU_0</p> <ul style="list-style-type: none"> ▪ Displays the lower limit for the Primary Value/PRIMARY_VALUE. <p>UNITS_INDEX</p> <ul style="list-style-type: none"> ▪ Displays the unit for Primary Value/PRIMARY_VALUE. <p>DECIMAL</p> <ul style="list-style-type: none"> ▪ Displays the number of decimal places. <p></p> <p>The Primary Value Range/PRIMARY_VALUE_RANGE parameter corresponds to the Scale Out/SCALE_OUT parameter (→ 183).</p>

Pressure Transducer Block (Profile parameters)	
Parameter	Description
Hi Trim Sensor/ CAL_POINT_HI Display Index: 16 Data type: float Access: read only	<p>Enter the upper point of the sensor characteristic curve in the event of sensor recalibration.</p> <p>By means of this parameter, you can assign a new target pressure value to a reference pressure present at the device. The pressure value present and the target pressure value specified for this parameter correspond to the upper point in the sensor characteristic curve. Position adjustment has to be performed again for the device following sensor recalibration.</p> <p></p> <ul style="list-style-type: none"> ▪ The sensor recalibration can be reset via the Reset/RESET_INPUT_VALUE (→  207) parameter with the "2509" code. ▪ Hi trim measured/PRESSURE_1_UPPER_CAL_MEASURED (→  184) displays the pressure that was present at the device during calibration and was used for the calibration of the upper point of the sensor characteristic curve. ▪ For calibrating the lower point of the sensor characteristic curve, see the Lo trim sensor/CAL_POINT_LO parameter description. <p>Factory setting: High sensor limit (→ Sensor range/SENSOR_RANGE, EU_100 element)</p>
Lo trim sensor/ CAL_POINT_LO Display Index: 17 Data type: float Access: read only	<p>Enter the lower point of the sensor characteristic curve in the event of sensor recalibration.</p> <p>By means of this parameter, you can assign a new target pressure value to a reference pressure present at the device. The pressure value present and the target pressure value specified for this parameter correspond to the lower point in the sensor characteristic curve. Position adjustment has to be performed again for the device following sensor recalibration.</p> <p></p> <ul style="list-style-type: none"> ▪ The sensor recalibration can be reset via the Reset/RESET_INPUT_VALUE (→  178) parameter with the "2509" code. ▪ The Lo trim measured/PRESSURE_1_LOWER_CAL_MEASURED (→  184) parameter displays the pressure that was present at the device during calibration and was used for the calibration of the lower point of the sensor characteristic curve. ▪ For calibrating the upper point of the sensor characteristic curve, see Hi Trim Sensor/CAL_POINT_HI parameter description. <p>Factory setting: Low sensor limit (→ Sensor range/SENSOR_RANGE, Element EU_0)</p>
Cal min span/ CAL_MIN_SPAN Display Index: 18 Data type: float Access: read only	<p>Displays the smallest possible span.</p>
Press. eng. unit/ CAL_UNIT Entry Index: 19 Data type: unsigned16 Access: OOS	<p>Select the pressure unit.</p> <p>If a new pressure unit is selected, all pressure-specific parameters are converted and displayed with the new unit.</p> <p>Options</p> <ul style="list-style-type: none"> ▪ mbar, bar ▪ mmH₂O, mH₂O, inH₂O, ftH₂O ▪ Pa, kPa, MPa ▪ psi ▪ mmHg, inHg ▪ kgf/cm² <p>Factory setting: mbar or bar depending on the sensor nominal measuring range, or as per order specifications</p>

Pressure Transducer Block (Profile parameters)	
Parameter	Description
Sensor Type/ SENSOR_TYPE Options Index: 20 Data type: unsigned16 Access: OOS	Depending on the sensor type. Factory setting: "Capacitance", "Piezo resistive" or "MANUFACTOR SPEC". <ul style="list-style-type: none"> ▪ Flow sensor unknown ▪ Coriolis ▪ Electromagnetic ▪ mV ▪ Ohms ▪ Delta Ohms ▪ Nuclear magnetic resonance ▪ Positive displacement ▪ Refraction ▪ Taggin ▪ Ultrasonic (Doppler) ▪ Ultrasonic (time of travel) ▪ Target ▪ Variable Area ▪ Level sensor unknown ▪ Radar ▪ Capacitance ▪ Nuclear ▪ Ultrasonic ▪ Float gauge ▪ Pressure sensor unknown ▪ Resonant wire ▪ Vibrating beam ▪ Strain gauge ▪ Piezo resistive ▪ Silicon resonant ▪ Temperature sensor unknown ▪ PT100_A_385 (IEC 751) ▪ PT100_A_392 (JIS 1604) ▪ PT200_A_385 (IEC 751) ▪ PT500_A_385 (IEC 751) ▪ NI120, Edison #7 ▪ CU10, Edison #15 ▪ T/C Type B (IEC 584-1 und NIST 175) ▪ T/C Type C (NIST 175) ▪ T/C Type E (IEC 584-1 und NIST 175) ▪ T/C Type J (IEC 584-1 und NIST 175) ▪ T/C Type K (IEC 584-1 und NIST 175) ▪ T/C Type N (IEC 584-1 und NIST 175) ▪ T/C Type R (IEC 584-1 und NIST 175) ▪ T/C Type S (IEC 584-1 und NIST 175) ▪ T/C Type T (IEC 584-1 und NIST 175) ▪ T/C Type DIN L (DIN 43710) ▪ T/C Type DIN U (DIN 43710) ▪ MANUFACTOR SPEC. ▪ Non-Std Snsr
Sensor range/ SENSOR_RANGE Display Index: 21 Data type: DS-68 Access: read only	The Sensor range/SENSOR_RANGE parameter is a structured parameter consisting of four elements. EU_100 <ul style="list-style-type: none"> ▪ Displays the upper-range limit of the sensor. EU_0 <ul style="list-style-type: none"> ▪ Displays the lower-range limit of the sensor. UNITS_INDEX <ul style="list-style-type: none"> ▪ Displays the unit selected. DECIMAL <ul style="list-style-type: none"> ▪ Displays the number of decimal places.

Pressure Transducer Block (Profile parameters)	
Parameter	Description
Sensor Serial Number/ SENSOR_SN Display Index: 22 Data type: visible string Access: read only	Displays the serial number of the sensor (11 alphanumeric characters).
Sensor Calibration Method/ SENSOR_CAL_METHOD Options Index: 23 Data type: unsigned8 Access: OOS	For displaying and selecting the last sensor calibration mode used.
Sensor Calibration Location/ SENSOR_CAL_LOC Entry Index: 24 Data type: visible string Access: OOS	Enter the place the sensor was calibrated (32 alphanumeric characters).
Sensor Calibration Date/ SENSOR_CAL_DATE Entry Index: 25 Data type: date Access: OOS	Enter the date and time the sensor was calibrated.
Sensor Calibration Who/ SENSOR_CAL_WHO Entry Index: 26 Data type: visible string Access: OOS	Enter the name of the person who calibrated the sensor (32 alphanumeric characters).
Sensor Isolator Metal/ SENSOR_ISOLATOR_MTL Display Index: 27 Data type: unsigned16 Access: read only	Displays the material of the process isolating diaphragm.
Sensor Fill Fluid/ SENSOR_FILL_FLUID Display Index: 28 Data type: unsigned16 Access: read only	Displays the filling medium.

Pressure Transducer Block (Profile parameters)	
Parameter	Description
Secondary Value/ SECONDARY_VALUE Display Index: 29 Data type: DS-65 Access: read only	<p>The Secondary Value/SECONDARY_VALUE parameter is a structured parameter consisting of two elements.</p> <p>VALUE</p> <ul style="list-style-type: none"> Displays the second process value, here the sensor temperature. <p>STATUS</p> <ul style="list-style-type: none"> Displays the status of the second process value. <p></p> <p>You can transmit the value and status of the Secondary Value/SECONDARY_VALUE parameter via the Channel/CHANNEL parameter (→  211) in the Analog Input Block. The Channel/CHANNEL parameter must be set to "2" (Cerabar/Deltapilot) or "4" (Deltabar) for this purpose.</p>
Secondary Value Unit/ SECONDARY_VALUE_ UNIT Options Index: 30 Data type: unsigned16 Access: wr for Auto, OOS	<p>Select the unit for the second process value. → See also the Secondary Value/SECONDARY_VALUE parameter description.</p>

Pressure Transducer Block (Endress+Hauser parameters)	
Parameter	Description
Device dialog/ DEVICE_DIALOG Display Index: 31 Data type: unsigned8 Access: read only	<p>If configuration is unsuitable, this parameter displays a message indicating that a configuration error is present. The message can indicate which parameter was incorrectly configured.</p>
Operator code/S_W_LOCK Entry Index: 32 Data type: unsigned16 Access: wr for Auto, OOS	<p>Use this function to enter a code to lock or unlock operation.</p> <p>Options:</p> <ul style="list-style-type: none"> To lock: Enter a number ≠ the release code. To unlock: Enter the release code. <p></p> <p>The release code is "0" in the order configuration. Another release code can be defined in the Code definition/USER_S_W_UNLOCK parameter. If the user has forgotten the release code, it can be made visible again by entering the number sequence "5864".</p> <p>Factory setting: 0</p>
Lockstate/STATUS_LOCKING Display Index: 33 Data type: unsigned8 Access: read only	<p>Displays the current locking status of the device or conditions that can lock the device (hardware locking, software locking).</p>

Pressure Transducer Block (Endress+Hauser parameters)	
Parameter	Description
DIP switch/ SWITCH_STATUS_LIST Display Index: 34 Data type: unsigned8 Access: read only	Displays the DIP switches activated on the electronic insert. <ul style="list-style-type: none"> ▪ P1/P2 switch (Deltabar, inputs inversion enabled) ▪ Lin/sq. switch (Deltabar, flow has been enabled) ▪ Simulation switch (AI simulation enabled) ▪ Damping switch (damping enabled) ▪ HW lock. switch (HW locking enabled)
Scale In/SCALE_IN Entry Index: 35 Data type: DS-65 Access: OOS	The Scale In/SCALE_IN-parameter is a structured parameter consisting of four elements. <p>EU_100</p> <ul style="list-style-type: none"> ▪ "Pressure" measuring mode; "Level in pressure" measuring mode; "Level in height" measuring mode; enter the upper limit for the pressure value of the Transducer Block. ▪ "Flow" measuring mode: Enter the maximum pressure of the primary device. → See layout sheet of primary element. This value is assigned to the maximum flow value (→ See the following Scale Out/SCALE_OUT parameter, EU_100 element). ▪ Factory setting: Upper range limit of the sensor <p>EU_0</p> <ul style="list-style-type: none"> ▪ "Pressure" measuring mode; "Level in pressure" measuring mode; "Level in height" measuring mode; "Flow" measuring mode: Enter the lower limit for the pressure value of the Transducer Block. ▪ Factory setting: 0 <p>UNITS_INDEX</p> <ul style="list-style-type: none"> ▪ Select the unit for input scaling. <p>DECIMAL</p> <ul style="list-style-type: none"> ▪ Displays the number of decimal places.
Scale Out/SCALE_OUT Entry Index: 36 Data type: DS-68 Access: OOS	The Scale Out/SCALE_OUT-parameter is a structured parameter consisting of four elements. <p>EU_100</p> <ul style="list-style-type: none"> ▪ "Pressure" measuring mode; "Level in pressure" measuring mode; "Level in height" measuring mode; enter the upper limit for the output value of the Transducer Block. Factory setting: 100 ▪ "Flow" measuring mode: Enter the maximum flow of the primary device. See also layout sheet of primary element. The maximum flow is assigned to the maximum pressure which you enter via the Scale In/SCALE_IN parameter, EU_100 element. Factory setting: 1.0 <p>EU_0</p> <ul style="list-style-type: none"> ▪ "Pressure" measuring mode; "Level in pressure" measuring mode; "Level in height" measuring mode; enter the lower limit for the output value of the Transducer Block. ▪ Factory setting: 0 <p>UNITS_INDEX</p> <ul style="list-style-type: none"> ▪ Select the unit for output scaling. <p>DECIMAL</p> <ul style="list-style-type: none"> ▪ Displays the number of decimal places. <p></p> <p>Make sure that the unit selected by means of the Scale Out/SCALE_OUT parameter, "Units Index" element suits the measured variable. → See also the Primary Value Type/PRIMARY_VALUE_TYPE (→ 178) parameter descriptions.</p>

Pressure Transducer Block (Endress+Hauser parameters)	
Parameter	Description
Damping/ PRESSURE_1_DAMPING Entry Index: 37 Data type: float Access: OOS	Enter damping time (time constant τ). The damping affects the speed at which all subsequent elements, such as the local operation, measured value (Primary Value) and output value of the Analog Input Block react to a change in the pressure. For this purpose, switch the damping switch "On". Input range: 0.0 to 999.0 s Factory setting: 2.0 s or as per order specifications
Pos. zero adjust/ PRESSURE_1_ACCEPT_ZERO_INSTALL Options Index: 38 Data type: unsigned8 Access: OOS	Due to the orientation of the device, there may be a shift in the measured value, i.e. for example, when the container is empty or partially full, the Primary Value/PRIMARY_VALUE parameter does not display zero. This parameter provides the possibility of performing position adjustment where the pressure difference between zero (set point) and the measured pressure need not be known. (A reference pressure is present at the device.) Example: <ul style="list-style-type: none"> - Primary Value/PRIMARY_VALUE = 2.2 mbar - Correct the Primary Value/PRIMARY_VALUE via the Pos. zero adjust/PRESSURE_1_ACCEPT_ZERO_INSTALL parameter with the "Confirm" option. This means that you are assigning the value 0.0 to the pressure present. - Primary Value/PRIMARY_VALUE (after pos. zero adjust) = 0.0 mbar The Calib. offset/PRESSURE_1_INSTALL_OFFSET (→ 184) parameter displays the resulting pressure difference (offset) by which the Primary Value/PRIMARY_VALUE was corrected. Options: <ul style="list-style-type: none"> ▪ Abort ▪ Confirm Factory setting: Abort
Calib. offset/ PRESSURE_1_INSTALL_OFFSET Entry Index: 39 Data type: float Access: OOS	Due to the orientation of the device, there may be a shift in the measured value, i.e. for example, when the container is empty or partly filled, the PRIMARY_VALUE parameter does not display zero or the desired value. This parameter provides the possibility of performing position adjustment where the pressure difference between zero (set point) and the measured pressure is known. (A reference pressure is not present at the device.) Example: <ul style="list-style-type: none"> - Primary Value/PRIMARY_VALUE = 2.2 mbar - Via the Calib. offset/PRESSURE_1_INSTALL_OFFSET parameter, enter the value by which the Primary Value/PRIMARY_VALUE should be corrected. To correct the Primary Value/PRIMARY_VALUE to 0.0 mbar, you must enter the value 2.2 here. (The following applies: $PRIMARY_VALUE_{new} = PRIMARY_VALUE_{old} - PRESSURE_INSTALL_OFFSET$) - Primary Value/PRIMARY_VALUE (after entry for calib. offset) = 0.0 mbar Factory setting: 0.0
Lo trim measured/ PRESSURE_1_LOWER_CAL_MEASURED Display Index: 40 Data type: float Access: read only	Displays the pressure that was present at the device during calibration and was used for the calibration of the lower point of the sensor characteristic curve. → See also the Lo trim sensor/CAL_POINT_LO parameter description (→ 179).
Hi trim measured/ PRESSURE_1_UPPER_CAL_MEASURED Display Index: 41 Data type: float Access: read only	Displays the pressure that was present at the device during calibration and was used for the calibration of the upper point of the sensor characteristic curve. → See also the Hi Trim Sensor/CAL_POINT_HI parameter description (→ 179).

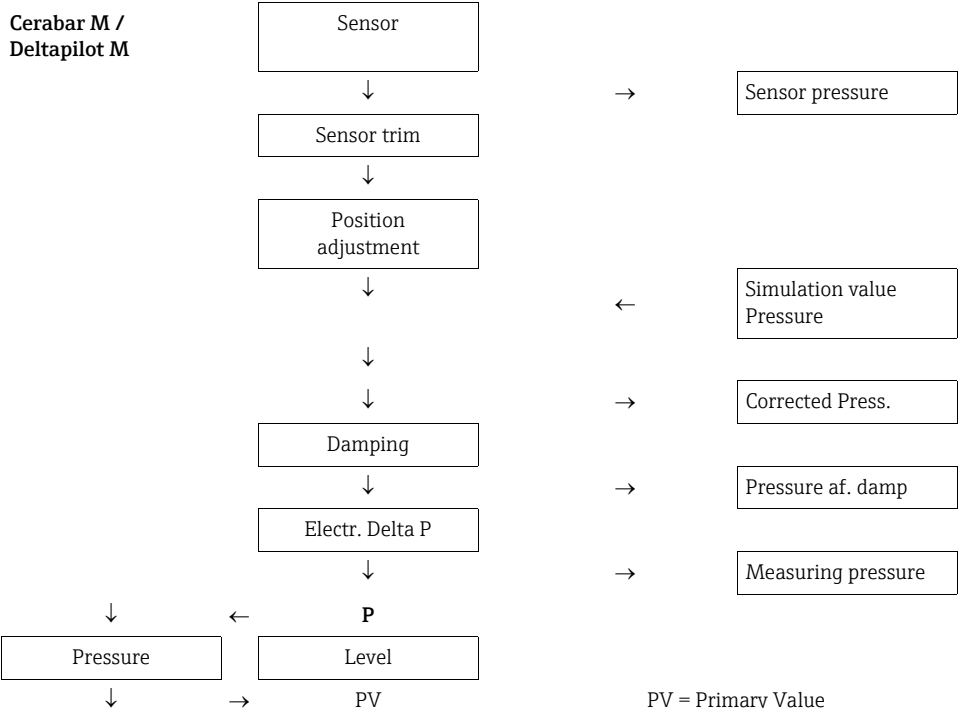
Pressure Transducer Block (Endress+Hauser parameters)	
Parameter	Description
Measuring mode/ OPERATING_MODE Display Index: 42 Data type: unsigned8 Access: OOS	Displays the measuring mode currently selected.
Level selection/ LEVEL_ADJUSTMENT Display, selection Index: 43 Data type: unsigned8 Access: OOS	Select the method for calculating the level Options: <ul style="list-style-type: none"> In pressure If this option is selected, specify two pressure/level value pairs. The level value is displayed directly in the unit that you select via the Unit before Lin./OUT_UNIT_EASY parameter. In height If this option is selected, specify two height/level value pairs. From the measured pressure, the device first calculates the height using the density. This information is then used to calculate the level in the Unit before Lin./OUT_UNIT_EASY selected using the two value pairs specified. Factory setting: In pressure
Corrected press./ PRESSURE_1_AFTER_CALIBRATION Display Index: 44 Data type: float Access: read only	Displays the measured pressure after sensor trim and position adjustment.  If this value is not equal to "0", it can be corrected to "0" by the position adjustment.
Meas. pressure/ PRESSURE_1_FINAL_VALUE Display Index: 45 Data type: float Access: read only	Displays the measured pressure after sensor trim, position adjustment and damping.
<p>Cerabar M / Deltapilot M</p>  <pre> graph TD Sensor[Sensor] --> ST[Sensor trim] ST --> PA[Position adjustment] PA --> D[Damping] D --> EDP[Electr. Delta P] EDP --> Level[Level] PA --<- SV[Simulation value Pressure] D --<- CP[Corrected Press.] EDP --<- PAD[Pressure af. damp] Level --<- MP[Measuring pressure] Level --> PV[PV] Pressure[Pressure] --> EDP </pre>	<p>PV = Primary Value</p>

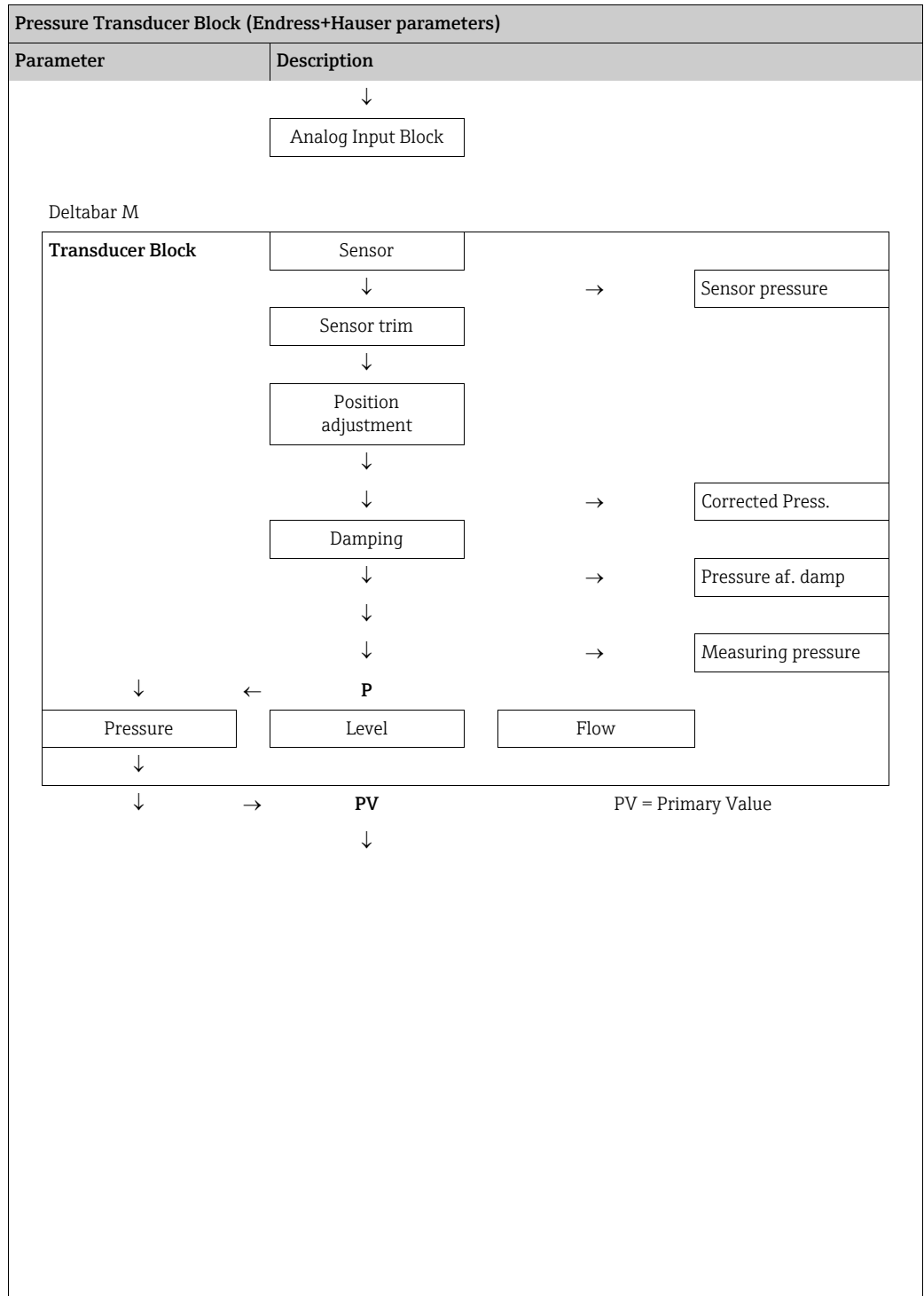

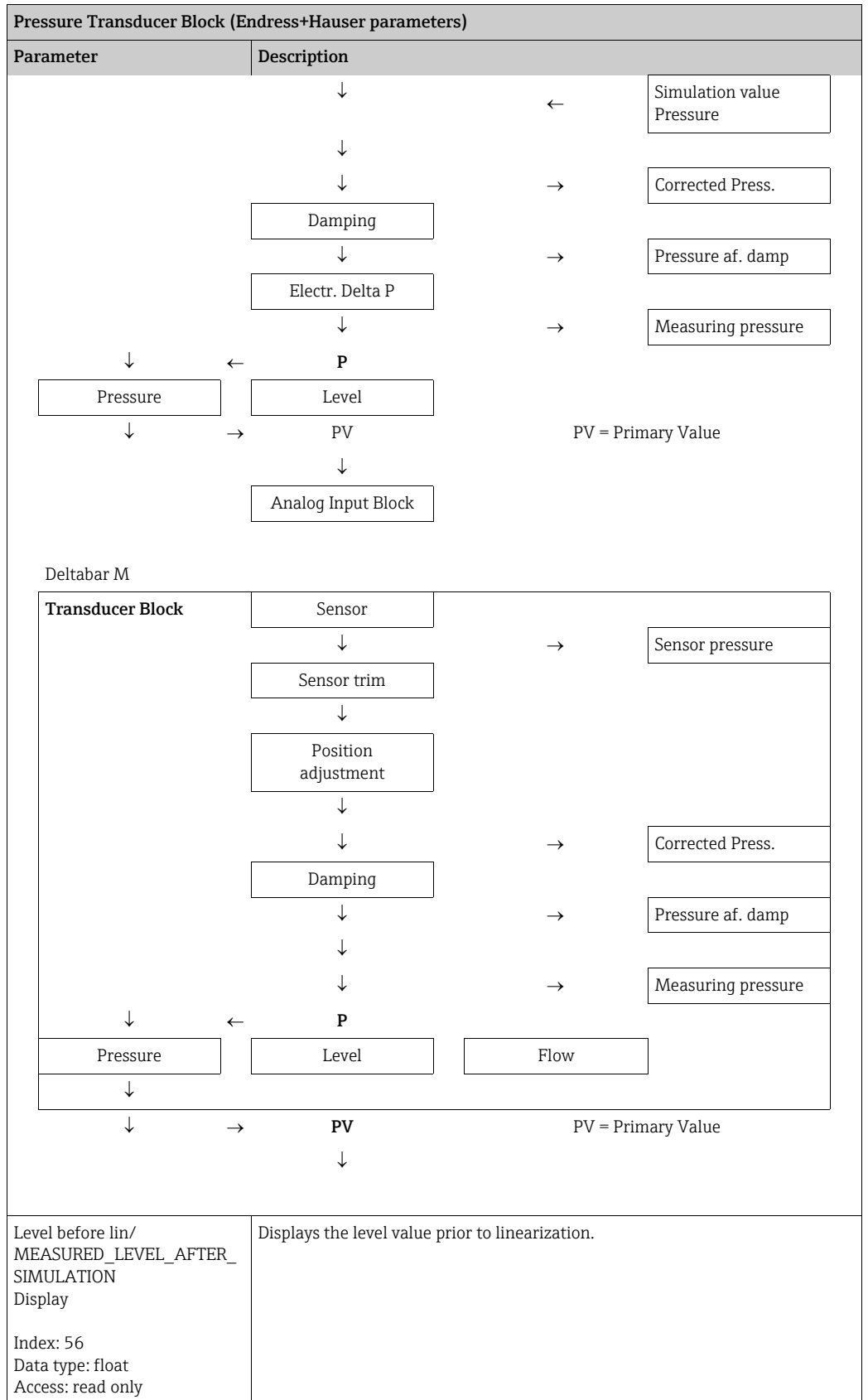

Pressure Transducer Block (Endress+Hauser parameters)	
Parameter	Description
Lin. mode/LINEARIZATION_ TABLE_ MODE Entry Index: 46 Data type: unsigned8 Access: OOS	Select the linearization mode. Options: <ul style="list-style-type: none"> ■ Linear The level is output without being converted beforehand. Level before lin/ MEASURED_ LEVEL_ AFTER_ SIMULATION is output. ■ Erase table The existing linearization table is deleted. ■ Manual entry (sets the table to the edit mode, an alarm is output): The value pairs of the table (X-value:/TB_ LINEARIZATION_ TABLE_ X_ VALUE and Y-value:/TB_ LINEARIZATION_ TABLE_ Y_ VALUE) are entered manually. ■ Semiautomatic entry (sets the table to the edit mode, an alarm is output): The container is emptied or filled in stages in this entry mode. The device automatically records the level value (X-value:/TB_ LINEARIZATION_ TABLE_ X_ VALUE). The associated volume, mass or %-value is entered manually (X-value:/TB_ LINEARIZATION_ TABLE_ X_ VALUE). ■ Activate table The table entered is activated and checked with this option. The device shows the level after linearization. Factory setting: Manual
Unit after lin./ AFTER_ LINEARIZATION_ UNIT Display, selection Index: 47 Data type: unsigned16 Access: OOS	Select the linearization unit (unit of the Y-value). Options: <ul style="list-style-type: none"> ■ % ■ cm, dm, m, mm ■ hl ■ in³, ft³, m³ ■ l ■ in, ft ■ kg, t ■ lb ■ gal ■ lgal Factory setting: %
Line numb./LINEARIZATION_ TABLE_ INDEX Entry Index: 48 Data type: unsigned8 Access: wr for Auto, OOS	Enter the number of the current point in the table. The subsequent entries in X-value:/TB_ LINEARIZATION_ TABLE_ X_ VALUE and Y-value:/TB_ LINEARIZATION_ TABLE_ Y_ VALUE refer to this point. Input range: <ul style="list-style-type: none"> ■ 1 ... 32
X-value:/ TB_ LINEARIZATION_ TABLE_ X_ VALUE Display Index: 49 Data type: float Access: read only	Display the X-value (level before linearization) for the specific point in the table and confirm. Note: If "Lin. mode" = "Manual", the level value is displayed. If "Lin. mode" = "Semiautomatic", the level value is displayed and has to be confirmed by entering the Y-value that cannot be edited. Prerequisite: <ul style="list-style-type: none"> ■ Lin. mode/LINEARIZATION_ TABLE_ MODE = Manual entry.
Y-value:/ TB_ LINEARIZATION_ TABLE_ Y_ VALUE Entry Index: 50 Data type: float Access: OOS	Enter the Y-value (value after linearization) for the specific point in the table in the "Semiautomatic" mode. Note: If "Lin. mode" = "Manual", the system displays the points after linearization. If "Lin. mode" = "Semiautomatic", entry of the points after linearization. The linearization table must be monotonic increasing or decreasing.

Pressure Transducer Block (Endress+Hauser parameters)	
Parameter	Description
Edit table/ LINEARIZATION_TABLE_EDIT Display, selection Index: 51 Data type: unsigned8 Access: OOS	Select the function for entering the table. Options: <ul style="list-style-type: none"> ▪ Next point: enter the next point. ▪ Current point: stay on the current point to correct a mistake for example. ▪ Previous point: skip back to the previous point to correct a mistake for example. ▪ Insert point: insert an additional point (see example below). ▪ Delete point: delete the current point (see example below). Example: Add a point - in this case between the 4th and 5th point for example - Select point 5 via the "Line-numb." parameter. - Select the "Insert point" option via the "Edit table" parameter. - Point 5 is displayed for the "Line-numb" parameter. Enter new values for the "X-value" and "Y-value" parameters. Example: Delete a point - in this case the 5th point for example. - Select point 5 via the "Line-numb." parameter. - Select the "Delete point" option via the "Edit table" parameter. - The 5th point is deleted. All of the subsequent points are moved up one number i.e. following deletion, the 6th point becomes Point 5. Factory setting: Current point
Tank Description/ LEVEL_TANK_DESCRIPTION Entry Index: 52 Data type: visible string Access: wr for Auto, OOS	Enter tank description. (max. 32 alphanumeric characters) Factory setting: -----
Tank content/ MEASURED_TANK_CONTENT_AFTER_SIM Display Index: 53 Data type: float Access: read only	Displays the level value after linearization.
Sensor pressure/ PRESSURE_1_AFTER_SENSOR Display Index: 54 Data type: float Access: read only	Displays the measured pressure before sensor trim, position adjustment and damping. → See also the following graphic, Meas. pressure/PRESSURE_1_FINAL_VALUE parameter description.
Pressure af. damp./ PRESSURE_1_AFTER_DAMPING Display Index: 55 Data type: float Access: read only	Displays the measured pressure after sensor trim, position adjustment and damping. This value corresponds to the Primary Value/PRIMARY_VALUE parameter in the "Pressure" measuring mode.
Cerabar M / Deltapilot M	<pre> graph TD A[Sensor] --> B[Sensor trim] B --> C[Position adjustment] C --> D[Sensor Pressure] </pre>



Pressure Transducer Block (Endress+Hauser parameters)	
Parameter	Description
Lin tab index 01/ LIN_TAB_X_Y_VALUE_1 Entry/Display Index: 57 Data type: record Access: OOS	Position 1 of the X and Y values of the linearization table. The X and Y values can be entered (edited) if the Lin. mode/LINEARIZATION_TABLE_MODE is set to "Manual". The data can only be displayed if the Lin. mode/LINEARIZATION_TABLE_MODE is not set to "Manual".
...	...
Lin tab index 32/ LIN_TAB_X_Y_VALUE_32 Entry/Display Index: 88 Data type: record Access: OOS	Position 32 of the X and Y values of the linearization table. The X and Y values can be entered (edited) if the Lin. mode/LINEARIZATION_TABLE_MODE is set to "Manual". The data can only be displayed if the Lin. mode/LINEARIZATION_TABLE_MODE is not set to "Manual".
Sensor meas. type/ SENSOR_MEASUREMENT_TYPE Display Index: 89 Data type: unsigned16 Access: read only	Displays the sensor type. <ul style="list-style-type: none"> ▪ Deltabar M = differential ▪ Cerabar M with gauge pressure sensors = gauge ▪ Cerabar M with absolute pressure sensors = absolute ▪ Deltapilot M with gauge pressure sensors = gauge
Height unit/ HEIGHT_UNIT_EASY Options Index: 90 Data type: unsigned16 Access: OOS	Select the height unit. The measured pressure is converted to the selected height unit using the Density unit/DENSITY_UNIT_EASY and Adjust density/LEVEL_ADJUST_DENSITY_EASY parameter. Prerequisite: Primary Value Type/PRIMARY_VALUE_TYPE parameter is set to "Level height" or "Lev. height+LinTab". Options: <ul style="list-style-type: none"> ▪ mm ▪ m ▪ in ▪ ft Factory setting: m

Pressure Transducer Block (Endress+Hauser parameters)	
Parameter	Description
Unit before Lin./ OUT_UNIT_EASY Options Index: 91 Data type: unsigned16 Access: OOS	Select the unit for the measured value display for the level before linearization.  The unit selected is only used to describe the measured value. This means that the measured value is not converted when a new output unit is selected. Example: <ul style="list-style-type: none"> ▪ Current measured value: 0.3 ft ▪ New output unit: m ▪ New measured value: 0.3 m Options <ul style="list-style-type: none"> ▪ % ▪ mm, cm, dm, m ▪ ft, in ▪ m³, in³ ▪ l, hl ▪ ft³ ▪ gal, lgal ▪ kg, t ▪ lb Factory setting: %
Calibration mode/ LEVEL_ADJUST_MODE_EASY Options Index: 92 Data type: unsigned8 Access: OOS	Select the calibration mode. Options: <ul style="list-style-type: none"> ▪ Wet Wet calibration takes place by filling and emptying the container. In the case of two different levels, the level, volume, mass or percentage value entered is assigned to the pressure measured at this point in time. (→ See also this table, Empty calibration/LOW_LEVEL_EASY and Full calib./HIGH_LEVEL_EASY parameter descriptions) ▪ Dry Dry calibration is a theoretical calibration. For this calibration, you specify two pressure/level value pairs via the following parameters Empty calibration/LOW_LEVEL_EASY, Empty pressure/LOW_LEVEL_PRESSURE_EASY, Full calib./HIGH_LEVEL_EASY and Full pressure/HIGH_LEVEL_PRESSURE_EASY. Factory setting: Wet - if PRIMARY_VALUE_TYPE "Level" or "Level+LinTab" Dry - if PRIMARY_VALUE_TYPE "Level height" or "Lev height+LinTab"
Density unit/ DENSITY_UNIT_EASY Display Index: 93 Data type: unsigned16 Access: read only	Displays the density unit. The measured pressure is converted to a height using the Height unit/HEIGHT_UNIT_EASY and Adjust density/LEVEL_ADJUST_DENSITY_EASY parameters. Factory setting: <ul style="list-style-type: none"> ▪ g/cm³
Adjust density/ LEVEL_ADJUST_DENSITY_EASY Index: 94 Data type: FLOAT Access: OOS	Enter the density of the medium. The measured pressure is converted to a height using the Height unit/HEIGHT_UNIT_EASY, Density unit/DENSITY_UNIT_EASY and Adjust density/LEVEL_ADJUST_DENSITY_EASY parameters. Factory setting: 1.0

Pressure Transducer Block (Endress+Hauser parameters)	
Parameter	Description
Empty height/ LEVEL_OFFSET_EASY Entry/Display Index: 95 Data type: FLOAT Access: OOS	Enter the level, volume, mass or percentage value for the lower calibration point (empty container). The values entered for the Empty calibration/LOW_LEVEL_EASY and Empty pressure/LOW_LEVEL_PRESSURE_EASY parameters form the pressure/level value pair for the lower calibration point. The unit is selected via the Unit before Lin./OUT_UNIT_EASY parameter (→ Seite 191). Prerequisite: <ul style="list-style-type: none"> ▪ Level selection/LEVEL_ADJUSTMENT = in height or Primary Value/ PRIMARY_VALUE parameter is set to "Level height" or "Lev height+LinTab" ▪ Calibration mode/LEVEL_ADJUST_MODE_EASY = Dry Factory setting: 0.0
Full height/ LEVEL_100_PERCENT_EASY Entry/Display Index: 96 Data type: FLOAT Access: OOS	Enter the height, volume, mass or percentage value for the upper calibration point (container full). The values entered for the Full calib./HIGH_LEVEL_EASY and Full pressure/HIGH_LEVEL_PRESSURE_EASY parameters form the pressure/level value pair for the upper calibration point. The unit is selected via the Unit before Lin./OUT_UNIT_EASY parameter (→ 191). Prerequisite: <ul style="list-style-type: none"> ▪ Level selection/LEVEL_ADJUSTMENT = in height or Primary Value/ PRIMARY_VALUE parameter is set to "Level height" or "Lev height+LinTab" ▪ Calibration mode/LEVEL_ADJUST_MODE_EASY = Dry Factory setting: 100.0
Process density/ LEVEL_MEASUREMENT_DENSITY_EASY Entry Index: 97 Data type: FLOAT Access: OOS	Enter a new density value for density correction. The calibration was carried out with water as the medium, for example. Now the container is to be used for another medium with another density. The calibration is corrected appropriately by entering the new density value for the Process density/LEVEL_MEASUREMENT_DENSITY_EASY parameter.  See also the Adjust density/LEVEL_ADJUST_DENSITY_EASY parameter. Factory setting: 1.0
Meas. level/ MEASURED_ACTUAL_LEVEL_EASY Display Index: 98 Data type: FLOAT Access: read only	Displays the level currently measured. The measured pressure is converted to a height using the Density unit/DENSITY_UNIT_EASY and Adjust density/LEVEL_ADJUST_DENSITY_EASY parameters.
Full calib./HIGH_LEVEL_EASY Options Index: 99 Data type: FLOAT Access: OOS	Enter the height value for the upper calibration point (container full). Select the unit via the Height unit/HEIGHT_UNIT_EASY parameter (→ 190).  <ul style="list-style-type: none"> ▪ In the case of wet calibration, the level (container full) must actually be available. The associated pressure is then automatically recorded by the device. ▪ In the case of dry calibration, the level (container full) does not have to be available. The associated pressure has to be entered in the Full pressure/HIGH_LEVEL_PRESSURE_EASY parameter for the "In pressure" level selection. The associated height must be entered in the Full height/LEVEL_100_PERCENT_EASY parameter for the "In height" level selection.

Pressure Transducer Block (Endress+Hauser parameters)	
Parameter	Description
Empty calibration/ LOW_LEVEL_EASY Options Index: 100 Data type: FLOAT Access: OOS	Enter the height value for the lower calibration point (container empty). Select the unit via the Height unit/HEIGHT_UNIT_EASY parameter (→ 190).  <ul style="list-style-type: none"> ■ In the case of wet calibration, the level (container empty) must actually be available. The associated pressure is then automatically recorded by the device. ■ In the case of dry calibration, the level (container empty) does not have to be available. The associated pressure has to be entered in the Empty pressure/LOW_LEVEL_PRESSURE_EASY parameter for the "In pressure" level selection. The associated height must be entered in the Empty height/LEVEL_OFFSET_EASY parameter for the "In height" level selection.
Full pressure/ HIGH_LEVEL_PRESSURE_EASY Entry Index: 101 Data type: FLOAT Access: OOS	Enter the pressure value for the upper calibration point (container full). → See also Full calib./HIGH_LEVEL_EASY. Prerequisite: <ul style="list-style-type: none"> ■ Calibration mode/LEVEL_ADJUST_MODE_EASY = Dry Factory setting: Upper range limit (URL) is converted to a unit of height.
Empty pressure/ LOW_LEVEL_PRESSURE_EASY Entry Index: 102 Data type: FLOAT Access: OOS	Enter the pressure value for the lower calibration point (container empty). → See also Empty calibration/LOW_LEVEL_EASY. Prerequisite: <ul style="list-style-type: none"> ■ Calibration mode/LEVEL_ADJUST_MODE_EASY = Dry Factory setting: Lower range limit (LRL) is converted to a unit of height.
Electr. delta P/ ELECTRIC_DELTA_P_CONTROL Options Index: 103 Data type: unsigned8 Access: OOS	For switching the electr. delta P application on or off with an external or constant value. Options: <ul style="list-style-type: none"> ■ Off ■ External value ■ Constant Factory setting: Off
E.delta p selec./ E_DELTA_P_INPUT_SELECTOR Options Index: 104 Data type: unsigned8 Access: OOS	Select the input of the Input Selector Block which should be used for the electr. delta P application. Options: <ul style="list-style-type: none"> ■ Input 1 ■ Input 2 ■ Input 3 ■ Input 4 Factory setting: Input 1
E. delta p value/ E_DELTA_P_VALUE Display Index: 105 Data type: float Access: read only	Displays the current input values for electr. delta P.

Pressure Transducer Block (Endress+Hauser parameters)	
Parameter	Description
E. delta p status/ E_DELTA_P_STATUS Display Index: 106 Data type: unsigned8 Access: read only	Displays the status of the current input values for electr. delta P (Good, Uncertain or Bad). Factory setting: Uncertain
E.delta p unit/ E_DELTA_P_INPUT_UNIT Selection Index: 107 Data type: unsigned8 Access: OOS	Select the unit of the electr. delta P input value. Options: <ul style="list-style-type: none"> ▪ mbar, bar ▪ mmH2O ▪ inH2O, ftH2O ▪ Pa, kPa, MPa ▪ psi ▪ mmHg ▪ kg/cm³ Factory setting: mbar
Fixed ext. value/ ELECTRIC_DELTA_P_CONST ANT Entry Index: 108 Data type: FLOAT Access: OOS	Use this function to enter the constant value. The value refers to E.delta p unit/E_DELTA_P_INPUT_UNIT. Factory setting: 0.0
Min. meas. press./ PRESSURE_1_MIN_RESETABLE Display Index: 109 Data type: FLOAT Access: read only	Displays the lowest pressure value measured (peakhold indicator). You can reset this indicator by means of the Reset peakhold/RESET_TRANSMITTER_OBSERVATION parameter.
Max. meas. press./ PRESSURE_1_MAX_RESETABLE Display Index: 110 Data type: FLOAT Access: read only	Displays the highest pressure value measured (peakhold indicator). You can reset this indicator by means of the Reset peakhold/RESET_TRANSMITTER_OBSERVATION parameter.
Reset peakhold/ RESET_TRANSMITTER_OBSERVATION Options Index: 111 Data type: unsigned8 Access: OOS	You can reset the "Min. meas. press." and "Max. meas. press." indicators with this parameter. Options: <ul style="list-style-type: none"> ▪ Abort ▪ Confirm Factory setting: Abort
Sensor temp. (Cerabar/ Deltapilot)/ MEASURED_TEMPERATURE_1 Display Index: 112 Data type: FLOAT Access: read only	Displays the temperature currently measured in the sensor. This can deviate from the process temperature.

Pressure Transducer Block (Endress+Hauser parameters)	
Parameter	Description
Temp. eng. unit/ TEMPERATURE_UNIT Options Index: 113 Data type: unsigned16 Access: OOS	Select the unit for the temperature measured values.  The setting affects the unit for the Sensor temp. (Cerabar/Deltapilot)/ MEASURED_TEMPERATURE_1 parameter. Options: <ul style="list-style-type: none"> ■ °C ■ °F ■ K Factory setting: °C
Device name str./ GENERIC_DEVICE_TYPE Display Index: 114 Data type: unsigned8 Access: read only	Displays the device type (Cerabar M, Deltabar M or Deltapilot M).
Format 1st value/ DISPLAY_MAINLINE_FORMAT Display Index: 115 Data type: unsigned8 Access: read only	Displays the number of decimal places. Options: <ul style="list-style-type: none"> ■ x.x ■ x.xx ■ x.xxx ■ x.xxxx ■ x.xxxxx

DP_FLOW Transducer Block (only Deltabar M)

DP_FLOW Transducer Block	
Parameter	Description
Device dialog/ DEVICE_DIALOG Display Index: 11 Data type: unsigned8 Access: read only	If configuration is unsuitable, this parameter displays a message indicating that a configuration error is present. The message can indicate which parameter was incorrectly configured.
Operator code/S_W_LOCK Entry Index: 12 Data type: unsigned16 Access: wr for Auto, OOS	Use this function to enter a code to lock or unlock operation. Options: <ul style="list-style-type: none"> ■ To lock: Enter a number ≠ the release code. ■ To unlock: Enter the release code.  The release code is "0" in the order configuration. Another release code can be defined in the Code definition/USER_S_W_UNLOCK parameter. If the user has forgotten the release code, it can be made visible again by entering the number sequence "5864". Factory setting: 0
Lockstate/STATUS_LOCKING Display Index: 13 Data type: unsigned8 Access: read only	Displays the current locking status of the device or conditions that can lock the device (hardware locking, software locking).



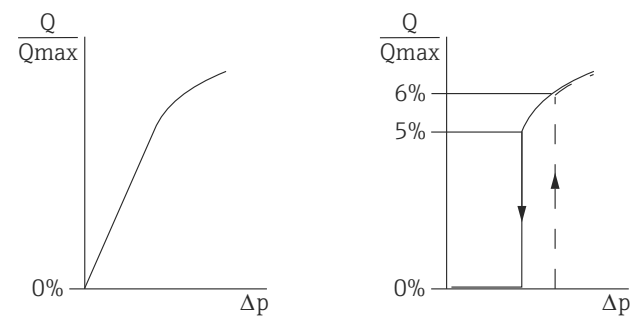

DP_FLOW Transducer Block	
Parameter	Description
DIP switch/ SWITCH_STATUS_LIST Display Index: 14 Data type: unsigned8 Access: read only	Displays the DIP switches activated on the electronic insert. <ul style="list-style-type: none"> ▪ P1/P2 switch (Deltabar, inputs inversion enabled) ▪ Lin/sq. switch (Deltabar, flow has been enabled) ▪ Simulation switch (AI simulation enabled) ▪ Damping switch (damping enabled) ▪ HW lock. switch (HW locking enabled)
Flow meas. type/FLOW_TYPE Options Index: 15 Data type: unsigned8 Access: OOS	Select the flow type. Prerequisite: <ul style="list-style-type: none"> ▪ Deltabar M differential pressure transmitter Options <ul style="list-style-type: none"> ▪ Volume process cond. (volume under operating conditions) ▪ Volume norm. cond. (norm volume under norm conditions in Europe: 1013.25 mbar and 273.15 K (0 °C)) ▪ Volume std. cond. (standard volume under standard conditions in USA: 1013.25 mbar (14.7 psi) and 288.15 K (15 °C/59 °F)) ▪ Mass p. cond. (mass under operating conditions) ▪ Flow in % Factory setting: Volume operat. cond.
Flow/ FLOW_AFTER_SUPPRESSION Display Index: 16 Data type: float Access: read only	Displays the current flow. Depending on the flow mode selected (→ Flow meas. type/FLOW_TYPE), a volume flow, mass flow, standard volume flow or corrected volume flow is displayed.



DP_FLOW Transducer Block	
Parameter	Description
Flow unit/FLOW_UNIT Entry Index: 17 Data type: unsigned16 Access: OOS	<p>Select flow unit.</p> <p>Prerequisite:</p> <ul style="list-style-type: none"> ■ Deltabar M differential pressure transmitter <p></p> <p>Make sure that the unit suits the flow mode selected. → See also → 196, Flow meas. type/FLOW_TYPE parameter description.</p> <p>When a new flow unit is selected, all flow-specific parameters are converted and displayed with the new unit within a flow type Flow meas. type/FLOW_TYPE. When the flow type is changed, conversion is not possible.</p> <p>Possible units for Flow meas. type/FLOW_TYPE = Volume operat. cond.:</p> <ul style="list-style-type: none"> ■ m³/s, m³/min, m³/h, m³/d ■ l/s, l/min, l/h ■ hl/s, hl/min, hl/d ■ ft³/s, ft³/min, ft³/h, ft³/d ■ ACFS, ACFM, ACFH, ACFD ■ ozf/s, ozf/min ■ gal/S, gal/min, gal/h, gal/d ■ lgal/s, lgal/min, lgal/h ■ bbl/s, bbl/min, bbl/h, bbl/d <p>Factory setting: m³/s</p> <p>Possible units for Flow meas. type/FLOW_TYPE = Volume norm. cond.:</p> <ul style="list-style-type: none"> ■ Nm³/s, Nm³/min, Nm³/h, Nm³/d <p>Factory setting: Nm³/s</p> <p>Possible units for Flow meas. type/FLOW_TYPE = Volume std. cond.:</p> <ul style="list-style-type: none"> ■ Sm³/s, Sm³/min, Sm³/h, Sm³/d ■ SCFS, SCFM, SCFH, SCFD <p>Factory setting: Sm³/s</p> <p>Possible units for Flow meas. type/FLOW_TYPE = Mass p. cond.:</p> <ul style="list-style-type: none"> ■ g/s, kg/s, kg/min, kg/h ■ t/s, t/min, t/h, t/d ■ oz/s, oz/min ■ lb/s, lb/min, lb/h ■ ton/s, ton/min, ton/h, ton/d <p>Factory setting: kg/s</p> <p>Possible units for Flow meas. type/FLOW_TYPE = Flow in %:</p> <ul style="list-style-type: none"> ■ % <p>Factory setting: %</p>



DP_FLOW Transducer Block	
Parameter	Description
Set. L. Fl. Cut-off/ CREEP_FLOW_SUPPRESSION_ OFF_THRES Options Index: 18 Data type: float Access: OOS	Enter switch-on point of the flow-flow cut-off. The hysteresis between the switch-on point and the switch-off point is always 1 % of the maximum flow value. Input range: Switch-off point: 0 to 50% of end flow value (Flow Max/MAX_FLOW).  Factory setting: 5 % (of the maximum flow value)
Flow Max/MAX_FLOW Entry Index: 19 Data type: float Access: OOS	Enter maximum flow of primary element. → See also layout sheet of primary device. The maximum flow is assigned to the maximum pressure which you enter via Max press. flow/ FLOW_MAX_PRESSURE. Factory setting 1.0
Pressure af. damp./ PRESSURE_1_AFTER_DAMPING Display Index: 20 Data type: float Access: read only	Displays the measured pressure after sensor trim, position adjustment and damping. This value corresponds to the Primary Value/PRIMARY_VALUE parameter in the "Pressure" measuring mode.

Deltabar M

Transducer Block	Sensor ↓ Sensor trim ↓ Position adjustment ↓ Damping ↓ ↓ ↓ P	→ Sensor Pressure → Corrected Press. → Pressure af. damp → Measuring pressure
↓ Pressure ↓	← Level ↓	↓ Flow ↓
↓ → PV	PV = Primary Value	

DP_FLOW Transducer Block	
Parameter	Description
Max press. flow/ FLOW_MAX_PRESSURE Entry Index: 21 Data type: float Access: OOS	Enter maximum pressure of primary element. → See layout sheet of primary device. This value is assigned to the maximum flow value (→ see Flow Max/MAX_FLOW). Factory setting: High sensor limit (→ see PRESS. SENS HILIM, Sensor range/SENSOR_RANGE →  180)
Press. eng. unit/ PRESSURE_1_UNIT Display Index: 22 Data type: unsigned16 Access: OOS	Displays the pressure unit selected. The pressure unit is selected by means of the Calibration Units/CAL_UNIT parameter (→  143) in the Pressure Transducer Block.
Totalizer 1/TOTALIZER_1 Display Index: 23 Data type: DS-65 Access: read only	The Totalizer 1/TOTALIZER_1 parameter is a structured parameter consisting of two elements. VALUE <ul style="list-style-type: none"> Displays the total flow value of totalizer 1. You can reset the value with the Reset Totalizer 1/TOTALIZER_1_RESET parameter. STATUS <ul style="list-style-type: none"> Displays the status.  <ul style="list-style-type: none"> You can transmit the value and status of this parameter via the Channel/CHANNEL parameter (→  211) in the Analog Input Block. The Channel/CHANNEL must be set to "6" for this purpose. You can reset the value of this parameter via the Channel/CHANNEL parameter in the Discrete Output Block. The Channel/CHANNEL must be set to "2.1" for this purpose.
Eng. unit total. 1/ TOTALIZER_1_UNIT Options Index: 24 Data type: unsigned16 Access: OOS	Select unit for totalizer 1. Depending on the setting in the Flow meas. type/FLOW_TYPE parameter (→  196), this parameter offers a list of volume, norm volume, standard volume and mass units. When a new volume or mass unit is selected, totalizer-specific parameters are converted and displayed with the new unit within a unit group. When the flow mode is change, the totalizer value is not converted. Factory setting: m ³
Totalizer 1 mode/ TOTALIZER_1_MODE Options Index: 25 Data type: unsigned8 Access: OOS	Define the behavior of the totalizer. Options: <ul style="list-style-type: none"> Balanced: Integration of all measured flows (positive and negative). Pos. flow only: only positive flows are integrated. Neg. flow only: only negative flows are integrated. Hold: The totalizer is stopped and keeps its current value.
Total. 1 failsafe/ TOTALIZER_1_FAIL_SAFE_MODE Options Index: 26 Data type: unsigned8 Access: OOS	Select the mode for totalizer 1 in the event of an error. Currently, only the "Actual" mode can be selected, i.e. totalizer 1 continues to count in the event of an error.

DP_FLOW Transducer Block	
Parameter	Description
Reset Totalizer 1/ TOTALIZER_1_RESET Options Index: 27 Data type: unsigned8 Access: OOS	You reset totalizer 1 to zero with this parameter. Options: <ul style="list-style-type: none"> ▪ Abort (do not reset) ▪ Reset Factory setting: Abort
Totalizer 1/ TOTALIZER_1_STRING_VALU E Display Index: 28 Data type: visible string Access: read only	Displays the total flow value of totalizer 1. You can reset the value with the Reset Totalizer 1/TOTALIZER_1_RESET parameter. The Totalizer 1 overflow/TOTALIZER_1_STRING_OVERFLOW parameter displays the overflow. Example: The value 123456789 m ³ is indicated as follows: <ul style="list-style-type: none"> - Totalizer 1: 3456789 m³ - Totalizer 1 overflow: 12 E7 m³
Totalizer 1 overflow/ TOTALIZER_1_STRING_OVER FLOW Display Index: 29 Data type: visible string Access: read only	Displays the overflow value of totalizer 1. → See also Totalizer 1/TOTALIZER_1_STRING_VALUE.
Totalizer 2/TOTALIZER_2 Display Index: 30 Data type: float Access: read only	The Totalizer 2/TOTALIZER_2 parameter is a structured parameter consisting of two elements. VALUE <ul style="list-style-type: none"> ▪ Displays the total flow value of totalizer 2. STATUS <ul style="list-style-type: none"> ▪ Displays the status.  You can transmit the value and status of this parameter via the Channel/CHANNEL parameter (→  211) in the Analog Input Block. The Channel/CHANNEL must be set to "7" for this purpose.
Eng. unit total. 2/ TOTALIZER_2_UNIT Options Index: 31 Data type: unsigned16 Access: OOS	Select the unit for totalizer 2. Prerequisite: <ul style="list-style-type: none"> ▪ Deltabar M differential pressure transmitter Factory setting: m ³
Totalizer 2 mode/ TOTALIZER_2_MODE Entry Index: 32 Data type: unsigned8 Access: OOS	Define the behavior of the totalizer. Options: <ul style="list-style-type: none"> ▪ Balanced: Integration of all measured flows (positive and negative). ▪ Pos. flow only: only positive flows are integrated. ▪ Neg. flow only: only negative flows are integrated. ▪ Hold: The totalizer is stopped and keeps its current value.
Total. 2 failsafe/ TOTALIZER_2_FAIL_SAFE_M ODE Options Index: 33 Data type: unsigned8 Access: OOS	Select the mode for totalizer 2 in the event of an error. Currently, only the "Actual" mode can be selected, i.e. totalizer 2 continues to count in the event of an error.

DP_FLOW Transducer Block	
Parameter	Description
Totalizer 2/ TOTALIZER_2_STRING_VALU E Display Index: 34 Data type: visible string Access: read only	Displays the total flow value of totalizer 2. The Total. 2 overflow/ TOTALIZER_2_STRING_OVERFLOW parameter displays the overflow. Example: The value 123456789 m ³ is indicated as follows: - Totalizer 2: 3456789 m ³ - Totalizer 2 overflow: 12 E7 m ³
Total. 2 overflow/ TOTALIZER_2_STRING_OVER FLOW Display Index: 35 Data type: visible string Access: read only	Displays the overflow value of totalizer 2. → See also Totalizer 2/TOTALIZER_2.
Measuring mode/ OPERATING_MODE Display Index: 36 Data type: unsigned8 Access: read only	Select the measuring mode. The operating menu is structured differently depending on the measuring mode selected.  If the measuring mode is changed, no conversion takes place. If necessary, the device has to be recalibrated after the measuring mode has been changed. Measuring mode display: <ul style="list-style-type: none"> ■ Pressure ■ Level ■ Flow Factory setting: Pressure
High-press. side/ PRESSURE_1_INPUT_INV Options Index: 37 Data type: unsigned8 Access: OOS	Determines, which pressure input corresponds to the high-pressure side.  This setting is only valid if the "SW/P2 High" DIP switch is switched off (see DIP switch/SWITCH_STATUS_LIST parameter). Otherwise P2 corresponds to the high-pressure side in any case. Options: <ul style="list-style-type: none"> ■ P1 High Pressure input P1 is the high-pressure side. ■ P2 High Pressure input P2 is the high-pressure side. Factory setting P1 High
Device name str./ GENERIC_DEVICE_TYPE Display Index: 38 Data type: unsigned8 Access: read only	Displays the device type (Cerabar M, Deltabar M or Deltapilot M).
Format 1st value/ DISPLAY_MAINLINE_FORMA T Display Index: 39 Data type: unsigned8 Access: read only	Displays the number of decimal places. Options: <ul style="list-style-type: none"> ■ x.x ■ x.xx ■ x.xxx ■ x.xxxx ■ x.xxxxx

Display Transducer Block

Display Transducer Block	
Parameter	Description
Device dialog/ DEVICE_DIALOG Display Index: 10 Data type: unsigned8 Access: read only	If configuration is unsuitable, this parameter displays a message indicating that a configuration error is present. The message can indicate which parameter was incorrectly configured.
Operator code/ S_W_LOCK Options Index: 11 Data type: unsigned16 Access: wr for Auto, OOS	Use this function to enter a code to lock or unlock operation. Options: <ul style="list-style-type: none"> ▪ To lock: Enter a number ≠ the release code. ▪ To unlock: Enter the release code.  <p>The release code is "0" in the order configuration. Another release code can be defined in the Code definition/USER_S_W_UNLOCK parameter. If the user has forgotten the release code, it can be made visible again by entering the number sequence "5864".</p> Factory setting: 0
Lockstate/ STATUS_LOCKING Display Index: 12 Data type: unsigned8 Access: read only	Displays the current locking status of the device or conditions that can lock the device (hardware locking, software locking).
Format 1st value/ AUTOMATIC_MAIN_LI NE_FORMAT Options Index: 13 Data type: unsigned8 Access: wr for Auto, OOS	Displays the number of decimal places. Options: <ul style="list-style-type: none"> ▪ x.x ▪ x.xx ▪ x.xxx ▪ x.xxxx ▪ x.xxxxx
Language/ DISPLAY_LANGUAGE Options Index: 14 Data type: unsigned8 Access: wr for Auto, OOS	Select the menu language for the onsite display. Options: <ul style="list-style-type: none"> ▪ English ▪ Deutsch ▪ Français ▪ Español ▪ Katakana ▪ Chinese Factory setting: English
Display mode/ DISPLAY_MAIN_LINE_ 1_CONTENT Options Index: 15 Data type: unsigned8 Access: wr for Auto, OOS	Specify the contents for the first line of the onsite display in the measuring mode. Options: <ul style="list-style-type: none"> ▪ Primary value (PV) ▪ External value ▪ All alternating Factory setting: Primary value (PV)

Display Transducer Block	
Parameter	Description
Add. disp. value/ DISPLAY_MAINLINE_2 _CONTENT Options Index: 16 Data type: unsigned8 Access: wr for Auto, OOS	Specify the contents for the second line of the onsite display in the measuring mode. Options: <ul style="list-style-type: none"> ■ No value ■ Pressure ■ Main value (%) ■ Totalizer 1 ■ Totalizer 2 The options depend on the measuring mode chosen. Factory setting: No value
FF input source/ DISPLAY_INPUT_SELE CTOR Options Index: 17 Data type: unsigned8 Access: wr for Auto, OOS	Select the input of the Input Selector Block which should be used as the external value for the display. Options: <ul style="list-style-type: none"> ■ Input 1 ■ Input 2 ■ Input 3 ■ Input 4 Factory setting: Input 1
FF input unit/ DISPLAY_INPUT_UNIT Options Index: 18 Data type: unsigned16 Access: wr for Auto, OOS	Select the unit for the external value that should be shown on the display. Factory setting: mbar
FF input form./ DISPLAY_INPUT_FOR MAT Options Index: 19 Data type: unsigned8 Access: wr for Auto, OOS	Select the format for the external value that should be shown on the display. Options: <ul style="list-style-type: none"> ■ x.x ■ x.xx ■ x.xxx ■ x.xxxx ■ x.xxxxx Factory setting: x.x
Device name str./ GENERIC_DEVICE_TYP E Display Index: 20 Data type: unsigned8 Access: read only	Displays the device type (Cerabar M, Deltabar M or Deltapilot M).

Display Transducer Block	
Parameter	Description
Measuring mode/ OPERATING_MODE Display Index: 21 Data type: unsigned8 Access: read only	Select the measuring mode. The operating menu is structured differently depending on the measuring mode selected.  If the measuring mode is changed, no conversion takes place. If necessary, the device has to be recalibrated after the measuring mode has been changed. Options: <ul style="list-style-type: none"> ▪ Pressure ▪ Level ▪ Flow Factory setting: Pressure

Diagnostic Transducer Block

Diagnostic Transducer Block	
Parameter	Description
Device dialog/DEVICE DIALOG Display Index: 10 Data type: unsigned8 Access: read only	If configuration is unsuitable, this parameter displays a message indicating that a configuration error is present. The message can indicate which parameter was incorrectly configured.
Operator code/S_W_LOCK Options Index: 11 Data type: unsigned16 Access: wr for Auto, OOS	Use this function to enter a code to lock or unlock operation. Options: <ul style="list-style-type: none"> ▪ To lock: Enter a number ≠ the release code. ▪ To unlock: Enter the release code.  The release code is "0" in the order configuration. Another release code can be defined in the Code definition/USER_S_W_UNLOCK parameter. If the user has forgotten the release code, it can be made visible again by entering the number sequence "5864". Factory setting: 0
Lockstate/STATUS_LOCKING Display Index: 12 Data type: unsigned8 Access: read only	Displays the current locking status of the device or conditions that can lock the device (hardware locking, software locking).
DIP switch/ SWITCH_STATUS_LIST Display Index: 13 Data type: unsigned8 Access: read only	Displays the DIP switches activated on the electronic insert. <ul style="list-style-type: none"> ▪ P1/P2 switch (Deltabar, inputs inversion enabled) ▪ Lin/sq. switch (Deltabar, flow has been enabled) ▪ Simulation switch (AI simulation enabled) ▪ Damping switch (damping enabled) ▪ HW lock. switch (HW locking enabled)

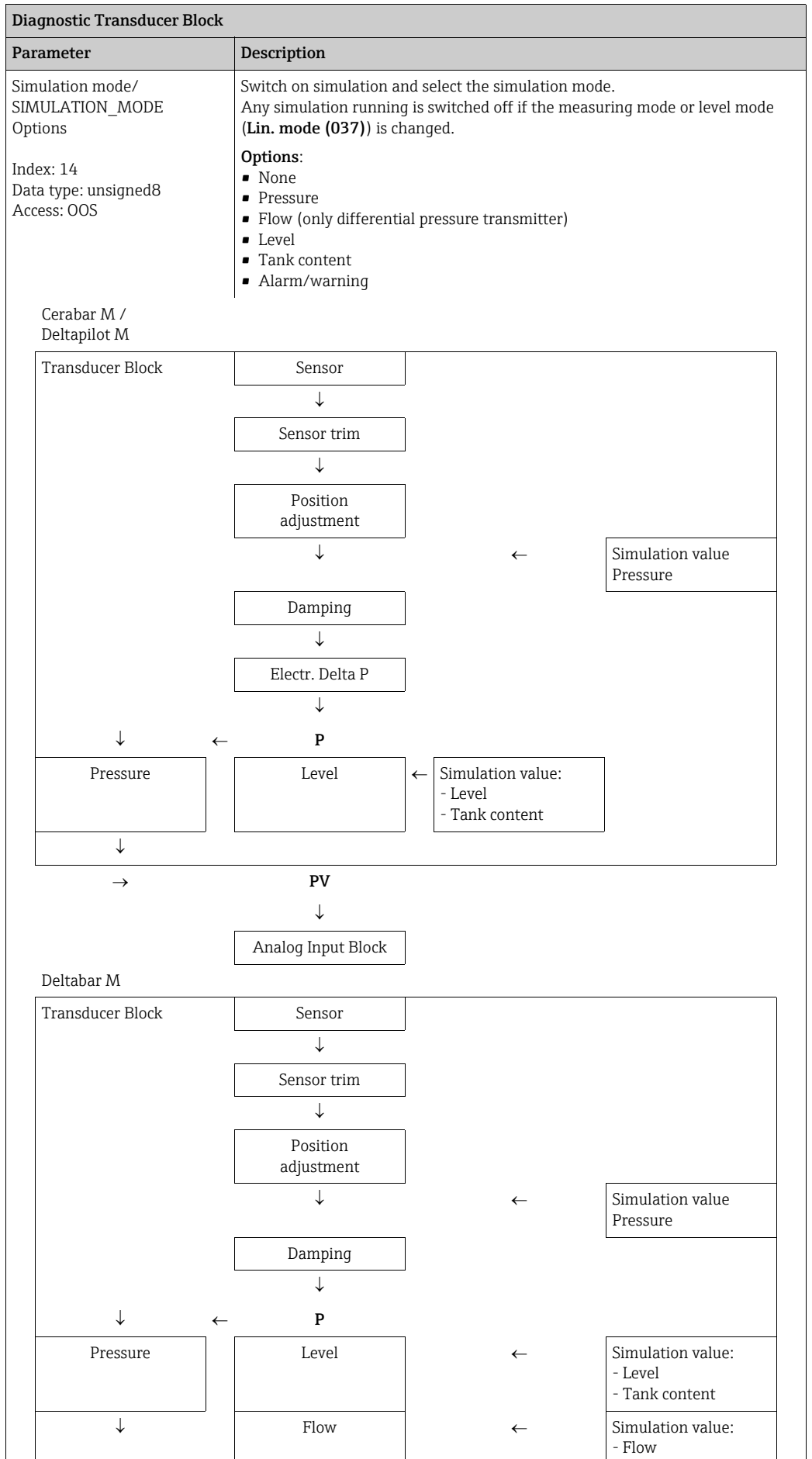



Diagnostic Transducer Block	
Parameter	Description
Simulation unit/ SIMULATION_UNIT Display Index: 15 Data type: Access: read only	Displays the unit of the simulation value (depends on the measuring mode selected).
Simulated Value/ SIMULATED_VALUE Entry Index: 16 Data type: float Access: OOS	Enter the simulation value. Prerequisite: <ul style="list-style-type: none"> Simulation/SIMULATION_MODE = Pressure, flow (Deltabar), level or tank content.
Sim. error no./ ALARM_SIMULATION_VALU E Entry Index: 17 Data type: unsigned16 Access: OOS	Enter the message number for simulation. → See also these Operating Instructions, Section 11.1 "Messages", "Code" table column. Prerequisite: <ul style="list-style-type: none"> Simulate/SIMULATE = Alarm/warning Value when switched on: 485 "Simulation value" (simulation active)
Status/DEVICE_STATUS Display Index: 18 Data type: unsigned8 Access: read only	Provides information on the current status of the device.
Diagnostic code/ ACTUAL_HIGHEST_ALARM Display Index: 19 Data type: unsigned16 Access: read only	Displays the highest active warning/error message.
Instructions/ ACTUAL_MAINTENANCE_IN STRUCT Display Index: 20 Data type: unsigned16 Access: read only	Instructions for resolving the highest active warning/error message.
Last diag. code/ LAST_ALARM_INFO_IO Display Index: 21 Data type: unsigned16 Access: read only	Last rectified error message. Equivalent to the first entry in the Last diag. code table (logbook).



Diagnostic Transducer Block	
Parameter	Description
Reset logbook/ RESET_ALARM_HISTORY Index: 22 Data type: unsigned8 Access: wr for Auto, OOS	Parameter for deleting the logbook entries. Options: <ul style="list-style-type: none"> ▪ Abort ▪ Reset Factory setting: Abort
Actual errors/ DIAG_ALARM_TABLE Display Index: 23 Data type: OctetString8 Access: read only	Bit field summary of active alarms/warnings.
Operating hours/ OPERATING_HOURS_VALUE Display Index: 24 Data type: unsigned32 Access: read only	Displays the hours of operation.
Diagnostic code/ ACTUAL_HIGHEST_ALARM Display Index: 25 Data type: record Access: read only	Table displaying the 10 current active alarms/warnings.
Instructions/ ACTUAL_MAINTENANCE_IN STRUCT_INFO Display Index: 26 Data type: record Access: read only	Table displaying the instructions for the current active alarms/warnings.
Last diag. code/ LAST_ALARM_INFOS Display Index: 27 Data type: record Access: wr for Auto, OOS	Table displaying the last 10 current rectified alarms/warnings.
Reset/RESET_INPUT_VALUE Entry Index: 28 Data type: unsigned16 Access: wr for Auto, OOS	Reset parameters completely or partially to the factory values or order configuration, →  55, "Resetting to factory settings (reset)". Factory setting: 0
Config. Recorder/ CONFIGURATION_COUNTER Display Index: 29 Data type: unsigned16 Access: read only	Displays the configuration counter. This counter is increased by 1 every time a configuration parameter or group is changed. The counter counts up to 65535 and then starts again at 0.

Diagnostic Transducer Block	
Parameter	Description
Alarm behav. P/ UNDER_OVER_PRESSURE_BE HAVIOR Options Index: 30 Data type: unsigned8 Access: OOS	This parameter specifies how the unit should react if the sensor limit is exceeded or undershot. Options: <ul style="list-style-type: none"> ▪ Warning ▪ Alarm Factory setting Warning

9.12.4 Analog Input Block (function block)

Analog Input Block	
Parameter	Description
Static Revision/ST_REV Display Index: 1 Data type: unsigned16 Access: read only	Displays the counter for static parameters of the Analog Input Block. The counter is incremented by one with each change of a static parameter of the Analog Input Block. The counter counts up to 65535 and then starts again at zero.
Tag Description/ TAG_DESC Entry Index: 2 Data type: octet string Access: wr for Auto, OOS	Enter a description for the related block or the measuring point e.g. TAG number (max. 32 alphanumeric characters).
Strategy/STRATEGY Entry Index: 3 Data type: unsigned16 Access: auto, man, OOS	Enter user-specific value for grouping and thus faster evaluation of the blocks. Grouping takes place by entering the same numerical value for the Strategy/STRATEGY parameter of the block in question. Input range: 0...65535 Factory setting: 0
Alert Key/ALERT_KEY Entry Index: 4 Data type: unsigned8 Access: auto, man, OOS	Enter the identification number for the measuring device or for each individual block. The control level uses this identification number to sort alarm and event messages and initiate other processing steps. Input range: 1...255 Factory setting: 0
Block Mode/ MODE_BLK Selection, display Index: 5 Data type: DS-69 Access: auto, man, OOS	The Block Mode/MODE_BLK parameter is a structured parameter consisting of four elements. The Analog Input Block supports the "Auto" (automatic), "Man" (value and status of the OUT parameter can be specified directly by the operator) and OOS (out of service) modes. TARGET <ul style="list-style-type: none"> ▪ Change the block mode. ACTUAL <ul style="list-style-type: none"> ▪ Displays the current block mode. PERMITTED <ul style="list-style-type: none"> ▪ Displays the modes supported by the block. NORMAL <ul style="list-style-type: none"> ▪ Displays the block mode during standard operation.

Analog Input Block	
Parameter	Description
Block Error/ BLOCK_ERR Display Index: 6 Data type: bit string Access: read only	<p>Displays the active block error.</p> <p>Possibilities:</p> <ul style="list-style-type: none"> ▪ Out of service (OOS): <ul style="list-style-type: none"> - The Analog Input Block is in the OOS block mode. - The Resource Block is in the OOS block mode. ▪ Simulation active: DIP switch 2 "Simulation" on the electronic insert is set to "on", i.e. simulation is possible. <ul style="list-style-type: none"> - The simulation mode for the Analog Input Block is active. → 210, Simulate/SIMULATE parameter description. ▪ Input failure: The input value transmitted by the Pressure or DP_Flow Transducer Block is not valid (BAD status). This could be due to the following: <ul style="list-style-type: none"> - The Pressure or DP_Flow Transducer Block is in the OOS block mode. - A device error is present. In the Diagnosis Transducer Block, the Diagnostic code parameter displays an error code. → See also these Operating Instructions, Section 11.1 "Messages". <p></p> <p>The "Input failure" block error is relayed to downstream function blocks or high-order process control systems by means of the BAD status of the output value of the OUT Analog Input Block.</p> <ul style="list-style-type: none"> ▪ Block configuration error: There is a configuration error in the Analog Input Block. This could be due to the following: <ul style="list-style-type: none"> - By means of the Transducer Scale/XD_SCALE parameter, a unit was selected that does not suit the input value configured in the Channel/CHANNEL parameter. - No valid input value was selected by means of the Channel/CHANNEL parameter. → 211, Channel/CHANNEL parameter description. - An unsuitable linearization mode was selected via the Linearization Type/L_TYPE parameter. → 212, Linearization Type/L_TYPE parameter description. - The "Direct" linearization mode was selected by means of the Linearization Type/L_TYPE parameter. The scaling for the Transducer Scale/XD_SCALE and Output Scale/OUT_SCALE parameters do not match. - If you assign the same process variable, such as "Primary value", to two Analog Input Blocks, the same scaling values and units have to be set for both blocks.
Process Value/PV Display Index: 7 Data type: DS-65 Access: read only	<p>The PV parameter is a structured parameter consisting of two elements.</p> <p>VALUE</p> <ul style="list-style-type: none"> ▪ Displays the process variable used for block execution <p>STATUS</p> <ul style="list-style-type: none"> ▪ Displays the status of the process variable. <p></p> <p>The unit used by the Output Scale/OUT_SCALE parameter is accepted.</p>
Output/OUT Display, entry Index: 8 Data type: DS-65 Access: auto, man, OOS	<p>The Output/OUT parameter is a structured parameter consisting of two elements.</p> <p>VALUE</p> <ul style="list-style-type: none"> ▪ Displays the output value of the Analog Input Block. <p>STATUS</p> <ul style="list-style-type: none"> ▪ Displays the status of the Output/OUT value. <p></p> <ul style="list-style-type: none"> ▪ The output value Output/OUT is also transmitted if it is outside the scaling range of Output Scale/OUT_SCALE. ▪ The unit used by the Output Scale/OUT_SCALE parameter is accepted. ▪ If the "MAN" (manual) block mode was selected by means of the Block Mode/MODE_BLK parameter, the output value Output/OUT and its status can be specified manually here.

Analog Input Block	
Parameter	Description
Simulate/SIMULATE Entry, display Index: 9 Data type: DS-82 Access: auto, man, OOS	<p>The Simulate/SIMULATE parameter is a structured parameter consisting of five elements. As the value and status specified here run through the complete algorithm, the behavior of the Analog Input Block can be checked.</p> <p>SIMULATE_STATUS</p> <ul style="list-style-type: none"> Enter the status for simulation. <p>SIMULATE_STATUS</p> <ul style="list-style-type: none"> Enter the simulation value. <p>TRANSDUCER_STATUS</p> <ul style="list-style-type: none"> Displays the current status of the Transducer Block which is linked to the Analog Input Block via the Channel/CHANNEL parameter. <p>TRANSDUCER_VALUE</p> <ul style="list-style-type: none"> Displays the current process value of the Transducer Block, which is linked to the Analog Input Block via the Channel/CHANNEL parameter. <p>ENABLE_DISABLE</p> <ul style="list-style-type: none"> Switch the simulation mode on and off. <p></p> <p>The "Simulation" DIP switch on the electronic insert must be set to "On".</p> <p>Factory setting: Simulation disabled (simulation mode not active)</p>
Transducer Scale/ XD_SCALE Entry, selection Index: 10 Data type: DS-68 Access: man, OOS	<p>The Transducer Scale/XD_SCALE parameter is a structured parameter consisting of four elements.</p> <p>EU_100:</p> <ul style="list-style-type: none"> Enter the upper limit for the input value of the Analog Input Block. Factory setting: 100 <p>EU_0:</p> <ul style="list-style-type: none"> Enter the lower limit for the input value of the Analog Input Block. Factory setting: 0 <p>UNITS_INDEX:</p> <ul style="list-style-type: none"> Select the unit. Factory setting: % <p>DECIMAL:</p> <ul style="list-style-type: none"> Displays the number of places after the decimal point for the input value. Factory setting: 2 <p></p> <ul style="list-style-type: none"> The Transducer Scale/XD_SCALE parameter corresponds to the Primary Value Range/PRIMARY_VALUE_RANGE parameter (→ 178) in the Transducer Block. If the "Direct" option was selected via the Linearization Type/L_TYPE parameter, the settings for the Transducer Scale/XD_SCALE and Output Scale/OUT_SCALE parameters must be identical. If this is not the case, the block goes to the OOS mode and the "Block config error" message is displayed in the Block Error/BLOCK_ERR parameter.

Analog Input Block	
Parameter	Description
Output Scale/ OUT_SCALE Entry, display Index: 11 Data type: DS-68 Access: auto, man, OOS	The Output Scale/OUT_SCALE parameter is a structured parameter consisting of four elements. EU_100: <ul style="list-style-type: none"> Enter the upper limit for the output value of the AI Block OUT (→ 209). Factory setting: 100 EU_0: <ul style="list-style-type: none"> Enter the lower limit for the output value of the AI Block OUT. Factory setting: 0 UNITS_INDEX: <ul style="list-style-type: none"> Select the unit. Factory setting: % DECIMAL: <ul style="list-style-type: none"> Displays the number of places after the decimal point for the OUT output value. Factory setting: 2  <ul style="list-style-type: none"> The OUT output value is also transmitted if it is outside the scaling range. The status changes to BAD. If the "Direct" option was selected via the Linearization Type/L_TYPE parameter, the settings for the Transducer Scale/XD_SCALE and Output Scale/OUT_SCALE parameters must be identical. If this is not the case, the block goes to the OOS mode and the "Block config error" message is displayed in the Block Error/BLOCK_ERR parameter.
Grant Deny/ GRANT_DENY Options Index: 12 Data type: DS-70 Access: auto, man, OOS	Grant or restrict access authorization for a fieldbus host system to the device. This parameter is not evaluated by Deltabar M, Cerabar M and Deltapilot M.
I/O Options/ IO_OPTS Options Index: 13 Data type: bit string Access: OOS	Activate options for processing the input and output values of the function block. Factory setting: No option activated
Status Options/ STATUS_OPTS Options Index: 14 Data type: bit string Access: OOS	Specify status processing and processing of the Output/OUT output parameter. Factory setting: No options active
Channel/CHANNEL Options Index: 15 Data type: Access: OOS	Assign the output variables (process variables) of the "Pressure" or "Totalizer" Transducer Blocks to an Analog Input Block as the input value. Possibilities <ul style="list-style-type: none"> 1: Primary value from the Pressure Transducer Block - a pressure, level or flow value depending on the measuring mode selected 2: Secondary value from the Pressure Transducer Block, here the sensor temperature 6: Totalizer 1 from the DP_Flow Transducer Block Factory setting: <ul style="list-style-type: none"> Analog Input Block 1: Channel/CHANNEL = 1: Primary value (pressure measured value) Analog Input Block 2: Channel/CHANNEL = 2: Secondary value (sensor temperature) Analog Input Block 3: Channel/CHANNEL = 6: Totalizer 1

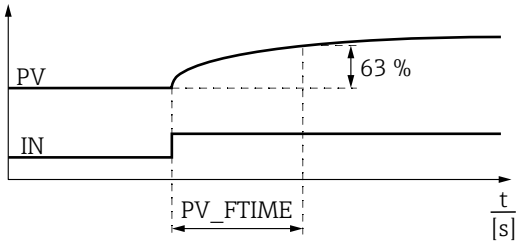
Analog Input Block	
Parameter	Description
Linearization Type/ L_TYPE Options Index: 16 Data type: unsigned8 Access: OOS	Select the linearization mode for the input value. Options: <ul style="list-style-type: none"> Direct: In this setting, the input value bypasses the linearization function and is looped unchanged with the same unit through the Analog Input function block. With this option, the scaling and unit for the Transducer Scale/XD_SCALE and Output Scale/OUT_SCALE parameters must be identical. If this is not the case, the block goes to the OOS mode and the "Block config error" message is displayed in the Block Error/BLOCK_ERR parameter. Indirect: The input value is rescaled linearly via the Transducer Scale/XD_SCALE input scaling to the desired Output Scale/OUT_SCALE output range. Indirect square root: The input value is rescaled via the Transducer Scale/XD_SCALE parameter and recalculated using a root function. It is then rescaled again to the desired output range via the Output Scale/OUT_SCALE parameter. Factory setting: Direct
Low Cutoff/LOW_CUT Entry Index: 17 Data type: float Access: auto, man, OOS	Enter the limit value for the low flow cut off. If the converted measured value is below this limit value, the Process Value/PV parameter displays "0".  This parameter is only active if the "Low cutoff" option was activated via the I/O Options/ IO_OPTS parameter. Input range: Range and unit of Output Scale/OUT_SCALE (→ 211). Factory setting: 0
Process value filter time/PV_FTIME Entry Index: 18 Data type: float Access: auto, man, OOS	Enter the filter time constant for the 1st order digital filter. This time is required in order for 63% of a change in the controlled variable IN to have an effect on the value of Process Value/PV.  <p style="text-align: right; font-size: small;">A0030421</p> Factory setting: 0 s
Field Value/ FIELD_VALUE Display Index: 19 Data type: Access: read only	The Field Value/FIELD_VALUE parameter is a structured parameter consisting of two elements. VALUE <ul style="list-style-type: none"> Displays the process variables after input scaling of the Analog Input Block. The value relates to a percentage of the Transducer Scale/XD_SCALE input range and is replaced by the simulation value when simulation is active. STATUS <ul style="list-style-type: none"> Displays the current status.

Analog Input Block	
Parameter	Description
<p>Update Event/ UPDATE_EVT Display</p> <p>Index: 20 Data type: DS-73 Access: read only</p>	<p>The Update Event/UPDATE_EVT parameter is a structured parameter consisting of five elements.</p> <p>ACKNOWLEDGED</p> <ul style="list-style-type: none"> This element is set to "Unacknowledged" as soon as a static parameter changes. <p>REPORTED</p> <ul style="list-style-type: none"> Displays the date and time when the message was generated. <p>TIME_STAMP</p> <ul style="list-style-type: none"> Displays the date and time when a static parameter was changed. <p>STATIC_REVISION</p> <ul style="list-style-type: none"> This revision counter is increased with the alarm. <p>RELATIVE_INDEX</p> <ul style="list-style-type: none"> Displays the altered parameter in the form of the relative index. See also this Table, "Parameter, Index" column.
<p>Block Alarm/ BLOCK_ALM Display, selection</p> <p>Index: 21 Data type: DS-72 Access: auto, man, OOS</p>	<p>The Block Alarm/BLOCK_ALM parameter is a structured parameter consisting of five elements.</p> <p>UNACKNOWLEDGED</p> <ul style="list-style-type: none"> If the "Deactivated" option was selected for the alarm that occurred by means of the Acknowledge Option/ACK_OPTION parameter, this alarm can only be acknowledged by means of this element. <p>ALARM_STATE</p> <ul style="list-style-type: none"> Use this function to display the current block condition with information on pending configuration, hardware or system errors. The following block alarm messages are possible with the Analog Input Block: <ul style="list-style-type: none"> Simulate active Input failure Block config error Out of service <p>TIME_STAMP</p> <ul style="list-style-type: none"> Displays the time when the alarm occurred. <p>SUB_CODE</p> <ul style="list-style-type: none"> Displays the reason why the alarm was reported. <p>VALUE</p> <ul style="list-style-type: none"> Displays the value of the corresponding parameter at the time the alarm was reported.
<p>Alarm Summary/ ALARM_SUM Display, selection</p> <p>Index: 22 Data type: DS-74 Access: auto; man, OOS</p>	<p>The Alarm Summary/ALARM_SUM parameter is a structured parameter consisting of four elements.</p> <p>CURRENT</p> <ul style="list-style-type: none"> Displays the current status of the process alarms in the Analog Input Block. The following alarms are possible: HiHiAlm, HiAlm, LoLoAlm, LoAlm and BlockAlm. <p>UNACKNOWLEDGED</p> <ul style="list-style-type: none"> Displays the process alarms not confirmed. <p>UNREPORTED</p> <ul style="list-style-type: none"> Displays the process alarms not reported. <p>DISABLED</p> <ul style="list-style-type: none"> Possibility of deactivating process alarms.

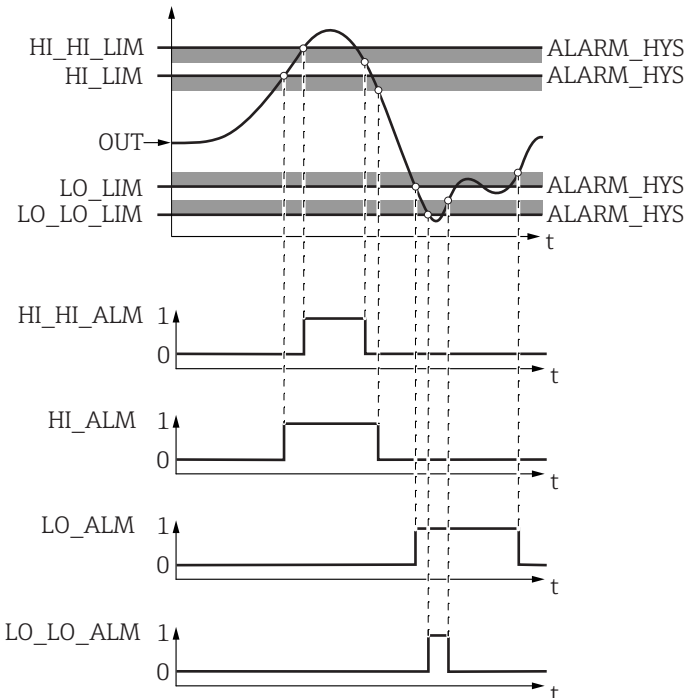
Analog Input Block	
Parameter	Description
Acknowledge Option/ ACK_OPTION Options Index: 23 Data type: bit string Access: auto, man, OOS	<p>Use this parameter to specify the process alarm to be acknowledged automatically as soon as it is detected by the fieldbus host system. If the option is activated for a process alarm, this process alarm is acknowledged automatically by the fieldbus host system.</p> <p>Options:</p> <ul style="list-style-type: none"> ▪ HiHiAlm: upper critical limit value alarm ▪ HiAlm: upper limit value alarm ▪ LoLoAlm: lower critical limit value alarm ▪ LoAlm: lower limit value alarm ▪ BlockAlm: block alarm <p></p> <p>The message has to be acknowledged via the Block Alarm/BLOCK_ALM parameter, UNACKNOWLEDGE element for process alarms for which automatic confirmation is not active.</p> <p>Factory setting: The option is not active for any process alarm, i.e. every process alarm message must be acknowledged manually.</p>
Alarm Hysteresis/ ALARM_HYS Entry Index: 24 Data type: float Access: auto, man, OOS	<p>Enter hysteresis value for the upper and lower alarm value or critical alarm value.</p> <p>The hysteresis affects the following alarm or critical alarm limit values:</p> <ul style="list-style-type: none"> ▪ High High Alarm/HI_HI_ALM: upper critical alarm limit value ▪ High Alarm/HI_ALM: upper alarm limit value ▪ Low Alarm/LO_ALM: lower alarm limit value ▪ Low Low Alarm/LO_LO_ALM: lower critical alarm limit value  <p style="text-align: right; font-size: small;">A0030423</p> <p><i>Fig. 52: Illustration of the output value Output/OUT with limit values and hysteresis as well as the alarms High High Alarm/Hi_Hi_Alm, High Alarm/Hi_Alm, Low Alarm/Lo_Alm and Low Low Alarm/Lo_Lo_Alm</i></p> <p>Input range: 0.0 to 50.0 % with regard to the range of the Output Scale/OUT_SCALE group (→ 211).</p> <p>Factory setting: 0.5 %</p>



Analog Input Block	
Parameter	Description
High High Priority/ HI_HI_PRI Entry Index: 25 Data type: unsigned8 Access: auto, man, OOS	Specify how the system should react if the High High Limit/HI_HI_LIM limit value (→ 215) is overshot. Input range: ■ 0...15 ■ 0: The alarm is suppressed. ■ 1: The alarm is detected by the system. No notification is issued. ■ 2: Reserved for block alarms. ■ 3-7: Informative alarm with increasing priority, 3: Low priority, 7: High priority ■ 8-15: Critical alarm with increasing priority, 8: Low priority, 15: High priority Factory setting: 0
High High Limit/ HI_HI_LIM Entry Index: 26 Data type: float Access: auto, man, OOS	Enter upper critical limit value. Input range: Range and units of Output Scale/OUT_SCALE (→ 211) Factory setting: +INF
High Priority/HI_PRI Entry Index: 27 Data type: unsigned8 Access: auto, man, OOS	Specify how the system should react if the High Limit/HI_LIM limit value (→ 215) is overshot. Input range: ■ 0...15 ■ 0: The alarm is suppressed. ■ 1: The alarm is detected by the system. No notification is issued. ■ 2: Reserved for block alarms. ■ 3-7: Informative alarm with increasing priority, 3: Low priority, 7: High priority ■ 8-15: Critical alarm with increasing priority, 8: Low priority, 15: High priority Factory setting: 0
High Limit/HI_LIM Entry Index: 28 Data type: float Access: auto, man, OOS	Enter upper limit value. Input range: Range and units of Output Scale/OUT_SCALE (→ 211) Factory setting: +INF
Low Priority/LO_PRI Entry Index: 29 Data type: unsigned8 Access: auto, man, OOS	Specify how the system should react if the Low Limit/LO_LIM limit value (→ 215) is undershot. Input range: ■ 0...15 ■ 0: The alarm is suppressed. ■ 1: The alarm is detected by the system. No notification is issued. ■ 2: Reserved for block alarms. ■ 3-7: Informative alarm with increasing priority, 3: Low priority, 7: High priority ■ 8-15: Critical alarm with increasing priority, 8: Low priority, 15: High priority Factory setting: 0
Low Limit/LO_LIM Entry Index: 30 Data type: float Access: auto, man, OOS	Enter lower limit value. Input range: Range and units of Output Scale/OUT_SCALE (→ 211) Factory setting: -INF

Analog Input Block	
Parameter	Description
Low Low Priority/ LO_LO_PRI Entry Index: 31 Data type: unsigned8 Access: auto, man, OOS	Specify how the system should react if the Low Low Limit/LO_LO_LIM limit value (→ 216) is undershot. Input range: <ul style="list-style-type: none"> ▪ 0...15 ▪ 0: The alarm is suppressed. ▪ 1: The alarm is detected by the system. No notification is issued. ▪ 2: Reserved for block alarms. ▪ 3-7: Informative alarm with increasing priority, 3: Low priority, 7: High priority ▪ 8-15: Critical alarm with increasing priority, 8: Low priority, 15: High priority Factory setting: 0
Low Low Limit/ LO_LO_LIM Entry Index: 32 Data type: float Access: auto, man, OOS	Enter lower critical limit value. Input range: Range and units of Output Scale/OUT_SCALE (→ 216) Factory setting: -INF
Low Low Alarm/ LO_LO_ALM Display, selection Index: 33 Data type: DS-71 Access: auto, man, OOS	Status display for the Low Low Limit/LO_LO_LIM limit value (→ 216).
High High Alarm/ HI_HI_ALM Display, selection Index: 33 Data type: DS-71 Access: auto, man, OOS	Status display for the High High Limit/HI_HI_LIM limit value (→ 215).
High Alarm/HI_ALM Display, selection Index: 34 Data type: DS-71 Access: auto, man, OOS	Status display for the High Limit/HI_LIM limit value (→ 215).
Low Alarm/LO_ALM Display, selection Index: 35 Data type: DS-71 Access: auto, man, OOS	Status display for the Low Limit/LO_LIM limit value (→ 215).

Analog Input Block	
Parameter	Description
<p>Fsafe type/ FSAFE_TYPE Options</p> <p>Index: 37 Data type: unsigned8 Access: man, OOS</p>	<p>If the Analog Input Block receives an input value or simulation value with the status BAD, the Analog Input Block continues working with the failsafe mode defined by means of this parameter.</p> <p>The following options are available by means of the Fsafe type/FSAFE_TYPE parameter:</p> <ul style="list-style-type: none"> ■ Last Good Value The last valid value is used for further processing with the status UNCERTAIN. ■ Fail Safe Value The value specified by means of the Fsafe value/FSAFE_VALUE parameter is used for further processing with the status UNCERTAIN. → See this table, Fsafe type/FSAFE_TYPE parameter description. ■ Wrong Value The current value is used for further processing with the status BAD. <p></p> <p>The failsafe mode is also activated if the "Out of service" option was selected by means of the Block Mode/MODE_BLK parameter, "Target" element.</p> <p>Factory setting: Fail Safe Value</p>
<p>Fsafe value/ FSAFE_VALUE Entry</p> <p>Index: 38 Data type: float Access: wr for Auto, OOS, Man</p>	<p>Enter the value for the "Fail Safe Value" option selected via the Fsafe type/FSAFE_TYPE parameter. → See also this table, Fsafe type/FSAFE_TYPE parameter description.</p> <p>Factory setting: 0</p>
<p>High High Alarm Output Discrete/ HIHI_ALM_OUT_D</p> <p>Index: 39 Data type: DS66 Access: wr for Auto, OOS, Man</p>	<p>Digital outputs (1 or 0) for limit value monitoring. If the Process Value/PV ≥ High High Limit/HI_HI_LIM, the output is set to "1".</p>
<p>High alarm output discrete/ HI_ALM_OUT_D</p> <p>Index: 40 Data type: DS66 Access: wr for Auto, OOS, Man</p>	<p>Digital outputs (1 or 0) for limit value monitoring. If the Process Value/PV ≥ High Limit/HI_LIM, the output is set to "1".</p>
<p>Low alarm output discrete/ LO_ALM_OUT_D</p> <p>Index: 41 Data type: DS66 Access: wr for Auto, OOS, Man</p>	<p>Digital outputs (1 or 0) for limit value monitoring. If the Process Value/PV ≤ Low Low Limit/LO_LO_LIM, the output is set to "1".</p>
<p>Low Low Alarm Output Discrete/LOLO_ALM_OUT_D</p> <p>Index: 42 Data type: DS66 Access: wr for Auto, OOS, Man</p>	<p>Digital outputs (1 or 0) for limit value monitoring. If the Process Value/PV ≤ Low Limit/LO_LIM, the output is set to "1".</p>

Analog Input Block	
Parameter	Description
Select Alarm Mode/ ALARM_MODE Index: 43 Data type: DS66 Access: wr for Auto, OOS, Man	Facilitates alarm mode settings for the Alarm Output Discrete/ALM_OUT_D parameter. Options <ul style="list-style-type: none"> ▪ Low Cutoff/LOW_CUT ▪ HiHi or LoLo Alarm activates ALARM_OUT_D/HIHI_LOLO ▪ Hi or Lo Alarm activates ALARM_OUT_D/HI_LO
Alarm Output Discrete/ ALM_OUT_D Index: 44 Data type: DS-66 Access: wr for Auto, OOS, Man	The Alarm Output Discrete/ALM_OUT_D parameter comprises the 4 alarms (LO, LOLO, HI, HIHI). The 3 values make it possible to view the current, activated alarm depending on the alarm selected. Options: <ul style="list-style-type: none"> ▪ LOW_CUT alarm (default): The ALM_OUT_D output returns 1 if the LOW_CUT function restricts the measured value to 0. Otherwise the ALM_OUT_D output is 0. ▪ HIHI/LOLO collective alarm: The ALM_OUT_D output returns 1 if the measured value corresponds to the HIHI limit value or overshoots this value if the measured value corresponds to the LOLO limit value or undershoots this value. The output returns 0 if the measured value is between the limit values HIHI and LOLO. ▪ HI/LO collective alarm: The ALM_OUT_D output returns 1 if the measured value corresponds to the HI limit value or overshoots this value if the measured value corresponds to the LO limit value or undershoots this value. The output returns 0 if the measured value is between the limit values HI and LO.
Block Error Description/ BLOCK_ERR_DESC_1 Index: 45 Data type: unsigned32 Access: wr for Auto, OOS, Man	Detailed description of the errors that occur within the block. Error messages: <ul style="list-style-type: none"> ▪ RS_BLOCK in OOS ▪ Block not scheduled ▪ Channel undefined ▪ L-Type undefined ▪ AI / TRD unit inconsistent

9.12.5 Backup or duplicate device data

The device has no memory module. With an operating tool based on FDT technology (e.g. FieldCare), you have the following options (see parameter "**Download select**" →  119 in operating menu or via Resource block →  173):

- Saving/rescuing configuration data
- Duplicating instrument configurations
- Transferring all relevant parameters when replacing electronic inserts.

For more information, read the operating manual for the FieldCare operating program.

10 Maintenance

Deltabar M requires no maintenance.

For Cerabar M and Deltapilot M keep the pressure compensation and GORE-TEX® filter (1) free from contamination.

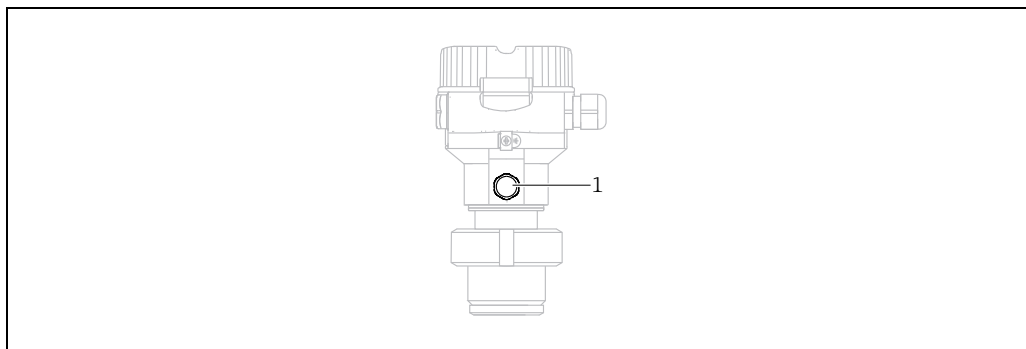

A0028502

10.1 Cleaning instructions

Endress+Hauser offer flushing rings as accessories to clean process isolating diaphragms without taking the transmitters out of the process.

For further information please contact your local Endress+Hauser Sales Center.

10.1.1 Cerabar M PMP55

We recommend you perform CIP (cleaning in place (hot water)) before SIP (sterilization in place (steam)) for pipe diaphragm seals. A frequent use of sterilization in place (SIP) will increase the stress on the process isolating diaphragm. Under unfavorable circumstances in the long term view we cannot exclude that a frequent temperature change could lead to a material fatigue of the process isolating diaphragm and possibly to a leakage.

10.2 Exterior cleaning

Please note the following points when cleaning the device:

- The cleaning agents used should not corrode the surface and the seals.
- Mechanical damage to the process isolating diaphragm, e.g. due to pointed objects, must be avoided.
- Observe the degree of protection of the device. See the nameplate if necessary (→ 8 ff).

11 Troubleshooting

11.1 Messages

The following table lists the messages that can occur. The Diagnostic code/ACTUAL_HIGHEST_ALARM parameter displays the message with the highest priority. The device has four different status information codes according to NE107:

- F = failure
- M (warning) = maintenance required
- C (warning) = function check
- S (warning) = out of specification (deviations from the permitted ambient or process conditions determined by the device with the self-monitoring function, or errors in the device itself indicate that the measuring uncertainty is greater than what would be expected under normal operating conditions).

Message display:

- Local operation:
 - The measured value display shows the message with the highest priority.
 - The Diagnostic code/ACTUAL_HIGHEST_ALARM parameter displays all messages present in descending order of priority. You can scroll through all the messages pending using the S or O key.
- FieldCare:
 - The Diagnostic code/ACTUAL_HIGHEST_ALARM parameter displays the message with the highest priority.
 - See the "Priority" column.
- Diagnostic Transducer Block (FF configuration program):
 - The Diagnostic code/ACTUAL_HIGHEST_ALARM parameter displays the message with the highest priority. Every message is also output as per the FOUNDATION Fieldbus Specification by means of the Transducer error/XD_ERROR and Block error/BLOCK_ERROR parameters.
 - Numbers are given for these parameters in the following table which are explained → 224.
- You can view a list of the active alarms via the Diagnostic code/ACTUAL_HIGHEST_ALARM parameter.
- You can view a list of alarms which are no longer active (event log) via the Last diag. code/ LAST_ALARM_INFOS parameter.

Diagnostic code	Error message	XD_ERROR Value	BLOCK_ERROR bits	Cause	Measure
0	No error	–	–	–	–
C484	Error simul.	17	0	– Fault state simulation is switched on, i.e. the device is not measuring at present.	End the simulation
C485	Measure simul.	17	0	– Simulation is switched on, i.e. the device is not measuring at present.	End the simulation
C824	Process pressure	20	8	– Overpressure or low pressure present. – Electromagnetic effects are greater than specifications in the technical data. This message normally only appears briefly.	1. Check the pressure value 2. Restart the device 3. Perform a reset
F002	Sens. unknown	20	8	– Sensor does not suit the device (electronic sensor nameplate).	Contact Endress+Hauser Service
F062	Sensor conn.	20	8	– Cable connection between sensor and main electronics disconnected. – Sensor defect. – Electromagnetic effects are greater than specifications in the technical data.	1. Check sensor cable 2. Replace electr. 3. Contact Endress+Hauser Service 4. Replace sensor (snap-on Version)

Diagnostic code	Error message	XD_ERROR Value	BLOCK_ERROR bits	Cause	Measure
F081	Initialization	20	8	<ul style="list-style-type: none"> - Cable connection between sensor and main electronics disconnected. - Sensor defect. - Electromagnetic effects are greater than specifications in the technical data. This message normally only appears briefly. 	<ol style="list-style-type: none"> 1. Perform a reset 2. Check sensor cable 3. Contact Endress+Hauser Service
F083	Permanent mem.	20	8	<ul style="list-style-type: none"> - Sensor defect. - Electromagnetic effects are greater than specifications in the technical data. This message normally only appears briefly. 	<ol style="list-style-type: none"> 1. Restart the device 2. Contact Endress+Hauser Service
F140	Working range P	20	8	<ul style="list-style-type: none"> - Overpressure or low pressure present. - Electromagnetic effects are greater than specifications in the technical data. - Sensor defect. 	<ol style="list-style-type: none"> 1. Check the process pressure 2. Check the sensor range
F261	Electronics	20	8	<ul style="list-style-type: none"> - Main electronics defective. - Fault in the main electronics. 	<ol style="list-style-type: none"> 1. Restart the device 2. Replace electr.
F282	Data memory	20	9	<ul style="list-style-type: none"> - Fault in the main electronics. - Main electronics defective. 	<ol style="list-style-type: none"> 1. Restart the device 2. Replace electr.
F283	Permanent mem.	23	11	<ul style="list-style-type: none"> - Main electronics defective. - Electromagnetic effects are greater than specifications in the technical data. - The supply voltage is disconnected when writing. - An error occurred when writing. 	<ol style="list-style-type: none"> 1. Perform a reset 2. Replace electr.
F510	Linearization	19	13	<ul style="list-style-type: none"> - The linearization table is being edited. 	<ol style="list-style-type: none"> 1. Conclude entries 2. Select "linear"
F511	Linearization	19	13	<ul style="list-style-type: none"> - The linearization table consists of less than 2 points. 	<ol style="list-style-type: none"> 1. Table too small 2. Corr. table 3. Accept the table
F512	Linearization	19	13	<ul style="list-style-type: none"> - The linearization table is not monotonic increasing or decreasing. 	<ol style="list-style-type: none"> 1. Tab. not monotonic 2. Corr. table 3. Accept the table
F841	Sensor range	17	8	<ul style="list-style-type: none"> - Overpressure or low pressure present. - Sensor defect. 	<ol style="list-style-type: none"> 1. Check the pressure value 2. Contact Endress+Hauser Service
F882	Input signal	22	0	<ul style="list-style-type: none"> - External measured value is not received or displays a failure status. 	<ol style="list-style-type: none"> 1. Check the bus 2. Check source device 3. Check the setting
M002	Sens. unknown	17	8	<ul style="list-style-type: none"> - Sensor does not suit the device (electronic sensor nameplate). Device continues measuring. 	Contact Endress+Hauser Service
M283	Permanent mem.	23	11	<ul style="list-style-type: none"> - Cause as indicated for F283. - Correct measurement can continue as long as you do not need the peakhold indicator function. 	<ol style="list-style-type: none"> 1. Perform a reset 2. Replace electr.
M402	Initialization	23	11	<ul style="list-style-type: none"> - Cause as indicated for F283. - Correct measurement can continue as long as you do not need the setpoint function of the FF function blocks. 	<ol style="list-style-type: none"> 1. Wait 2 minutes 2. Restart the device 3. Contact Endress+Hauser Service
M434	Scaling	18	13	<ul style="list-style-type: none"> - Values for calibration (e.g. lower range value and upper range value) are too close together. - Lower range value and/or upper range value undershoot or overshoot the sensor range limits. - The sensor was replaced and the customer-specific configuration does not suit the sensor. - Unsuitable download carried out. 	<ol style="list-style-type: none"> 1. Check the measuring range 2. Check the setting 3. Contact Endress+Hauser Service

Diagnostic code	Error message	XD_ERROR Value	BLOCK_ERROR bits	Cause	Measure
M438	Data record	23	10	<ul style="list-style-type: none"> - The supply voltage is disconnected when writing. - An error occurred when writing. 	<ol style="list-style-type: none"> 1. Check setting 2. Restart the device 3. Replace electr.
M472	Buffer	17	6	<ul style="list-style-type: none"> - Writing too often to EEPROM 	<ul style="list-style-type: none"> - Reduce write accessing to EEPROM.
M515	Configuration Flow	18	13	<ul style="list-style-type: none"> - Max. flow out of nominal range of sensor 	<ol style="list-style-type: none"> 1. Recalibrate the device 2. Restart the device
M882	Input signal	22	0	<ul style="list-style-type: none"> - External measured value displays a warning status. 	<ol style="list-style-type: none"> 1. Check the bus 2. Check source device 3. Check the setting
S110	Working range T	20	8	<ul style="list-style-type: none"> - Over temperature and low temperature present. - Electromagnetic effects are greater than specifications in the technical data. - Sensor defect. 	<ol style="list-style-type: none"> 1. Check proc. temp. 2. Check temperature range
S140	Working range P	20	8	<ul style="list-style-type: none"> - Overpressure and low pressure present. - Electromagnetic effects are greater than specifications in the technical data. - Sensor defect. 	<ol style="list-style-type: none"> 1. Check the process pressure 2. Check the sensor range
S822	Process temp.	17	8	<ul style="list-style-type: none"> - The temperature measured in the sensor is greater than the upper nominal temperature of the sensor. - The temperature measured in the sensor is lower than the lower nominal temperature of the sensor. 	<ol style="list-style-type: none"> 1. Check the temperature 2. Check the setting
S841	Sensor range	17	8	<ul style="list-style-type: none"> - Overpressure or low pressure present. - Sensor defect. 	<ol style="list-style-type: none"> 1. Check the pressure value 2. Contact Endress+Hauser Service

Explanation of XD_ERROR and BLOCK_ERROR

- F = failure
- M (warning) = maintenance required
- C (warning) = function check
- S (warning) = out of specification (deviations from the permitted ambient or process conditions determined by the device with the self-monitoring function, or errors in the device itself indicate that the measuring uncertainty is greater than what would be expected under normal operating conditions).

Error type	Code	XD_ERROR Value	XD_ERROR Text	BLOCK_ERROR bits	BLOCK_ERROR Text	PV Status
F (failure)	2, 62, 81, 83	20	Electronics failure	8	Sensor failure	Bad Sensor failure
	140	20	Electronics failure	8	Sensor failure	Bad Sensor failure
	261, 282	20	Electronics failure	9	Memory failure	Bad Device failure
	283	23	Data integrity error	11	Lost NV data	Bad Device failure
	510, 511, 512	19	Configuration error	13	Device needs maintenance now	Bad Configuration error
	841	17	General error	8	Sensor failure	Bad Sensor failure
	882	22	I/O failure	0	Other	Bad Non-specific
(M) warning	2	17	General error	8	Sensor failure	Uncertain non-specific
	283, 402	23	Data integrity error	11	Lost NV data	Uncertain non-specific
	434, 515	18	Calibration error	13	Device needs maintenance now	Uncertain non-specific
	438	23	Data integrity error	10	Lost static data	Uncertain non-specific
	472	17	General error	6	Device needs maintenance soon	Uncertain non-specific
	882	22	I/O failure	0	Other	Uncertain sub-normal
(C) warning	484, 485	17	General error	0	Other	Uncertain non-specific
	824	20	Electronics failure	8	Sensor failure	Uncertain Non-specific
(S) warning	110	20	Electronics failure	8	Sensor failure	Uncertain Sensor conversion not accurate
	140	20	Electronics failure	8	Sensor failure	Uncertain Sensor conversion not accurate
	822	17	General error	8	Sensor failure	Uncertain Sensor conversion not accurate
	841	17	General error	8	Sensor failure	Uncertain Sensor conversion not accurate

11.1.1 Onsite display error messages

If the device detects a defect in the onsite display during initialization, the following error messages can be displayed:

Message	Measure
Initialization, VU Electr. Defect A110	Exchange onsite display.
Initialization, VU Electr. Defect A114	
Initialization, VU Electr. Defect A281	
Initialization, VU Checksum Err. A110	
Initialization, VU Checksum Err. A112	
Initialization, VU Checksum Err. A171	

11.2 Response of outputs to errors

The device makes a distinction between the message types F (failure) and M, S, C (warning).
 → See the following table and →  221, Section 11.1 "Messages".

Output	F (failure)	M, S, C (warning)
FOUNDATION Fieldbus (FF configuration program/FieldCare)	The process variable in question is transmitted with the status BAD.	Device continues measuring. The process variable in question is transmitted with the status UNCERTAIN.
Onsite display	<ul style="list-style-type: none"> - The measured value and message are displayed alternately - Measured value display: F-symbol is permanently displayed. 	<ul style="list-style-type: none"> - The measured value and message are displayed alternately - Measured value display: M, S, or C-symbol flashes.

11.2.1 Analog Input Block

If the Analog Input Block receives an input value or simulation value with the status BAD, the Analog Input Block continues working with the failsafe mode defined by means of the Fsafe type/FSAFE_TYPE¹ parameter.

The following options are available by means of the Fsafe type/FSAFE_TYPE parameter:

- Last Good Value
The last valid value is used for further processing with the status UNCERTAIN.
- Fail SafeValue
The value specified by means of the Fsafe value/FSAFE_VALUE¹ parameter is used for further processing with the status UNCERTAIN.
- Wrong Value
The current value is used for further processing with the status BAD.

Factory setting:

- Fsafe type/FSAFE_TYPE: FsafeValue
- Fsafe value/FSAFE_VALUE: 0



The failsafe mode is also activated if the "Out of service" option was selected by means of the Block Mode/MODE_BLK parameter, "Target" element.

¹ These parameters are not available by means of FieldCare.

11.3 Repair

The Endress+Hauser repair concept provides for measuring devices to have a modular design and that the customer can also carry out repairs (see →  226, Section 11.5 "Spare Parts").

- For certified devices, please see the "Repair of Ex-certified devices" section.
- For more information on service and spare parts, contact Endress+Hauser Service.
→ See www.endress.com/worldwide.

11.4 Repair of Ex-certified devices

WARNING

Limitation of electrical safety due to incorrect connection!

Risk of explosion!

When repairing Ex-certified devices, please note the following:

- Only specialist personnel or Endress+Hauser may repair certified devices.
- Relevant standards, national hazardous area regulations and safety instructions and certificates must be observed.
- Only genuine Endress+Hauser spare parts may be used.
- When ordering spare parts, please check the device designation on the nameplate. Identical parts may only be used as replacements.
- Electronic inserts or sensors already in use in a standard device may not be used as spare parts for a certified device.
- Carry out repairs according to the instructions. Following a repair, the device must fulfill the requirements of the specified individual tests.
- A certified device may only be converted to another certified device version by Endress+Hauser.
- All repairs and modifications must be documented.

11.5 Spare Parts

- Some replaceable measuring device components are identified by means of a spare part nameplate. This contains information about the spare part.
- All the spare parts for the measuring device along with the order code are listed in the W@M Device Viewer (www.endress.com/deviceviewer) and can be ordered. If available, users can also download the associated Installation Instructions.



Measuring device serial number:

- Located on the device and spare part nameplate.
- Can be read out via the "Serial number" parameter in the "Instrument info" submenu.

11.6 Return

The measuring device must be returned if repairs or a factory calibration are required, or if the wrong measuring device has been ordered or delivered. According to legal regulations, Endress+Hauser, as a ISO-certified company, is required to follow certain procedures when handling returned products that are in contact with process fluids.

To ensure swift, safe and professional device returns, please read the return procedures and conditions on the Endress+Hauser website at www.services.endress.com/return-material.

11.7 Disposal

When disposing, separate and recycle the device components based on the materials.

11.8 Software history

Device	Date	Software version	Software modifications	Operating Instructions
Cerabar M	12.2010	01.00.zz	Original software. Compatible with: - FieldCare from version 2.08.00 - Field Communicator DXR375 with Device Rev.: 1, DD Rev.: 1	BA00384P/00/EN/01.11 71089568
				BA00384P/00/EN/02.11 71134596
				BA00384P/00/EN/03.11 71134885
				BA00384P/00/EN/04.12 71157189
				BA00384P/00/EN/05.12 71191310
				BA00384P/00/EN/06.14 71241506
				BA00384P/00/EN/07.14 71270337
				BA00384P/00/EN/08.16 71316874

Device	Date	Software version	Software modifications	Operating Instructions
Deltabar M	12.2010	01.00.zz	Original software. Compatible with: - FieldCare from version 2.08.00 - Field Communicator DXR375 with Device Rev.: 1, DD Rev.: 1	BA00384P/00/EN/01.11 71089568
				BA00384P/00/EN/02.11 71134596
				BA00384P/00/EN/03.11 71134885
				BA00384P/00/EN/04.12 71157189
				BA00384P/00/EN/05.12 71191310
				BA00384P/00/EN/06.14 71241506
				BA00384P/00/EN/07.14 71270337
				BA00384P/00/EN/08.16 71316874

Device	Date	Software version	Software modifications	Operating Instructions
Deltapilot M	12.2010	01.00.zz	Original software. Compatible with: – FieldCare from version 2.08.00 – Field Communicator DXR375 with Device Rev.: 1, DD Rev.: 1	BA00384P/00/EN/01.11 71089568
				BA00384P/00/EN/02.11 71134596
				BA00384P/00/EN/03.11 71134885
				BA00384P/00/EN/04.12 71157189
				BA00384P/00/EN/05.12 71191310
				BA00384P/00/EN/06.14 71241506
				BA00384P/00/EN/07.14 71270337
				BA00384P/00/EN/08.16 71316874

12 Technical data

For the technical data, please refer to the Technical Information for Cerabar M TI00436P / Deltabar M TI00434P / Deltapilot M TI00437P.

Index

A

- Alarm messages 221
- Arbeitssicherheit 6
- Assignment of Transducer Blocks (CHANNEL) 63

B

- Basic safety instructions 6
- Block configuration, delivery status 61, 165
- Block model, Deltabar S 59

C

- Cable specification 39

D

- Designated use 6
- Device addressing 58
- Device identification 58
- Diaphragm seals, installation instructions 17
- Diaphragm seals, vacuum application 18
- Differential pressure measurement, installation 28
- Differential pressure measurement, preparatory steps 91
- Display 49

E

- Electrical connection 38
- Error messages 221

F

- Factory setting 55
- FieldCare 53
- Flow measurement 93
- Flow measurement, installation 24
- Flow measurement, preparatory steps 94
- FOUNDATION Fieldbus system architecture 56

G

- General structure of the operating menu 48

H

- Hazardous area 7

I

- Index tables 65
- Installation instructions 32
- Installation instructions for devices with diaphragm seals 17
- Installation instructions for devices without diaphragm seals 14

K

- Keys, local, function 47, 51
- Keys, local, pressure measuring mode 69

L

- Language selection 71–72, 142
- Level measurement 16, 74, 146
- Level measurement, installation 26

- Level measurement, preparatory steps 96
- Linearization 84, 159
- Local display 49
- Locking operation 47, 54

M

- Measuring arrangement for pressure measurement 15–16
- Measuring layout for flow measurement 25
- Measuring layout for level measurement 26
- Measuring layout for pressure measurement 28
- Measuring mode selection 71–72, 142
- Methods 68
- Mounting, suspension clamp 34

N

- Nameplate 8
- Network configuration 57
- Number of devices 57

O

- Operating elements, function 47, 51
- Operating elements, position 46
- Operating keys, position 46
- Operational safety 6
- Overvoltage protection 41

P

- Pipe mounting 21, 29, 35
- Pos. Zero Adjust 73, 144
- Position adjustment, onsite 47
- Potential equalization 40
- Product safety 7

R

- Repair 226
- Repair of Ex-certified devices 226
- Reset 55
- Returning devices 226

S

- Scaling OUT parameter 141
- Scope of delivery 11
- Separate housing, assembly and mounting 22, 36
- Shielding 40
- Simulation 54
- Software history 227
- Spare Parts 226
- Storage 12
- Supply voltage 39

T

- Temperature isolator, installation instructions 19
- Troubleshooting 221

U

- Unlocking operation 47, 54

W

Wall and pipe-mounting	29
Wall mounting	21, 35
Warnings	221
Welding recommendation	23



71316874

www.addresses.endress.com
