

# Operating Instructions

## CM14

Transmitter, oxygen content

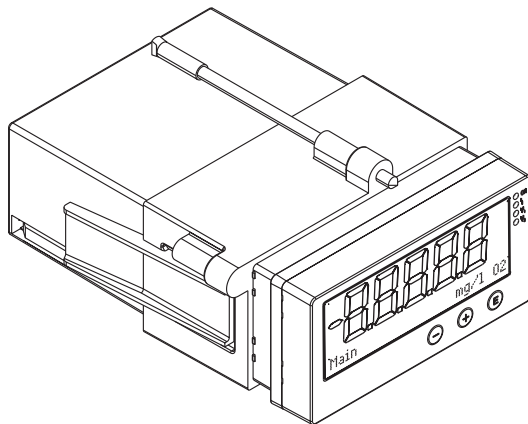



# Table of contents

<b>1</b>	<b>Safety instructions</b>	<b>4</b>	<b>7</b>	<b>Calibration</b>	<b>23</b>
1.1	Workplace safety	4	7.1	Definitions	24
1.2	Requirements concerning the staff	4	7.2	Device functions for calibration	26
1.3	Operational safety	4	<b>8</b>	<b>Maintenance</b>	<b>26</b>
1.4	Designated use	5	<b>9</b>	<b>Accessories</b>	<b>27</b>
1.5	Technical improvement	5	9.1	Sensors	27
1.6	Return	5	<b>10</b>	<b>Troubleshooting</b>	<b>28</b>
1.7	Notes on safety conventions and icons	5	10.1	Troubleshooting instructions	28
<b>2</b>	<b>Identification</b>	<b>7</b>	10.2	Diagnostic messages	28
2.1	Device name	7	10.3	Firmware history	32
2.2	Scope of delivery	7	10.4	Spare parts	32
2.3	Certificates and approvals	8	10.5	Return	33
<b>3</b>	<b>Installation</b>	<b>9</b>	10.6	Disposal	33
3.1	Incoming acceptance, transport, storage	9	<b>11</b>	<b>Technical data</b>	<b>33</b>
3.2	Installation	9	11.1	Input	33
3.3	Dimensions	9	11.2	Output	34
3.4	Installation procedure	10	11.3	Current outputs, active	34
3.5	Post-installation check	10	11.4	Relay outputs	35
<b>4</b>	<b>Wiring</b>	<b>11</b>	11.5	Wiring	35
4.1	Connecting the transmitter	12	11.6	Performance characteristics	36
4.2	Post-connection check	13	11.7	Mounting conditions	37
<b>5</b>	<b>Operation</b>	<b>14</b>	11.8	Environment	37
5.1	Display and device status indicator / LED	14	11.9	Mechanical construction	38
5.2	Local operation at the device	14	11.10	Display and operating elements	39
5.3	Icons	15	11.11	Certificates and approvals	40
5.4	Operating functions	16	<b>Index</b>	<b>41</b>	
5.5	Hold function	16			
<b>6</b>	<b>Commissioning</b>	<b>17</b>			
6.1	Post-installation check and switching on the device	17			
6.2	Display settings (Display menu)	17			
6.3	Notes on setup access protection	17			
6.4	Configuration of the device (Setup menu)	18			
6.5	Extended configuration (Extended setup menu)	19			
6.6	Device diagnostics (Diagnostics menu)	22			

# 1 Safety instructions

Safe operation of the transmitter is only guaranteed if these Operating Instructions have been read and the safety instructions have been observed.

## 1.1 Workplace safety

For work on and with the device:

- ▶ Wear the required personal protective equipment according to federal/national regulations.

If working on and with the device with wet hands:

- ▶ Due to the increased risk of electric shock, gloves must be worn.

## 1.2 Requirements concerning the staff

The personnel for installation, commissioning, diagnostics and maintenance must fulfill the following requirements:

- ▶ Trained, qualified specialists: must have a relevant qualification for this specific function and task
- ▶ Are authorized by the plant owner/operator
- ▶ Are familiar with federal/national regulations
- ▶ Before beginning work, the specialist staff must have read and understood the instructions in the Operating Instructions and supplementary documentation as well as in the certificates (depending on the application)
- ▶ Following instructions and basic conditions

The operating personnel must fulfill the following requirements:

- ▶ Being instructed and authorized according to the requirements of the task by the facility's owner-operator
- ▶ Following the instructions in these Operating Instructions

## 1.3 Operational safety

Risk of injury.

- ▶ Operate the device in proper technical condition and fail-safe condition only.
- ▶ The operator is responsible for interference-free operation of the device.

### Conversions to the device

Unauthorized modifications to the device are not permitted and can lead to unforeseeable dangers.

- ▶ If, despite this, modifications are required, consult with Endress+Hauser.

### Repair

To ensure continued operational safety and reliability,

- ▶ Carry out repairs on the device only if they are expressly permitted.
- ▶ Observe federal/national regulations pertaining to repair of an electrical device.
- ▶ Use original spare parts and accessories from Endress+Hauser only.

## 1.4 Designated use

The transmitter evaluates measured values of an analytical sensor and visualizes them on its multicolored display. Processes can be monitored and controlled with the unit's outputs and limit relays. The device is equipped with a wide array of software functions for this purpose.

- The manufacturer does not accept liability for damage caused by improper or non-designated use. The device may not be converted or modified in any way.
- The device is designed for installation in a panel and must only be operated in an installed state.

## 1.5 Technical improvement

The manufacturer reserves the right to adapt technical details to the most up-to-date technical developments without any special announcement. Please contact your sales center for information on modifications or updates to the Operating Instructions.

## 1.6 Return

For a return, e.g. in case of repair, the device must be sent in protective packaging. The original packaging offers the best protection. Repairs must only be carried out by your supplier's service organization.



When returning the device for repair, enclose a note with a description of the problem and the application.

## 1.7 Notes on safety conventions and icons

### 1.7.1 Warnings



#### Causes (/consequences)

Consequences of non-compliance (if applicable)

- ▶ Corrective action
- ▶ This symbol alerts you to a dangerous situation. Failure to avoid the situation will result in a fatal or serious injury.



#### Causes (/consequences)

Consequences of non-compliance (if applicable)

- ▶ Corrective action
- ▶ This symbol alerts you to a dangerous situation. Failure to avoid the situation can result in a fatal or serious injury.



#### Causes (/consequences)

Consequences of non-compliance (if applicable)







- ▶ Corrective action
- ▶ This symbol alerts you to a dangerous situation. Failure to avoid this situation can result in minor or more serious injuries.

**NOTICE****Causes (/consequences)**

Consequences of non-compliance (if applicable)

- ▶ Corrective action
- ▶ This symbol alerts you to situations which may result in damage to property.

**1.7.2 Document symbols**

- |   |   |
|---|---|
|  | Allowed<br>Indicates procedures, processes or actions that are allowed.     |
|  | Preferred<br>Indicates procedures, processes or actions that are preferred. |
|  | Forbidden<br>Indicates procedures, processes or actions that are forbidden. |
|  | Additional information, tips  |
|  | Reference to documentation  |
|  | Reference to a page in this manual  |
|  | Reference to a graphic  |

## 2 Identification

### 2.1 Device name

#### 2.1.1 Nameplate

Compare the nameplate with the following diagram:

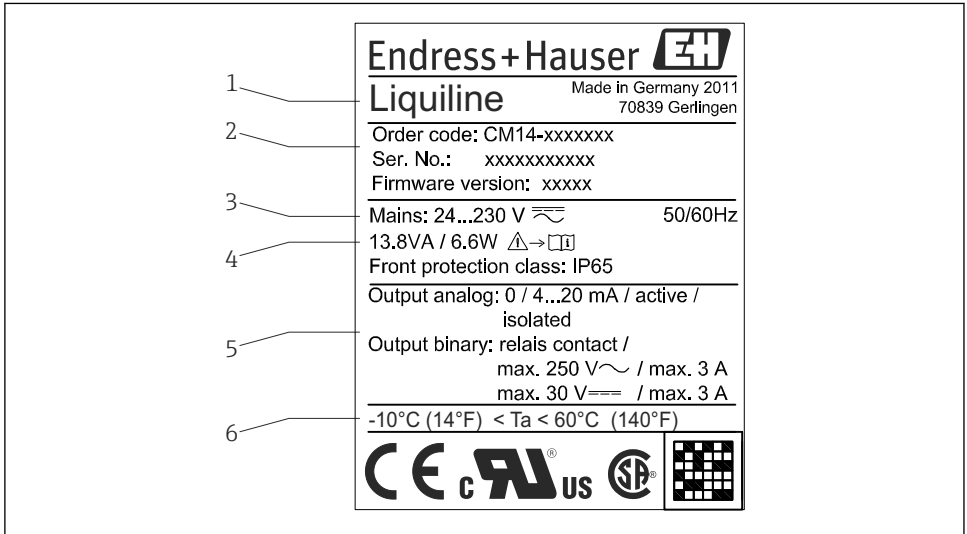

A0015221

#### 1 Nameplate of the transmitter (example)

- 1 Device name
- 2 Device order code, serial number and ID number
- 3 Power supply
- 4 Power consumption
- 5 Output values
- 6 Temperature range

### 2.2 Scope of delivery

The scope of delivery of the transmitter comprises:

- Transmitter for panel mounting
- Operating Instructions
- Fastening fixtures

## **2.3 Certificates and approvals**

### **2.3.1 CE mark**

The product meets the requirements of the harmonized European standards. As such, it complies with the legal specifications of the EC directives. The manufacturer confirms successful testing of the product by affixing to it the CE-mark.

### **2.3.2 EAC mark**

The product meets the legal requirements of the EEU guidelines. The manufacturer confirms the successful testing of the product by affixing the EAC mark.



## 3 Installation

### 3.1 Incoming acceptance, transport, storage

The permitted ambient and storage conditions must be observed. The precise specifications can be found in Section "Technical data" →  33.

#### 3.1.1 Incoming acceptance

On receipt of the goods, check the following points:

- Are the packaging or contents damaged?
- Is anything missing from the delivery? Compare the scope of delivery with the information you specified in the order.

#### 3.1.2 Transportation and storage

Note the following points:

- Pack the device so that is protected against impact for storage and transportation. The original packaging provides optimum protection.
- The permitted storage temperature range is  $-40$  to  $+85$  °C ( $-40$  to  $+185$  °F); it is possible to store the device in the borderline temperature ranges for a limited period (maximum 48 hours).

## 3.2 Installation

### NOTICE

#### Overheating due to heat accumulation in the device

- ▶ To avoid heat accumulation, please always make sure the device is sufficiently cooled.



If the device is operated in the upper temperature limit range, this reduces the operating life of the display.

The transmitter is designed to be used in a panel.

The orientation is determined by the readability of the display. Connections and outputs are fitted on the rear of the device. The wires are connected by means of number-coded terminals.

Ambient temperature range:  $-10$  to  $+60$  °C ( $14$  to  $140$  °F)

## 3.3 Dimensions

Observe the installation depth of 150 mm (5.91 ") for the device incl. terminals and fastening clips.

More dimensions can be found in Section "Technical data" →  33.

- Panel cutout: 92 mm x 45 mm (3.62 in x 1.77 in).
- Panel thickness: max. 26 mm (1 in).
- Max. viewing angle range:  $45^\circ$  to the left and right from the central display axis.
- If the devices are arranged horizontally beside one another in the X-direction, or arranged vertically on top of one another in the Y-direction, the mechanical distance (specified by the housing and front section) must be observed.

### 3.4 Installation procedure

The required panel cutout is 92 mm x 45 mm (3.62 in x 1.77 in).

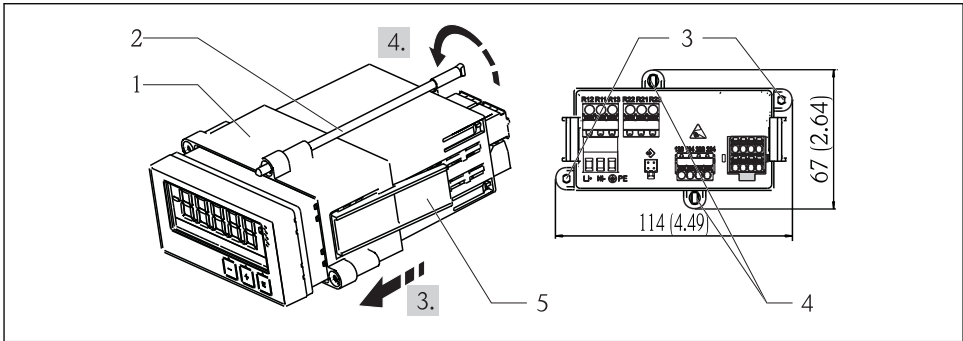

A0015216

#### 2 Installation in the panel

1. Screw the threaded rods (item 2) into the positions provided on the mounting frame (item 1). Four opposing screw positions (item 3/4) are available for this purpose.
2. Push the device with the sealing ring through the panel cutout from the front.
3. To secure the tube in the panel, hold the device in a horizontal position and push the installation frame (item 1), with the threaded rods screwed in, over the tube until the frame locks into position.
4. Tighten the threaded rods to fasten the device in place.

To disassemble the device, the mounting frame can be unlocked at the locking elements (item 5) and then removed.

### 3.5 Post-installation check

- Is the sealing ring undamaged?
- Is the mounting frame securely engaged on the housing of the device?
- Are the threaded rods tightened?
- Is the device positioned in the center of the panel cutout?

## 4 Wiring

### WARNING

#### **Danger from electrical voltage**

- ▶ The entire connection of the electrical system must take place while the device is de-energized.

Danger if protective ground is interrupted

- ▶ The protective ground connection must be established before any other connection is made.

### **NOTICE**

#### **Thermal load of the lines**

- ▶ Use suitable lines for temperatures of 5 °C (9 °F) above ambient temperature.

Malfunction or destruction of the device due to incorrect supply voltage

- ▶ Prior to commissioning, make sure the supply voltage matches the specifications on the nameplate (bottom side of the housing).

Ensure the emergency shutoff of the device

- ▶ Provide a suitable switch or power-circuit breaker in the building installation. This switch must be provided within easy reach of the device and be labeled as a disconnecter.

Protect device from overload

- ▶ Provide a overload protection unit (rated current = 10 A) for the power supply line.

Incorrect wiring can cause destruction of the device

- ▶ Observe the terminal designation on the rear of the device.

Energy-rich transients in long signal lines

- ▶ Connect suitable upstream overvoltage protection in series.



It is permitted to connect a mixture of safety extra low voltage and voltage which poses a shock hazard to the relays.

## 4.1 Connecting the transmitter

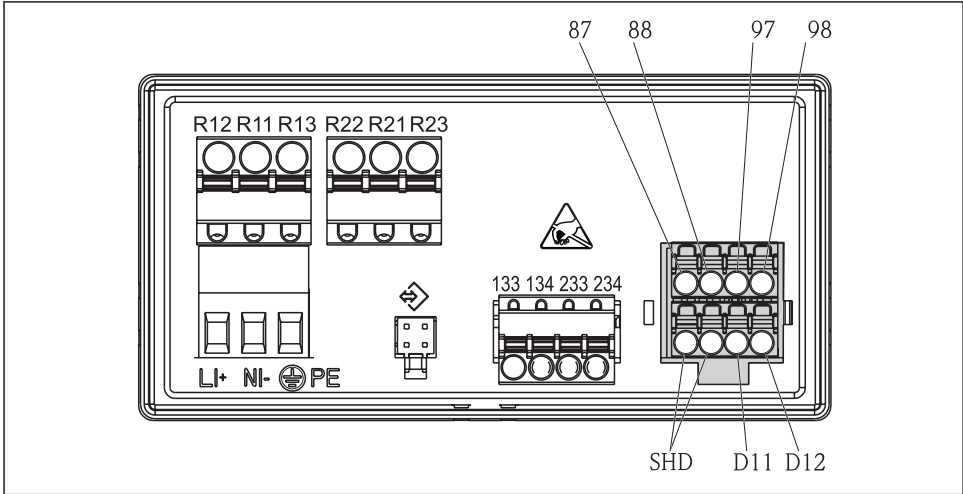



A0015215

3 Connection diagram of the transmitter

Terminal	Description
87	Terminal for Memosens cable, brown, sensor power supply U+
88	Terminal for Memosens cable, white, sensor power supply U-
97	Terminal for Memosens cable, green, Com A
98	Terminal for Memosens cable, yellow, Com B
SHD	Terminal for Memosens cable, shield
D11	Terminal for alarm output, +
D12	Terminal for alarm output, -
L/+	Terminal for transmitter supply voltage
N/-	
⊕ PE	
133	Terminal for analog output 1, +
134	Terminal for analog output 1, -
233	Terminal for analog output 2, +
234	Terminal for analog output 2, -
R11, R12, R13	Terminal for relay 1
R21, R22, R23	Terminal for relay 2

## 4.2 Post-connection check

Device condition and specifications	Notes
Are the device or cables damaged?	Visual inspection
Electrical connection	Notes
Does the supply voltage match the specifications on the nameplate?	24 to 230 V AC/DC (-20 % / +10 %) 50/60 Hz
Are all of the terminals firmly engaged in their correct slots? Is the coding on the individual terminals correct?	-
Are the mounted cables strain-relieved?	-
Are the supply voltage and signal cables connected correctly?	See connection diagram, →  3,  12 and on the housing.

## 5 Operation

The device's simple operating concept enables you to perform commissioning for many applications without the need for hardcopy operating instructions.

### 5.1 Display and device status indicator / LED

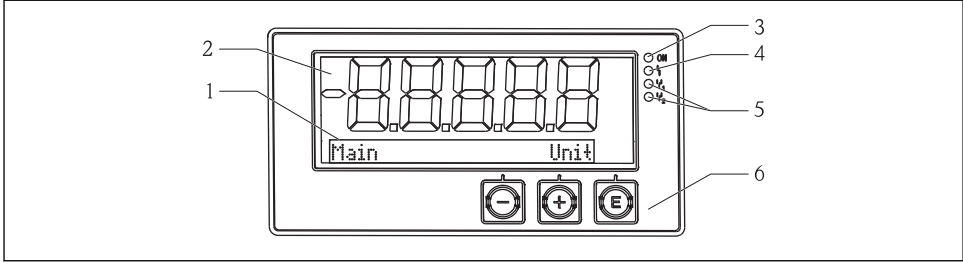

A0015891

#### 4 Device display

- 1 Dot matrix section
- 2 7-segment display
- 3 LED status indicator, power supply connected
- 4 LED status indicator, alarm function
- 5 LED status indicator, limit switch relay 1/2
- 6 Operating keys

The device offers users a backlit LC display which is divided into two sections. The segment section displays the measured value.

In the dot matrix section, additional channel information, such as the TAG, unit or bar graph, is shown in the display mode. Operating text in English is displayed here during operation.

The parameters for configuring the display are explained in detail in the "Commissioning" section.

In the event of an error, the device automatically switches between displaying the error and displaying the channel, see the "Device diagnostics" → 22 and "Troubleshooting" → 28 sections.

### 5.2 Local operation at the device

The device is operated using the three keys integrated in the front of the device





- Open the Configuration menu
- Confirm an entry
- Select a parameter or submenu offered in the menu



Within the Configuration menu:

- Gradually scroll through the parameters / menu items / characters offered
- Change the value of the selected parameter (increase or decrease)

Outside the Configuration menu:



Display enabled and calculated channels, as well as minimum and maximum values, for all the active channels.

You can always exit menu items / submenus by selecting "x Back" at the end of the menu.

Leave the setup directly without saving the changes by pressing the '-' and '+' keys simultaneously for longer (> 3 s).

## 5.3 Icons

### 5.3.1 Display symbols

	Hold function →  16 active.
Max	Maximum value/value of the maximum indicator of the channel displayed
Min	Minimum value/value of the minimum indicator of the channel displayed
-----	Error, under/over range. No measured value is displayed.
	The device is locked / operator lock; the device setup is locked for changes to parameters; the display can be changed.



The error and the channel identifier (TAG) are specified in the dot matrix section.





### 5.3.2 Icons in the editing mode

The following characters can be used to enter user-defined text:

'0-9', 'a-z', 'A-Z', '+', '-', '\*', '/', '\', %, °, '2', '3', 'm', '.', ',', ';', ':', '!', '?', '\_', '#', '\$', '"', "'", '(', ')', '~',

For numerical entries, the numbers '0-9' and the decimal point are available.

*Furthermore, the following icons are used in the editing mode:*

	Symbol for setup
	Symbol for expert setup
	Symbol for diagnostics
	Accept entry. If this symbol is selected, the entry is applied at the position specified by the user, and you quit editing mode.

✘	Reject entry. If this symbol is selected, the entry is rejected and you quit editing mode. The previously set text remains.
+	Jump one position to the left. If this symbol is selected, the cursor jumps one position to the left.
⬅	Delete backwards. If this symbol is selected, the character to the left of the cursor position is deleted.
☒	Delete all. if this symbol is selected, the entire entry is deleted.

## 5.4 Operating functions

The operating functions of the transmitter are organized into the following menus:

<b>Display</b>	Settings for the device display: contrast, brightness, time for alternating measured values on the display
<b>Setup</b>	Device settings A description of the individual settings is provided in the "Commissioning" section → 17.
<b>Calibration</b>	Execution of the sensor calibration A description of the functions for calibration is provided in the "Calibration" section.
<b>Diagnostics</b>	Device information, diagnostics logbook, sensor information, simulation

## 5.5 Hold function

The hold function causes the current outputs and relay states to "freeze". This function can be switched on and off manually (menu **Setup** → **Manual hold**). In addition, the hold function is automatically activated during sensor calibration.

When the hold condition no longer applies, the hold function continues to be active for the configurable hold release time. The hold release time is configured in the menu **Setup** → **Extended setup** → **System** → **Hold release**.

The hold function does not affect the display of the measured value. The hold symbol is also displayed after the measured value.



## 6 Commissioning

### 6.1 Post-installation check and switching on the device

Make sure that all post-connection checks have been carried out before you commission your device:

- Checklist for "post-installation check", →  10.
- Checklist for "post-connection check", →  13.

After the operating voltage is applied, the green LED lights up and the display indicates the device is ready for operation.

If you are commissioning the device for the first time, program the setup as described in the following sections of the Operating Instructions.

When commissioning a device already configured or preset, measuring is immediately started as per the settings. The values of the channels currently activated are shown on the display.



Remove the protective film from the display as this would otherwise affect the readability of the display.

### 6.2 Display settings (Display menu)

You can access the main menu by pressing the 'E' key during operation. The Display menu appears on the display. Press the 'E' key again to open this menu. Use the "x Back" option, which can be found at the bottom of each menu/submenu, to move up one level in the menu structure.

Parameters	Possible settings	Description
Contrast	1-7 Default: <b>6</b>	Setting for the display contrast.
Brightness	1-7 Default: <b>6</b>	Setting for the brightness of the display.
Alternating time	0, 3, 5, 10 sec	Switching time between the two measured values. 0 means that the values do not alternate on the display.

### 6.3 Notes on setup access protection





Access to the setup is enabled by default (factory setting) and can be locked via the setup settings.

Proceed as follows to lock the device:

1. Press **E** to enter the configuration menu.
2. Press **+** repeatedly until **Setup** is displayed.
3. Press **E** to open the **Setup** menu.
4. Press **+** repeatedly until **Extended Setup** is displayed.

5. Press **E** to open the **Extended Setup** menu; **System** is displayed.
6. Press **E** to open the **System** menu.
7. Press **+** repeatedly until **Access code** is displayed.
8. Press **E** to open the setting for access protection.
9. Set the code: press the **+** and **-** buttons to set the desired code. The access code is a four-digit number. The corresponding position of the number is displayed in plain text. Press **E** to confirm the value entered and go to the next position.
10. Confirm the last position of the code to exit the menu. The full code is displayed. Press **+** to scroll back to the last item of the **x Back** submenu and confirm this item. By confirming the point, the value is adopted and the display returns to the **Setup** level. Again select the last parameter **x Back** to also exit this submenu and return to the measured value/channel display level.

Once access protection has been successfully activated, the lock symbol appears on the display.

-  Access to the calibration function can also be locked by a code. The same procedure as that used to lock the setup is required here. To activate the code, however, in Point 7 repeatedly press **+** until **Calib Code** is displayed.
-  The **x Back** item at the end of every picklist/menu item takes the user from the submenu to the next menu level up.
-  If access protection is enabled, the device locks automatically after 600 seconds without operation. The display switches back to the operating display.
-  To enable the setup, set the setup access code in the **System Setup** to **0000** or delete the code by pressing **C**.
-  If you lose/misplace the code, a reset can only be performed by the Service Department.

## 6.4 Configuration of the device (Setup menu)

You can access the main menu by pressing the 'E' key during operation. Navigate through the available menus with the '+' and '-' keys. When the desired menu is displayed, press the 'E' key to open the menu. Use the 'x Back' option, which can be found at the bottom of each menu/submenu, to move up one level in the menu structure.

The Setup menu contains the most important settings for the operation of the device.

Parameters	Possible settings	Description
Current range	<b>4-20 mA</b> 0-20 mA	Configuration of the measuring range for the current output.
Out 1 0/4 mA	Numerical value 0.000 to 99999 <b>0.0 mg/l</b>	Physical value which corresponds to the lower range limit of the analog output. When the configured value is undershot, the current output is set to the saturation current of 0/3.8 mA.

Parameters	Possible settings	Description
Out 1 20 mA	Numerical value -0.02 to 120 <b>120 mg/l</b>	Physical value which corresponds to the upper range limit of the analog output. When the configured value is exceeded, the current output is set to the saturation current of 20.5 mA.
Out 2 0/4 mA	Numerical value -50 to 250 °C <b>0 °C</b>	Temperature which corresponds to the measuring range lower limit of the temperature input. When the configured value is undershot, the current output is set to the saturation current of 0/3.8 mA.
Out 2 20 mA	Numerical value -50 to 250 °C <b>100 °C</b>	Temperature which corresponds to the measuring range upper limit of the temperature input. When the configured value is exceeded, the current output is set to the saturation current of 20.5 mA.
Damping main value	0 to 60 s <b>0 s</b>	Configuration of the damping for low-pass filtering of the input signals.
Extended setup		Advanced settings for the device, such as the relay, limit values etc. The functions are described in the following section, →  19.
Manual hold	<b>Off, On</b>	Function for freezing the current and relay outputs

## 6.5 Extended configuration (Extended setup menu)

You can access the main menu by pressing the 'E' key during operation. Navigate through the available menus with the '+' and '-' keys. When the desired menu is displayed, press the 'E' key to open the menu. Use the "x Back" option, which can be found at the bottom of each menu/submenu, to move up one level in the menu structure.

Parameters	Possible settings	Description
System		General settings
Tag	Customized text, max. 16 characters <b>A</b>	Use this function to enter the device tag.
Temp. unit	°C °F	Setting for the temperature unit
Hold release	0 to 600 s <b>0 s</b>	Sets the time by which a device hold is extended after the hold condition is discontinued.

Parameters		Possible settings	Description
	Alarm delay	0 to 600 s <b>0 s</b>	Delay time for outputting an alarm. This suppresses alarm conditions that are present for a period that is shorter than the alarm delay time.
	Access code	0000 to 9999 Default: <b>0000</b>	User code to protect the device configuration. <b>Additional information:</b> 0000 = user code protection is disabled
	Calib Code	0000 to 9999 Default: <b>0000</b>	User code to protect the calibration function. <b>Additional information:</b> 0000 = user code protection is disabled
Input			Input settings
	Main value	<b>Conc. liquid</b> Partial pressure	Setting to specify the medium in which the measurement is performed. <b>Conc. liquid</b> for water-based media and <b>Partial pressure</b> for measurements in the gas phase
	Unit	<b>mg/l</b> , $\mu\text{g/l}$ , ppm, ppb - if Conc. liquid has been selected <b>hPa</b> - if Partial pressure has been selected	Unit of the physical value.
	Format	None, one, <b>two</b>	Number of places after decimal point for the display.
	Damping main	0 to 60 s <b>0 s</b>	Configuration of the damping for low-pass filtering of the input signals.
	Medium pressure	Altitude <b>Air pressure</b>	Setting for altitude or air pressure.
	Altitude	-300 to 4000 m <b>0 m</b>	Altitude is set if <b>Medium Pressure</b> → <b>Altitude</b> has been selected.
	Air pressure	500 to 9999 mbar <b>1013 mbar</b>	Air pressure is set if <b>Medium Pressure</b> → <b>Air pressure</b> has been selected.
	Stability crit.		Conditions for successful calibration. If the permitted difference is exceeded, the calibration will not be allowed and is canceled automatically.
	Delta signal	0.10 to 2 % <b>2 %</b>	Permitted measured value variation during calibration
	Delta temp	0.1 to 2 K <b>0.50 K</b>	Maximal permitted fluctuation in temperature
	Duration	5 to 60 s <b>5 s</b>	Timeframe within which the permitted measured value variation may not be exceeded
Process check			Checks the process settings
	Function	On, <b>Off</b>	Switch on the process check.
	Duration	1 to 240 min <b>60 min</b>	Duration of the process check

Parameters		Possible settings	Description
	Tolerance	0.01 to 20 hPa <b>0.01 hPa</b>	Bandwidth for the process check
	Calib. settings		This pressure value is used during the calibration for correct calculation.
	Medium press.	<b>Air pressure</b> Altitude	Use of the altitude or air pressure.
	Air pressure	500 to 9999 mbar <b>1 013 mbar</b>	Air pressure is set if <b>Medium Press.</b> → <b>Air pressure</b> has been selected.
	Altitude	-300 to 4 000 m <b>0 m</b>	Altitude is set if <b>Medium Press.</b> → <b>Altitude</b> has been selected.
Analog outputs			Settings for analog outputs
	Current range	<b>4-20 mA</b> 0-20 mA	Current range for analog output
	Out 1 0/4 mA	Numerical value 0.000 to 99 999 <b>0.0 mg/l O<sub>2</sub></b>	Physical value which corresponds to the lower range limit of the analog output.
	Out 1 20 mA	Numerical value 0.000 to 99 999 <b>120 mg/l O<sub>2</sub></b>	Physical value which corresponds to the upper range limit of the analog output.
	Out 2 0/4 mA	Numerical value -50 to 250 °C <b>0 °C</b>	Temperature which corresponds to the measuring range lower limit of the temperature input.
	Out 2 20 mA	Numerical value -50 to 250 °C <b>100 °C</b>	Temperature which corresponds to the measuring range upper limit of the temperature input.
Relay 1/2			Settings for the relay outputs.
	Function	<b>Off</b> , Min limit, Max limit, In band, Out band, Error	Configuration of the relay function. If Function = <b>Error</b> , no additional settings are possible.
	Assignment	<b>Main</b> , Temp	Assignment of the relay to the main input or temperature input
	Set point	Numerical value <b>0.0</b>	Setting for the limit value.
	Set point 2	Numerical value <b>0.0</b>	Only for the <b>In band</b> or <b>Out band</b> function.
	Hyst.	Numerical value <b>0.0</b>	Configuration of the hysteresis.
	Delay time	0 to 60 s <b>0 s</b>	Configuration of the delay time until the relay switches.
Factory default			Resets the device settings to the factory default settings.
	Please confirm	<b>no</b> , yes	Confirm the reset.

### 6.5.1 Configuration of the relays

The device has two relays with limit values that are either switched off or can be allocated to the input signal. The limit value is entered as a numerical value including the decimal position. The operating mode of the relays as normally open or normally closed is determined by the wiring of the changeover contact (→  35). Limit values are always assigned to a relay. Each relay can be assigned to a channel or a calculated value. In the "Error" mode, the relay functions as an alarm relay and switches each time a fault or alarm occurs.

The following settings can be made for each of the 2 limit values: assignment, limit, hysteresis, switching behavior, delay and failure mode.

## 6.6 Device diagnostics (Diagnostics menu)

You can access the main menu by pressing the 'E' key during operation. Navigate through the available menus with the '+' and '-' keys. When the desired menu is displayed, press the 'E' key to open the menu. Use the "x Back" option, which can be found at the bottom of each menu/submenu, to move up one level in the menu structure.

Parameters		Possible settings	Description
Current diag.		Read only.	Displays the current diagnostic message
Last diag.		Read only.	Displays the last diagnostic message
Diagnost logbook		Read only	Displays the last diagnostic messages
Device info		Read only.	Displays the device information
	Device tag	Read only.	Displays the device tag
	Device name	Read only.	Displays the device name
	Serial number	Read only.	Displays the serial number of the device
	Order code	Read only.	Displays the order code of the device
	FW revision	Read only.	Displays the firmware version
	ENP version	Read only.	Displays the version of the electronic nameplate
	Module ID	Read only.	Displays the module ID
	Manufact. ID	Read only.	Displays the manufacturer ID
Manufact. name		Read only.	Displays the manufacturer name
Sensor info			
	General info		General sensor information
	Order code		Displays the order code of the sensor
	Serial number		Displays the serial number of the sensor
	Device tag		Displays the tag name of the sensor
	FW version		Displays the firmware version
	HW version		Displays the hardware version

Parameters		Possible settings	Description
	Operation time		Operating time
	Operation time > 40 °C		Operating time over 40 °C
	Operation time > 80 °C		Operating time over 80 °C
	Sterile counter		The system counts the number of operating hours in which the sensor is exposed to a temperature that is typical for a sterilization. This temperature depends on the sensor.
	Calibration info		Calibration data of the last calibration
	Cal. count		Number of sensor calibrations
	Slope in pA/hPa		The (relative) slope characterizes the sensor condition.
	Delta slope		Difference in slope between the last and second-last calibration
	Temp. cal offset		
	Zero point		The zero point corresponds to the sensor signal that is measured in a medium in the absence of oxygen.
	Specification		Information on the sensor specification
	Min 0.0 hPa		
	Max 200 hPa		
	Min Temp. -5.00 °C		
	Max Temp 135 °C		
Simulation:		Certain values can be simulated for test purposes at the inputs and outputs.	
Analog Out 1			
Analog Out 2			
Relay 1			
Relay 2			
Alarm out			
Reset device		Reset sensor to factory defaults.	

## 7 Calibration

Calibrate the sensor directly after polarization.

1. Remove the sensor from the medium.
2. Clean the outside of the sensor using a damp cloth. Then dry the sensor diaphragm carefully using a paper towel for example.
3. Wait approx. 20 minutes for the sensor to adapt to the temperature of the ambient air. The sensor may not be exposed to harsh sunlight during this time.
4. Once the measured value displayed at the transmitter has stabilized, perform the calibration as described in the Operating Instructions.
5. Then re-immerses the sensor in the medium.

## 7.1 Definitions

### 7.1.1 Polarization

A fixed voltage is applied between the cathode and anode when the sensor is connected to the transmitter. The polarization current which this creates is indicated at the transmitter by a value that is initially high but gradually decreases. The value displayed must first stabilize before the sensor can be calibrated.

### 7.1.2 Calibration

During a calibration, the operator adapts the transmitter to the characteristic values of the sensor.

Normally, the sensor hardly ever needs to be calibrated. Calibration is necessary:

- After initial commissioning
- After replacing the membrane or electrolyte
- After cleaning the cathode
- Following extended operating intervals without power being supplied

The calibration can be checked cyclically or reperformed during plant monitoring routines (at typical intervals depending on experience with operating conditions).

## Calibration

You can perform two kinds of calibration: slope or zero point

Both kinds of calibration can be performed individually or in succession. If you perform both kinds of calibration, you end up with the one to which your measurement is closest.

### Slope

The (relative) slope characterizes the sensor condition. Decreasing values indicate that the electrolyte is being used up. You can control when the system prompts the user to change the electrolyte by specifying limit values which cause the system to trigger diagnostics messages.

A calibration of the slope in water vapor-saturated air is performed as follows:

1. Press "E" to call up the main menu.
2. Press the "+" button to navigate to the "Calibration" menu.
3. Press "E" to open the menu.
  - ↳ Select "Slope Air 100%"



4. Press "E" to open the menu.
  - ↳ The display shows the current slope that might be changed by the calibration.
5. Press "+".
  - ↳ Display reads "Keep sensor above water"
6. Clean and dry the sensor and position it very close to the water.
7. Press "+".
8. Display reads "wait for stable value". When the value is stable, the display changes.
  - ↳ Display reads "O2 cal air"
9. Press "+".
  - ↳ Display reads "Save Calib. Data?"
10. Press "+".
  - ↳ Display reads "Calib. successful"
11. Press "+".

Back to measuring mode.

A calibration of the zero point in oxygen-free medium (nitrogen grade N5 or sodium sulfite solution) is performed as follows:

1. Press "E" to call up the main menu.
2. Press the "+" button to navigate to the "Calibration" menu.
3. Press "E" to open the menu.
4. Press "+" to switch to "Zero point calib."
5. Press "E" to open the menu.
  - ↳ The display shows the current zero point in nA. This can change on account of the calibration.
6. Press "+".
  - ↳ Display reads "Waiting for sensor in medium"
7. Immerse the sensor in the medium.
8. Press "+".
9. Display reads "wait for stable value". When the value is stable, the display changes.
  - ↳ Display reads "Zero point"
10. Press "+".
  - ↳ Display reads "Save Calib. Data?"
11. Press "+".
  - ↳ Display reads "Calib. successful"
12. Press "+".

Back to measuring mode.

## 7.2 Device functions for calibration

Press the 'E' button during operation to call up the main menu. Use the '+' and '-' buttons to navigate through the available menus. When the desired menu is displayed, press the 'E' key to open the menu. Select the "x Back" option at the end of each menu/submenu to navigate one level higher in the menu structure.

Parameter		Configuration options	Description
DO			Calibration of dissolved oxygen measurement
	Slope air 100 %	Read only	Name of DO calibration method
	O2 (act) in %	Read only	Displays the current DO value as % saturation
	O2 cal air in %	Read only	Displays the DO value in air as %
	Save calib data?	Yes, No	Save or discard calibration data?
Temperature			Calibrate the temperature measurement.
	T cal. start	Read only	
	T cal.	Numerical value	
	Save calib data?	Yes, No	Save or discard calibration data?

## 8 Maintenance

No special maintenance work is required on the device.

## 9 Accessories

### 9.1 Sensors

#### Oxygen sensors

Oxymax COS51D

- Amperometric sensor for dissolved oxygen, with Memosens technology
- Order as per product structure, see Technical Information TI00413C/07/en

# 10 Troubleshooting

To help you troubleshoot, the following section is designed to provide an overview of possible causes of errors and initial remedial measures.

## 10.1 Troubleshooting instructions



**WARNING**

**Danger! Electric voltage!**

- ▶ Do not operate the device in an open condition for error diagnosis!

Display	Reason	Solution
No measured value displayed	No power supply connected	Check the power supply to the device.
	Power is supplied, device is defective	The device must be replaced.
Diagnostic message is displayed	The list of diagnostic messages is provided in the following section.	

## 10.2 Diagnostic messages

The diagnostics message comprises a diagnostics code and message text.

The diagnostics code is made up of the error category as per Namur NE 107 and the message number.

Error category (letter in front of the message number)

- **F = Failure.** A malfunction has been detected.  
The measured value of the specific channel is no longer reliable. The cause of the malfunction should be sought in the measuring point. If a controller is connected, this should be set to manual mode.
- **M = Maintenance required.** Action may have to be taken soon.  
The device stills measures correctly. Immediate measures must not be taken. However, proper maintenance efforts would prevent a possible malfunction in the future.
- **C = Function check.** (No error).  
Maintenance work is being performed on the device. Wait until the work has been completed.
- **S = Out of specification.** The measuring point is being operated outside specifications. Operation is still possible. However, you run the risk of increased wear, a shorter operating life or lower accuracy levels. The cause of the problem should be sought outside the measuring point.

Sample display:

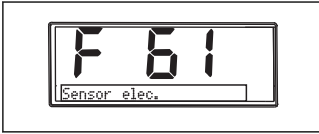

A0015896

F 61  
sensor elec.



A0015897

M 915  
USP warning

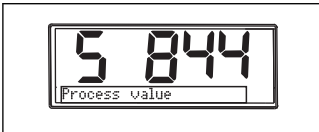

A0015898

S 844  
Process value

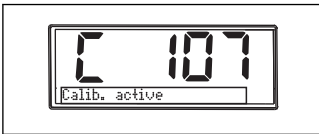

A0015899

C 107  
Calib. active

Error code	Message	Description
F5	Sensor data	Sensor data invalid. Remedy: <ul style="list-style-type: none"> <li>▪ Update date of the transmitter</li> <li>▪ Replace sensor</li> </ul>
F12	Writing data	The sensor data could not be written. Remedy: <ul style="list-style-type: none"> <li>▪ Repeat writing of the sensor data</li> <li>▪ Replace sensor</li> </ul>
F13	Sensor type	Incorrect sensor type. Remedy: Switch to a sensor of the configured type.
F61	Sensor elec.	Sensor electronics defective. Remedy: <ul style="list-style-type: none"> <li>▪ Replace sensor</li> <li>▪ Contact service</li> </ul>
F62	Sens. Connect	Sensor connection. Remedy: <ul style="list-style-type: none"> <li>▪ Replace sensor</li> <li>▪ Contact service</li> </ul>

Error code	Message	Description
F100	Sensor comm.	<p>No sensor communication.</p> <p>Possible reasons:</p> <ul style="list-style-type: none"> <li>▪ No sensor connection</li> <li>▪ Faulty sensor connection</li> <li>▪ Short-circuit in the sensor cable</li> <li>▪ Short-circuit in the neighboring channel</li> <li>▪ Sensor firmware update canceled with an error</li> </ul> <p>Remedy:</p> <ul style="list-style-type: none"> <li>▪ Check sensor cable connection</li> <li>▪ Check sensor cable for short-circuit</li> <li>▪ Replace sensor</li> <li>▪ Restart firmware update</li> <li>▪ Contact service</li> </ul>
F130	Sensor supply	<p>Sensor check.</p> <p>Poor energy supply to sensor.</p> <p>Remedy:</p> <ul style="list-style-type: none"> <li>▪ Check cable connections</li> <li>▪ Replace sensor</li> </ul>
F143	Self test	<p>Sensor self-test error.</p> <p>Remedy:</p> <ul style="list-style-type: none"> <li>▪ Replace sensor</li> <li>▪ Contact service</li> </ul>
F845	Device id	Faulty hardware configuration
F846	Param error	<p>Faulty parameter checksum</p> <p>Possible cause:</p> <p>Firmware update</p> <p>Remedy:</p> <p>Reset parameters to factory defaults</p>
F847	Couldn't save param	Parameters could not be saved
F848	Calib AO1	Faulty calibration values for analog output 1
F849	Calib AO2	Faulty calibration values for analog output 2
F904	Process check	<p>Process check system alarm.</p> <p>No change in measurement signal for a long time.</p> <p>Possible reasons</p> <ul style="list-style-type: none"> <li>▪ Sensor dirty or in air</li> <li>▪ No sensor inflow</li> <li>▪ Sensor defective</li> <li>▪ Software error</li> </ul> <p>Remedy:</p> <ul style="list-style-type: none"> <li>▪ Check measuring chain</li> <li>▪ Inspect sensor</li> <li>▪ Carry out software restart</li> </ul>

Error code	Message	Description
C107	Calib. active	Sensor calibration is active. Remedy: Wait for calibration
C154	No calib. data	Sensor data. No calibration data present, factory settings will be used. Remedy: <ul style="list-style-type: none"> <li>▪ Check calibration information of the sensor</li> <li>▪ Calibrate cell constant</li> </ul>
C850	Simu AO1	Simulation of analog output 1 is active
C851	Simu AO2	Simulation of analog output 2 is active
C852	Simu DO	Simulation of status output is active
C853	Download act.	Parameter transmission is active

Error code	Message	Description
S844	Process value	Measured value outside the specified range. Measured value outside the specified range. Possible reasons: <ul style="list-style-type: none"> <li>▪ Sensor in air</li> <li>▪ Air cushion in the assembly</li> <li>▪ Incorrect sensor inflow</li> <li>▪ Sensor defective</li> </ul> Remedy: <ul style="list-style-type: none"> <li>▪ Increase process value</li> <li>▪ Check measuring chain</li> <li>▪ Change sensor type</li> </ul>
S910	Limit switch	Limit switch energized

Error code	Message	Description
M126	Sensor check	Sensor check. Bad electrode status. Possible reasons: <ul style="list-style-type: none"> <li>▪ Glass membrane blocked or dry</li> <li>▪ Junction blocked</li> </ul> Remedy: <ul style="list-style-type: none"> <li>▪ Clean sensor and regenerate</li> <li>▪ Replace sensor</li> </ul>

## 10.3 Firmware history

### Revision history

The firmware version (FW) on the nameplate and in the Operating Instructions indicates the device release: XX.YY.ZZ (example 01.02.01).

- XX Change to main version. No longer compatible. The device and Operating Instructions change.
- YY Change to functions and operation. Compatible. The Operating Instructions change.
- ZZ Fixes and internal changes. No changes to the Operating Instructions.

Date	Firmware Version	Changes	Documentation
09/2011	01.01.ZZ	Original firmware	BA01033C/09/en/01.11
06/2014	02.00.ZZ	Limit values for sensors changed	BA01033C/09/en/02.14
12/2019	02.01.ZZ	Password protection for users amended	BA01033C/09/en/03.19

## 10.4 Spare parts

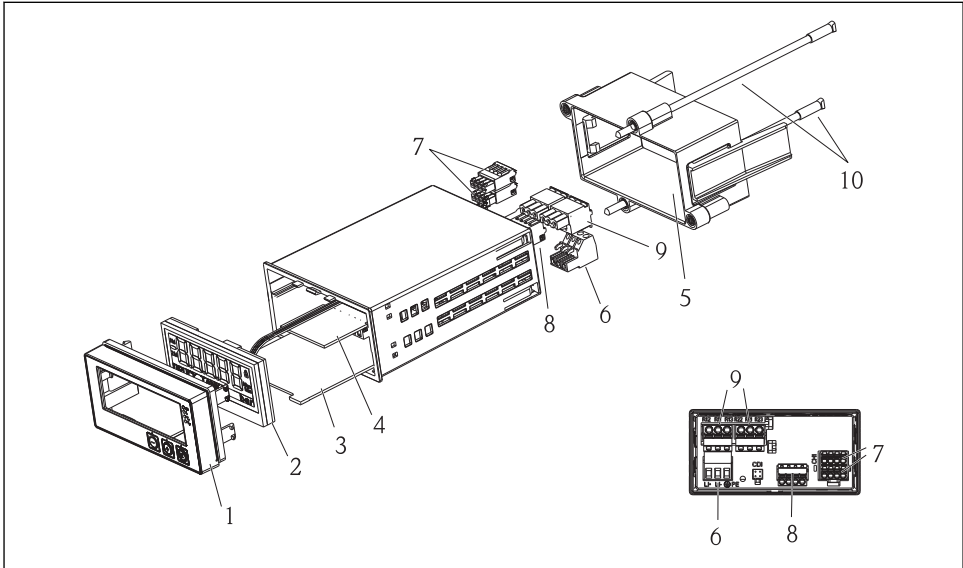

A0015745

5 Spare parts of the device



Item no.	Description	Order no.
1	Housing front + foil, incl. keyboard CM14, without display	XPM0004-DA
2	CPU/Display board CM14 DO amperometric	XPM0004-CO
3	Mainboard 24-230VDC/AC, CM14	XPM0004-NA
4	Relay board + 2 limit relays	RIA45X-RA
5	Fixing frame for housing W07	71069917
6	Terminal, 3-pole (power supply)	50078843
7	Pluggable terminal, 4-pole (Memosens input)	71037350
8	Pluggable terminal, 4-pole (current output)	71075062
9	Pluggable terminal, 3-pole (relay terminal)	71037408
10	Threaded bar for tube fixing clip 105mm	71081257

## 10.5 Return

For a return, e.g. in case of repair, the device must be sent in protective packaging. The original packaging offers the best protection. Repairs must only be carried out by your supplier's service organization.



When sending a device in for repair, please enclose a note with a description of the error and the application.

## 10.6 Disposal

The device contains electronic components and must, therefore, be disposed of as electronic waste in the event of disposal. Please pay particular attention to the local regulations governing waste disposal in your country.

# 11 Technical data

## 11.1 Input

### 11.1.1 Measured variables

--> Documentation of the connected sensor

### 11.1.2 Measuring ranges

--> Documentation of the connected sensor

### 11.1.3 Input types

Digital sensor inputs, Memosens and Memosens protocol

### 11.1.4 Cable specification

#### Cable type

Memosens data cable or fixed sensor cable, each with cable end sleeves

#### Cable length

Max. 100 m (330 ft)

## 11.2 Output

### 11.2.1 Output signal

2 x 0/4 to 20 mA active, potentially isolated from the sensor circuits and from each other

### 11.2.2 Load

Max. 500  $\Omega$

### 11.2.3 Linearization/transmission behavior

Linear

### 11.2.4 Alarm output

The alarm output is designed as an "open collector." In normal operation the alarm output is closed. In the event of a fault (F-fault, device without current) the "open collector" opens.

Current max. 200 mA

Voltage max. 30 V DC

## 11.3 Current outputs, active

### 11.3.1 Span

0 to 23 mA

### 11.3.2 Signal characterization

Linear

### 11.3.3 Electrical specification

#### Output voltage

Max. 24 V

### 11.3.4 Cable specification

#### Cable type

Recommendation: shielded line

#### Cross-section

Max. 1.5 mm<sup>2</sup> (16 AWG)

## 11.4 Relay outputs

### 11.4.1 Relay types

2 changeover contacts

### 11.4.2 Relay switching capacity

Max. 3 A 24 V DC

Max. 3 A 253 V AC

Min. 100 mW (5 V / 10 mA)

### 11.4.3 Cable specification

#### Cross-section

Max. 2.5 mm<sup>2</sup> (14 AWG)

## 11.5 Wiring

### 11.5.1 Electrical connection

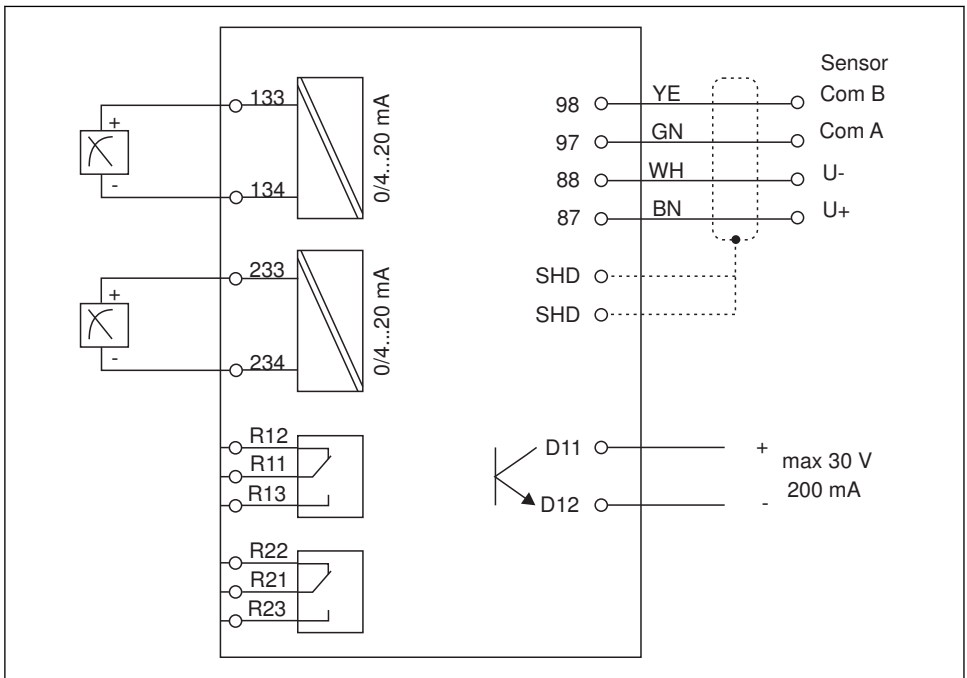

A0015303

Connection	Description
87	Terminal for Memosens cable, brown, sensor power supply U+
88	Terminal for Memosens cable, white, sensor power supply U-
97	Terminal for Memosens cable, green, Com A
98	Terminal for Memosens cable, yellow, Com B
SHD	Terminal for Memosens cable, shield
D11	Terminal for alarm output, +
D12	Terminal for alarm output, -
L/+	Terminal for transmitter supply voltage
N/-	
⊕ PE	
133	Terminal for analog output 1, +
134	Terminal for analog output 1, -
233	Terminal for analog output 2, +
234	Terminal for analog output 2, -
R11, R12, R13	Terminal for relay 1
R21, R22, R23	Terminal for relay 2

### 11.5.2 Supply voltage

Wide range power unit 24 to 230 V AC/DC (-20 % / +10 %) 50/60Hz



The device does not have a power switch

- The customer must provide a protected circuit breaker in the vicinity of the device.
- The circuit breaker must be a switch or power switch, and must be labeled as the circuit breaker for the device.

### 11.5.3 Power consumption

Max. 13.8 VA / 6.6 W

## 11.6 Performance characteristics

### 11.6.1 Response time

Current outputs

$t_{90}$  = max. 500 ms for a jump from 0 to 20 mA

### 11.6.2 Reference temperature

25 °C (77 °F)

### 11.6.3 Maximum measured error of inputs

--> Documentation of the connected sensor

### 11.6.4 Resolution of current output

> 13 bit

### 11.6.5 Repeatability

--> Documentation of the connected sensor

## 11.7 Mounting conditions

### 11.7.1 Installation instructions

#### Mounting location

Panel, cutout 92 x 45 mm (3.62 x 1.77 in)

Max. panel thickness 26 mm (1 in)

#### Installation position

The orientation is determined by the legibility of the display.

Max. viewing angle range of +/- 45° from the central display axis in every direction.

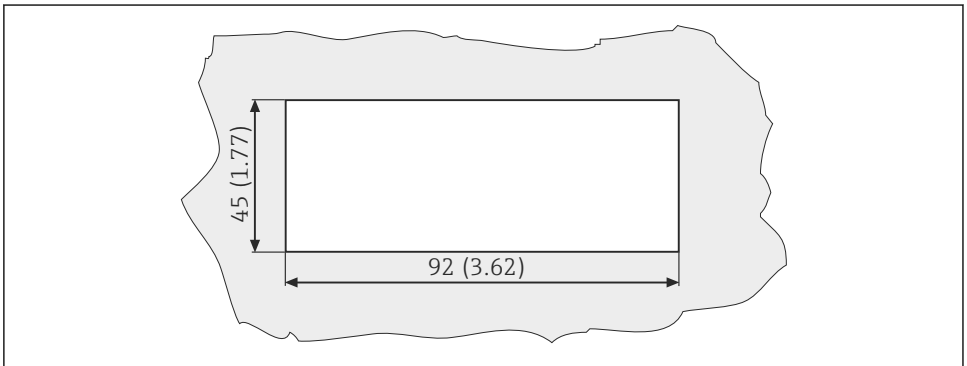

A0010351

6 Panel cutout, dimensions in mm (in)

## 11.8 Environment

### 11.8.1 Ambient temperature range

-10 to +60 °C (14 to 140 °F)

### 11.8.2 Storage temperature

-40 to +85 °C (-40 to +185 °F)

### 11.8.3 Operating height

< 2 000 m (6 561 ft) above MSL

### 11.8.4 Electromagnetic compatibility

Emitted interference and interference immunity to EN 61326-1:2006, Class A for industrial areas

### 11.8.5 Degree of protection

#### Front

Front IP65 / NEMA 4X

#### Tube

Shock protection IP20

### 11.8.6 Relative humidity

5 to 85 %, non-condensing

## 11.9 Mechanical construction

### 11.9.1 Dimensions

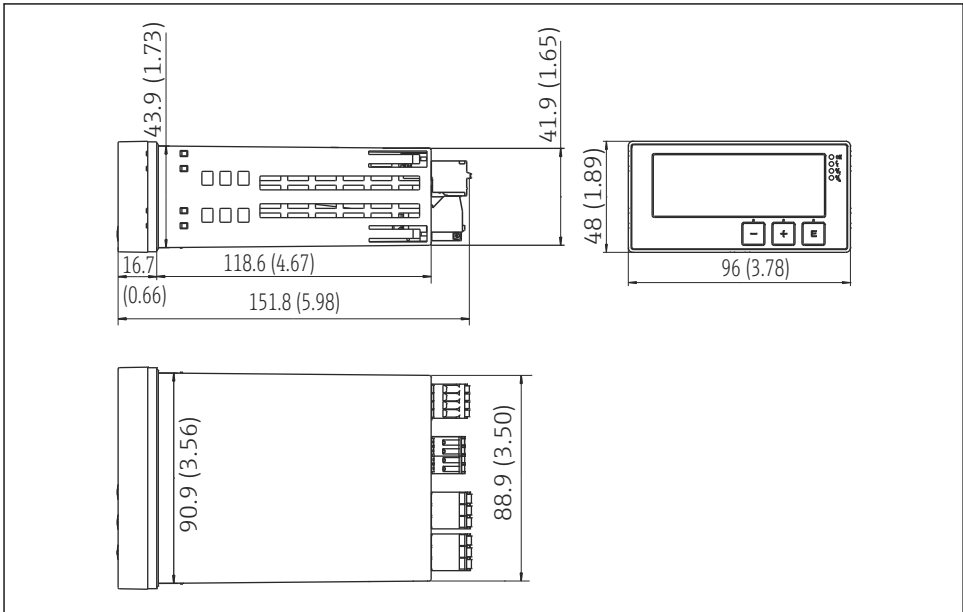

A0015925

7 Dimensions of the transmitter in mm (in)

## 11.9.2 Weight

0.3 kg (0.66 lbs)

## 11.9.3 Materials

Housing, casing: Polycarbonate  
 Front foil: Polyester, UV-resistant

## 11.9.4 Terminals

Max. 2.5 mm<sup>2</sup> (22-14 AWG; tightening torque 0.4 Nm (3.5 lb in)) line, relay

## 11.10 Display and operating elements

### 11.10.1 Operating elements

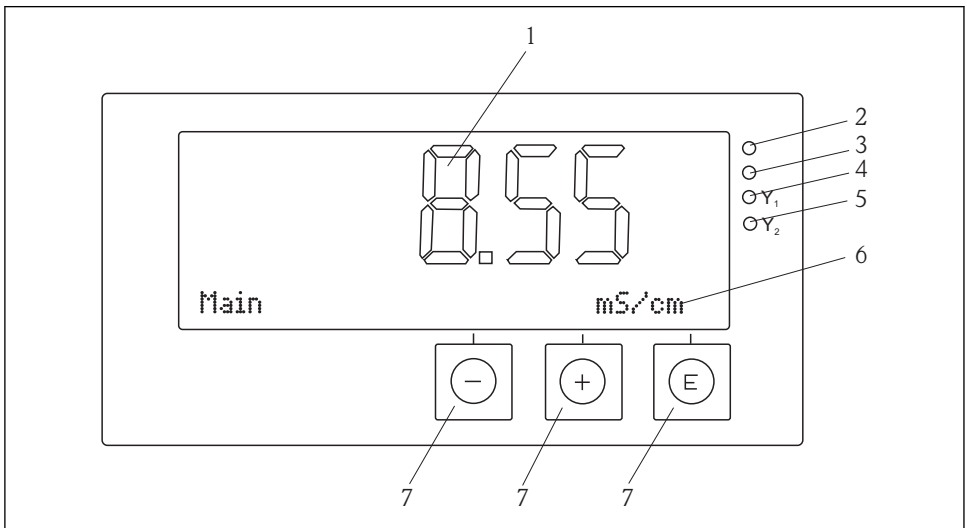

A0018699

#### 8 Display and operating elements

- 1 LC display for displaying the measured values and configuration data
- 2 Status LED, power supply connected
- 3 Status LED, alarm function
- 4 Status LED for limit switch relay 1
- 5 Status LED for limit switch relay 2
- 6 Dot matrix display for displaying the dimensions and menu items
- 7 Operating keys

## 11.11 Certificates and approvals

### 11.11.1 CE mark

#### Declaration of Conformity

The product fulfills the requirements of harmonized European standards.

Thus it fulfills the legal requirements of the EC Directives.

The manufacturer confirms successful testing of the device by affixing to it the CE mark.

#### Other standards and guidelines

- IEC 60529:  
Degree of protection by housing (IP code)
- IEC 61010-1: 2001 Cor 2003  
Safety requirements for electrical equipment for measurement, control and laboratory use



# Index

## C

CE mark . . . . . 8

## D

Device configuration

    Setup access protection . . . . . 17

Diagnostic messages . . . . . 28

Display symbols . . . . . 15

## E

Error messages . . . . . 28

## I

Icons

    Display . . . . . 15

    Editing mode . . . . . 15

## O

Operational safety . . . . . 4

## R

Relay . . . . . 22

## S

Staff

    Requirements . . . . . 4

## W

Workplace safety . . . . . 4





[www.addresses.endress.com](http://www.addresses.endress.com)

---