

Operating Instructions

CM14

Transmitter, conductivity

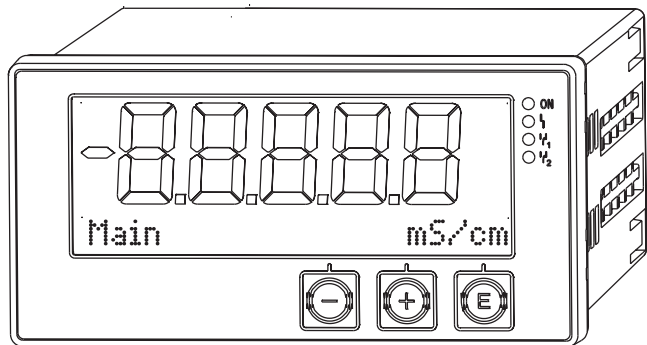

Table of contents

1	Safety instructions	4	7	Calibration (Calibration menu)	28
1.1	Workplace safety	4	7.1	General	28
1.2	Requirements concerning the staff	4	7.2	Device functions for calibration	28
1.3	Operational safety	4			
1.4	Designated use	5	8	Maintenance	29
1.5	Technical improvement	5	9	Accessories	30
1.6	Return	5	9.1	Sensors	30
1.7	Notes on safety conventions and icons	5	10	Troubleshooting	31
2	Identification	7	10.1	Troubleshooting instructions	31
2.1	Device name	7	10.2	Diagnostic messages	31
2.2	Scope of delivery	7	10.3	Firmware history	36
2.3	Certificates and approvals	8	10.4	Spare parts	36
3	Installation	9	10.5	Return	37
3.1	Incoming acceptance, transport, storage	9	10.6	Disposal	37
3.2	Installation	9	11	Technical data	37
3.3	Dimensions	9	11.1	Input	37
3.4	Installation procedure	10	11.2	Output	38
3.5	Post-installation check	10	11.3	Current outputs, active	38
4	Wiring	11	11.4	Relay outputs	39
4.1	Connecting the transmitter	12	11.5	Wiring	39
4.2	Post-connection check	13	11.6	Performance characteristics	40
5	Operation	14	11.7	Mounting conditions	41
5.1	Display and device status indicator / LED	14	11.8	Environment	41
5.2	Local operation at the device	14	11.9	Mechanical construction	42
5.3	Icons	15	11.10	Display and operating elements	43
5.4	Operating functions	16	11.11	Certificates and approvals	44
5.5	Hold function	16	Index	45	
6	Commissioning	17			
6.1	Post-installation check and switching on the device	17			
6.2	Display settings (Display menu)	17			
6.3	Notes on setup access protection	17			
6.4	Configuration of the device (Setup menu)	18			
6.5	Extended configuration (Extended setup menu)	19			
6.6	Device diagnostics (Diagnostics menu)	26			

1 Safety instructions

Safe operation of the transmitter is only guaranteed if these Operating Instructions have been read and the safety instructions have been observed.

1.1 Workplace safety

For work on and with the device:

- ▶ Wear the required personal protective equipment according to federal/national regulations.

If working on and with the device with wet hands:

- ▶ Due to the increased risk of electric shock, gloves must be worn.

1.2 Requirements concerning the staff

The personnel for installation, commissioning, diagnostics and maintenance must fulfill the following requirements:

- ▶ Trained, qualified specialists: must have a relevant qualification for this specific function and task
- ▶ Are authorized by the plant owner/operator
- ▶ Are familiar with federal/national regulations
- ▶ Before beginning work, the specialist staff must have read and understood the instructions in the Operating Instructions and supplementary documentation as well as in the certificates (depending on the application)
- ▶ Following instructions and basic conditions

The operating personnel must fulfill the following requirements:

- ▶ Being instructed and authorized according to the requirements of the task by the facility's owner-operator
- ▶ Following the instructions in these Operating Instructions

1.3 Operational safety

Risk of injury.

- ▶ Operate the device in proper technical condition and fail-safe condition only.
- ▶ The operator is responsible for interference-free operation of the device.

Conversions to the device

Unauthorized modifications to the device are not permitted and can lead to unforeseeable dangers.

- ▶ If, despite this, modifications are required, consult with Endress+Hauser.

Repair

To ensure continued operational safety and reliability,

- ▶ Carry out repairs on the device only if they are expressly permitted.
- ▶ Observe federal/national regulations pertaining to repair of an electrical device.
- ▶ Use original spare parts and accessories from Endress+Hauser only.

1.4 Designated use

The transmitter evaluates measured values of an analytical sensor and visualizes them on its multicolored display. Processes can be monitored and controlled with the unit's outputs and limit relays. The device is equipped with a wide array of software functions for this purpose.

- The manufacturer does not accept liability for damage caused by improper or non-designated use. The device may not be converted or modified in any way.
- The device is designed for installation in a panel and must only be operated in an installed state.

1.5 Technical improvement

The manufacturer reserves the right to adapt technical details to the most up-to-date technical developments without any special announcement. Please contact your sales center for information on modifications or updates to the Operating Instructions.

1.6 Return

For a return, e.g. in case of repair, the device must be sent in protective packaging. The original packaging offers the best protection. Repairs must only be carried out by your supplier's service organization.



When returning the device for repair, enclose a note with a description of the problem and the application.

1.7 Notes on safety conventions and icons

1.7.1 Warnings



Causes (/consequences)

Consequences of non-compliance (if applicable)

- ▶ Corrective action
- ▶ This symbol alerts you to a dangerous situation. Failure to avoid the situation will result in a fatal or serious injury.



Causes (/consequences)

Consequences of non-compliance (if applicable)

- ▶ Corrective action
- ▶ This symbol alerts you to a dangerous situation. Failure to avoid the situation can result in a fatal or serious injury.



Causes (/consequences)

Consequences of non-compliance (if applicable)







- ▶ Corrective action
- ▶ This symbol alerts you to a dangerous situation. Failure to avoid this situation can result in minor or more serious injuries.

NOTICE**Causes (/consequences)**

Consequences of non-compliance (if applicable)

- ▶ Corrective action
- ▶ This symbol alerts you to situations which may result in damage to property.

1.7.2 Document symbols

- | | |
|---|---|
|  | Allowed
Indicates procedures, processes or actions that are allowed. |
|  | Preferred
Indicates procedures, processes or actions that are preferred. |
|  | Forbidden
Indicates procedures, processes or actions that are forbidden. |
|  | Additional information, tips |
|  | Reference to documentation |
|  | Reference to a page in this manual |
|  | Reference to a graphic |

2 Identification

2.1 Device name

2.1.1 Nameplate

Compare the nameplate with the following diagram:

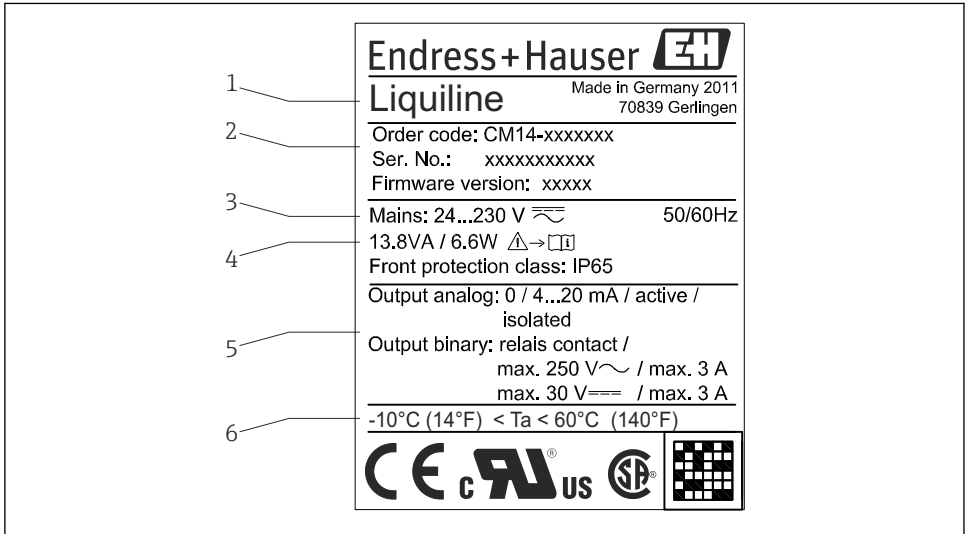

A0015221

1 Nameplate of the transmitter (example)

- 1 Device name
- 2 Device order code, serial number and ID number
- 3 Power supply
- 4 Power consumption
- 5 Output values
- 6 Temperature range

2.2 Scope of delivery

The scope of delivery of the transmitter comprises:

- Transmitter for panel mounting
- Operating Instructions
- Fastening fixtures

2.3 Certificates and approvals

2.3.1 CE mark

The product meets the requirements of the harmonized European standards. As such, it complies with the legal specifications of the EC directives. The manufacturer confirms successful testing of the product by affixing to it the CE-mark.

2.3.2 EAC mark

The product meets the legal requirements of the EEU guidelines. The manufacturer confirms the successful testing of the product by affixing the EAC mark.

3 Installation

3.1 Incoming acceptance, transport, storage

The permitted ambient and storage conditions must be observed. The precise specifications can be found in Section "Technical data" →  37.

3.1.1 Incoming acceptance

On receipt of the goods, check the following points:

- Are the packaging or contents damaged?
- Is anything missing from the delivery? Compare the scope of delivery with the information you specified in the order.

3.1.2 Transportation and storage

Note the following points:

- Pack the device so that is protected against impact for storage and transportation. The original packaging provides optimum protection.
- The permitted storage temperature range is -40 to $+85$ °C (-40 to $+185$ °F); it is possible to store the device in the borderline temperature ranges for a limited period (maximum 48 hours).

3.2 Installation

NOTICE

Overheating due to heat accumulation in the device

- ▶ To avoid heat accumulation, please always make sure the device is sufficiently cooled.



If the device is operated in the upper temperature limit range, this reduces the operating life of the display.

The transmitter is designed to be used in a panel.

The orientation is determined by the readability of the display. Connections and outputs are fitted on the rear of the device. The wires are connected by means of number-coded terminals.

Ambient temperature range: -10 to $+60$ °C (14 to 140 °F)

3.3 Dimensions

Observe the installation depth of 150 mm (5.91 ") for the device incl. terminals and fastening clips.

More dimensions can be found in Section "Technical data" →  37.

- Panel cutout: 92 mm x 45 mm (3.62 in x 1.77 in).
- Panel thickness: max. 26 mm (1 in).
- Max. viewing angle range: 45° to the left and right from the central display axis.
- If the devices are arranged horizontally beside one another in the X-direction, or arranged vertically on top of one another in the Y-direction, the mechanical distance (specified by the housing and front section) must be observed.

3.4 Installation procedure

The required panel cutout is 92 mm x 45 mm (3.62 in x 1.77 in).

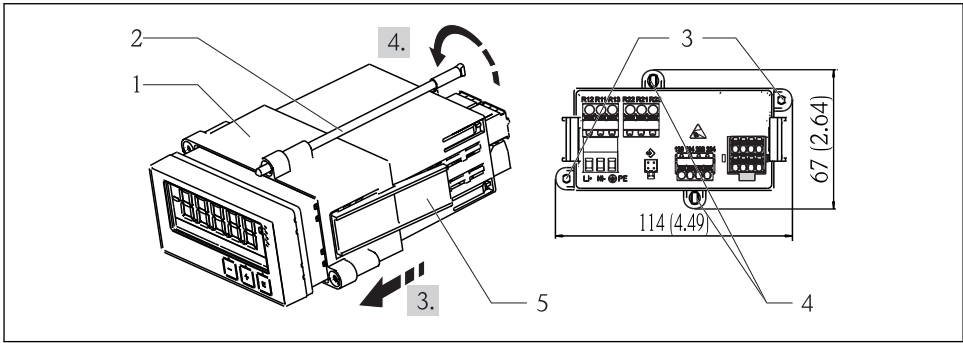

A0015216

2 Installation in the panel

1. Screw the threaded rods (item 2) into the positions provided on the mounting frame (item 1). Four opposing screw positions (item 3/4) are available for this purpose.
2. Push the device with the sealing ring through the panel cutout from the front.
3. To secure the tube in the panel, hold the device in a horizontal position and push the installation frame (item 1), with the threaded rods screwed in, over the tube until the frame locks into position.
4. Tighten the threaded rods to fasten the device in place.

To disassemble the device, the mounting frame can be unlocked at the locking elements (item 5) and then removed.

3.5 Post-installation check

- Is the sealing ring undamaged?
- Is the mounting frame securely engaged on the housing of the device?
- Are the threaded rods tightened?
- Is the device positioned in the center of the panel cutout?

4 Wiring

WARNING

Danger from electrical voltage

- ▶ The entire connection of the electrical system must take place while the device is de-energized.

Danger if protective ground is interrupted

- ▶ The protective ground connection must be established before any other connection is made.

NOTICE

Thermal load of the lines

- ▶ Use suitable lines for temperatures of 5 °C (9 °F) above ambient temperature.

Malfunction or destruction of the device due to incorrect supply voltage

- ▶ Prior to commissioning, make sure the supply voltage matches the specifications on the nameplate (bottom side of the housing).

Ensure the emergency shutoff of the device

- ▶ Provide a suitable switch or power-circuit breaker in the building installation. This switch must be provided within easy reach of the device and be labeled as a disconnecter.

Protect device from overload

- ▶ Provide a overload protection unit (rated current = 10 A) for the power supply line.

Incorrect wiring can cause destruction of the device

- ▶ Observe the terminal designation on the rear of the device.

Energy-rich transients in long signal lines

- ▶ Connect suitable upstream overvoltage protection in series.



It is permitted to connect a mixture of safety extra low voltage and voltage which poses a shock hazard to the relays.

4.1 Connecting the transmitter

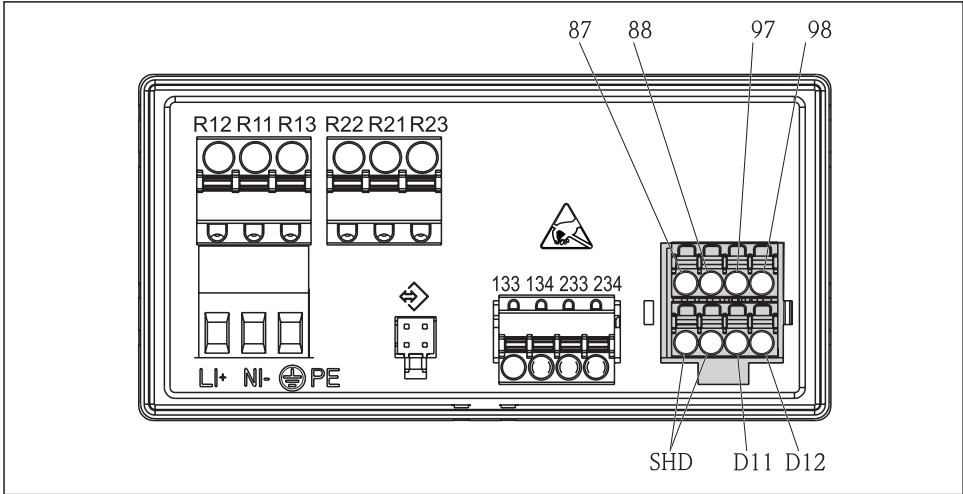



A0015215

3 Connection diagram of the transmitter

Terminal	Description
87	Terminal for Memosens cable, brown, sensor power supply U+
88	Terminal for Memosens cable, white, sensor power supply U-
97	Terminal for Memosens cable, green, Com A
98	Terminal for Memosens cable, yellow, Com B
SHD	Terminal for Memosens cable, shield
D11	Terminal for alarm output, +
D12	Terminal for alarm output, -
L/+	Terminal for transmitter supply voltage
N/-	
⊕ PE	
133	Terminal for analog output 1, +
134	Terminal for analog output 1, -
233	Terminal for analog output 2, +
234	Terminal for analog output 2, -
R11, R12, R13	Terminal for relay 1
R21, R22, R23	Terminal for relay 2

4.2 Post-connection check

Device condition and specifications	Notes
Are the device or cables damaged?	Visual inspection
Electrical connection	Notes
Does the supply voltage match the specifications on the nameplate?	24 to 230 V AC/DC (-20 % / +10 %) 50/60 Hz
Are all of the terminals firmly engaged in their correct slots? Is the coding on the individual terminals correct?	-
Are the mounted cables strain-relieved?	-
Are the supply voltage and signal cables connected correctly?	See connection diagram, →  3,  12 and on the housing.

5 Operation

The device's simple operating concept enables you to perform commissioning for many applications without the need for hardcopy operating instructions.

5.1 Display and device status indicator / LED

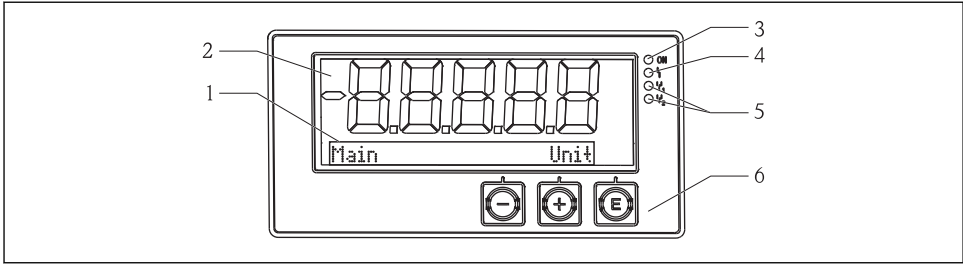

A0015891

4 Device display

- 1 Dot matrix section
- 2 7-segment display
- 3 LED status indicator, power supply connected
- 4 LED status indicator, alarm function
- 5 LED status indicator, limit switch relay 1/2
- 6 Operating keys

The device offers users a backlit LC display which is divided into two sections. The segment section displays the measured value.

In the dot matrix section, additional channel information, such as the TAG, unit or bar graph, is shown in the display mode. Operating text in English is displayed here during operation.

The parameters for configuring the display are explained in detail in the "Commissioning" section.

In the event of an error, the device automatically switches between displaying the error and displaying the channel, see the "Device diagnostics" → 26 and "Troubleshooting" → 31 sections.

5.2 Local operation at the device

The device is operated using the three keys integrated in the front of the device





- Open the Configuration menu
- Confirm an entry
- Select a parameter or submenu offered in the menu

Within the Configuration menu:

- Gradually scroll through the parameters / menu items / characters offered
- Change the value of the selected parameter (increase or decrease)



Outside the Configuration menu:



Display enabled and calculated channels, as well as minimum and maximum values, for all the active channels.

You can always exit menu items / submenus by selecting "x Back" at the end of the menu.

Leave the setup directly without saving the changes by pressing the '-' and '+' keys simultaneously for longer (> 3 s).

5.3 Icons

5.3.1 Display symbols

	Hold function →  16 active.
Max	Maximum value/value of the maximum indicator of the channel displayed
Min	Minimum value/value of the minimum indicator of the channel displayed
-----	Error, under/over range. No measured value is displayed.
	The device is locked / operator lock; the device setup is locked for changes to parameters; the display can be changed.



The error and the channel identifier (TAG) are specified in the dot matrix section.





5.3.2 Icons in the editing mode

The following characters can be used to enter user-defined text:

'0-9', 'a-z', 'A-Z', '+', '-', '*', '/', '\', '%', '°', '2', '3', 'm', '.', ',', ';', ':', '!', '?', '_', '#', '\$', '"', "'", '(', ')', '~',

For numerical entries, the numbers '0-9' and the decimal point are available.

Furthermore, the following icons are used in the editing mode:

	Symbol for setup
	Symbol for expert setup
	Symbol for diagnostics
	Accept entry. If this symbol is selected, the entry is applied at the position specified by the user, and you quit editing mode.

✘	Reject entry. If this symbol is selected, the entry is rejected and you quit editing mode. The previously set text remains.
+	Jump one position to the left. If this symbol is selected, the cursor jumps one position to the left.
⬅	Delete backwards. If this symbol is selected, the character to the left of the cursor position is deleted.
☒	Delete all. if this symbol is selected, the entire entry is deleted.

5.4 Operating functions

The operating functions of the transmitter are organized into the following menus:

Display	Settings for the device display: contrast, brightness, time for alternating measured values on the display
Setup	Device settings A description of the individual settings is provided in the "Commissioning" section → 17.
Calibration	Execution of the sensor calibration A description of the functions for calibration is provided in the "Calibration" section.
Diagnostics	Device information, diagnostics logbook, sensor information, simulation

5.5 Hold function

The hold function causes the current outputs and relay states to "freeze". This function can be switched on and off manually (menu **Setup** → **Manual hold**). In addition, the hold function is automatically activated during sensor calibration.

When the hold condition no longer applies, the hold function continues to be active for the configurable hold release time. The hold release time is configured in the menu **Setup** → **Extended setup** → **System** → **Hold release**.

The hold function does not affect the display of the measured value. The hold symbol is also displayed after the measured value.

6 Commissioning

6.1 Post-installation check and switching on the device

Make sure that all post-connection checks have been carried out before you commission your device:

- Checklist for "post-installation check", →  10.
- Checklist for "post-connection check" →  13.

After the operating voltage is applied, the green LED lights up and the display indicates the device is ready for operation.

If you are commissioning the device for the first time, program the setup as described in the following sections of the Operating Instructions.

When commissioning a device already configured or preset, measuring is immediately started as per the settings. The values of the channels currently activated are shown on the display.



Remove the protective film from the display as this would otherwise affect the readability of the display.

6.2 Display settings (Display menu)

You can access the main menu by pressing the 'E' key during operation. The Display menu appears on the display. Press the 'E' key again to open this menu. Use the "x Back" option, which can be found at the bottom of each menu/submenu, to move up one level in the menu structure.

Parameters	Possible settings	Description
Contrast	1-7 Default: 5	Setting for the display contrast.
Brightness	1-7 Default: 5	Setting for the brightness of the display.
Alternating time	0, 3, 5, 10 sec	Switching time between the two measured values. 0 means that the values do not alternate on the display.

6.3 Notes on setup access protection





Access to the setup is enabled by default (factory setting) and can be locked via the setup settings.

Proceed as follows to lock the device:

1. Press **E** to enter the configuration menu.
2. Press **+** repeatedly until **Setup** is displayed.
3. Press **E** to open the **Setup** menu.
4. Press **+** repeatedly until **Extended Setup** is displayed.

5. Press **E** to open the **Extended Setup** menu; **System** is displayed.
6. Press **E** to open the **System** menu.
7. Press **+** repeatedly until **Access code** is displayed.
8. Press **E** to open the setting for access protection.
9. Set the code: press the **+** and **-** buttons to set the desired code. The access code is a four-digit number. The corresponding position of the number is displayed in plain text. Press **E** to confirm the value entered and go to the next position.
10. Confirm the last position of the code to exit the menu. The full code is displayed. Press **+** to scroll back to the last item of the **x Back** submenu and confirm this item. By confirming the point, the value is adopted and the display returns to the **Setup** level. Again select the last parameter **x Back** to also exit this submenu and return to the measured value/channel display level.

Once access protection has been successfully activated, the lock symbol appears on the display.

-  Access to the calibration function can also be blocked by a code. The same procedure is required here as for locking the setup. To activate it, however, press **+** repeatedly in step 7 until **Calib Code** is displayed.
-  The **x Back** item at the end of every picklist/menu item takes the user from the submenu to the next menu level up.
-  If access protection is enabled, the device locks automatically after 600 seconds without operation. The display switches back to the operating display.
-  To enable the setup, set the setup access code in the **System** Setup to **0000** or delete the code by pressing **C**.
-  If you lose/misplace the code, a reset can only be performed by the Service Department.

6.4 Configuration of the device (Setup menu)

You can access the main menu by pressing the 'E' key during operation. Navigate through the available menus with the '+' and '-' keys. When the desired menu is displayed, press the 'E' key to open the menu. Use the "x Back" option, which can be found at the bottom of each menu/submenu, to move up one level in the menu structure.

The Setup menu contains the most important settings for the operation of the device.



Parameters	Possible settings	Description
Tag	Customized text Max. 16 characters	Use this function to enter the device tag.
Current range	4-20 mA 0-20 mA	Configuration of the measuring range for the current output.



Parameters	Possible settings	Description
Out 1 0/4 mA	Numerical value 0.000 to 99 999 0.0 mS/cm	Physical value which corresponds to the lower range limit of the analog output. When the configured value is undershot, the current output is set to the saturation current of 0/3.8 mA.
Out 1 20 mA	Numerical value 0.000 to 99 999 0.2 mS/cm (conductive) 200 mS/cm (inductive)	Physical value which corresponds to the upper range limit of the analog output. When the configured value is exceeded, the current output is set to the saturation current of /20.5 mA.
Out 2 0/4 mA	Numerical value -50 to 250 °C 0.0 °C	Temperature which corresponds to the measuring range lower limit of the temperature input. When the configured value is undershot, the current output is set to the saturation current of 0/3.8 mA.
Out 2 20 mA	Numerical value -50 to 250 °C 100 °C	Temperature which corresponds to the measuring range upper limit of the temperature input. When the configured value is exceeded, the current output is set to the saturation current of /20.5 mA.
Damping main value	0 to 60 s 0 s	Configuration of the damping for low-pass filtering of the input signals.
Extended setup		Advanced settings for the device, such as the relay, limit values etc. The functions are described in the following section, →  19.
Manual hold	Off, On	Function for freezing the current and relay outputs

6.5 Extended configuration (Extended setup menu)

You can access the main menu by pressing the 'E' key during operation. Navigate through the available menus with the '+' and '-' keys. When the desired menu is displayed, press the 'E' key to open the menu. Use the 'x Back' option, which can be found at the bottom of each menu/submenu, to move up one level in the menu structure.

Parameters	Possible settings	Description
System		General settings
Tag	Customized text, max. 16 characters Default: Aa	Use this function to enter the device tag.
Temp. unit	°C °F	Setting for the temperature unit

Parameters		Possible settings	Description
	Hold release	0 to 600 s 0 s	Sets the time by which a device hold is extended after the hold condition is discontinued.
	Alarm delay	0 to 600 s 0 s	Delay time for outputting an alarm. This suppresses alarm conditions that are present for a period that is shorter than the alarm delay time.
	Access code	0000 to 9999 Default: 0000	User code to protect the device configuration. Additional information: 0000 = user code protection is disabled
	Calib Code	0000 to 9999 Default: 0000	User code to protect the calibration function. Additional information: 0000 = user code protection is disabled
Input			Input settings
	Operating mode	conductivity resistivity TDS	Configuration of the operating mode
	Cell constant	Read only (Only available if a sensor is connected)	Displays the cell constant of the connected sensor (see sensor certificate).
	Install factor	0.1 to 5.0 1.0	Installation factor for inductive sensors to correct the conductivity measurement. Configuration by entering the factor. For additional information on the installation factor, →  22.
	Unit	auto , µS/cm, mS/cm	Unit of the physical value. "auto" toggles automatically between µS/cm and mS/cm.
	Format	None , one, two	Number of places after decimal point for the display.
	Damping main value	0 to 60 s 0 s	Configuration of the damping for low-pass filtering of the input signals.
	Temp. comp.	off, Linear , UPW HCl, UPW NaCl, NaCl (IEC 746-3), Water ISO 7888	Configuration of the temperature compensation. Various methods are available to compensate for the temperature dependency. This depends on the processes in which the measurement is used. For additional information on temperature compensation, →  23.
	T. comp. cal.	off , Linear	Configuration of the temperature compensation for cell constant calibration.
	Alpha coeff.	1.0 to 20.0 %/K 2.1 %/K	Coefficient for linear temperature compensation.

Parameters		Possible settings	Description
	Ref. temp.	25 °C	Reference temperature for calculating the linear temperature-compensated conductivity. For more information on alpha coefficients and the alpha reference temperature, refer to the "Temperature compensation" section, →  23.
	Process check		Checks the process settings
	Function	On, Off	Switch on the process check.
	Inactive time	1 to 240 min 60 min	Duration of the process check
	Band width	1 to 20 % 1 %	Bandwidth for the process check
Analog outputs			Settings for analog outputs
	Current range	4-20 mA 0-20 mA	Current range for analog output
	Out 1 0/4 mA	Numerical value 0.000 - 99999 0.1 mS/cm	Physical value which corresponds to the lower range limit of the analog output.
	Out 1 20 mA	Numerical value 0.000 - 99999 200 mS/cm	Physical value which corresponds to the upper range limit of the analog output.
	Out 2 0/4 mA	Numerical value -50 to 250 °C 0 °C	Temperature which corresponds to the measuring range lower limit of the temperature input.
	Out 2 20 mA	Numerical value -50 to 250 °C 100 °C	Temperature which corresponds to the measuring range upper limit of the temperature input.
	Damping main value	0 to 60 s 0 s	Configuration of the damping for low-pass filtering of the input signals.
Relay 1/2			Settings for the relay outputs. For additional information on the configuration of the relays, →  25.
	Function	Off , USP alarm, EP alarm, USP pre-alarm, EP pre-alarm, Min limit, Max limit, In band, Out band, Error	Configuration of the relay function.
	Assignment	Main , Temp	Assignment of the relay to the main input or temperature input
	Set point	Numerical value 0.0	Cannot be configured for the Error function (error signaling relay).
	Set point 2	Numerical value 0.0	Only for the In band or Out band function

Parameters		Possible settings	Description
	Hyst.	Numerical value 0.0	Configuration of the hysteresis. Not for the Error function.
	Delay time	0 to 60 s 0 s	Configuration of the delay time until the relay switches. Not for the Error function.
Factory default			Resets the device settings to the factory default settings.
	Please confirm	no , yes	Confirm the reset.

6.5.1 Configuration of the relays

The device has two relays with limit values that are either switched off or can be allocated to the input signal. The limit value is entered as a numerical value including the decimal position. The operating mode of the relays as normally open or normally closed is determined by the wiring of the changeover contact (→  39). Limit values are always assigned to a relay. Each relay can be assigned to a channel or a calculated value. In the "Error" mode, the relay functions as an alarm relay and switches each time a fault or alarm occurs.

The following settings can be made for each of the 2 limit values: assignment, limit, hysteresis, switching behavior, delay and failure mode.

6.5.2 Installation factor (inductive sensors only)

In confined installation conditions, the conductivity measurement is affected by the pipe walls. The installation factor compensates for this effect. The transmitter corrects the cell constant by multiplying by the installation factor.

The value of the installation factor depends on the diameter and the conductivity of the pipe nozzle as well as the sensor's distance to the wall.

If the wall distance is sufficient ($a > 15 \text{ mm}$ (0.59 in), DN 80 or higher), the installation factor f does not have to be taken into account ($f = 1.00$).

For small distances to the wall, the installation factor increases for electrically insulating pipes ($f > 1$) and decreases for electrically conductive pipes ($f < 1$).

It can be measured using calibration solutions, or determined by approximation from the following diagram.

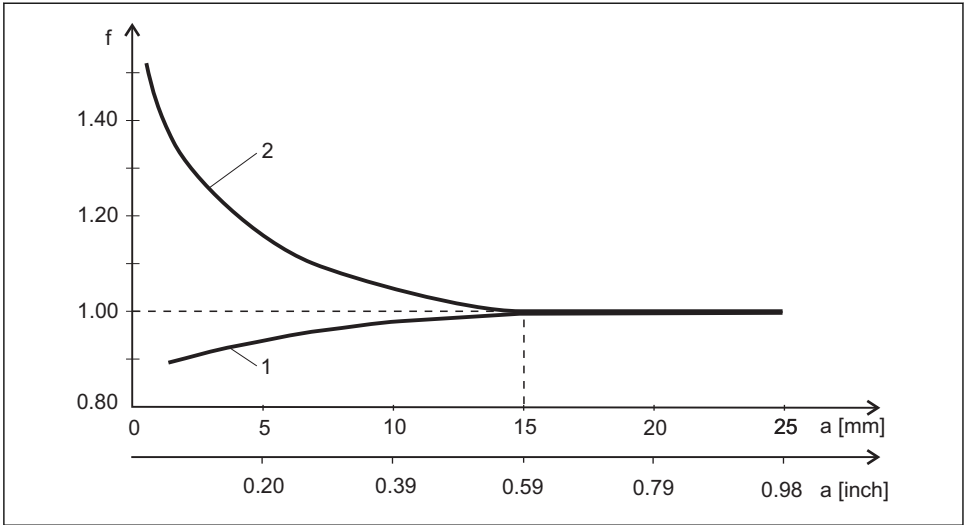

A0005441

5 Relationship between the installation factor (f) and the distance from wall (a)

- 1 Electrically conductive pipe wall
- 2 Electrically insulating pipe wall

6.5.3 Temperature compensation

The conductivity of a liquid depends heavily on the temperature, as the mobility of the ions and the number of dissociated molecules are temperature-dependent. In order to compare measured values, they must be referenced to a defined temperature. The reference temperature is 25 °C (77 °F).

When specifying the conductivity, it is always necessary to specify the temperature. $K(T_0)$ is the conductivity measured at 25 °C (77 °F) or recalculated to 25 °C (77 °F).

The temperature coefficient α represents the percentage change in the conductivity per degree of temperature change. The conductivity K at the process temperature is calculated as follows:

$$K(T) = K(T_0) (1 + \alpha(T - T_0))$$

$K(T)$ conductivity at process temperature T

$K(T_0)$ conductivity at reference temperature T_0

The temperature coefficient depends on both the chemical composition of the solution and on the temperature, and is between 1 % and 5 % per °C. The electrical conductivity of the majority of diluted saline solutions and natural waters changes in a close-to-linear fashion.

Typical values for the temperature coefficient Alpha:

Natural water	Approx. 2 %/K
Salts (e.g. NaCl)	Approx. 2.1 %/K

Alkali (e.g. NaOH)	Approx. 1.9 %/K
Acids (e.g. HNO ₃)	Approx. 1.3 %/K

NaCl compensation

NaCl compensation is activated using the setting **Extended setup** → **Input** → **Temp. comp.** = **NaCl (IEC 746-3)**.

In the case of NaCl compensation (as per IEC 60746), a fixed non-linear curve specifying the relationship between the temperature coefficient and temperature is saved in the device. This curve applies to low concentrations of up to approx. 5 % NaCl.

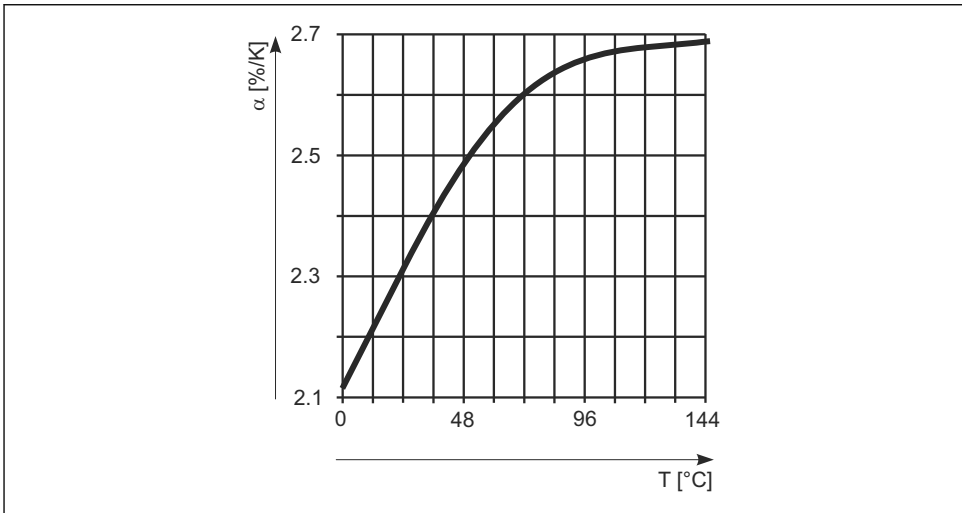

A0008939

Compensation for natural water

Compensation for natural water is activated using the setting **Extended setup** → **Input** → **Temp. comp.** = **Water ISO 7888**.

A non-linear function in accordance with ISO 7888 is saved in the device for temperature compensation in natural water.

Ultrapure water compensation (for conductive sensors)

Compensation for ultrapure water is activated using the setting **Extended setup** → **Input** → **Temp. comp.** = **UPW HCl** or **UPW NaCl**.

Algorithms for pure and ultrapure water are stored in the device. These algorithms take the dissociation of the water and its temperature dependency into account. They are used up to conductivity levels of approx. 100 $\mu\text{S}/\text{cm}$.

- UPW NaCl: optimized for pH-neutral impurities
- UPW HCl: optimized for measuring the acid conductivity downstream of a cation exchanger. Also suitable for ammonia (NH₃) and caustic soda (NaOH).

6.5.4 Configuration of the relays

The device has two relays with limit values that are either switched off or can be allocated to the input signal. The limit value is entered as a numerical value including the decimal position. Limit values are always assigned to a relay. Each relay can be assigned to a channel or a calculated value. In the "Error" mode, the relay functions as an alarm relay and switches each time a fault or alarm occurs.

The following settings can be made for each of the 2 limit values: assignment, operating mode, limit, hysteresis, switching behavior, delay and failure mode.

Limit values for pharmaceutical water according to United States Pharmacopoeia (USP) and European Pharmacopoeia (EP) (only for conductive sensors)

For conductive sensors, the transmitter has functions for monitoring "Water for Injection" (WFI), "Highly Purified Water" (HPW) and "Purified Water" (PW) according to the United States Pharmacopoeia (USP) Part 645 and European Pharmacopoeia (EP) standards.

USP function: The temperature-dependent limit values in the following table apply for "Water for Injection" (WFI) according to USP and EP and for "Highly Purified Water" (HPW) according to EP. The table is programmed into the transmitter.

Temperature [°C]	Conductivity [μ S/cm]	Temperature [°C]	Conductivity [μ S/cm]
0	0.6	55	2.1
5	0.8	60	2.2
10	0.9	65	2.4
15	1.0	70	2.7
20	1.1	75	2.7
25	1.3	80	2.7
30	1.4	85	2.7
35	1.5	90	2.7
40	1.7	95	2.9
45	1.8	100	3.1
50	1.9		

The measurement is performed in the following steps:

- The transmitter determines the uncompensated conductivity and the water temperature.
- The transmitter rounds the temperature down to the nearest 5 °C and compares the measured conductivity with the associated value in the table.
- If the measured value is greater than the value in the table, an alarm is triggered (E151).

EP-PW function: The following table lists the temperature-dependent limit values for "Purified Water" (PW) in accordance with EP; this table is also programmed into the transmitter.

Temperature [°C]	Conductivity [$\mu\text{S}/\text{cm}$]	Temperature [°C]	Conductivity [$\mu\text{S}/\text{cm}$]
0	2.4	60	8.1
10	3.6	70	9.1
20	4.3	75	9.7
25	5.1	80	9.7
30	5.4	90	9.7
40	6.5	100	10.2
50	7.1		

The measurement is performed in the following steps:

- The transmitter determines the uncompensated conductivity and the water temperature.
- If the temperature is between two table entries, the limit value for the conductivity is determined by interpolation of the two neighboring points.
- An alarm is triggered if the measured value is greater than the limit value.

Pre-alarm

In addition, a USP pre-alarm is available that is activated at an adjustable switch-on point of 80 % of the USP/EP limit value. This means that users are alerted in time to the need to regenerate their system.

6.6 Device diagnostics (Diagnostics menu)

You can access the main menu by pressing the 'E' key during operation. Navigate through the available menus with the '+' and '-' keys. When the desired menu is displayed, press the 'E' key to open the menu. Use the "x Back" option, which can be found at the bottom of each menu/submenu, to move up one level in the menu structure.

Parameters	Possible settings	Description	
Current diag.	Read only.	Displays the current diagnostic message	
Last diag.	Read only.	Displays the last diagnostic message	
Diagnost logbook	Read only	Displays the last diagnostic messages	
Device info	Read only.	Displays the device information	
	Device tag	Read only.	Displays the device tag
	Device name	Read only.	Displays the device name
	Serial number	Read only.	Displays the serial number of the device
	Order ident	Read only.	Displays the order code of the device
	FW revision	Read only.	Displays the firmware version

Parameters		Possible settings	Description
	ENP version	Read only.	Displays the version of the electronic nameplate
	Module ID	Read only.	Displays the module ID
	Manufact. ID	Read only.	Displays the manufacturer ID
	Manufact. name	Read only.	Displays the manufacturer name

7 Calibration (Calibration menu)

7.1 General

Determining the relationship between the measured or expected value of the output variable and the corresponding true or correct value of the measured variable (input variable) for a measuring device under specified conditions.

During calibration, there is no intervention that changes the measuring instrument.

7.2 Device functions for calibration

Press the 'E' button during operation to call up the main menu. Use the '+' and '-' buttons to navigate through the available menus. When the desired menu is displayed, press the 'E' key to open the menu. Select the "x Back" option at the end of each menu/submenu to navigate one level higher in the menu structure.

Parameter		Configuration options	Description
Conductivity			Calibrate the conductivity measurement.
	C calib. start	Read only	
	k	Read only	Current cell constant
	C cal.	Numerical value 0 mS/cm	
	k	Read only	Newly calculated cell constant
	Save calib data?	Yes, No	Save or discard calibration data?
Temperature			Calibrate the temperature measurement.
	T cal. start	Read only	
	T cal.	Numerical value	
	Save calib data?	Yes, No	Save or discard calibration data?

7.2.1 Calibrate cell constant

A conductivity measurement system is always calibrated such that the exact cell constant is determined/verified using suitable calibration solutions. This method is described, for example, in the EN 7888 and ASTM D 1125 standards, each of which details the manufacture of a few calibration solutions. Another option is to obtain international calibration standards from government metrology authorities. This is particularly important in the pharmaceutical industry, where traceability of the calibration to internationally recognized standards is mandatory. To calibrate its test equipment, Endress+Hauser uses the SRM (Special Reference Material) of the US government agency NIST (National Institute of Standards and Technology).

Calibrating the cell constant

In the cell constant calibration, always use a defined conductivity reference solution with raw conductance values that are specified at the various temperatures. The correct calibration always takes place without temperature compensation.

Setting: In the menus, navigate to **Extended Setup** → **Input** → **T.comp.cal**: Select "off".

This switches off the temperature compensation for the calibration.

The new cell constant is calculated from the new conductivity reference solution.

The method for cell constant calibration is the same for conductive and inductive conductivity. Only the conductivity reference or standard solutions that are adapted to the measuring ranges may be used.

For the conductive sensors (CLS15D, CLS16D and CLS21D), standard solution CLY11-A 74.02 $\mu\text{S/cm}$, CLY11-B 149.75 $\mu\text{S/cm}$.

For the inductive sensor (CLS50D), standard solution CLY11-C 1.40 mS/cm , CLY11-D 12.65 mS/cm .

1. Press "E" to call up the main menu.
2. Press the "+" button to navigate to the "Calibration" menu.
3. Press "E" to open the menu.
4. Press "E" to open the "Cell const." submenu.
 - ↳ The current cell constant is displayed.
5. Remove the sensor from the measurement medium, flush with distilled water and dry.
6. Press "+" to enter the conductivity reference solution "cond. Ref."
 - ↳ Entering the value of the conductivity reference solution at the current temperature
7. Press "+".
 - ↳ "Insert sensor in med." is displayed.
8. Insert the sensor into the conductivity reference solution.
9. Press "+".
 - ↳ "wait for stable value" is displayed.
Display reads "wait for stable value", when the value is stable, the display switches to "New cell constant".
10. Press "+".
 - ↳ "Save Calib. Data" is displayed.
Press E and apply calibration data using "Yes".

8 Maintenance

No special maintenance work is required on the device.

9 Accessories

9.1 Sensors

Conductive conductivity sensors

Condumax W CLS15D

- Conductive conductivity sensor for pure water, ultrapure water and Ex applications
- Order as per product structure, see Technical Information TI00109C/07/en

Condumax H CLS16D

- Hygienic, conductive conductivity sensor for pure water, ultrapure water and Ex applications
- With EHEDG and 3A approval
- Order depending on version, see Technical Information TI00227C/07/en

Condumax W CLS21D

- Two-electrode sensor in plug-in head and fixed cable version
- Order as per product structure, see Technical Information TI00085C/07/en

Inductive conductivity sensors

Indumax CLS50D

- Highly resistant inductive conductivity sensor for standard, Ex and high-temperature applications
- Memosens protocol
- Order as per product structure, see Technical Information TI00182C/07/en

10 Troubleshooting

To help you troubleshoot, the following section is designed to provide an overview of possible causes of errors and initial remedial measures.

10.1 Troubleshooting instructions

WARNING

Danger! Electric voltage!

- ▶ Do not operate the device in an open condition for error diagnosis!

User interface	Reason	Solution
No measured value displayed	No power supply connected	Check the power supply to the device.
	Power is supplied, device is defective	The device must be replaced.
Diagnostic message is displayed	The list of diagnostic messages is provided in the following section.	

10.2 Diagnostic messages

The diagnostic message consists of a diagnostic code and a message text.

The diagnostic code consists of an error category according to Namur NE 107 and a message number.

Error category (character front of message number)

- F = Failure, a malfunction has been detected.
The measured value of the respective channel is no longer reliable. The cause can be found at the measuring point. If a control system is connected, you should switch to manual operation.
- M = Maintenance required, action has to be taken as soon as possible.
Functionality of the measurement is fulfilled. No immediate measure needs to be taken. However, maintenance prevents possible future malfunction.
- C = Function check, wait loop (no error).
Maintenance is performed on the device. Wait for completion of the process.
- S = Out of specification, the measurement point is operated out of specification.
Measurement is still possible. However, operation takes place with risk of higher wear, shortened lifespan or lower measurement accuracy. The cause can be found at the measurement point.

Examples:

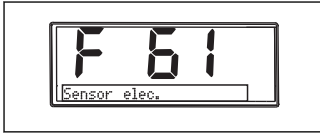

A0015896

F 61
sensor elec.

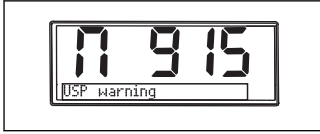

A0015897

M 915
USP warning



A0015898

S 844
Process value



A0015899

C 107
Calib. active

Diagnostic code	Message text	Description
F5	Sensor data	Sensor data invalid. Remedy: <ul style="list-style-type: none"> ▪ Update date of the transmitter ▪ Replace sensor
F12	Writing data	The sensor data could not be written. Remedy: <ul style="list-style-type: none"> ▪ Repeat writing of the sensor data ▪ Replace sensor
F13	Sensor type	Incorrect sensor type. Remedy: Switch to a sensor of the configured type.
F61	Sensor elec.	Sensor electronics defective. Remedy: <ul style="list-style-type: none"> ▪ Replace sensor ▪ Contact service
F62	Sens. Connect	Sensor connection. Remedy: <ul style="list-style-type: none"> ▪ Replace sensor ▪ Contact service

Diagnostic code	Message text	Description
F100	Sensor comm.	<p>No sensor communication.</p> <p>Possible reasons:</p> <ul style="list-style-type: none"> ▪ No sensor connection ▪ Faulty sensor connection ▪ Short-circuit in the sensor cable ▪ Short-circuit in the neighboring channel ▪ Sensor firmware update canceled with an error <p>Remedy:</p> <ul style="list-style-type: none"> ▪ Check sensor cable connection ▪ Check sensor cable for short-circuit ▪ Replace sensor ▪ Restart firmware update ▪ Contact service
F130	Sensor supply	<p>Sensor check. Poor energy supply to sensor.</p> <p>Remedy:</p> <ul style="list-style-type: none"> ▪ Check cable connections ▪ Replace sensor
F142	Sensor signal	<p>Sensor check. No conductivity display.</p> <p>Possible reasons:</p> <ul style="list-style-type: none"> ▪ Sensor in air ▪ Sensor defective <p>Remedy:</p> <ul style="list-style-type: none"> ▪ Check sensor installation ▪ Replace sensor
F143	Self test	<p>Sensor self-test error.</p> <p>Remedy:</p> <ul style="list-style-type: none"> ▪ Replace sensor ▪ Contact service
F152	No airset	<p>Sensor data. No calibration data present</p> <p>Remedy: Carry out airset calibration</p>
F523	Cell const.	<p>Sensor calibration warning. Invalid cell constant, max. range reached.</p> <p>Remedy:</p> <ul style="list-style-type: none"> ▪ Recalibrate ▪ Enter cell constant according to factory specifications ▪ Replace sensor
F524	Cell const.	<p>Sensor calibration alarm. Min. possible cell constant undershot.</p> <p>Remedy:</p> <ul style="list-style-type: none"> ▪ Recalibrate ▪ Enter cell constant according to factory specifications

Diagnostic code	Message text	Description
F845	Device id	Faulty hardware configuration
F846	Param error	Faulty parameter checksum Possible cause: Firmware update Remedy: Reset parameters to factory defaults
F847	Couldn't save param	Parameters could not be saved
F848	Calib AO1	Faulty calibration values for analog output 1
F849	Calib AO2	Faulty calibration values for analog output 2
F904	Process check	Process check system alarm. No change in measurement signal for a long time. Possible reasons <ul style="list-style-type: none"> ▪ Sensor dirty or in air ▪ No sensor inflow ▪ Sensor defective ▪ Software error Remedy: <ul style="list-style-type: none"> ▪ Check measuring chain ▪ Inspect sensor ▪ Carry out software restart

Diagnostic code	Message text	Description
C107	Calib. active	Sensor calibration is active. Remedy: Wait for calibration
C154	No calib. data	Sensor data. No calibration data present, factory settings will be used. Remedy: <ul style="list-style-type: none"> ▪ Check calibration information of the sensor ▪ Calibrate cell constant
C850	Simu AO1	Simulation of analog output 1 is active
C851	Simu AO2	Simulation of analog output 2 is active
C852	Simu DO	Simulation of status output is active
C853	Download act.	Parameter transmission is active

Diagnostic code	Message text	Description
S844	Process value	<p>Measured value outside the specified range.</p> <p>Possible reasons:</p> <ul style="list-style-type: none"> ▪ Sensor in air ▪ Air cushion in the assembly ▪ Incorrect sensor inflow ▪ Sensor defective <p>Remedy:</p> <ul style="list-style-type: none"> ▪ Increase process value ▪ Check measuring chain ▪ Change sensor type
S910	Limit switch	Limit switch energized

Diagnostic code	Message text	Description
M500	Not stable	<p>Sensor calibration canceled. Main measured value unsteady.</p> <p>Possible reasons:</p> <ul style="list-style-type: none"> ▪ Sensor overaged ▪ Sensor temporarily dry ▪ Buffer value not constant <p>Remedy:</p> <ul style="list-style-type: none"> ▪ Check sensor, replace if required ▪ Check buffer
M526	Cell const.	<p>Sensor calibration warning. Invalid cell constant, max. range reached.</p> <p>Remedy:</p> <ul style="list-style-type: none"> ▪ Recalibrate ▪ Enter cell constant according to factory specifications ▪ Replace sensor
M528	Cell const.	<p>Sensor calibration warning. Min. possible cell constant undershot.</p> <p>Remedy:</p> <ul style="list-style-type: none"> ▪ Recalibrate ▪ Enter cell constant according to factory specifications
M914	USP alarm	<p>USP alarm. Conductivity limit value for USP exceeded.</p> <p>Remedy: Check process</p>
M915	USP warning	<p>USP warning. Conductivity limit value for USP undershot.</p> <p>Remedy: Check process</p>

10.3 Firmware history

Revision history

The firmware version (FW) on the nameplate and in the Operating Instructions indicates the device release: XX.YY.ZZ (example 01.02.01).

- XX Change to main version. No longer compatible. The device and Operating Instructions change.
- YY Change to functions and operation. Compatible. The Operating Instructions change.
- ZZ Fixes and internal changes. No changes to the Operating Instructions.

Date	Firmware Version	Changes	Documentation
09/2011	01.01.00	Original firmware	BA01030C/09/en/01.11
11/2019	02.01.00	Password protection for users amended	BA01030C/09/en/02.19

10.4 Spare parts

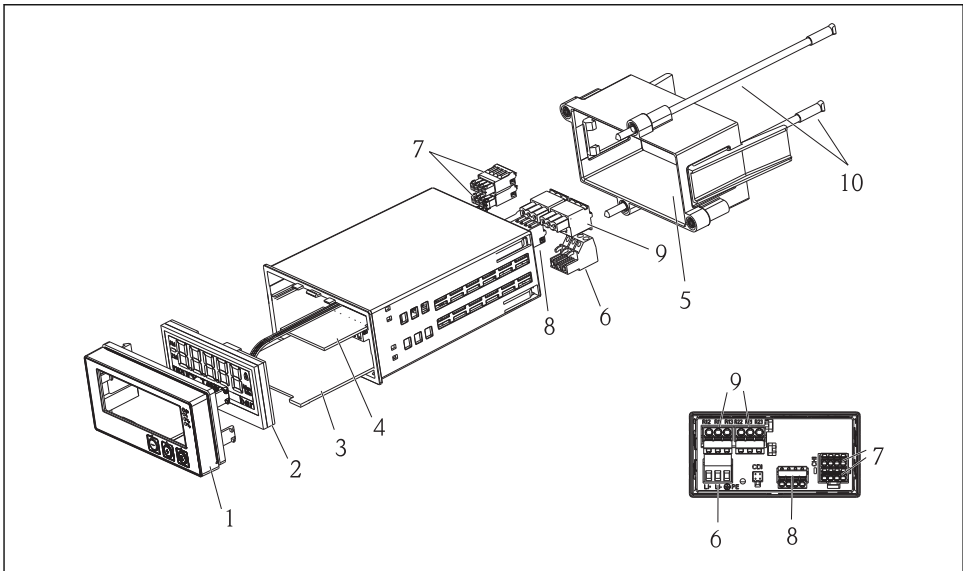

A0015745

6 Spare parts of the device

Item no.	Description	Order no.
1	Housing front + foil, incl. keyboard CM14, without display	XPM0004-DA
2	CPU/Display board CM14 conductivity conductive CPU/Display board CM14 conductivity inductive	XPM0004-CK XPM0004-CL
3	Mainboard 24-230VDC/AC, CM14	XPM0004-NA
4	Relay board + 2 limit relays	RIA45X-RA
5	Fixing frame for housing W07	71069917
6	Terminal, 3-pole (power supply)	50078843
7	Pluggable terminal, 4-pole (Memosens input)	71037350
8	Pluggable terminal, 4-pole (current output)	71075062
9	Pluggable terminal, 3-pole (relay terminal)	71037408
10	Threaded bar for tube fixing clip 105mm	71081257

10.5 Return

For a return, e.g. in case of repair, the device must be sent in protective packaging. The original packaging offers the best protection. Repairs must only be carried out by your supplier's service organization.



When sending for repair, please enclose a note with a description of the error and the application.

10.6 Disposal

The device contains electronic components and must, therefore, be disposed of as electronic waste in the event of disposal. Please pay particular attention to the local regulations governing waste disposal in your country.

11 Technical data

11.1 Input

11.1.1 Measured variables

--> Documentation of the connected sensor

11.1.2 Measuring ranges

--> Documentation of the connected sensor

11.1.3 Input types

Digital sensor inputs, Memosens and Memosens protocol

11.1.4 Cable specification

Cable type

Memosens data cable or fixed sensor cable, each with cable end sleeves

Cable length

Max. 100 m (330 ft)

11.2 Output

11.2.1 Output signal

2 x 0/4 to 20 mA active, potentially isolated from the sensor circuits and from each other

11.2.2 Load

Max. 500 Ω

11.2.3 Linearization/transmission behavior

Linear

11.2.4 Alarm output

The alarm output is designed as an "open collector." In normal operation the alarm output is closed. In the event of a fault (F-fault, device without current) the "open collector" opens.

Current max. 200 mA

Voltage max. 30 V DC

11.3 Current outputs, active

11.3.1 Span

0 to 23 mA

11.3.2 Signal characterization

Linear

11.3.3 Electrical specification

Output voltage

Max. 24 V

11.3.4 Cable specification

Cable type

Recommendation: shielded line

Cross-section

Max. 1.5 mm² (16 AWG)

11.4 Relay outputs

11.4.1 Relay types

2 changeover contacts

11.4.2 Relay switching capacity

Max. 3 A 24 V DC

Max. 3 A 253 V AC

Min. 100 mW (5 V / 10 mA)

11.4.3 Cable specification

Cross-section

Max. 2.5 mm² (14 AWG)

11.5 Wiring

11.5.1 Electrical connection

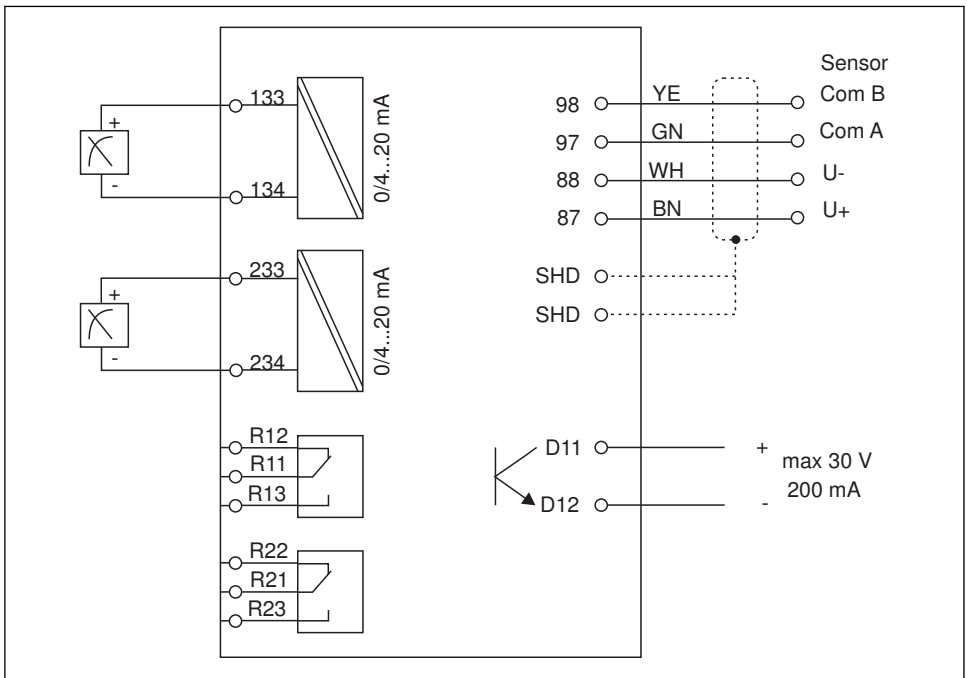

A0015303

Connection	Description
87	Terminal for Memosens cable, brown, sensor power supply U+
88	Terminal for Memosens cable, white, sensor power supply U-
97	Terminal for Memosens cable, green, Com A
98	Terminal for Memosens cable, yellow, Com B
SHD	Terminal for Memosens cable, shield
D11	Terminal for alarm output, +
D12	Terminal for alarm output, -
L/+	Terminal for transmitter supply voltage
N/-	
⊕ PE	
133	Terminal for analog output 1, +
134	Terminal for analog output 1, -
233	Terminal for analog output 2, +
234	Terminal for analog output 2, -
R11, R12, R13	Terminal for relay 1
R21, R22, R23	Terminal for relay 2

11.5.2 Supply voltage

Wide range power unit 24 to 230 V AC/DC (-20 % / +10 %) 50/60Hz



The device does not have a power switch

- The customer must provide a protected circuit breaker in the vicinity of the device.
- The circuit breaker must be a switch or power switch, and must be labeled as the circuit breaker for the device.

11.5.3 Power consumption

Max. 13.8 VA / 6.6 W

11.6 Performance characteristics

11.6.1 Response time

Current outputs

t_{90} = max. 500 ms for a jump from 0 to 20 mA

11.6.2 Reference temperature

25 °C (77 °F)

11.6.3 Maximum measured error of inputs

--> Documentation of the connected sensor

11.6.4 Resolution of current output

> 13 bit

11.6.5 Repeatability

--> Documentation of the connected sensor

11.7 Mounting conditions

11.7.1 Installation instructions

Mounting location

Panel, cutout 92 x 45 mm (3.62 x 1.77 in)

Max. panel thickness 26 mm (1 in)

Installation position

The orientation is determined by the legibility of the display.

Max. viewing angle range of +/- 45° from the central display axis in every direction.

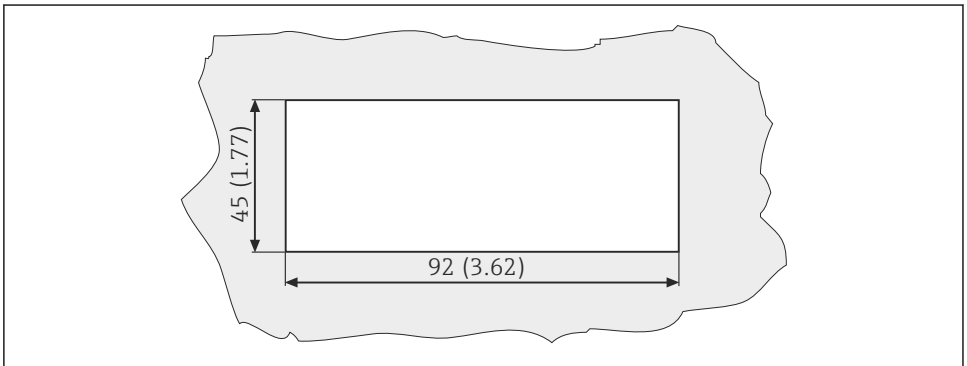

A0010351

 7 Panel cutout, dimensions in mm (in)

11.8 Environment

11.8.1 Ambient temperature range

-10 to +60 °C (14 to 140 °F)

11.8.2 Storage temperature

-40 to +85 °C (-40 to +185 °F)

11.8.3 Operating height

< 2 000 m (6 561 ft) above MSL

11.8.4 Electromagnetic compatibility

Emitted interference and interference immunity to EN 61326-1:2006, Class A for industrial areas

11.8.5 Degree of protection

Front

Front IP65 / NEMA 4X

Tube

Shock protection IP20

11.8.6 Relative humidity

5 to 85 %, non-condensing

11.9 Mechanical construction

11.9.1 Dimensions

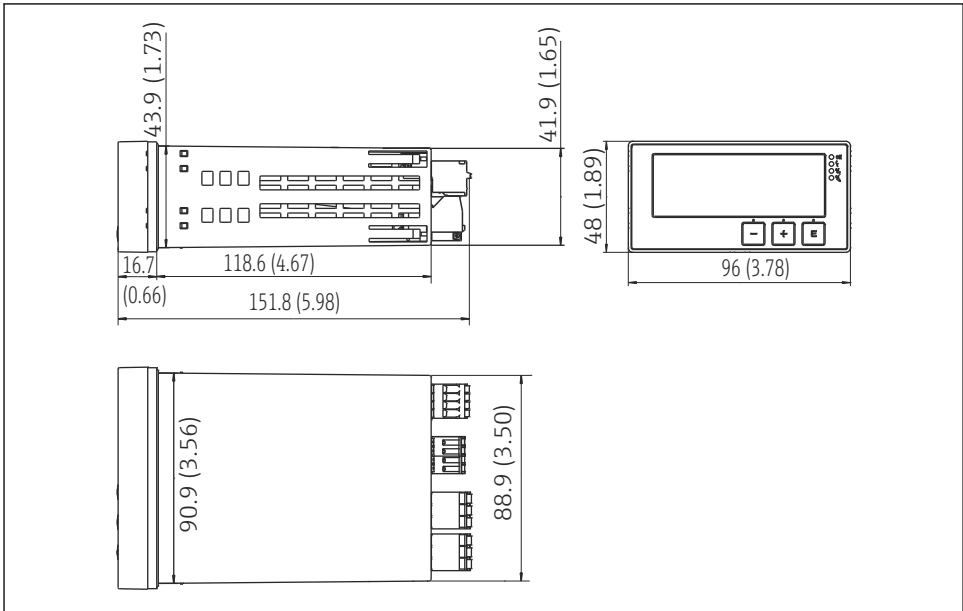

A0015925

8 Dimensions of the transmitter in mm (in)

11.9.2 Weight

0.3 kg (0.66 lbs)

11.9.3 Materials

Housing, casing: Polycarbonate
 Front foil: Polyester, UV-resistant

11.9.4 Terminals

Max. 2.5 mm² (22-14 AWG; tightening torque 0.4 Nm (3.5 lb in)) line, relay

11.10 Display and operating elements

11.10.1 Operating elements

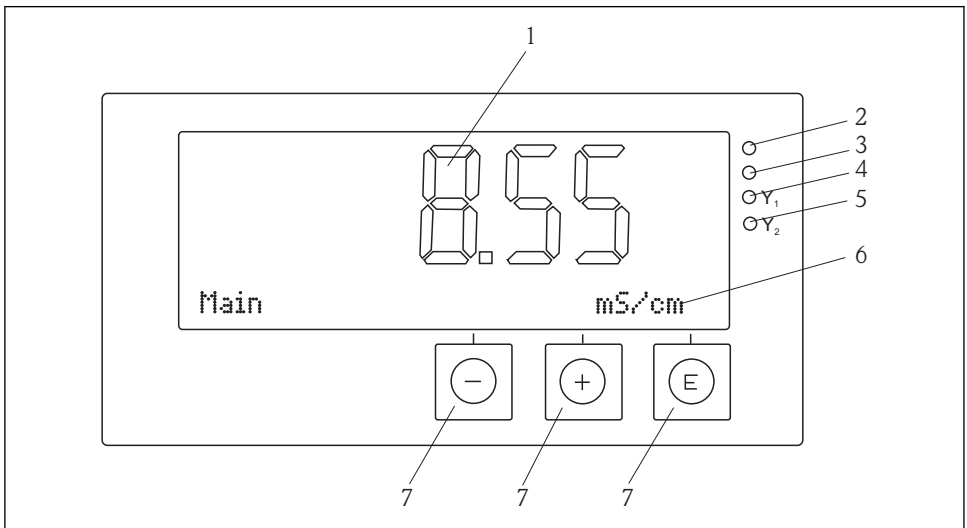

A0018699

9 Display and operating elements

- 1 LC display for displaying the measured values and configuration data
- 2 Status LED, power supply connected
- 3 Status LED, alarm function
- 4 Status LED for limit switch relay 1
- 5 Status LED for limit switch relay 2
- 6 Dot matrix display for displaying the dimensions and menu items
- 7 Operating keys

11.11 Certificates and approvals

11.11.1 CE mark

Declaration of Conformity

The product fulfills the requirements of harmonized European standards.

Thus it fulfills the legal requirements of the EC Directives.

The manufacturer confirms successful testing of the device by affixing to it the CE mark.

Other standards and guidelines

- IEC 60529:
Degree of protection by housing (IP code)
- IEC 61010-1: 2001 Cor 2003
Safety requirements for electrical equipment for measurement, control and laboratory use

Index

C

Calibration

Cell constant 28

CE mark 8

D

Device configuration

Setup access protection 17

Diagnostic messages 31

Display symbols 15

E

Error messages 31

European Pharmacopoeia (EP) 25

I

Icons

Display 15

Editing mode 15

Installation factor 22

O

Operational safety 4

R

Relay 22, 25

S

Staff

Requirements 4

T

Temperature compensation 23

U

United States Pharmacopoeia (USP) 25

W

Workplace safety 4

www.addresses.endress.com
