

Operating Instructions

CM14

Transmitter, pH and ORP

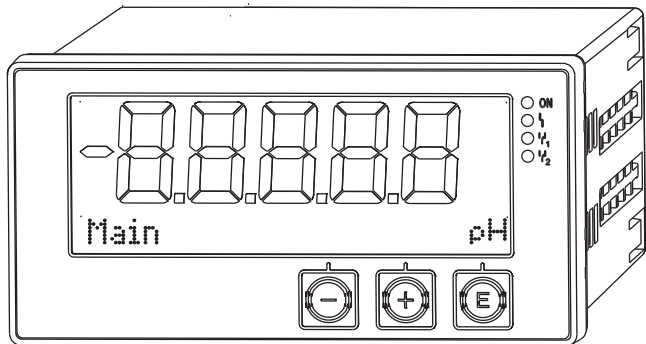

Table of contents

1	Safety instructions	4	7	Calibration and adjustment ..	23
1.1	Workplace safety	4	7.1	Definitions	23
1.2	Requirements concerning the staff	4	7.2	pH sensors	23
1.3	Operational safety	4	7.3	ORP sensors	25
1.4	Designated use	5	7.4	Device functions for calibration	26
1.5	Technical improvement	5	8	Maintenance	26
1.6	Return	5	9	Accessories	27
1.7	Notes on safety conventions and icons	5	9.1	Sensors	27
2	Identification	7	10	Troubleshooting	28
2.1	Device name	7	10.1	Troubleshooting instructions	28
2.2	Scope of delivery	7	10.2	Diagnostic messages	28
2.3	Certificates and approvals	8	10.3	Firmware history	32
3	Installation	9	10.4	Spare parts	33
3.1	Incoming acceptance, transport, storage	9	10.5	Return	34
3.2	Installation	9	10.6	Disposal	34
3.3	Dimensions	9	11	Technical data	34
3.4	Installation procedure	10	11.1	Input	34
3.5	Post-installation check	10	11.2	Output	34
4	Wiring	11	11.3	Current outputs, active	35
4.1	Connecting the transmitter	12	11.4	Relay outputs	35
4.2	Post-connection check	13	11.5	Wiring	36
5	Operation	14	11.6	Performance characteristics	37
5.1	Display and device status indicator / LED	14	11.7	Mounting conditions	37
5.2	Local operation at the device	14	11.8	Environment	38
5.3	Icons	15	11.9	Mechanical construction	39
5.4	Operating functions	16	11.10	Display and operating elements	40
5.5	Hold function	16	11.11	Certificates and approvals	40
6	Commissioning	17	Index	41	
6.1	Post-installation check and switching on the device	17			
6.2	Display settings (Display menu)	17			
6.3	Notes on setup access protection	17			
6.4	Configuration of the device (Setup menu)	18			
6.5	Extended configuration (Extended setup menu)	19			
6.6	Device diagnostics (Diagnostics menu)	22			

1 Safety instructions

Safe operation of the transmitter is only guaranteed if these Operating Instructions have been read and the safety instructions have been observed.

1.1 Workplace safety

For work on and with the device:

- ▶ Wear the required personal protective equipment according to federal/national regulations.

If working on and with the device with wet hands:

- ▶ Due to the increased risk of electric shock, gloves must be worn.

1.2 Requirements concerning the staff

The personnel for installation, commissioning, diagnostics and maintenance must fulfill the following requirements:

- ▶ Trained, qualified specialists: must have a relevant qualification for this specific function and task
- ▶ Are authorized by the plant owner/operator
- ▶ Are familiar with federal/national regulations
- ▶ Before beginning work, the specialist staff must have read and understood the instructions in the Operating Instructions and supplementary documentation as well as in the certificates (depending on the application)
- ▶ Following instructions and basic conditions

The operating personnel must fulfill the following requirements:

- ▶ Being instructed and authorized according to the requirements of the task by the facility's owner-operator
- ▶ Following the instructions in these Operating Instructions

1.3 Operational safety

Risk of injury.

- ▶ Operate the device in proper technical condition and fail-safe condition only.
- ▶ The operator is responsible for interference-free operation of the device.

Conversions to the device

Unauthorized modifications to the device are not permitted and can lead to unforeseeable dangers.

- ▶ If, despite this, modifications are required, consult with Endress+Hauser.

Repair

To ensure continued operational safety and reliability,

- ▶ Carry out repairs on the device only if they are expressly permitted.
- ▶ Observe federal/national regulations pertaining to repair of an electrical device.
- ▶ Use original spare parts and accessories from Endress+Hauser only.

1.4 Designated use

The transmitter evaluates measured values of an analytical sensor and visualizes them on its multicolored display. Processes can be monitored and controlled with the unit's outputs and limit relays. The device is equipped with a wide array of software functions for this purpose.

- The manufacturer does not accept liability for damage caused by improper or non-designated use. The device may not be converted or modified in any way.
- The device is designed for installation in a panel and must only be operated in an installed state.

1.5 Technical improvement

The manufacturer reserves the right to adapt technical details to the most up-to-date technical developments without any special announcement. Please contact your sales center for information on modifications or updates to the Operating Instructions.

1.6 Return

For a return, e.g. in case of repair, the device must be sent in protective packaging. The original packaging offers the best protection. Repairs must only be carried out by your supplier's service organization.



When returning the device for repair, enclose a note with a description of the problem and the application.

1.7 Notes on safety conventions and icons

1.7.1 Warnings



Causes (/consequences)

Consequences of non-compliance (if applicable)

- ▶ Corrective action
- ▶ This symbol alerts you to a dangerous situation. Failure to avoid the situation will result in a fatal or serious injury.



Causes (/consequences)

Consequences of non-compliance (if applicable)

- ▶ Corrective action
- ▶ This symbol alerts you to a dangerous situation. Failure to avoid the situation can result in a fatal or serious injury.



Causes (/consequences)

Consequences of non-compliance (if applicable)







- ▶ Corrective action
- ▶ This symbol alerts you to a dangerous situation. Failure to avoid this situation can result in minor or more serious injuries.

NOTICE**Causes (/consequences)**

Consequences of non-compliance (if applicable)

- ▶ Corrective action
- ▶ This symbol alerts you to situations which may result in damage to property.

1.7.2 Document symbols

- | | |
|---|---|
|  | Allowed
Indicates procedures, processes or actions that are allowed. |
|  | Preferred
Indicates procedures, processes or actions that are preferred. |
|  | Forbidden
Indicates procedures, processes or actions that are forbidden. |
|  | Additional information, tips |
|  | Reference to documentation |
|  | Reference to a page in this manual |
|  | Reference to a graphic |

2 Identification

2.1 Device name

2.1.1 Nameplate

Compare the nameplate with the following diagram:

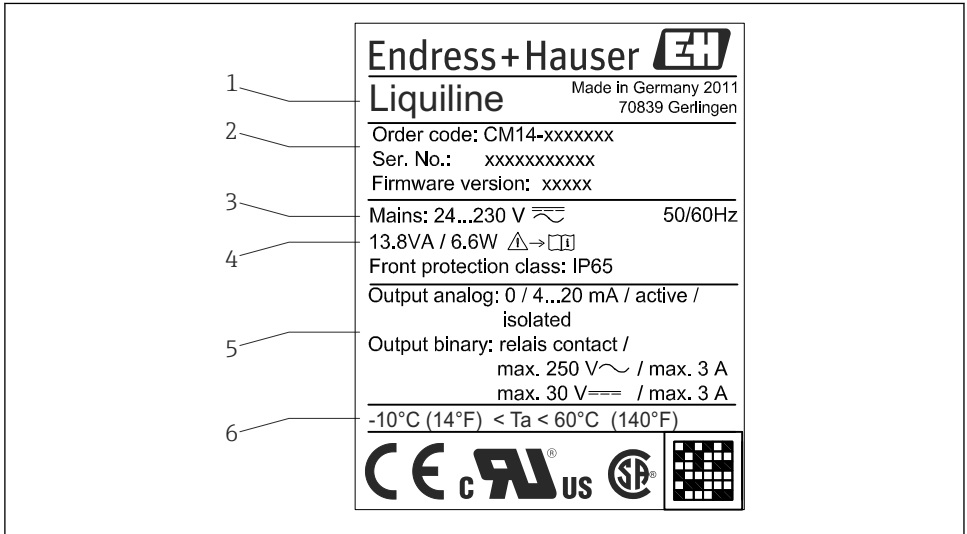

A0015221

1 Nameplate of the transmitter (example)

- 1 Device name
- 2 Device order code, serial number and ID number
- 3 Power supply
- 4 Power consumption
- 5 Output values
- 6 Temperature range

2.2 Scope of delivery

The scope of delivery of the transmitter comprises:

- Transmitter for panel mounting
- Operating Instructions
- Fastening fixtures

2.3 Certificates and approvals

2.3.1 CE mark

The product meets the requirements of the harmonized European standards. As such, it complies with the legal specifications of the EC directives. The manufacturer confirms successful testing of the product by affixing to it the CE-mark.

2.3.2 EAC mark

The product meets the legal requirements of the EEU guidelines. The manufacturer confirms the successful testing of the product by affixing the EAC mark.

3 Installation

3.1 Incoming acceptance, transport, storage

The permitted ambient and storage conditions must be observed. The precise specifications can be found in Section "Technical data" →  34.

3.1.1 Incoming acceptance

On receipt of the goods, check the following points:

- Are the packaging or contents damaged?
- Is anything missing from the delivery? Compare the scope of delivery with the information you specified in the order.

3.1.2 Transportation and storage

Note the following points:

- Pack the device so that is protected against impact for storage and transportation. The original packaging provides optimum protection.
- The permitted storage temperature range is -40 to $+85$ °C (-40 to $+185$ °F); it is possible to store the device in the borderline temperature ranges for a limited period (maximum 48 hours).

3.2 Installation

NOTICE

Overheating due to heat accumulation in the device

- ▶ To avoid heat accumulation, please always make sure the device is sufficiently cooled.



If the device is operated in the upper temperature limit range, this reduces the operating life of the display.

The transmitter is designed to be used in a panel.

The orientation is determined by the readability of the display. Connections and outputs are fitted on the rear of the device. The wires are connected by means of number-coded terminals.

Ambient temperature range: -10 to $+60$ °C (14 to 140 °F)

3.3 Dimensions

Observe the installation depth of 150 mm (5.91 ") for the device incl. terminals and fastening clips.

More dimensions can be found in Section "Technical data" →  34.

- Panel cutout: 92 mm x 45 mm (3.62 in x 1.77 in).
- Panel thickness: max. 26 mm (1 in).
- Max. viewing angle range: 45° to the left and right from the central display axis.
- If the devices are arranged horizontally beside one another in the X-direction, or arranged vertically on top of one another in the Y-direction, the mechanical distance (specified by the housing and front section) must be observed.

3.4 Installation procedure

The required panel cutout is 92 mm x 45 mm (3.62 in x 1.77 in).

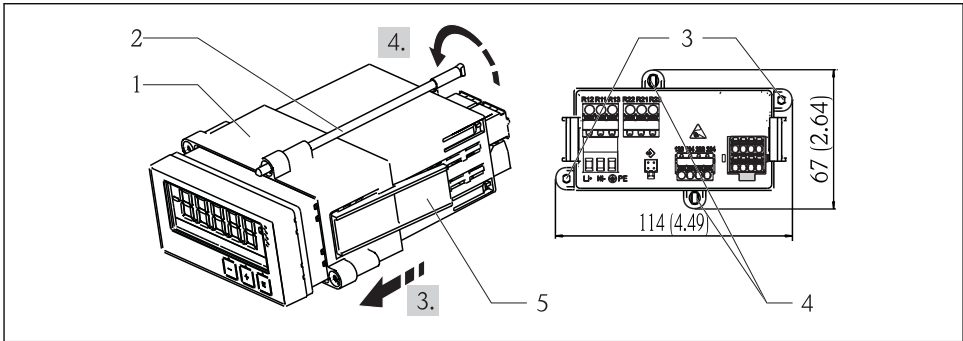

A0015216

2 Installation in the panel

1. Screw the threaded rods (item 2) into the positions provided on the mounting frame (item 1). Four opposing screw positions (item 3/4) are available for this purpose.
2. Push the device with the sealing ring through the panel cutout from the front.
3. To secure the tube in the panel, hold the device in a horizontal position and push the installation frame (item 1), with the threaded rods screwed in, over the tube until the frame locks into position.
4. Tighten the threaded rods to fasten the device in place.

To disassemble the device, the mounting frame can be unlocked at the locking elements (item 5) and then removed.

3.5 Post-installation check

- Is the sealing ring undamaged?
- Is the mounting frame securely engaged on the housing of the device?
- Are the threaded rods tightened?
- Is the device positioned in the center of the panel cutout?

4 Wiring

WARNING

Danger from electrical voltage

- ▶ The entire connection of the electrical system must take place while the device is de-energized.

Danger if protective ground is interrupted

- ▶ The protective ground connection must be established before any other connection is made.

NOTICE

Thermal load of the lines

- ▶ Use suitable lines for temperatures of 5 °C (9 °F) above ambient temperature.

Malfunction or destruction of the device due to incorrect supply voltage

- ▶ Prior to commissioning, make sure the supply voltage matches the specifications on the nameplate (bottom side of the housing).

Ensure the emergency shutoff of the device

- ▶ Provide a suitable switch or power-circuit breaker in the building installation. This switch must be provided within easy reach of the device and be labeled as a disconnecter.

Protect device from overload

- ▶ Provide a overload protection unit (rated current = 10 A) for the power supply line.

Incorrect wiring can cause destruction of the device

- ▶ Observe the terminal designation on the rear of the device.

Energy-rich transients in long signal lines

- ▶ Connect suitable upstream overvoltage protection in series.



It is permitted to connect a mixture of safety extra low voltage and voltage which poses a shock hazard to the relays.

4.1 Connecting the transmitter

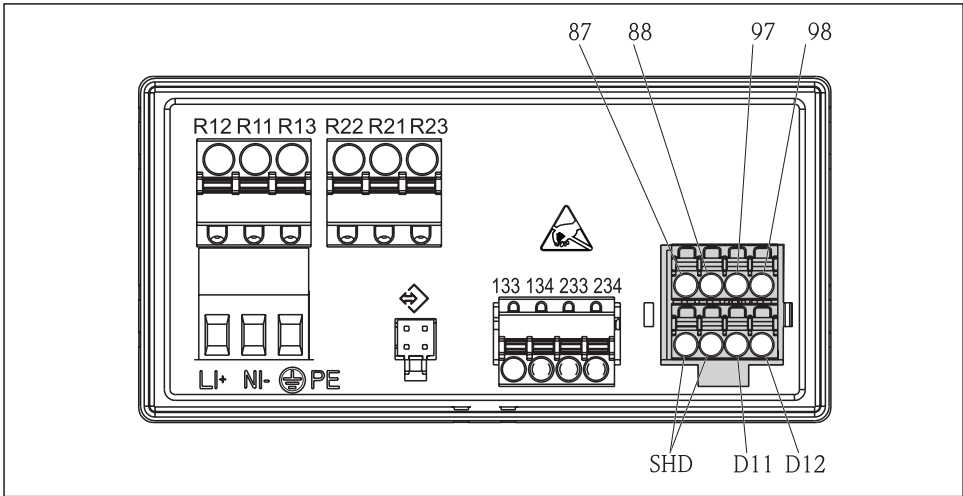



A0015215

3 Connection diagram of the transmitter

Terminal	Description
87	Terminal for Memosens cable, brown, sensor power supply U+
88	Terminal for Memosens cable, white, sensor power supply U-
97	Terminal for Memosens cable, green, Com A
98	Terminal for Memosens cable, yellow, Com B
SHD	Terminal for Memosens cable, shield
D11	Terminal for alarm output, +
D12	Terminal for alarm output, -
L/+	Terminal for transmitter supply voltage
N/-	
⊕ PE	
133	Terminal for analog output 1, +
134	Terminal for analog output 1, -
233	Terminal for analog output 2, +
234	Terminal for analog output 2, -
R11, R12, R13	Terminal for relay 1
R21, R22, R23	Terminal for relay 2

4.2 Post-connection check

Device condition and specifications	Notes
Are the device or cables damaged?	Visual inspection
Electrical connection	Notes
Does the supply voltage match the specifications on the nameplate?	24 to 230 V AC/DC (-20 % / +10 %) 50/60 Hz
Are all of the terminals firmly engaged in their correct slots? Is the coding on the individual terminals correct?	-
Are the mounted cables strain-relieved?	-
Are the supply voltage and signal cables connected correctly?	See connection diagram, →  3,  12 and on the housing.

5 Operation

The device's simple operating concept enables you to perform commissioning for many applications without the need for hardcopy operating instructions.

5.1 Display and device status indicator / LED

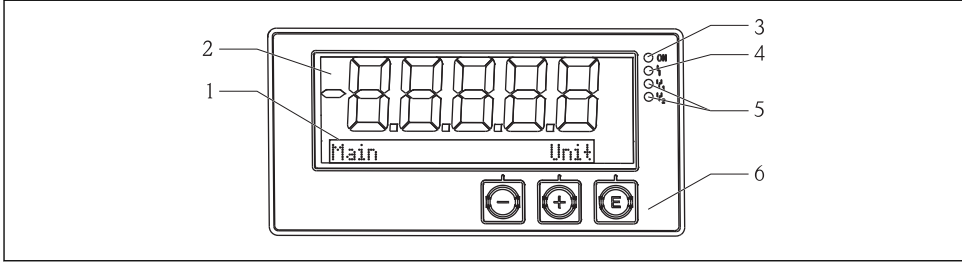

A0015891

4 Device display

- 1 Dot matrix section
- 2 7-segment display
- 3 LED status indicator, power supply connected
- 4 LED status indicator, alarm function
- 5 LED status indicator, limit switch relay 1/2
- 6 Operating keys

The device offers users a backlit LC display which is divided into two sections. The segment section displays the measured value.

In the dot matrix section, additional channel information, such as the TAG, unit or bar graph, is shown in the display mode. Operating text in English is displayed here during operation.

The parameters for configuring the display are explained in detail in the "Commissioning" section.

In the event of an error, the device automatically switches between displaying the error and displaying the channel, see the "Device diagnostics" → 22 and "Troubleshooting" → 28 sections.

5.2 Local operation at the device

The device is operated using the three keys integrated in the front of the device





- Open the Configuration menu
- Confirm an entry
- Select a parameter or submenu offered in the menu

Within the Configuration menu:

- Gradually scroll through the parameters / menu items / characters offered
- Change the value of the selected parameter (increase or decrease)



Outside the Configuration menu:



Display enabled and calculated channels, as well as minimum and maximum values, for all the active channels.

You can always exit menu items / submenus by selecting "x Back" at the end of the menu.

Leave the setup directly without saving the changes by pressing the '-' and '+' keys simultaneously for longer (> 3 s).

5.3 Icons

5.3.1 Display symbols

	Hold function →  16 active.
Max	Maximum value/value of the maximum indicator of the channel displayed
Min	Minimum value/value of the minimum indicator of the channel displayed
-----	Error, under/over range. No measured value is displayed.
	The device is locked / operator lock; the device setup is locked for changes to parameters; the display can be changed.

 The error and the channel identifier (TAG) are specified in the dot matrix section.





5.3.2 Icons in the editing mode

The following characters can be used to enter user-defined text:

'0-9', 'a-z', 'A-Z', '+', '-', '*', '/', '\', '%', '°', '2', '3', 'm', ':', ';', ':', '!', '?', '_', '#', '\$', '"', ',', '(', ')', '~',

For numerical entries, the numbers '0-9' and the decimal point are available.

Furthermore, the following icons are used in the editing mode:

	Symbol for setup
	Symbol for expert setup
	Symbol for diagnostics
	Accept entry. If this symbol is selected, the entry is applied at the position specified by the user, and you quit editing mode.

✘	Reject entry. If this symbol is selected, the entry is rejected and you quit editing mode. The previously set text remains.
+	Jump one position to the left. If this symbol is selected, the cursor jumps one position to the left.
⬅	Delete backwards. If this symbol is selected, the character to the left of the cursor position is deleted.
☒	Delete all. if this symbol is selected, the entire entry is deleted.

5.4 Operating functions

The operating functions of the transmitter are organized into the following menus:

Display	Settings for the device display: contrast, brightness, time for alternating measured values on the display
Setup	Device settings A description of the individual settings is provided in the "Commissioning" section → 17.
Calibration	Execution of the sensor calibration A description of the functions for calibration is provided in the "Calibration" section.
Diagnostics	Device information, diagnostics logbook, sensor information, simulation

5.5 Hold function

The hold function causes the current outputs and relay states to "freeze". This function can be switched on and off manually (menu **Setup** → **Manual hold**). In addition, the hold function is automatically activated during sensor calibration.

When the hold condition no longer applies, the hold function continues to be active for the configurable hold release time. The hold release time is configured in the menu **Setup** → **Extended setup** → **System** → **Hold release**.

The hold function does not affect the display of the measured value. The hold symbol is also displayed after the measured value.

6 Commissioning

6.1 Post-installation check and switching on the device

Make sure that all post-connection checks have been carried out before you commission your device:

- Checklist for "post-installation check", →  10.
- Checklist for "post-connection check", →  13.

After the operating voltage is applied, the green LED lights up and the display indicates the device is ready for operation.

If you are commissioning the device for the first time, program the setup as described in the following sections of the Operating Instructions.

When commissioning a device already configured or preset, measuring is immediately started as per the settings. The values of the channels currently activated are shown on the display.



Remove the protective film from the display as this would otherwise affect the readability of the display.

6.2 Display settings (Display menu)

You can access the main menu by pressing the 'E' key during operation. The Display menu appears on the display. Press the 'E' key again to open the menu. Use the "x Back" option, which can be found at the bottom of each menu/submenu, to move up one level in the menu structure.

Parameters	Possible settings	Description
Contrast	1-7 Default: 6	Setting for the display contrast.
Brightness	1-7 Default: 6	Setting for the brightness of the display.
Alternating time	0, 3, 5, 10 sec	Switching time between the two measured values. 0 means that the values do not alternate on the display.

6.3 Notes on setup access protection





Access to the setup is enabled by default (factory setting) and can be locked via the setup settings.

Proceed as follows to lock the device:

1. Press **E** to enter the configuration menu.
2. Press **+** repeatedly until **Setup** is displayed.
3. Press **E** to open the **Setup** menu.
4. Press **+** repeatedly until **Extended Setup** is displayed.

5. Press **E** to open the **Extended Setup** menu; **System** is displayed.
6. Press **E** to open the **System** menu.
7. Press **+** repeatedly until **Access code** is displayed.
8. Press **E** to open the setting for access protection.
9. Set the code: press the **+** and **-** buttons to set the desired code. The access code is a four-digit number. The corresponding position of the number is displayed in plain text. Press **E** to confirm the value entered and go to the next position.
10. Confirm the last position of the code to exit the menu. The full code is displayed. Press **+** to scroll back to the last item of the **x Back** submenu and confirm this item. By confirming the point, the value is adopted and the display returns to the **Setup** level. Again select the last parameter **x Back** to also exit this submenu and return to the measured value/channel display level.

Once access protection has been successfully activated, the lock symbol appears on the display.

-  Access to the calibration function can also be blocked by a code. The same procedure is required here as for locking the setup. To activate it, however, press **+** repeatedly in step 7 until **Calib Code** is displayed.
-  The **x Back** item at the end of every picklist/menu item takes the user from the submenu to the next menu level up.
-  If access protection is enabled, the device locks automatically after 600 seconds without operation. The display switches back to the operating display.
-  To enable the setup, set the setup access code in the **System Setup** to **0000** or delete the code by pressing **C**.
-  If you lose/misplace the code, a reset can only be performed by the Service Department.

6.4 Configuration of the device (Setup menu)

You can access the main menu by pressing the 'E' key during operation. Navigate through the available menus with the '+' and '-' keys. When the desired menu is displayed, press the 'E' key to open the menu. Use the 'x Back' option, which can be found at the bottom of each menu/submenu, to move up one level in the menu structure.

The Setup menu contains the most important settings for the operation of the device.

Parameters	Possible settings	Description
Current range	4-20 mA 0-20 mA	Configuration of the measuring range for the current output.
Out 1 0/4 mA	Numerical value 0.000 to 99 999 0.0 pH	Physical value which corresponds to the lower range limit of the analog output. When the configured value is undershot, the current output is set to the saturation current of 0/3.8 mA.

Parameters	Possible settings	Description
Out 1 20 mA	Numerical value 0.000 to 99 999 12 pH	Physical value which corresponds to the upper range limit of the analog output. When the configured value is exceeded, the current output is set to the saturation current of 20.5 mA.
Out 2 0/4 mA	Numerical value -50 to 250 °C 0 °C	Temperature which corresponds to the measuring range lower limit of the temperature input. When the configured value is undershot, the current output is set to the saturation current of 0/3.8 mA.
Out 2 20 mA	Numerical value -50 to 250 °C 100 °C	Temperature which corresponds to the measuring range upper limit of the temperature input. When the configured value is exceeded, the current output is set to the saturation current of 20.5 mA.
Damping main	0 to 60 s 0 s	Configuration of the damping for low-pass filtering of the input signals.
Extended setup		Advanced settings for the device, such as the relay, limit values etc. The functions are described in the following section, →  19.
Manual hold	Off, On	Function for freezing the current and relay outputs

6.5 Extended configuration (Extended setup menu)

You can access the main menu by pressing the 'E' key during operation. Use the '+' key to navigate to the Setup menu. Press the 'E' key to open the menu. Navigate to the Extended Setup menu and open the menu by pressing the 'E' key. Use the "x Back" option, which can be found at the bottom of each menu/submenu, to move up one level in the menu structure.

Parameters	Possible settings	Description
System		General settings
Device tag	Customized text Max. 16 characters	Use this function to enter the device tag.
Temp. unit	°C °F	Setting for the temperature unit
Hold release	0 to 600 s 0 s	Sets the time by which a device hold is extended after the hold condition is discontinued.
Alarm delay	0 to 600 s 0 s	Delay time for outputting an alarm. This suppresses alarm conditions that are present for a period that is shorter than the alarm delay time.

Parameters		Possible settings	Description
	Access code	0000 to 9999 Default: 0000	User code to protect the device configuration. Additional information: 0000 = user code protection is disabled
	Calib Code	0000 to 9999 Default: 0000	User code to protect the calibration function. Additional information: 0000 = user code protection is disabled
Input			Input settings
	Main value	pH mV	Unit of the physical value.
	Format	None (pH only) One Two	Number of places after decimal point for the display.
	Damping main	0 to 60 s 0 s	Configuration of the damping for low-pass filtering of the input signals.
	Temp. comp.	Off Automatic Manual	Configuration of the temperature compensation. Only visible for Main value = pH
	Temp. offset	Numerical value: -50 to 250 °C 0 °C	Configuration of a temperature offset. Only visible for Main value = mV
	Ref. temp.	Numerical value: -5.0 to 100 °C 25 °C	Configuration of the reference temperature. Only visible for Main value = pH and Temp. comp. = Manual .
Calib. settings			Settings for calibration
	Buffer 1	2.00 pH 4.00 pH 7.00 pH 9.00 pH 9.18 pH 10.00 pH 12.00 pH	pH value of buffer solution 1. Only visible for Main value = pH
	Buffer 2	2.00 pH 4.00 pH 7.00 pH 9.00 pH 9.18 pH 10.00 pH 12.00 pH	pH value of buffer solution 2. Only visible for Main value = pH
	Buffer mV	Numerical value 100 mV	mV value for buffer solution. Only visible for Main value = mV
Stability crit.			
	Delta mV	1 to 10 mV 1 mV	
	Duration	10 to 60 s 20 s	

Parameters		Possible settings	Description
	Process check		Checks the process settings
	Function	On, Off	Switch on the process check.
	Inactive time	1 to 240 min 60 min	Duration of the process check
Analog outputs			Settings for analog outputs
	Current range	4-20 mA 0-20 mA	Current range for analog output
	Out 1 0/4 mA	Numerical value 0.000 - 99999 0.0 pH	Physical value which corresponds to the lower range limit of the analog output.
	Out 1 20 mA	Numerical value 0.000 - 99999 12 pH	Physical value which corresponds to the upper range limit of the analog output.
	Out 2 0/4 mA	Numerical value -50 to 250 °C 0 °C	Temperature which corresponds to the measuring range lower limit of the temperature input.
	Out 2 20 mA	Numerical value -50 to 250 °C 100 °C	Temperature which corresponds to the measuring range upper limit of the temperature input.
	Damping main value	0 to 60 s 0 s	Configuration of the damping for low-pass filtering of the input signals.
Relay 1/2			Settings for the relay outputs.
	Function	Off , Min limit, Max limit, In band, Out band, Error	Configuration of the relay function. If Function = Error , no additional settings are possible.
	Assignment	Main , Temp	Assignment of the relay to the main input or temperature input
	Set point	Numerical value 0.0	Setting for the limit value.
	Set point 2	Numerical value 0.0	Only for the In band or Out band function.
	Hyst.	Numerical value 0.0	Configuration of the hysteresis.
	Delay time	0 to 60 s 0 s	Configuration of the delay time until the relay switches.
Factory default			Resets the device settings to the factory default settings.
	Please confirm	no , yes	Confirm the reset.

6.5.1 Configuration of the relays

The device has two relays with limit values that are either switched off or can be allocated to the input signal. The limit value is entered as a numerical value including the decimal position. The operating mode of the relays as normally open or normally closed is determined by the wiring of the changeover contact (→  36). Limit values are always assigned to a relay. Each relay can be assigned to a channel or a calculated value. In the "Error" mode, the relay functions as an alarm relay and switches each time a fault or alarm occurs.

The following settings can be made for each of the 2 limit values: assignment, limit, hysteresis, switching behavior, delay and failure mode.

6.6 Device diagnostics (Diagnostics menu)

You can access the main menu by pressing the 'E' key during operation. Navigate through the available menus with the '+' and '-' keys. When the desired menu is displayed, press the 'E' key to open the menu. Use the "x Back" option, which can be found at the bottom of each menu/submenu, to move up one level in the menu structure.

Parameters		Possible settings	Description
Current diag.		Read only.	Displays the current diagnostic message
Last diag.		Read only.	Displays the last diagnostic message
Diagnost logbook		Read only	Displays the last diagnostic messages
Device info		Read only.	Displays the device information
	Device tag	Read only.	Displays the device tag
	Device name	Read only.	Displays the device name
	Serial number	Read only.	Displays the serial number of the device
	Order ident	Read only.	Displays the order code of the device
	FW revision	Read only.	Displays the firmware version
	ENP version	Read only.	Displays the version of the electronic nameplate
	Module ID	Read only.	Displays the module ID
	Manufact. ID	Read only.	Displays the manufacturer ID
	Manufact. name	Read only.	Displays the manufacturer name

7 Calibration and adjustment

7.1 Definitions

7.1.1 Calibration (as per DIN 1319):

Determining the relationship between the measured or expected value of the output variable and the corresponding true or correct value of the measured variable (input variable) for a measuring device under specified conditions.

During calibration, there is no intervention that changes the measuring instrument.

7.1.2 Adjustment

An adjustment corrects the value displayed by a measuring device, in other words the measured/displayed value (the actual value) is corrected so that the reading agrees with the correct, set value.

The value determined during calibration is used to calculate the correct measured value and saved in the sensor.

7.2 pH sensors

The pH value is calculated using the Nernst equation

$\text{pH} = -\lg(a_{\text{H}^+})$, a_{H^+} ... activity of the hydrogen ions

U_i ... raw measured value in mV

U_0 ... zero point (=voltage at pH 7)

R ... relative gas constant (8.3143 J/molK)

T ... temperature [K]

F ... Faraday constant (26.803 Ah)

The slope of the Nernst equation ($-2.303 RT/F$) is known as the **Nernst factor** and is -59.16 mV/pH at $25 \text{ }^\circ\text{C}$ ($77 \text{ }^\circ\text{F}$).

The smaller the slope, the less sensitive the measurement, and the accuracy deteriorates particularly in the low measuring range.

The calibration provides important information on the condition of your sensor and the quality of the pH measurement.

The service life of a pH glass electrode is limited. One of the reasons for this is the deterioration and aging of the pH-sensitive membrane glass. This aging causes the gel-like layer to change and become thicker over time.

Symptoms of aging include:

- Higher membrane resistance
- Slow response
- Decrease in the slope

To ensure a high level of accuracy, it is important to readjust the pH sensors at set intervals.

The calibration interval depends heavily on the area of application of the sensor, as well as the required level of accuracy and reproducibility. The calibration interval can vary between weekly and once every few months.

Two-point calibration is the preferred method for pH sensors, particularly in the following applications:

- Municipal and industrial wastewater
- Natural waters and drinking water
- Boiler feedwater and condensates
- Beverages

Calibrating with buffers with pH 7.0 and 4.0 is recommended for most applications.

You use calibration buffers to perform two-point calibration. The quality buffers supplied by Endress+Hauser are certified and measured in an accredited laboratory. The accreditation (DAR registration number "DKD-K-52701") confirms that the actual values and the maximum deviations are correct and traceable.

To calibrate the sensor, remove it from the medium and calibrate it in the laboratory. Since Memosens sensors save the data, you can always work with "precalibrated" sensors and do not have to stop monitoring the process to perform a calibration.

Calibration of a pH glass electrode:

1. Press "E" to call up the main menu.
2. Press the "+" button to navigate to the "Calibration" menu.
3. Press "E" to open the menu.
 - ↳ Display reads "pH glass".
4. Press "E" to open the menu.
 - ↳ Display reads "pH (act)".
5. Press "+".
 - ↳ Display reads "Insert sensor".
6. Remove the glass electrode from buffer 1, rinse with distilled water, dry and immerse in buffer 2.
7. Press "+".
8. Display reads "wait for stable value", when the value is stable, the display changes.
 - ↳ Display for buffer 2 value, "pH Buffer 2".
9. Press "+".
 - ↳ Display reads "Save Calib. Data?"
10. Press "+".
 - ↳ Display reads "Calib. successful".
11. Press "+".

Return to measuring operation

The calibration is not completed successfully or is canceled and is not valid.

Possible reasons:

- The sensor is old or contaminated. As a result, the permitted limit values for the slope and/or zero point are exceeded.
 - Clean the sensor
 - Regenerate or replace the sensor
- The measured value or temperature is not stable. As a result, the stability criterion is not met.
 - Keep the temperature constant during calibration.
 - Replace the buffer.
 - The sensor is old or contaminated. Clean or regenerate.



To calibrate the sensor, you can also remove it from the medium and calibrate it in the laboratory. Since Memosens sensors save the data, you can always work with "precalibrated" sensors and do not have to stop monitoring the process to perform a calibration.

7.3 ORP sensors

7.3.1 Single-point calibration

The buffers contain ORP pairs with a high exchange current density. Such buffers have the advantage of higher accuracy levels, better reproducibility and faster measurement response times.

Temperature compensation does not take place when measuring the ORP since the thermal behavior of the medium is not known. The temperature is indicated with the measurement result, however.

With this type of calibration, you work with calibration buffers, e.g. ORP buffers from Endress+Hauser.

Calibration of an ORP sensor

1. Press "E" to call up the main menu.
2. Press the "+" button to navigate to the "Calibration" menu.
3. Press "E" to open the menu.
 - ↳ Display reads "mV (act)".
4. Remove the ORP electrode from the measurement medium, flush with distilled water, dry it and immerse it in the ORP buffer.
5. Press "+".
 - ↳ Display reads "Insert sensor in med."
6. Press "+".
 - ↳ Display reads "wait for stable value".
7. The current status of the ORP buffer appears on the display.
8. Press "+".
 - ↳ Display reads "Save Calib. Data?"

9. Press "E" and select "yes" to confirm.
10. Remove the sensor from the measurement medium, flush with distilled water, dry it and place it back into the measurement medium.

 To calibrate the ORP sensors, you can also remove them from the medium and calibrate them in the laboratory.

Since Memosens sensors save the data, you can always work with "precalibrated" sensors and do not have to stop monitoring the process for extended periods to perform a calibration.

7.4 Device functions for calibration

Press the 'E' button during operation to call up the main menu. Use the '+' and '-' buttons to navigate through the available menus. When the desired menu is displayed, press the 'E' key to open the menu. Select the "x Back" option at the end of each menu/submenu to navigate one level higher in the menu structure.

Parameter		Configuration options	Description
pH glass			Calibrate the pH measurement.
	Calib. start	Read only	
	pH act.	Read only	Displays the current pH value
	pH Buffer 1	Numerical value pH	Displays the buffer value measured
	pH Buffer 2	Numerical value pH	Displays the buffer value measured
	Save calib data?	Yes, No	Save or discard calibration data?
Temperature			Calibrate the temperature measurement.
	T cal. start	Read only	
	T cal.	Numerical value	
	Save calib data?	Yes, No	Save or discard calibration data?

8 Maintenance

No special maintenance work is required on the device.

9 Accessories

9.1 Sensors

Glass electrodes for pH measurement

Orbisint CPS11D

- pH electrode for process engineering, with dirt-repellent PTFE junction
- Memosens technology
- Order as per product structure, see Technical Information (TI00028C/07/en)

Orbipore CPS91D

- pH sensor with Memosens technology
- Open aperture junction for media with high dirt load
- Order depending on version, see Technical Information (TI00375C/07/en)

Orbipac CPF81D

- pH compact sensor for installation or immersion operation in industrial water and wastewater
- Order as per product structure, see Technical Information (TI00191C/07/EN)

ORP sensors

Orbisint CPS12D

- ORP sensor with Memosens technology
- Dirt-repellent PTFE junction
- Order depending on version, see Technical Information (TI00367C/07/en)

Orbipore CPS92D

- ORP sensor with Memosens technology
- Open aperture junction for media with high dirt load
- Order depending on version, see Technical Information (TI00435C/07/en)

Orbipac CPF82D

- ORP compact sensor for installation or immersion operation in industrial water and wastewater
- Order as per product structure, see Technical Information (TI00191C/07/EN)

10 Troubleshooting

To help you troubleshoot, the following section is designed to provide an overview of possible causes of errors and initial remedial measures.

10.1 Troubleshooting instructions



WARNING

Danger! Electric voltage!

► Do not operate the device in an open condition for error diagnosis!

User interface	Reason	Solution
No measured value displayed	No power supply connected	Check the power supply to the device.
	Power is supplied, device is defective	The device must be replaced.
Diagnostic message is displayed	The list of diagnostic messages is provided in the following section.	

10.2 Diagnostic messages

The diagnostic message consists of a diagnostic code and a message text.

The diagnostic code consists of the error category as per Namur NE 107 and the message number.

Error category (letter in front of the message number)

- **F = Failure**, a malfunction has been detected.
The measured value of the affected channel is no longer reliable. The cause of the malfunction is to be found in the measuring point. Any control system connected should be set to manual mode.
- **M = Maintenance required**, action should be taken as soon as possible.
The device still measures correctly. Immediate measures are not necessary. However, proper maintenance efforts would prevent a possible malfunction in the future.
- **C = Function check, queue (no error)**.
Maintenance work is being performed on the device. Wait until the work has been completed.
- **S = Out of specification**, the measuring point is being operated outside its specifications. Operation is still possible. However, you run the risk of increased wear, shorter operating life or lower measurement accuracy. The cause of the problem is to be found outside the measuring point.

Examples of how messages are displayed:

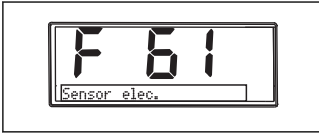

A0015896

F 61
sensor elec.



A0015897

M 915
USP warning

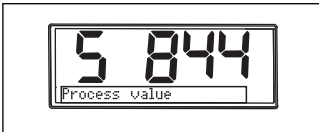

A0015898

S 844
Process value

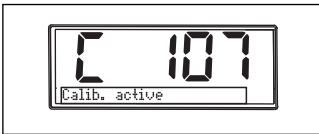

A0015899

C 107
Calib. active

Diagnostic code	Message text	Description
F5	Sensor data	Sensor data invalid. Remedy: <ul style="list-style-type: none"> ▪ Update the transmitter data ▪ Replace sensor
F12	Writing data	Not possible to write the sensor data. Remedy: <ul style="list-style-type: none"> ▪ Repeat writing the sensor data ▪ Replace sensor
F13	Sensor type	Incorrect sensor type. Remedy: Change to a sensor of the type that is configured.
F61	Sensor elec.	Sensor electronics defective. Remedy: <ul style="list-style-type: none"> ▪ Replace sensor ▪ Contact the Service Department
F62	Sens. Connect	Sensor connection. Remedy: <ul style="list-style-type: none"> ▪ Replace sensor ▪ Contact the Service Department

Diagnostic code	Message text	Description
F100	Sensor comm.	Sensor not communicating. Possible reasons: <ul style="list-style-type: none"> ▪ No sensor connection ▪ Incorrect sensor connection ▪ Short-circuit in sensor cable ▪ Short-circuit in adjacent channel ▪ Sensor firmware update interrupted incorrectly Remedy: <ul style="list-style-type: none"> ▪ Check sensor cable connection ▪ Check sensor cable for short-circuit ▪ Change sensor ▪ Restart the firmware update ▪ Contact the Service Department
F118	Glass crack	Sensor glass breakage alarm. Impedance of glass membrane too low. Remedy: <ul style="list-style-type: none"> ▪ Check glass electrode for breaks and hair-line cracks ▪ Check medium temperature ▪ Check the electrode plug-in head for moisture and dry if necessary ▪ Replace sensor
F120	Sensor ref.	Sensor reference alarm. Impedance of reference too low. Remedy: <ul style="list-style-type: none"> ▪ Check glass electrode for breaks and hair-line cracks ▪ Check medium temperature ▪ Check the electrode plug-in head for moisture and dry if necessary ▪ Replace sensor
F124	Sensor glass	Sensor glass limit value exceeded, alarm. Impedance of glass membrane too high. Remedy: <ul style="list-style-type: none"> ▪ Check pH sensor, replace if necessary ▪ Check glass limit value, correct if necessary ▪ Replace sensor
F142	Sensor signal	Sensor check. No conductivity displayed. Possible reasons: <ul style="list-style-type: none"> ▪ Sensor in air ▪ Sensor defective Remedy: <ul style="list-style-type: none"> ▪ Check sensor installation ▪ Replace sensor
F143	Self-test	Sensor self-test error. Remedy: <ul style="list-style-type: none"> ▪ Replace sensor ▪ Contact the Service Department
F845	Device id	Incorrect hardware configuration

Diagnostic code	Message text	Description
F846	Param error	Incorrect parameter checksum Possible cause: Firmware update Remedy: Reset parameter to factory defaults
F847	Couldn't save param	The parameters could not be saved
F848	Calib AO1	Incorrect calibration values for analog output 1
F849	Calib AO2	Incorrect calibration values for analog output 2
F904	Process check	Process check system alarm. Measuring signal has not changed for a long time. Possible reasons <ul style="list-style-type: none"> ▪ Contaminated sensor, or sensor in air ▪ No flow to sensor ▪ Sensor defective ▪ Software error Remedy: <ul style="list-style-type: none"> ▪ Check electrode system ▪ Check sensor ▪ Restart the software

Diagnostic code	Message text	Description
C107	Calib. active	Sensor calibration is active. Remedy: Wait for calibration to be finished
C154	No calib. data	Sensor data. No calibration data available, factory settings are used. Remedy: <ul style="list-style-type: none"> ▪ Check the calibration information of the sensor ▪ Calibrating the cell constant
C850	Simu AO1	Simulation of analog output 1 is active
C851	Simu AO2	Simulation of analog output 2 is active
C853	Download act.	Parameter transmission is active

Diagnostic code	Message text	Description
S844	Process value	<p>Measured value outside the specified range. Measured value outside the specified range</p> <p>Possible reasons:</p> <ul style="list-style-type: none"> ▪ Sensor in air ▪ Air pockets in the assembly ▪ Incorrect flow to sensor ▪ Sensor defective <p>Remedy:</p> <ul style="list-style-type: none"> ▪ Increase process value ▪ Check electrode system ▪ Change sensor type
S910	Limit switch	Limit switch activated

Diagnostic code	Message text	Description
M126	Sensor check	<p>Check the sensor. Poor condition of electrode.</p> <p>Possible reasons:</p> <ul style="list-style-type: none"> ▪ Glass membrane blocked or dry ▪ Diaphragm blocked <p>Remedy:</p> <ul style="list-style-type: none"> ▪ Clean sensor, regenerate ▪ Replace sensor
M500	Not stable	<p>Sensor calibration aborted. Main measured value fluctuating.</p> <p>Possible reasons:</p> <ul style="list-style-type: none"> ▪ Sensor aging ▪ Sensor periodically dry ▪ Buffer value not constant <p>Remedy:</p> <ul style="list-style-type: none"> ▪ Check sensor, replace if necessary ▪ Check buffer

10.3 Firmware history

Revision history

The firmware version (FW) on the nameplate and in the Operating Instructions indicates the device release: XX.YY.ZZ (example 01.02.01).

XX Change to main version. No longer compatible. The device and Operating Instructions change.

YY Change to functions and operation. Compatible. The Operating Instructions change.

ZZ Fixes and internal changes. No changes to the Operating Instructions.

Date	Firmware Version	Changes	Documentation
09/2011	01.01.ZZ	Original firmware	BA01032C/09/en/01.11
06/2014	02.00.ZZ	Limit values for sensors changed	BA01032C/09/en/02.14
11/2019	02.01.ZZ	Password protection for users amended	BA01032C/09/en/03.19

10.4 Spare parts

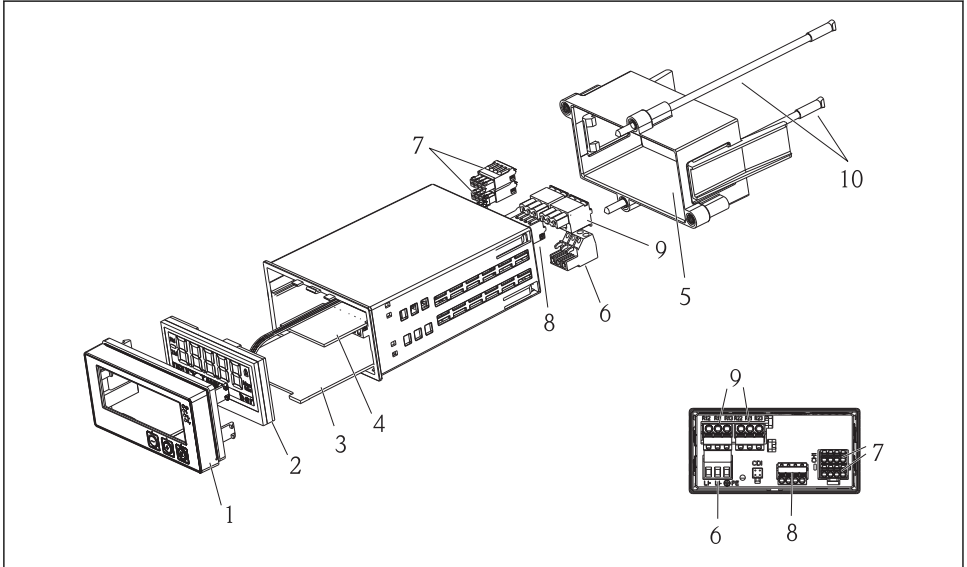

A0015745

5 Spare parts of the device

Item no.	Description	Order no.
1	Housing front + foil, incl. keyboard CM14, without display	XPM0004-DA
2	CPU/Display board CM14 pH, ORP (glass)	XPM0004-CM
3	Mainboard 24-230VDC/AC, CM14	XPM0004-NA
4	Relay board + 2 limit relays	RIA45X-RA
5	Fixing frame for housing W07	71069917
6	Terminal, 3-pole (power supply)	50078843
7	Pluggable terminal, 4-pole (Memosens input)	71037350
8	Pluggable terminal, 4-pole (current output)	71075062
9	Pluggable terminal, 3-pole (relay terminal)	71037408
10	Threaded bar for tube fixing clip 105mm	71081257

10.5 Return

For a return, e.g. in case of repair, the device must be sent in protective packaging. The original packaging offers the best protection. Repairs must only be carried out by your supplier's service organization.



When sending for repair, please enclose a note with a description of the error and the application.

10.6 Disposal

The device contains electronic components and must, therefore, be disposed of as electronic waste in the event of disposal. Please pay particular attention to the local regulations governing waste disposal in your country.

11 Technical data

11.1 Input

11.1.1 Measured variables

--> Documentation of the connected sensor

11.1.2 Measuring ranges

--> Documentation of the connected sensor

11.1.3 Input types

Digital sensor inputs, Memosens and Memosens protocol

11.1.4 Cable specification

Cable type

Memosens data cable or fixed sensor cable, each with cable end sleeves

Cable length

Max. 100 m (330 ft)

11.2 Output

11.2.1 Output signal

2 x 0/4 to 20 mA active, potentially isolated from the sensor circuits and from each other

11.2.2 Load

Max. 500 Ω

11.2.3 Linearization/transmission behavior

Linear

11.2.4 Alarm output

The alarm output is designed as an "open collector." In normal operation the alarm output is closed. In the event of a fault (F-fault, device without current) the "open collector" opens.

Current max.	200 mA
Voltage max.	30 V DC

11.3 Current outputs, active

11.3.1 Span

0 to 23 mA

11.3.2 Signal characterization

Linear

11.3.3 Electrical specification

Output voltage

Max. 24 V

11.3.4 Cable specification

Cable type

Recommendation: shielded line

Cross-section

Max. 1.5 mm² (16 AWG)

11.4 Relay outputs

11.4.1 Relay types

2 changeover contacts

11.4.2 Relay switching capacity

Max. 3 A24 V DC

Max. 3 A253 V AC

Min. 100 mW (5 V / 10 mA)

11.4.3 Cable specification

Cross-section

Max. 2.5 mm² (14 AWG)

11.5 Wiring

11.5.1 Electrical connection

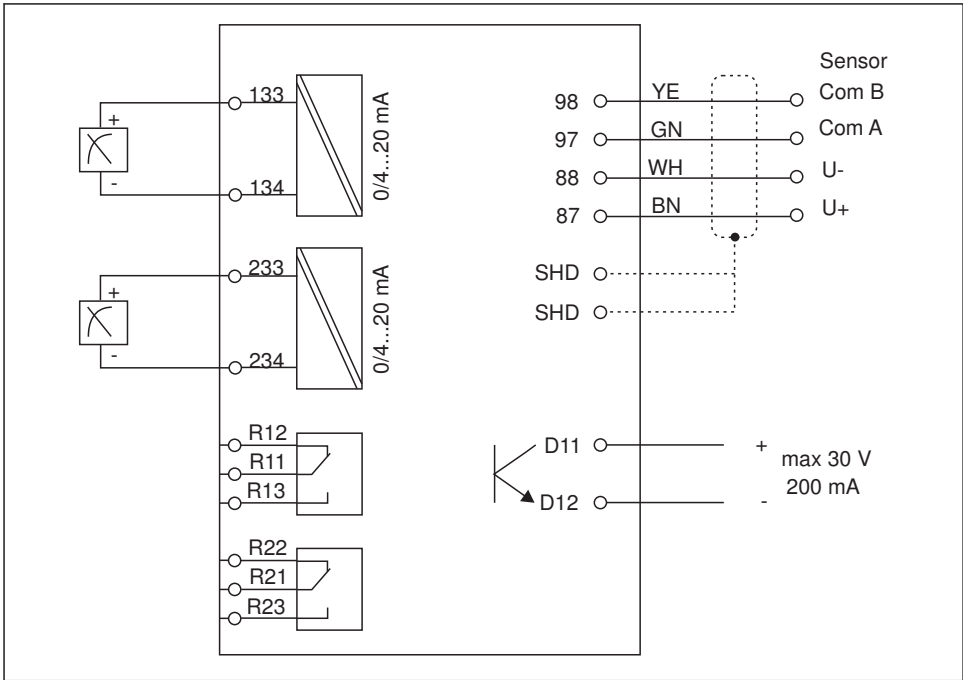

A0015303

Connection	Description
87	Terminal for Memosens cable, brown, sensor power supply U+
88	Terminal for Memosens cable, white, sensor power supply U-
97	Terminal for Memosens cable, green, Com A
98	Terminal for Memosens cable, yellow, Com B
SHD	Terminal for Memosens cable, shield
D11	Terminal for alarm output, +
D12	Terminal for alarm output, -
L/+	Terminal for transmitter supply voltage
N/-	
⊕ PE	
133	Terminal for analog output 1, +

Connection	Description
134	Terminal for analog output 1, -
233	Terminal for analog output 2, +
234	Terminal for analog output 2, -
R11, R12, R13	Terminal for relay 1
R21, R22, R23	Terminal for relay 2

11.5.2 Supply voltage

Wide range power unit 24 to 230 V AC/DC (-20 % / +10 %) 50/60Hz



The device does not have a power switch

- The customer must provide a protected circuit breaker in the vicinity of the device.
- The circuit breaker must be a switch or power switch, and must be labeled as the circuit breaker for the device.

11.5.3 Power consumption

Max. 13.8 VA / 6.6 W

11.6 Performance characteristics

11.6.1 Response time

Current outputs

t_{90} = max. 500 ms for a jump from 0 to 20 mA

11.6.2 Reference temperature

25 °C (77 °F)

11.6.3 Maximum measured error of inputs

--> Documentation of the connected sensor

11.6.4 Resolution of current output

> 13 bit

11.6.5 Repeatability

--> Documentation of the connected sensor

11.7 Mounting conditions

11.7.1 Installation instructions

Mounting location

Panel, cutout 92 x 45 mm (3.62 x 1.77 in)

Max. panel thickness 26 mm (1 in)

Installation position

The orientation is determined by the legibility of the display.

Max. viewing angle range of +/- 45° from the central display axis in every direction.

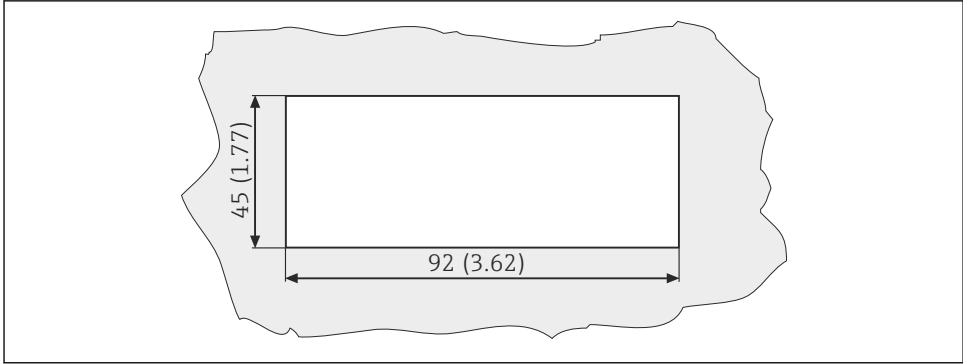

A0010351

6 Panel cutout, dimensions in mm (in)

11.8 Environment

11.8.1 Ambient temperature range

-10 to +60 °C (14 to 140 °F)

11.8.2 Storage temperature

-40 to +85 °C (-40 to +185 °F)

11.8.3 Operating height

< 2 000 m (6 561 ft) above MSL

11.8.4 Electromagnetic compatibility

Emitted interference and interference immunity to EN 61326-1:2006, Class A for industrial areas

11.8.5 Degree of protection

Front

Front IP65 / NEMA 4X

Tube

Shock protection IP20

11.8.6 Relative humidity

5 to 85 %, non-condensing

11.9 Mechanical construction

11.9.1 Dimensions

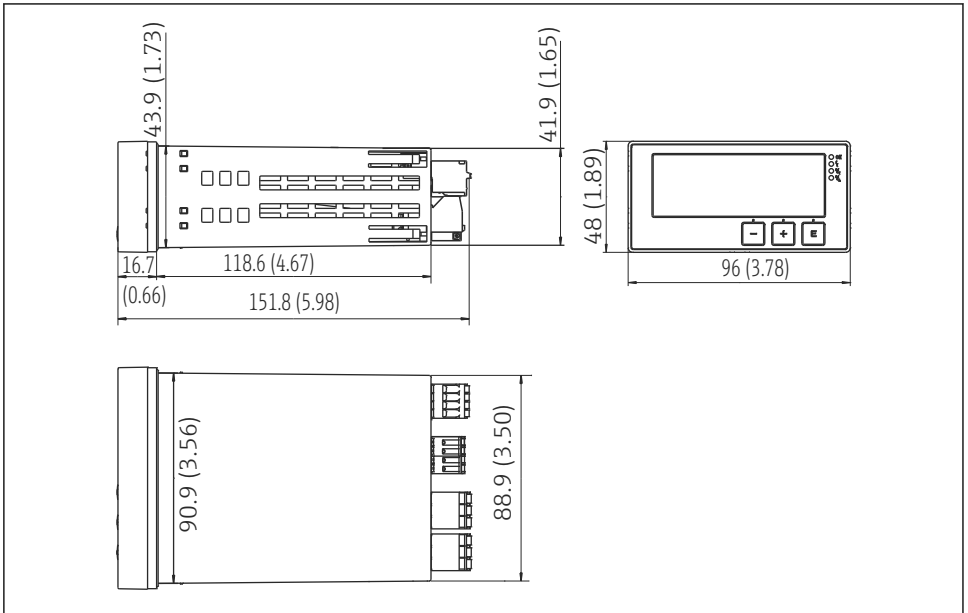

A0015925

7 Dimensions of the transmitter in mm (in)

11.9.2 Weight

0.3 kg (0.66 lbs)

11.9.3 Materials

Housing, casing:	Polycarbonate
Front foil:	Polyester, UV-resistant

11.9.4 Terminals

Max. 2.5 mm² (22-14 AWG; tightening torque 0.4 Nm (3.5 lb in)) line, relay

11.10 Display and operating elements

11.10.1 Operating elements

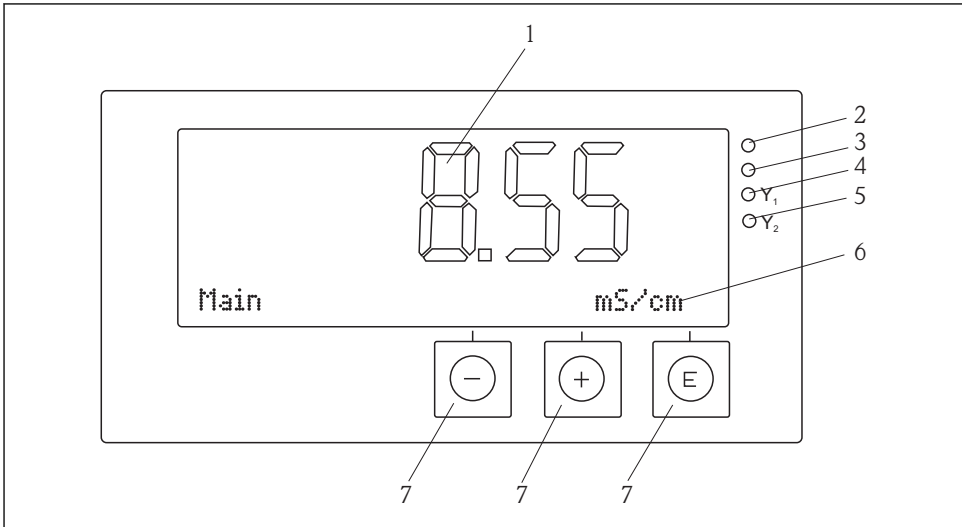

A0018699

8 Display and operating elements

- 1 LC display for displaying the measured values and configuration data
- 2 Status LED, power supply connected
- 3 Status LED, alarm function
- 4 Status LED for limit switch relay 1
- 5 Status LED for limit switch relay 2
- 6 Dot matrix display for displaying the dimensions and menu items
- 7 Operating keys

11.11 Certificates and approvals

11.11.1 CE mark

Declaration of Conformity

The product fulfills the requirements of harmonized European standards.

Thus it fulfills the legal requirements of the EC Directives.

The manufacturer confirms successful testing of the device by affixing to it the CE mark.

Other standards and guidelines

- IEC 60529:
Degree of protection by housing (IP code)
- IEC 61010-1: 2001 Cor 2003
Safety requirements for electrical equipment for measurement, control and laboratory use

Index

C

Calibration	
ORP sensors	25
pH sensors	23
CE mark	8

D

Device configuration	
Setup access protection	17
Diagnostic messages	28
Display symbols	15

E

Error messages	28
--------------------------	----

I

Icons	
Display	15
Editing mode	15

O

Operational safety	4
------------------------------	---

R

Relay	22
-----------------	----

S

Staff	
Requirements	4

U

Unsuccessful calibration	25
------------------------------------	----

W

Workplace safety	4
----------------------------	---

www.addresses.endress.com
