

# Operating Instructions

## Memosens CLS82E





Hygienic conductivity sensor  
Digital with Memosens technology











# 1 About this document

## 1.1 Warnings

Structure of information	Meaning
<p> <b>DANGER</b></p> <p><b>Causes (/consequences)</b>                      If necessary, Consequences of non-compliance (if applicable)                      ► Corrective action</p>	<p>This symbol alerts you to a dangerous situation.                      Failure to avoid the dangerous situation <b>will</b> result in a fatal or serious injury.</p>
<p> <b>WARNING</b></p> <p><b>Causes (/consequences)</b>                      If necessary, Consequences of non-compliance (if applicable)                      ► Corrective action</p>	<p>This symbol alerts you to a dangerous situation.                      Failure to avoid the dangerous situation <b>can</b> result in a fatal or serious injury.</p>
<p> <b>CAUTION</b></p> <p><b>Causes (/consequences)</b>                      If necessary, Consequences of non-compliance (if applicable)                      ► Corrective action</p>	<p>This symbol alerts you to a dangerous situation.                      Failure to avoid this situation can result in minor or more serious injuries.</p>
<p> <b>NOTICE</b></p> <p><b>Cause/situation</b>                      If necessary, Consequences of non-compliance (if applicable)                      ► Action/note</p>	<p>This symbol alerts you to situations which may result in damage to property.</p>

## 1.2 Symbols

-  Additional information, tips
-  Permitted or recommended
-  Not permitted or not recommended
-  Reference to device documentation
-  Reference to page
-  Reference to graphic
-  Result of a step

## 1.3 Documentation

 Technical Information Memosens CLS82E, TI01529C

 Special Documentation for hygienic applications, SD02751C

In addition to these Operating Instructions, an XA with "Safety instructions for electrical apparatus in the hazardous area" is also included with sensors for use in the hazardous area.

- Please follow instructions on use in the hazardous area carefully.

## 2 Basic safety instructions

### 2.1 Requirements for the personnel

- Installation, commissioning, operation and maintenance of the measuring system may be carried out only by specially trained technical personnel.
- The technical personnel must be authorized by the plant operator to carry out the specified activities.
- The electrical connection may be performed only by an electrical technician.
- The technical personnel must have read and understood these Operating Instructions and must follow the instructions contained therein.
- Faults at the measuring point may only be rectified by authorized and specially trained personnel.



Repairs not described in the Operating Instructions provided must be carried out only directly at the manufacturer's site or by the service organization.

### 2.2 Intended use

The Memosens CLS82E conductivity sensor is used to measure low to high conductivity of liquids in applications with hygienic requirements.

**The broad measuring range means the device can be used in a large number of applications, e.g. :**

- Phase separation of water/product mixtures
- Phase separation of product/product mixtures
- Monitoring of rinsing processes
- Fermentations
- Monitoring of water bodies
- Concentration measurement of bases and acids (consider the material resistance properties!)
- Monitoring product quality

The digital sensor is used with the Liquiline CM44x or Liquiline CM42.

Use of the device for any purpose other than that described, poses a threat to the safety of people and of the entire measuring system and is therefore not permitted.

The manufacturer is not liable for damage caused by improper or non-designated use.

### 2.3 Workplace safety

As the user, you are responsible for complying with the following safety conditions:

- Installation guidelines
- Local standards and regulations
- Regulations for explosion protection

#### **Electromagnetic compatibility**

- The product has been tested for electromagnetic compatibility in accordance with the applicable international standards for industrial applications.
- The electromagnetic compatibility indicated applies only to a product that has been connected in accordance with these Operating Instructions.

## 2.4 Operational safety

### Before commissioning the entire measuring point:

1. Verify that all connections are correct.
2. Ensure that electrical cables and hose connections are undamaged.
3. Do not operate damaged products, and protect them against unintentional operation.
4. Label damaged products as defective.

### During operation:

- ▶ If faults cannot be rectified:  
products must be taken out of service and protected against unintentional operation.

## 2.5 Product safety

The product is designed to meet state-of-the-art safety requirements, has been tested, and left the factory in a condition in which it is safe to operate. The relevant regulations and international standards have been observed.

# 3 Incoming acceptance and product identification

## 3.1 Incoming acceptance

1. Verify that the packaging is undamaged.
  - ↳ Notify the supplier of any damage to the packaging.  
Keep the damaged packaging until the issue has been resolved.
2. Verify that the contents are undamaged.
  - ↳ Notify the supplier of any damage to the delivery contents.  
Keep the damaged goods until the issue has been resolved.
3. Check that the delivery is complete and nothing is missing.
  - ↳ Compare the shipping documents with your order.
4. Pack the product for storage and transportation in such a way that it is protected against impact and moisture.
  - ↳ The original packaging offers the best protection.  
Make sure to comply with the permitted ambient conditions.

If you have any questions, please contact your supplier or your local Sales Center.

## 3.2 Product identification

### 3.2.1 Nameplate

The nameplate provides you with the following information on your device:

- Manufacturer identification
- Extended order code
- Serial number
- Safety information and warnings

► Compare the information on the nameplate with the order.

### 3.2.2 Product identification

#### Product page

[www.endress.com/cls82e](http://www.endress.com/cls82e)

#### Interpreting the order code

The order code and serial number of your product can be found in the following locations:

- On the nameplate
- In the delivery papers

#### Obtaining information on the product

1. Open [www.endress.com](http://www.endress.com).
2. Call up the site search (magnifying glass).
3. Enter a valid serial number.
4. Search.
  - ↳ The product structure is displayed in a popup window.
5. Click on the product image in the popup window.
  - ↳ A new window (**Device Viewer**) opens. All of the information relating to your device is displayed in this window as well as the product documentation.

#### Manufacturer address

Endress+Hauser Conducta GmbH+Co. KG  
Dieselstraße 24  
D-70839 Gerlingen

## 3.3 Scope of delivery

The scope of delivery includes:

- Sensor in the version ordered
- Operating Instructions

## 4 Mounting

### 4.1 Mounting requirements

#### 4.1.1 Hygiene-compliant installation



- ▶ The use of an EHEDG-certified assembly is a prerequisite for the easy-to-clean installation of a 12-mm sensor in accordance with EHEDG requirements.
- ▶ Furthermore, the instructions regarding the hygienic installation and operation of the assembly in the relevant Operating Instructions must be adhered to.
- ▶ Easily cleanable installation of equipment according to the criteria of the EHEDG must be free of dead legs.
- ▶ If a dead leg is unavoidable, it shall be kept as short as possible. Under no circumstances shall the length of a dead leg  $L$  exceed the pipe's inner diameter  $D$  minus the equipment's enveloping diameter  $d$ . The condition  $L \leq D - d$  applies.
- ▶ Furthermore, the dead leg must be self-draining, so neither product nor process fluids are retained therein.
- ▶ Within tank installations, the cleaning device must be located so that it directly flushes the dead leg.
- ▶ For further reference, see the recommendations concerning hygienic seals and installations in EHEDG Doc. 10 and the Position Paper: "Easy cleanable Pipe couplings and Process connections".

For 3-A-compliant installation, please observe the following:

- ▶ After the device has been mounted, hygienic integrity must be guaranteed.
- ▶ 3-A-compliant process connections must be used.

#### 4.1.2 Installation factors for assemblies



For flow assemblies or assemblies with a basket protector where it is not possible to maintain a distance  $a > 15$  mm ( $\rightarrow$   1,  8) to the sensor element, it is advisable to determine the installation factor by calibrating in the assembly used in order to guarantee the specified sensor measured error.

- ▶ Prior to installation:  
Remove the black protective cap from the sensor element.

Symmetrical installation is recommended in order to guarantee linearity. The distance to the side walls and opposite walls must be at least 15 mm.

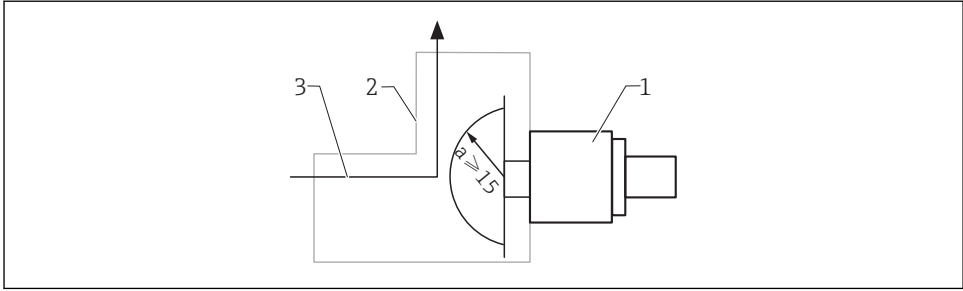

A0024621

☑ 1 Minimum distance between pipe and end of the measuring cell

1 Sensor

2 Pipe

3 Direction of flow

The ionic current in the liquid is affected by the walls in confined installation conditions. This effect is compensated by what is referred to as the installation factor. The installation factor can be entered in the transmitter for the measurement or the cell constant is corrected by multiplying by the installation factor.

The value of the installation factor depends on the diameter and the conductivity of the pipe nozzle as well as the sensor's distance to the wall. The installation factor can be disregarded ( $f = 1.00$ ) if the distance to the wall is sufficient ( $a > 15$  mm). If the distance to the wall is smaller, the installation factor increases for electrically insulating pipes ( $f > 1$ ) and decreases for electrically conductive pipes ( $f < 1$ ). The installation factor can be determined using calibration solutions.

- ▶ Ensure that the electrodes are fully immersed in the medium during measurement. Ideally, medium should flow to the measuring cell from the front.
  - ↳ Any other installation position can cause air pockets to occur or the buildup of solid impurities.



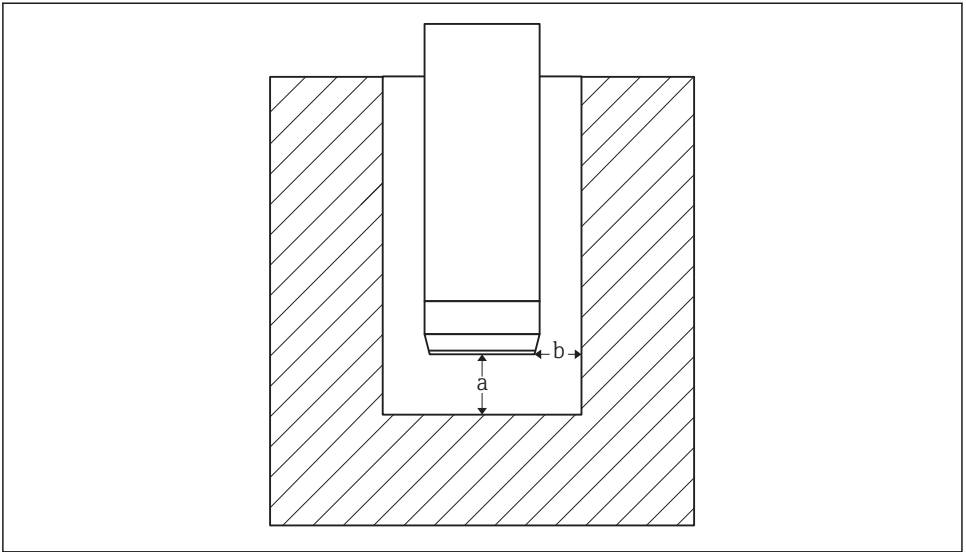

A0024626

2 Schematic drawing of the sensor in confined installation conditions

- a Wall distance
- b Gap width

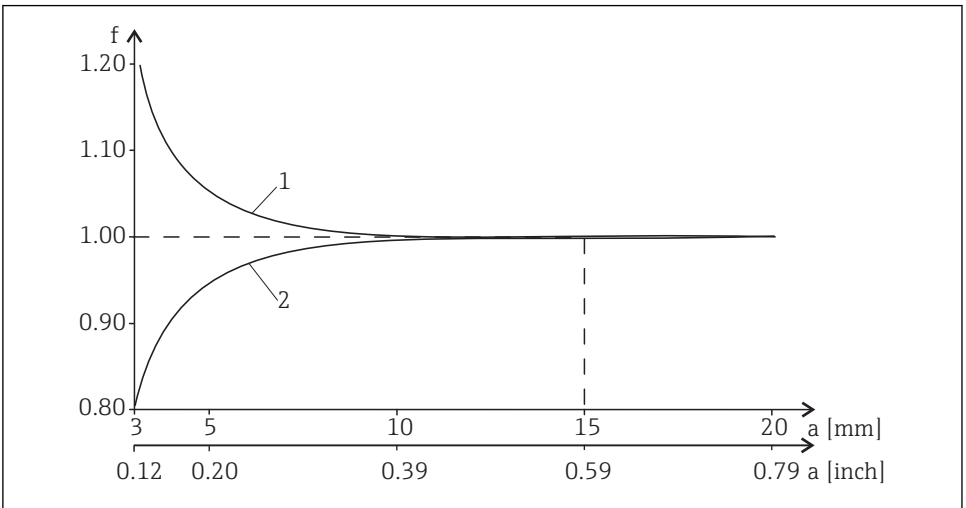

A0034378

3 Relationship between installation factor  $f$  and wall distance  $a$

- 1 Electrically insulating pipe wall
- 2 Electrically conductive pipe wall

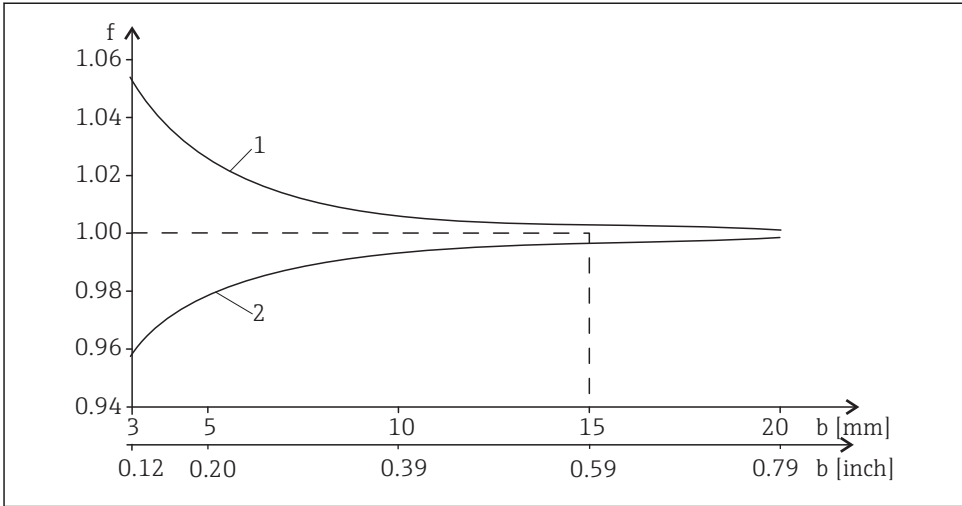

A0024616

4 Relationship between installation factor  $f$  and gap width  $b$

- 1 Electrically insulating pipe wall
- 2 Electrically conductive pipe wall

## 4.2 Post-mounting check

1. Are the sensor and cable undamaged?
2. Is the sensor installed in the process connection and is not suspended from the cable?

## 5 Electrical connection

### ⚠ WARNING

#### Device is live!

Incorrect connection may result in injury or death!

- ▶ The electrical connection may be performed only by an electrical technician.
- ▶ The electrical technician must have read and understood these Operating Instructions and must follow the instructions contained therein.
- ▶ **Prior** to commencing connection work, ensure that no voltage is present on any cable.

## 5.1 Connecting the sensor

The electrical connection of the sensor to the transmitter is established using the measuring cable CYK10.

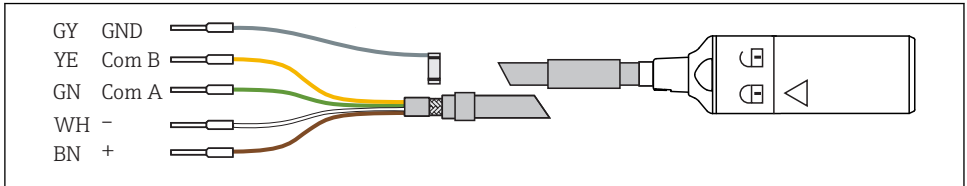

A0024019

5 Measuring cable CYK10

## 5.2 Ensuring the degree of protection

Only the mechanical and electrical connections which are described in these instructions and which are necessary for the required, designated use, may be carried out on the device delivered.

- ▶ Exercise care when carrying out the work.

Otherwise, the individual types of protection (Ingress Protection (IP), electrical safety, EMC interference immunity) agreed for this product can no longer be guaranteed due, for example to covers being left off or cable (ends) that are loose or insufficiently secured.

## 5.3 Post-connection check

### **⚠ WARNING**

#### Connection errors

The safety of people and of the measuring point is at risk! The manufacturer does not accept any responsibility for errors that result from failure to comply with the instructions in this manual.

- ▶ Put the measuring point into operation only if you can answer **yes** to **all** the following questions.

#### Product status and specifications

- ▶ Are the sensor and cable free from damage on the outside?

#### Electrical connection

- ▶ Is the installed cable strain-relieved and not twisted?
- ▶ Is a sufficient length of the cable cores stripped, and are the cores correctly positioned in the terminal on the transmitter?
- ▶ Are all plug-in terminals on the transmitter securely engaged?
- ▶ Are all cable entries mounted on the transmitter, tightened and leak-tight?

## 6 Commissioning

Prior to initial commissioning, ensure that:

- The sensor is correctly installed
- The electrical connection is correct

1. Check the temperature compensation and damping settings on the transmitter.

 Operating Instructions of the transmitter being used, e.g. BA01245C if using Liquiline CM44x or CM44xR.

### WARNING

#### Escaping process medium

Risk of injury from high pressure, high temperatures or chemical hazards!

- ▶ Before applying pressure to an assembly with cleaning system, ensure that the system has been connected correctly.
- ▶ If you cannot reliably establish the correct connection, do not install the assembly in the process.

If using an assembly with automatic cleaning function:

2. Check that the cleaning medium (water or air, for example) is connected correctly.

3. Following commissioning:

Maintain the sensor at regular intervals.

- ↳ This is the only way to ensure reliable measurements.

 As the sensor can be operated with a nominal pressure greater than 1 bar (15 psi), it has been registered according to CSA B51 ("Boiler, pressure vessel, and pressure piping code"; category F) with a CRN (Canadian Registration Number) in all Canadian provinces.

The CRN is located on the nameplate.

## 7 Maintenance

### 7.1 Cleaning the sensor

#### CAUTION

#### Corrosive chemicals

Risk of chemical burns to the eyes and skin and risk of damage to clothing and equipment!

- ▶ It is absolutely essential to protect the eyes and hands properly when working with acids, alkalis and organic solvents!
- ▶ Wear protective goggles and safety gloves.
- ▶ Clean away splashes on clothes and other objects to prevent any damage.
- ▶ Comply with instructions in the safety data sheets for the chemicals used.

**⚠ WARNING****Thiocarbamide**

Harmful if swallowed! Limited evidence of carcinogenicity! Possible risk of harm to the unborn child! Dangerous for the environment with long-term effects!

- ▶ Wear protective goggles, protective gloves and appropriate protective clothing.
- ▶ Avoid all contact with the eyes, mouth and skin.
- ▶ Avoid discharge into the environment.

Clean away fouling on the sensor as follows depending on the type of fouling:

1. Oily and greasy films:  
Clean with fat solvent, e.g. alcohol, or hot water and agents containing surfactants (alkaline) (e.g. dishwashing detergent).
2. Lime and metal hydroxide buildup and low solubility (lyophobic) organic buildup:  
Dissolve buildup with diluted hydrochloric acid (3 %) and then rinse thoroughly with plenty of clear water.
3. Sulfidic buildup (from flue gas desulfurization or wastewater treatment plants):  
Use a mixture of hydrochloric acid (3 %) and thiocarbamide (commercially available) and then rinse thoroughly with plenty of clear water.
4. Buildup containing proteins (e.g. food industry):  
Use a mixture of hydrochloric acid (0.5 %) and pepsin (commercially available) and then rinse thoroughly with plenty of clear water.
5. Readily soluble biological buildup:  
Rinse with pressurized water.

After cleaning, rinse the sensor thoroughly with water.

## 7.2 Sensor calibration

- ▶ Wall distance:  
When calibrating, ensure that there is a minimum distance of 15 mm to the base and walls of the calibration vessel.

# 8 Repair

## 8.1 General notes

The repair and conversion concept provides for the following:

- The product has a modular design
- Spare parts are grouped into kits which include the associated kit instructions
- Only use original spare parts from the manufacturer

- Repairs are carried out by the manufacturer's Service Department or by trained users
- Certified devices can only be converted to other certified device versions by the manufacturer's Service Department or at the factory
- Observe applicable standards, national regulations, Ex documentation (XA) and certificates

1. Carry out the repair according to the kit instructions.
2. Document the repair and conversion and enter, or have entered, in the Life Cycle Management tool (W@M).

## 8.2 Spare parts

Device spare parts that are currently available for delivery can be found on the website:

[www.endress.com/device-viewer](http://www.endress.com/device-viewer)

- ▶ Quote the serial number of the device when ordering spare parts.

## 8.3 Return

The product must be returned if repairs or a factory calibration are required, or if the wrong product was ordered or delivered. As an ISO-certified company and also due to legal regulations, Endress+Hauser is obliged to follow certain procedures when handling any returned products that have been in contact with medium.

To ensure the swift, safe and professional return of the device:

- ▶ Refer to the website [www.endress.com/support/return-material](http://www.endress.com/support/return-material) for information on the procedure and conditions for returning devices.

## 8.4 Disposal



If required by the Directive 2012/19/EU on waste electrical and electronic equipment (WEEE), the product is marked with the depicted symbol in order to minimize the disposal of WEEE as unsorted municipal waste. Do not dispose of products bearing this marking as unsorted municipal waste. Instead, return them to Endress+Hauser for disposal under the applicable conditions.

## 9 Accessories

The following are the most important accessories available at the time this documentation was issued.

- ▶ For accessories not listed here, please contact your Service or Sales Center.

### 9.1 Measuring cable

#### Memosens data cable CYK10

- For digital sensors with Memosens technology
- Product Configurator on the product page: [www.endress.com/cyk10](http://www.endress.com/cyk10)



Technical Information TI00118C

#### Memosens data cable CYK11

- Extension cable for digital sensors with Memosens protocol
- Product Configurator on the product page: [www.endress.com/cyk11](http://www.endress.com/cyk11)



Technical Information TI00118C

### 9.2 Calibration solutions

#### Conductivity calibration solutions CLY11

Precision solutions referenced to SRM (Standard Reference Material) by NIST for qualified calibration of conductivity measuring systems in accordance with ISO 9000

- CLY11-A, 74  $\mu\text{S}/\text{cm}$  (reference temperature 25 °C (77 °F)), 500 ml (16.9 fl.oz)  
Order No. 50081902
- CLY11-B, 149.6  $\mu\text{S}/\text{cm}$  (reference temperature 25 °C (77 °F)), 500 ml (16.9 fl.oz)  
Order No. 50081903
- CLY11-C, 1.406 mS/cm (reference temperature 25 °C (77 °F)), 500 ml (16.9 fl.oz)  
Order No. 50081904
- CLY11-D, 12.64 mS/cm (reference temperature 25 °C (77 °F)), 500 ml (16.9 fl.oz)  
Order No. 50081905
- CLY11-E, 107.00 mS/cm (reference temperature 25 °C (77 °F)), 500 ml (16.9 fl.oz)  
Order No. 50081906



Technical Information TI00162C

## 10 Technical data

### 10.1 Input

#### 10.1.1 Measured variables

- Conductivity
- Temperature

## 10.1.2 Measuring ranges

**Conductivity**<sup>1)</sup> 1 µS/cm to 500 mS/cm

1) In relation to water at 25 °C (77 °F)

**Temperature** -5 to 140 °C (23 to 284 °F)

### 10.1.3 Cell constant

$k = 0.57 \text{ cm}^{-1}$

### 10.1.4 Temperature compensation

Pt1000 (Class A according to IEC 60751)

## 10.2 Performance characteristics

### 10.2.1 Measuring uncertainty

Each individual sensor is factory-measured in a solution with approx. 50 µS/cm using a reference measuring system traceable to NIST or PTB. The exact cell constant is entered into the manufacturer inspection certificate supplied. The uncertainty of measurement in determining the cell constant is 1.0 %.

### 10.2.2 Response time

**Conductivity**  $t_{95} \leq 2 \text{ s}$

**Temperature**<sup>1)</sup>

With Pg 13.5 or Clamp  $t_{90} \leq 16 \text{ s}$ <sup>2)</sup>

With other process connection  $t_{90} \leq 28 \text{ s}$ <sup>2)</sup>

1) DIN VDI/VDE 3522-2 ( 0,3 m/s laminar)

2) With temperature prediction activated as standard

### 10.2.3 Maximum measured error

**Conductivity**

In the range 1 µS/cm to 1 mS/cm<sup>1)</sup>  $\leq 2 \%$  of reading

In the range 1 mS/cm to 500 mS/cm<sup>1)</sup>  $\leq 4 \%$  of reading

**Temperature**

With Pg 13.5 or Clamp  $\leq 0.5 \text{ K}$ , in measuring range -5 to 100 °C (23 to 212 °F)  
 $\leq 1.0 \text{ K}$ , in measuring range 100 to 140 °C (212 to 284 °F)

With other process connection  $\leq 1.0 \text{ K}$ , in measuring range -5 to 140 °C (23 to 284 °F)

1) In as-delivered state (factory adjustment at 50 µS/cm )



## 10.2.4 Repeatability

Conductivity	≤ 0.2 % of reading, in specified measuring range
Temperature	≤ 0.05 K

## 10.3 Environment

### 10.3.1 Ambient temperature

-20 to 60 °C (-4 to 140 °F)

### 10.3.2 Storage temperature

-25 to +80 °C (-10 to +180 °F)

### 10.3.3 Humidity

5 to 95 %

### 10.3.4 Degree of protection

IP 68 / NEMA type 6P (1.9 m water column, 20 °C, 24 h)

## 10.4 Process

### 10.4.1 Process temperature

Normal operation: -5 to 120 °C (23 to 248 °F)

Sterilization (max. 45 min.): Max. 140 °C (284 °F) at 6 bar (87 psi)

### 10.4.2 Process pressure

17 bar (247 psi) at 20 °C (68 °F)

9 bar (131 psi) at 120 °C (248 °F)

### 10.4.3 Temperature/pressure ratings

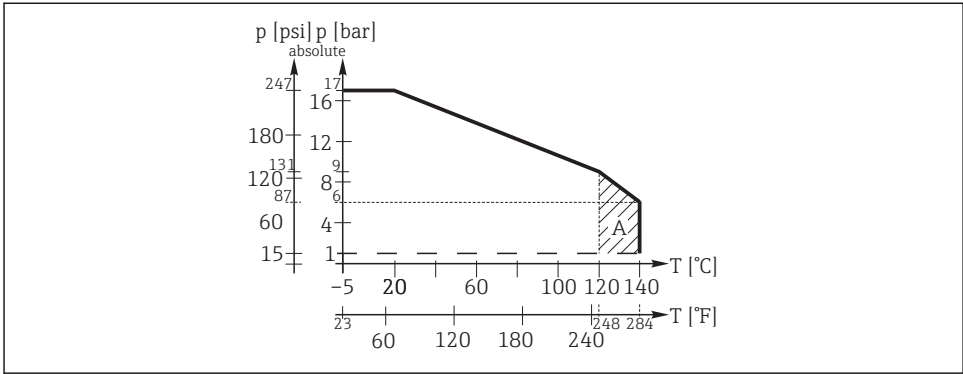

A0044758

#### 6 Pressure/temperature ratings

A Can be sterilized for a short time (45 min.)

## 10.5 Mechanical construction

### 10.5.1 Weight

Depending on the version, e.g.

- Process connection Pg 13.5: 0.06 to 0.09 kg (0.13 to 0.20 lbs)
- Process connection G1 or NPT: approx. 0.9 kg (1.98 lbs)

### 10.5.2 Materials (in contact with medium)

Sensor element: Platinum and ceramic (zirconium oxide)

Process connection: Stainless steel 1.4435 (AISI 316L)

Only for CLS82E-\*\*NA\*<sup>1)</sup> and CLS82E-\*\*NB\*<sup>2)</sup>:

Seal: EPDM

- 1) Connection DN25 standard
- 2) Connection DN25 B. Braun

### 10.5.3 Surface roughness

$R_a < 0.38 \mu\text{m}$

# Index

## A

Ambient temperature . . . . . 17

## C

Cell constant . . . . . 16

Check

    Connection . . . . . 11

    Mounting . . . . . 10

Connection

    Check . . . . . 11

    Ensuring the degree of protection . . . . . 11

## D

Degree of protection

    Ensuring . . . . . 11

    Technical data . . . . . 17

Disposal . . . . . 14

Documentation . . . . . 3

## E

Electrical connection . . . . . 10

Environment . . . . . 17

## I

Incoming acceptance . . . . . 5

Installation factor . . . . . 7

Intended use . . . . . 4

## M

Materials . . . . . 18

Maximum measured error . . . . . 16

Measured variables . . . . . 15

Measuring ranges . . . . . 16

Measuring uncertainty . . . . . 16

Mounting

    Check . . . . . 10

## N

Nameplate . . . . . 6

## O

Operational safety . . . . . 5

## P

Performance characteristics . . . . . 16

Pressure/temperature ratings . . . . . 18

Process . . . . . 17

Process pressure . . . . . 17

Process temperature . . . . . 17

Product identification . . . . . 6

Product safety . . . . . 5

## R

Repair . . . . . 13

Repeatability . . . . . 17

Response time . . . . . 16

Return . . . . . 14

## S

Safety

    Operation . . . . . 5

    Product . . . . . 5

    Workplace safety . . . . . 4

Safety instructions . . . . . 4

Scope of delivery . . . . . 6

Sensor

    Calibration . . . . . 13

    Cleaning . . . . . 12

    Connecting . . . . . 11

Spare parts . . . . . 14

Storage temperature . . . . . 17

Surface roughness . . . . . 18

Symbols . . . . . 3

## T

Technical data

    Environment . . . . . 17

    Input . . . . . 15

    Mechanical construction . . . . . 18

    Performance characteristics . . . . . 16

    Process . . . . . 17

Temperature compensation . . . . . 16

Temperature/pressure ratings . . . . . 18

## U

Use . . . . . 4

## W

Warnings . . . . . 3

Weight . . . . . 18

Workplace safety . . . . . 4



71545054

[www.addresses.endress.com](http://www.addresses.endress.com)

---