

Operating Instructions

CCS120D

Digital sensor with Memosens technology for determining total chlorine

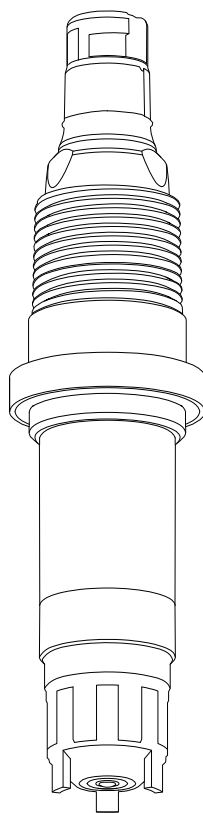





Table of contents







1	About this document	4	10.3 Disposal	33
1.1	Warnings	4		
1.2	Symbols used	4		
2	Basic safety instructions	6	11	Accessories
2.1	Requirements for personnel	6	11.1	Device-specific accessories
2.2	Designated use	6		34
2.3	Workplace safety	7	12	Technical data
2.4	Operational safety	7	12.1	Input
2.5	Product safety	7	12.2	Performance characteristics
			12.3	Environment
			12.4	Process
			12.5	Mechanical construction
3	Product description	8		
3.1	Product design	8	13	Installation and operation in
				hazardous environment Class
4	Incoming acceptance and			I Div. 2
	product identification	12		38
4.1	Incoming acceptance	12	Index	40
4.2	Product identification	12		
5	Installation	14		
5.1	Installation conditions	14		
5.2	Mounting the sensor	16		
5.3	Post-installation check	22		
6	Electrical connection	22		
6.1	Connecting the sensor	23		
6.2	Ensuring the degree of protection	23		
6.3	Post-connection check	23		
7	Commissioning	24		
7.1	Function check	24		
7.2	Filling the membrane cap with electrolyte	24		
7.3	Sensor polarization	24		
7.4	Sensor calibration	24		
8	Diagnostics and			
	troubleshooting	26		
9	Maintenance	28		
9.1	Maintenance schedule	28		
9.2	Maintenance tasks	28		
10	Repair	33		
10.1	Spare parts	33		
10.2	Return	33		

1 About this document



1.1 Warnings

Structure of information	Meaning
 <p>Causes (/consequences) If necessary, Consequences of non-compliance (if applicable) ▶ Corrective action</p>	<p>This symbol alerts you to a dangerous situation. Failure to avoid the dangerous situation will result in a fatal or serious injury.</p>
 <p>Causes (/consequences) If necessary, Consequences of non-compliance (if applicable) ▶ Corrective action</p>	<p>This symbol alerts you to a dangerous situation. Failure to avoid the dangerous situation can result in a fatal or serious injury.</p>
 <p>Causes (/consequences) If necessary, Consequences of non-compliance (if applicable) ▶ Corrective action</p>	<p>This symbol alerts you to a dangerous situation. Failure to avoid this situation can result in minor or more serious injuries.</p>
 <p>Cause/situation If necessary, Consequences of non-compliance (if applicable) ▶ Action/note</p>	<p>This symbol alerts you to situations which may result in damage to property.</p>

1.2 Symbols used

Symbol	Meaning
	Additional information, tips
	Permitted or recommended
	Not permitted or not recommended
	Reference to device documentation
	Reference to page
	Reference to graphic
	Result of a step

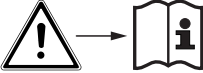
1.2.1 Symbols on the device

Symbol	Meaning
	Reference to device documentation
	Minimum immersion depth

2 Basic safety instructions

2.1 Requirements for personnel

Installation, commissioning, operation and maintenance of the measuring system may be carried out only by specially trained technical personnel.

- ▶ The technical personnel must be authorized by the plant operator to carry out the specified activities.
- ▶ The electrical connection may be performed only by an electrical technician.
- ▶ The technical personnel must have read and understood these Operating Instructions and must follow the instructions contained therein.
- ▶ Measuring point faults may be repaired only by authorized and specially trained personnel.



Repairs not described in the Operating Instructions provided must be carried out only directly at the manufacturer's site or by the service organization.

2.2 Designated use

Drinking water and industrial water must be disinfected through the addition of appropriate disinfectants such as chlorine gas or inorganic chlorine compounds. The dosing quantity must be adapted to continuously fluctuating operating conditions. If the concentrations in the water are too low, this could jeopardize the effectiveness of the disinfection. On the other hand, concentrations which are too high can lead to signs of corrosion and have an adverse effect on taste, as well as generating unnecessary costs.

The sensor was specifically developed for this application and is designed for continuous measurement of total chlorine in water. In conjunction with measuring and control equipment, it allows optimal control of disinfection.

In this context, the following compounds are referred to collectively as total chlorine:

- Free available chlorine: hypochlorous acid (HOCl), hypochlorite ions (OCl⁻)
- Combined chlorine (chloramines)
- Organic combined chlorine, e. g. cyanuric acid derivatives

Chloride (Cl⁻) is not recorded.



The sensor is not suitable for checking the absence of chlorine.

The sensor is particularly suitable for:

- Monitoring of total chlorine content in wastewater, industrial water, process water, cooling water and pool water
- Measurement, monitoring and control of total chlorine content in fresh water and seawater during the treatment of process water, swimming pool water and whirlpool bathwater

A typical application is the disinfection of wastewater, industrial, process and cooling water with disinfectants containing chlorine, particularly at higher pH values up to 9.5. In swimming pools, the CCS120D sensor is used in combination with the CCS51D sensor for free available chlorine to monitor the amount of combined chlorine (chloramines).

Use of the device for any purpose other than that described, poses a threat to the safety of people and of the entire measuring system and is therefore not permitted.

The manufacturer is not liable for damage caused by improper or non-designated use.

2.2.1 Hazardous environment in accordance with cCSAus NI Cl. I, Div. 2¹⁾

- ▶ Pay attention to the control drawing and the specified application conditions in the appendix of these Operating Instructions, and follow the instructions.

2.3 Workplace safety

As the user, you are responsible for complying with the following safety conditions:

- Installation guidelines
- Local standards and regulations

Electromagnetic compatibility

- The product has been tested for electromagnetic compatibility in accordance with the applicable international standards for industrial applications.
- The electromagnetic compatibility indicated applies only to a product that has been connected in accordance with these Operating Instructions.

2.4 Operational safety

Before commissioning the entire measuring point:

1. Verify that all connections are correct.
2. Ensure that electrical cables and hose connections are undamaged.
3. Do not operate damaged products, and protect them against unintentional operation.
4. Label damaged products as defective.

During operation:

- ▶ If faults cannot be rectified:
products must be taken out of service and protected against unintentional operation.

2.4.1 Special instructions

- ▶ Do not operate the sensors under process conditions where it is expected that osmotic conditions will cause electrolyte components to pass through the membrane and into the process.

Use of the sensor for its intended purpose in liquids with a conductivity of at least 10 nS/cm can be classified as safe in terms of the application.

2.5 Product safety

The product is designed to meet state-of-the-art safety requirements, has been tested, and left the factory in a condition in which it is safe to operate. The relevant regulations and international standards have been observed.

1) Only if connected to CM44x(R)-CD*

3 Product description

3.1 Product design

The sensor consists of the following functional units:

- Membrane cap (measuring chamber with membrane)
 - Separates the inner amperometric system from the medium
 - With robust PET membrane and pressure relief valve
 - Guarantees a defined and consistent electrolyte film between working electrode and membrane
- Sensor shaft with
 - Large counter electrode
 - Working electrode embedded in plastic
 - Embedded temperature sensor

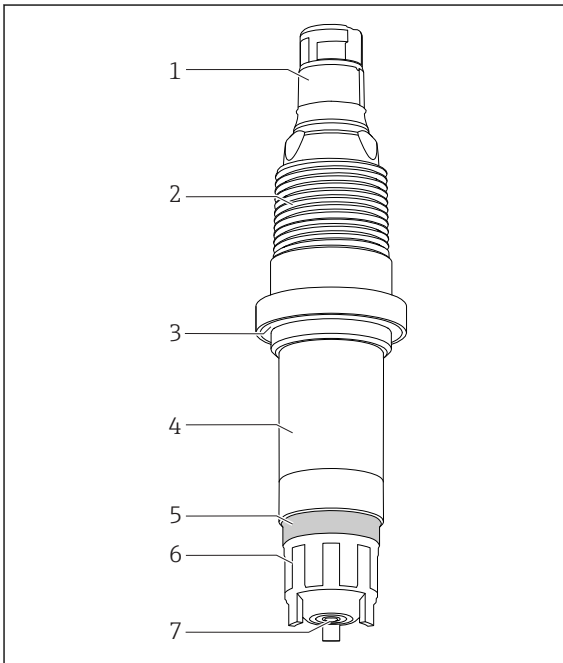

- 1 Memosens plug-in head
- 2 NPT 3/4" thread
- 3 O-ring
- 4 Sensor shaft
- 5 Pressure relief valve (elastic)
- 6 Membrane cap
- 7 Sensor membrane

A0037693

 1 Sensor structure

3.1.1 Measuring principle

Total chlorine levels are determined in accordance with the amperometric measuring principle.

In this context, the following compounds are referred to collectively as total chlorine:

- Free available chlorine: hypochlorous acid (HOCl), hypochlorite ions (OCl⁻)
- Combined chlorine (chloramines)
- Organic combined chlorine, e.g. cyanuric acid derivatives

Chloride (Cl⁻) is not recorded.

The sensor is a membrane-covered, two-electrode sensor. A platinum working electrode is used as the working electrode. A counter electrode coated in silver halide is used as the counter and reference electrode.

The membrane cap, which is filled with electrolyte, constitutes the measuring chamber. The measuring electrodes are immersed in the measuring chamber. The measuring chamber is separated from the medium by means of a microporous membrane. The chlorine compounds contained in the medium diffuse through the sensor membrane.

The constant polarization voltage present between the two electrodes causes the electrochemical reaction of the chlorine compounds at the working electrode. Electron donation at the working electrode and electron acceptance at the counter-electrode cause a current to flow. In the operational range of the sensor, this current flow is proportional to the chlorine concentration under constant conditions and is only slightly pH-dependent in the case of this sensor type. The transmitter uses the current signal to calculate the measured variable for concentration in mg/l (ppm).

3.1.2 Effects on the measured signal

pH value

pH dependency

The sensor is specified for the pH range of pH 5.5 to 9.5. The measuring signal is practically independent within this range. However, if the pH increases from pH 7 to pH 8 the measuring signal for free chlorine is reduced by 10 %.

Flow

The flow to the membrane-covered measuring cell should be at least 15 cm/s and maximum 50 cm/s. The optimum flow velocity is in the 20 to 30 cm/s range.

When using the CCA250 flow assembly, the minimum flow velocity corresponds to a volume flow of 30 l/h (7.9 gal/h) (upper edge of float at the height of the red bar mark).

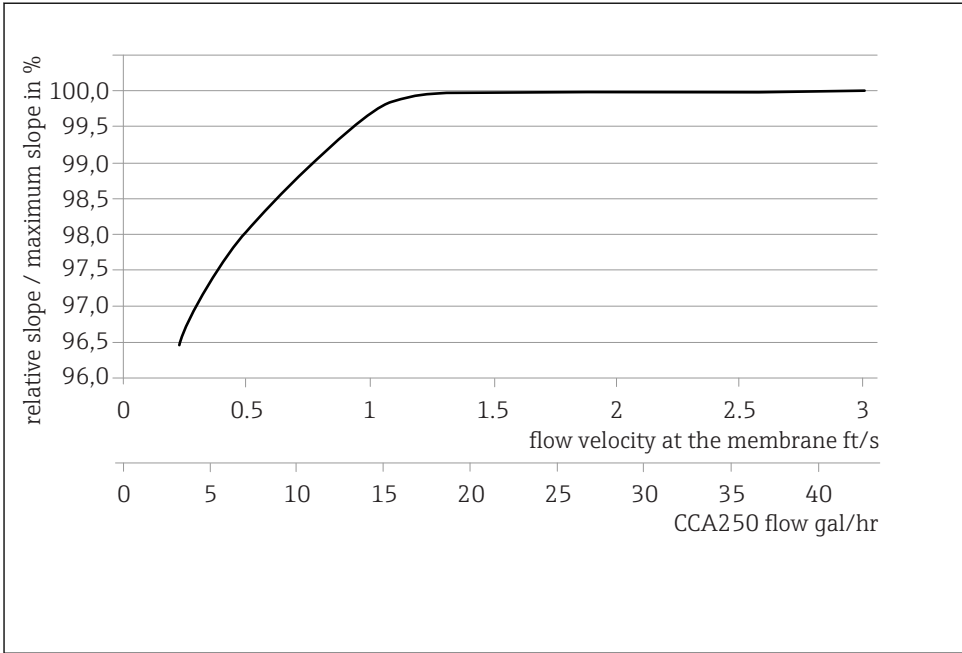

A0039131-EN

- 2 Correlation between slope of electrode and flow velocity at the membrane/volume flow in assembly

At higher flow rates, the measured signal is virtually flow-independent. However, if the flow rate falls below the specified value, the measured signal depends on the flow.

Temperature

Changes in the temperature of the medium affect the measured value:

- Increases in temperature result in a higher measured value (approx. 4 % per K)
- Decreases in temperature result in a lower measured value.

Use of the sensor in combination with the Liquiline enables automatic temperature compensation (ATC). Recalibration in the case of temperature changes is not necessary.

1. If automatic temperature compensation is disabled at the transmitter, the temperature must be maintained at a constant level following calibration.
2. Otherwise, recalibrate the sensor.

In the event of normal and slow changes in temperature (0.3 K / minute), the internal temperature sensor is sufficient. In the event of very rapid temperature fluctuations with high amplitude (2 K / minute), an external temperature sensor is necessary to ensure maximum accuracy.

Cross-sensitivities ²⁾

Oxidants, such as bromine, iodine, ozone, chlorine dioxide, permanganate, peracetic acid and hydrogen peroxide result in higher readings than expected.

Reducing agents, such as sulfides, sulfites, thiosulfates and hydrazine, result in lower readings than expected.

2) The listed substances have been tested with different concentrations. An additive effect has not been investigated.

4 Incoming acceptance and product identification

4.1 Incoming acceptance

1. Verify that the packaging is undamaged.
 - ↳ Notify the supplier of any damage to the packaging.
Keep the damaged packaging until the issue has been resolved.
2. Verify that the contents are undamaged.
 - ↳ Notify the supplier of any damage to the delivery contents.
Keep the damaged goods until the issue has been resolved.
3. Check that the delivery is complete and nothing is missing.
 - ↳ Compare the shipping documents with your order.
4. Pack the product for storage and transportation in such a way that it is protected against impact and moisture.
 - ↳ The original packaging offers the best protection.
Make sure to comply with the permitted ambient conditions.

If you have any questions, please contact your supplier or your local Sales Center.

4.2 Product identification

4.2.1 Nameplate

The nameplate provides you with the following information on your device:

- Manufacturer identification
- Extended order code
- Serial number
- Safety information and warnings

- ▶ Compare the information on the nameplate with the order.

4.2.2 Product page

www.endress.com/ccs120d

4.2.3 Interpreting the order code

The order code and serial number of your product can be found in the following locations:

- On the nameplate
- In the delivery papers

Obtaining information on the product

1. Go to www.endress.com.
2. Call up the site search (magnifying glass).
3. Enter a valid serial number.
4. Search.
 - ↳ The product structure is displayed in a popup window.

5. Click on the product image in the popup window.
- ↳ A new window (**Device Viewer**) opens. All of the information relating to your device is displayed in this window as well as the product documentation.

4.2.4 Manufacturer address

Endress+Hauser Conducta GmbH+Co. KG
 Dieselstraße 24
 D-70839 Gerlingen

4.2.5 Scope of delivery

The delivery comprises:

- Disinfection sensor (membrane-covered)
- Bottle with electrolyte (50 ml (1.69 fl.oz)) and nozzle
- Replacement membrane cap
- Operating Instructions
- Manufacturer's certificate

4.2.6 Certificates and approvals

CE mark

Declaration of Conformity

The product meets the requirements of the harmonized European standards. As such, it complies with the legal specifications of the EU directives. The manufacturer confirms successful testing of the product by affixing to it the **CE** mark.

EAC

The product has been certified according to guidelines TP TC 004/2011 and TP TC 020/2011 which apply in the European Economic Area (EEA). The EAC conformity mark is affixed to the product.

Ex approvals³⁾

cCSAus NI Cl. I, Div. 2

This product complies with the requirements defined in:

- UL 61010-1
- ANSI/ISA 12.12.01
- FM 3600
- FM 3611
- CSA C22.2 NO. 61010-1-12
- CSA C22.2 NO. 213-16
- Control drawing: 401204

3) Only if connected to CM44x(R)-CD*

5 Installation

5.1 Installation conditions

5.1.1 Installation position

Do not install upside-down!

- ▶ Install the sensor in an assembly, support or appropriate process connection at an angle of at least 15° to the horizontal.
- ▶ Other angles of inclination are not permitted.
- ▶ Follow the instructions for installing the sensor in the Operating Instructions of the assembly used.

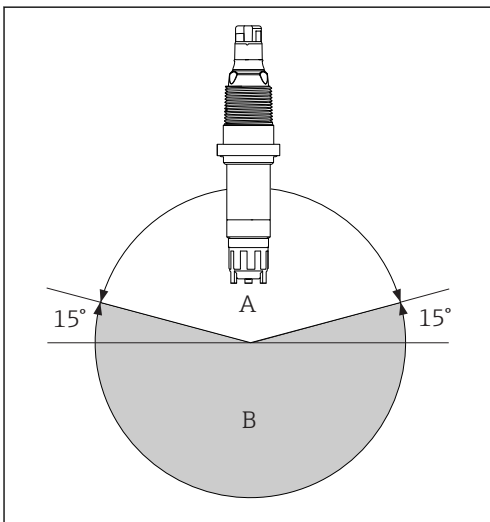

A Permitted orientation

B Incorrect orientation

A0037695

5.1.2 Immersion depth

At least 70 mm (2.76 in)

5.1.3 Dimensions

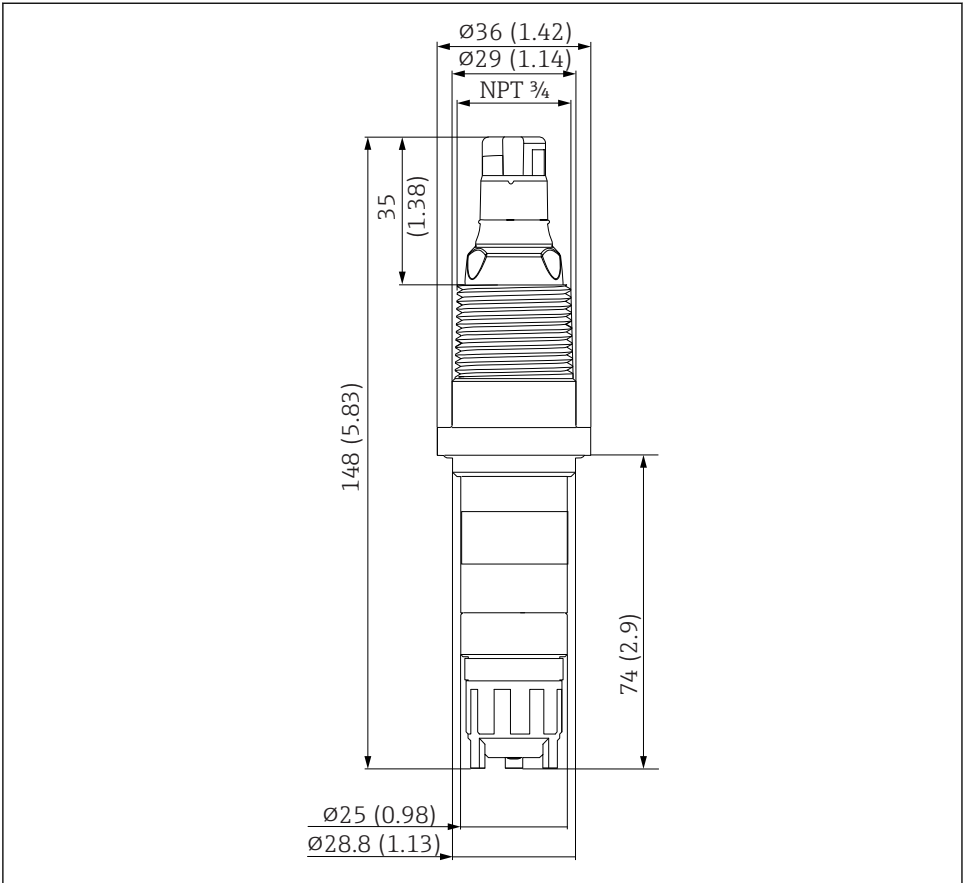

A0038260

3 Dimensions in mm (in)

5.2 Mounting the sensor

5.2.1 Measuring system

A complete measuring system comprises:

- CCS120D disinfection sensor (membrane-covered)
- Flexdip CYA112 immersion assembly
- Measuring cable CYK10, CYK20
- Transmitter, e. g. Liquiline CM44x with firmware version 01.06.08 or higher or CM44xR with firmware version 01.06.08 or higher
- Optional: extension cable CYK11
- Optional: Flowfit CCA250 flow assembly (a pH/ORP sensor can additionally be installed here)

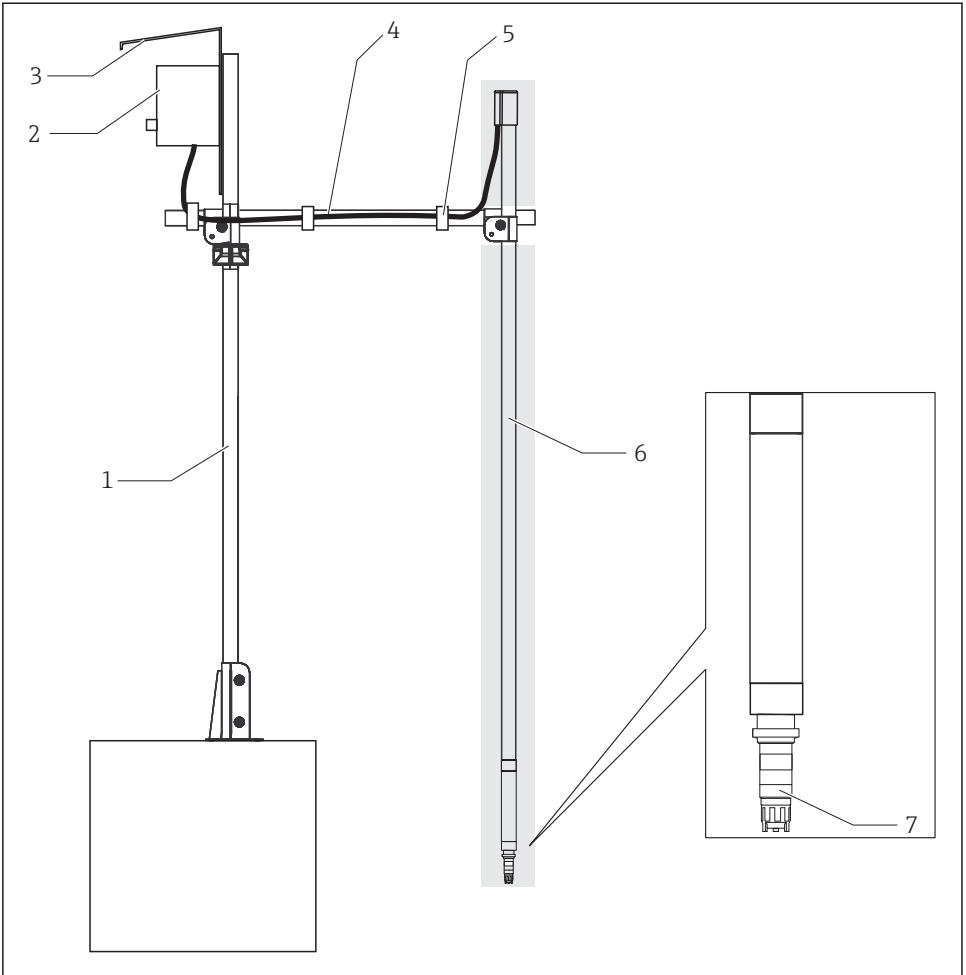

A0038294

4 Example of a measuring system

- 1 CYH112 holder, main pipe
- 2 Transmitter
- 3 Protective cover
- 4 CYH112 holder, transverse pipe
- 5 Hook-and-loop tape
- 6 CYA112 assembly (gray background)
- 7 Disinfection sensor CCS120D (membrane-covered, $\varnothing 25$ mm)

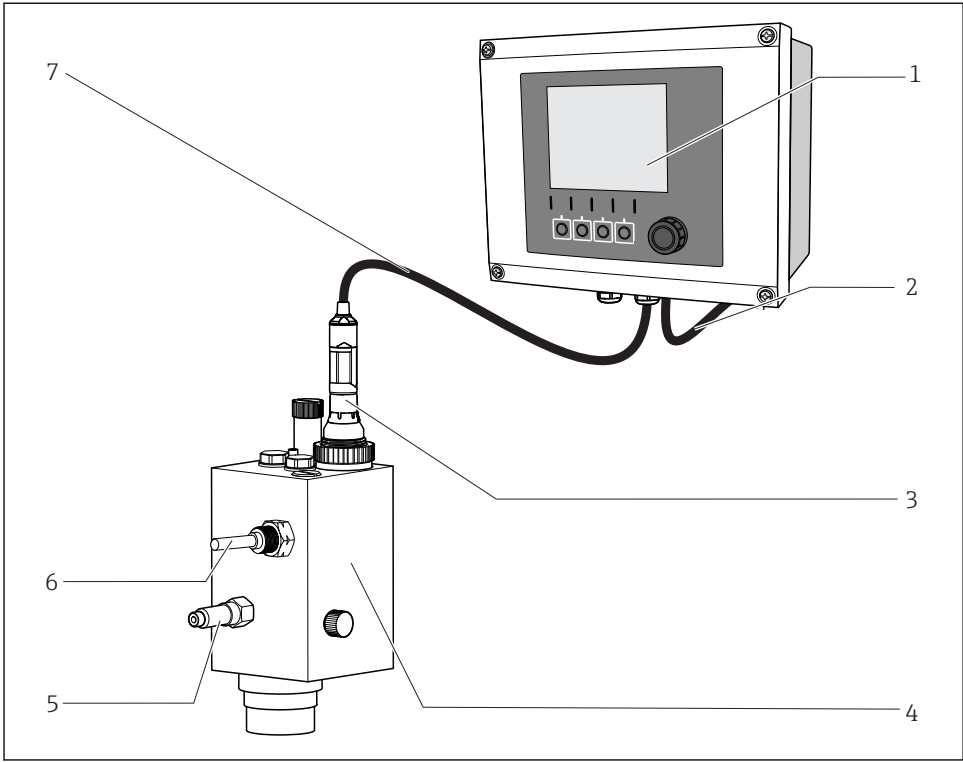

A0038946

5 Example of a measuring system

- 1 Liquiline CM44x transmitter
- 2 Power cable for transmitter
- 3 Disinfection sensor CCS120D (membrane-covered, $\varnothing 25$ mm)
- 4 Flowfit CCA250 flow assembly
- 5 Inlet to Flowfit CCA250 flow assembly
- 6 Proximity switch (optional)
- 7 Measuring cable CYK10

5.2.2 Preparing the sensor

Removing protection cap from sensor

NOTICE

Negative pressure causes damage to the sensor's membrane cap

► If the protection cap is attached, carefully remove it from sensor.

1. When supplied to the customer and when in storage, the sensor is fitted with a protection cap: First release just the top part of the protection cap by turning it.

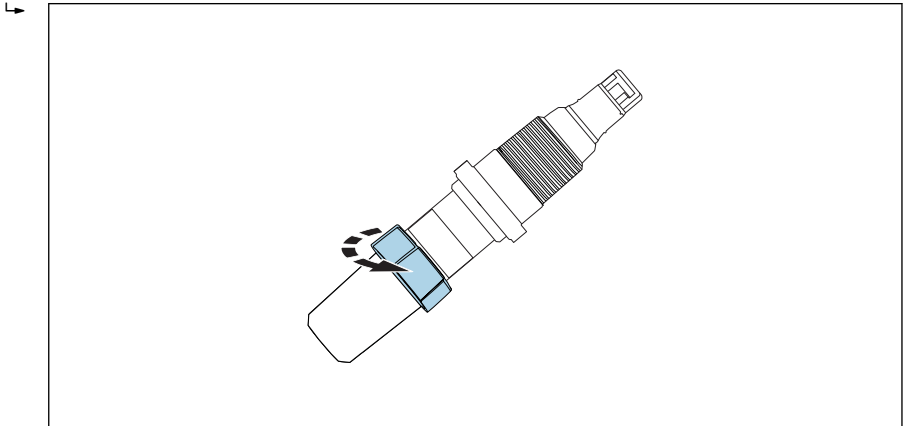

A0037884

 6 Releasing top part of protection cap by turning

2. Carefully remove protection cap from sensor.

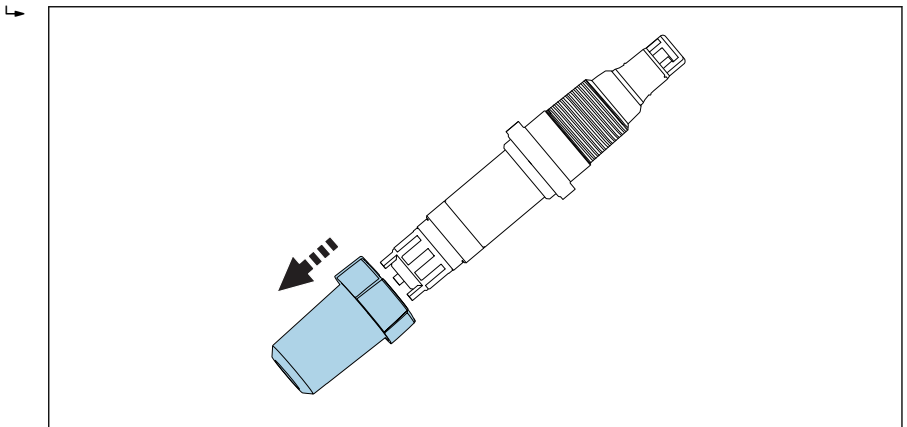

A0037885

 7 Carefully remove protection cap

Filling the membrane cap with electrolyte



Please note the information on the safety data sheet to ensure safe use of the electrolyte.

NOTICE

Damage to membrane and electrodes, air bubbles

Possibility of measured errors to complete failure of the measuring point

- ▶ Avoid damage to membrane and electrodes.
- ▶ The electrolyte is chemically neutral and is not hazardous to health. Nonetheless, do not swallow it and avoid contact with eyes.
- ▶ Keep the electrolyte bottle closed after use. Do not transfer electrolyte to other vessels.
- ▶ Do not store electrolyte for longer than one year. The electrolyte must not be yellow in color. Observe the use-by date on the label.
- ▶ Avoid air bubbles when pouring electrolyte into membrane cap.
- ▶ Only use membrane cap once.
- ▶ Store the electrolyte bottle upside down (standing on its head) to ensure that the viscous electrolyte can be decanted as easily as possible with minimum bubbles. Smaller air bubbles are not a problem. Larger air bubbles rise to the upper edge of the membrane cap.

Filling the membrane cap with electrolyte



The sensor is dry when delivered from the factory. Before using the sensor, fill the membrane cap with electrolyte.

1. Open the electrolyte bottle. Screw the nozzle onto the electrolyte bottle.
2. Press out any excess air.
3. Place the electrolyte bottle on the membrane cap.
4. Using a single movement, slowly push the electrolyte into the membrane cap until it reaches the lower turn of the thread. Withdraw the electrolyte bottle smoothly.
5. Slowly screw on membrane cap up to the stop . This will cause excess electrolyte to be displaced at the valve and thread.
6. If necessary, pat the sensor and membrane cap dry using a cloth.
7. Thoroughly clean the nozzle with a clean, warm and strong jet of water to ensure that any electrolyte is removed.
8. Reset operating hours counter for electrolyte on transmitter. For detailed information, see Operating Instructions for transmitter.

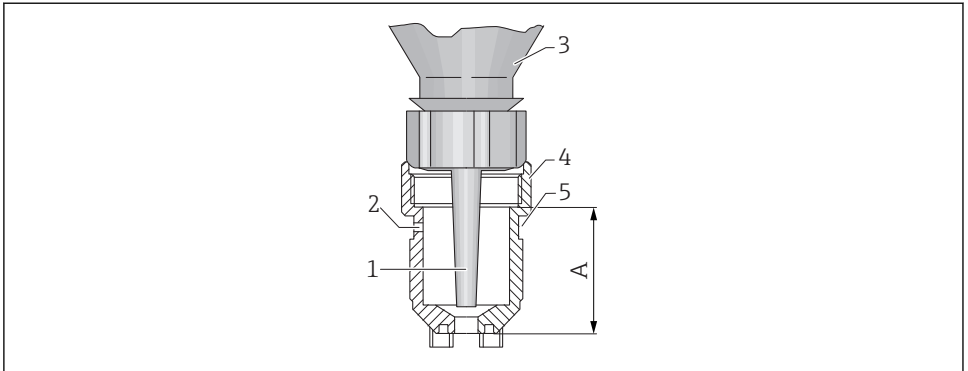

A0037963

 8 Membrane cap with electrolyte bottle

- 1 Nozzle
- 2 Ventilation hole
- 3 Electrolyte bottle
- 4 Membrane cap
- 5 Hose seal
- A Electrolyte level

5.2.3 Installing sensor in CCA250 assembly

The Flowfit CCA250 flow assembly is designed for installing the sensor. It allows a pH and an ORP sensor to also be installed, in addition to the total chlorine sensor. A needle valve controls the flow rate in the range of 30 to 120 l/h (7.9 to 31.7 gal/h).

Please note the following during installation:

- ▶ The flow rate must be at least 30 l/h (7.9 gal/h). If the flow drops below this value or stops completely, this can be detected by an inductive proximity switch.
- ▶ If the medium is fed back into an overflow basin, pipe or similar, the resulting counterpressure on the sensor may not exceed 1 bar (14.5 psi) (2 bar abs. (29 psi abs.)) and must remain constant.
- ▶ Negative pressure at the sensor, e.g. due to medium being returned to the suction side of a pump, must be avoided.
- ▶ To avoid buildup, heavily contaminated water should also be filtered.



Additional installation instructions can be found in the Operating Instructions for the assembly.

5.2.4 Installing sensor in other flow assemblies

When using other flow assemblies, please ensure the following:

- ▶ A flow velocity of at least 15 cm/s (0.49 ft/s) must always be ensured at the membrane.
- ▶ The flow direction is upwards. Transported air bubbles must be removed so that they do not collect in front of the membrane.

- ▶ The flow must be directed to the membrane.

 Pay attention to the additional installation instructions in the Operating Instructions for the assembly.

5.2.5 Installing sensor in immersion assembly CYA112

Alternatively, the sensor can be installed in an immersion assembly with threaded connection NPT 3/4", e. g. CYA112.

Please note the following during installation:

- ▶ Do not twist the sensor measuring cable. Recommendation: use a quick release fastener.
- ▶ To improve the sealing effect, we recommend you wrap a thin PTFE tape around the thread for assemblies with an NPT 3/4" thread.

 Additional installation instructions can be found in the Operating Instructions for the assembly.

5.3 Post-installation check

1. Check the membrane to ensure it is sealed and undamaged.
 - ↳ Replace if necessary.
2. Is the sensor installed in an assembly and not suspended from the cable?
 - ↳ The sensor may be installed only in an assembly or directly via the process connection.

6 Electrical connection

CAUTION

Device is live

Incorrect connection may result in injury!

- ▶ The electrical connection may be performed only by an electrical technician.
- ▶ The electrical technician must have read and understood these Operating Instructions and must follow the instructions contained therein.
- ▶ **Prior** to commencing connection work, ensure that no voltage is present on any cable.

6.1 Connecting the sensor

The electrical connection to the transmitter is established using measuring cable CYK10 or CYK20.

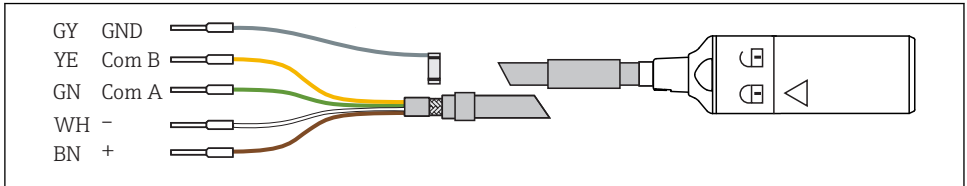

A0024019

9 Measuring cable CYK10/CYK20

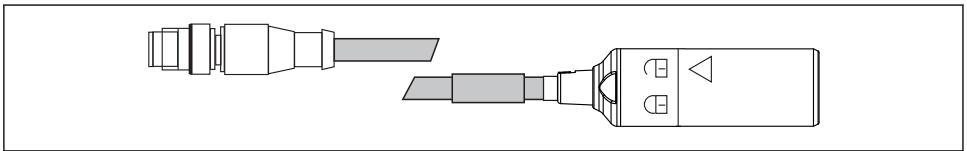

A0018861

10 Electrical connection, M12 plug

6.2 Ensuring the degree of protection

Only the mechanical and electrical connections which are described in these instructions and which are necessary for the required, designated use, may be carried out on the device delivered.

- ▶ Exercise care when carrying out the work.

Otherwise, the individual types of protection (Ingress Protection (IP), electrical safety, EMC interference immunity) agreed for this product can no longer be guaranteed due, for example to covers being left off or cable (ends) that are loose or insufficiently secured.

6.3 Post-connection check

Device condition and specifications	Notes
Are the sensor, assembly, or cables free from damage on the outside?	Visual inspection
Electrical connection	Notes
Are the mounted cables strain-relieved and not twisted?	
Is a sufficient length of the cable cores stripped, and are the cores positioned in the terminal correctly?	Check the fit (by pulling gently)
Are all the screw terminals properly tightened?	Tighten
Are all the cable entries installed, tightened and sealed?	For lateral cable entries, make sure the cables loop downwards to allow water to drip off
Are all cable entries installed downwards or mounted laterally?	

7 Commissioning

7.1 Function check

Prior to initial commissioning, ensure that:

- The sensor is correctly installed.
- The electrical connection is correct.
- There is sufficient electrolyte in the membrane cap and the transmitter is not displaying a warning about electrolyte depletion.



Please note the information on the safety data sheet to ensure safe use of the electrolyte.



Always keep the sensor moist after commissioning.

⚠ WARNING

Escaping process medium

Risk of injury from high pressure, high temperatures or chemical hazards

- ▶ Before applying pressure to an assembly with cleaning system, ensure that the system has been connected correctly.
- ▶ Do not install the assembly in the process if you cannot reliably establish the correct connection.

7.2 Filling the membrane cap with electrolyte

Fill the membrane cap with electrolyte

The sensor is dry when delivered from the factory.

- ▶ Fill the membrane cap with electrolyte before commissioning the sensor → 20.

7.3 Sensor polarization

The voltage applied by the transmitter between the working electrode and counter electrode polarizes the surface of the working electrode. Therefore, after switching on the transmitter with the sensor connected, you must wait until the polarization period has elapsed before starting calibration.

Polarization time: → 36

7.4 Sensor calibration

Reference measurement according to the DPD method

To calibrate the measuring system, carry out a colorimetric comparison measurement according to the DPD-1/DPD-3 method. Chlorine reacts with diethyl-p-phenyldiamine (DPD) producing a red dye, the intensity of the red color being proportional to the chlorine content. Alternatively, the DPD 4 method can also be used.

Measure the intensity of the red color using a photometer (e. g. PF-3 → 34) . The photometer indicates the chlorine content.

Requirements

The sensor reading is stable (no drifts or unsteady values for at least 5 minutes). This is normally guaranteed once the following preconditions have been met:

- The polarization period has elapsed.
- The flow is constant and within the correct range.
- The sensor and the medium are at the same temperature.
- The pH value is within the permitted range.

Zero point adjustment

A zero point adjustment is not required due to the zero point stability of the membrane-covered sensor.

Slope calibration



Always perform a slope calibration in the following cases:

- After replacing the membrane cap
- After replacing electrolyte

The slope of the sensor is strongly influenced by the application conditions. The interval for the slope calibration must be adjusted accordingly.

Repeat the slope calibration at regular intervals.



Recommended calibration intervals → 28





1. Ensure that the pH value and temperature of the medium are constant.
2. Take a representative sample for the DPD measurement. This must be done in close proximity to the sensor. Use the sampling tap if available.
3. Determine the chlorine content using the DPD method.
4. Enter the measured value into the transmitter (see Operating Instructions for transmitter).
5. To ensure greater accuracy, check the calibration several hours or 24 hours later using the DPD method.

8 Diagnostics and troubleshooting

When troubleshooting, the entire measuring point must be taken into account. This comprises:

- Transmitter
- Electrical connections and lines
- Assembly
- Sensor



The possible causes of error in the following table refer primarily to the sensor. Before commencing troubleshooting, ensure that the following operating conditions have been met:

- The chlorine content is within the measuring range of the sensor (check with the DPD-1/DPD-3 method) →  35.
- The pH value is within the pH range of the sensor →  37.
- The temperature is within the temperature range of the sensor →  37.
- The conductivity is within the conductivity range of the sensor →  37.
- Measurement in "temperature-compensated" mode (can be configured on transmitter CM44x) or constant temperature following calibration
- Medium flow rate of at least 30 l/h (7.9 gal/h) (red bar mark when using the CCA250 flow assembly)



If the value measured by the sensor differs significantly from that of the DPD method, first consider all possible malfunctions of the photometric DPD method (see Operating Instructions for photometer). If necessary, repeat the DPD measurement several times.

Error	Possible cause	Remedy
No display, no sensor current	No supply voltage at the transmitter	▶ Establish mains connection
	Connection cable between sensor and transmitter interrupted	▶ Establish cable connection
	There is no electrolyte in the membrane cap	▶ Fill membrane cap with fresh electrolyte →  29
	No input flow of medium	▶ Establish flow, clean filter
	Zero point has shifted	<ol style="list-style-type: none"> 1. Check condition of counter electrode. 2. Reset transmitter to factory settings.
Display value too high	Polarization of the sensor not yet completed	▶ Wait for polarization to be completed
	Membrane defective	▶ Replace membrane cap
	Shunt resistance (e.g. moisture contact) in the sensor shaft	<ul style="list-style-type: none"> ▶ Remove membrane cap, rub working electrode dry. ▶ If the transmitter display does not return to zero, there is a shunt present: replace sensor.
	Foreign oxidants interfering with sensor	▶ Examine medium, check chemicals
	DPD chemicals are too old	▶ Replace DPD chemicals.
	pH value < pH 5	▶ Stay within permitted pH range (pH 5.5 to 9.5).

Error	Possible cause	Remedy
Display value too low	Membrane cap not screwed on fully	<ul style="list-style-type: none"> ▶ Fill membrane cap with fresh electrolyte →  29 ▶ Screw membrane cap on fully
	Membrane soiled	▶ Clean membrane →  28
	Air bubble in front of membrane	▶ Release air bubble
	Air bubble between working electrode and membrane	<ul style="list-style-type: none"> ▶ Remove membrane cap, top up electrolyte ▶ Remove air bubble by tapping on the outside of the membrane cap ▶ Screw on membrane cap
	Input flow of medium too low	▶ Establish correct flow
	Foreign oxidants interfering with DPD reference measurement	▶ Examine medium, check chemicals
	Use of organic disinfectants	<ul style="list-style-type: none"> ▶ Use suitable agent (e.g. as per DIN 19643) (water may need to be replaced first) ▶ Use suitable reference system
	Polarization time is too low	▶ Wait for polarization to be completed
	pH value	▶ Stay within permitted pH range (pH 5.5 to 9.5).
	There is no electrolyte in the membrane cap	▶ Fill membrane cap with fresh electrolyte →  29
Display fluctuates considerably	Hole in membrane	▶ Replace membrane cap
	Fluid pressure variations	▶ Adjust the process

9 Maintenance



Please note the information on the safety data sheet to ensure safe use of the electrolyte.

Take all the necessary precautions in time to ensure the operational safety and reliability of the entire measuring system.

NOTICE

Effects on process and process control!

- ▶ When carrying out any work on the system, bear in mind any potential impact this could have on the process control system and the process itself.
- ▶ For your own safety, only use genuine accessories. With genuine parts, the function, accuracy and reliability are also ensured after maintenance work.

9.1 Maintenance schedule

Interval	Maintenance work
If deposits are visible on the membrane (biofilm, limescale)	Clean sensor membrane → 29
If dirt is visible on the surface of the electrode body	Clean electrode body of sensor
Recommended calibration intervals: <ul style="list-style-type: none"> ▪ Drinking water, industrial water, process water, cooling water: depending on the special conditions (1 to 4 weeks) ▪ Swimming pools: weekly ▪ Whirlpools: daily 	Sensor calibration
<ul style="list-style-type: none"> ▪ If cap is replaced ▪ If the slope is too low or too high relative to the nominal slope and the membrane cap is not visibly damaged or dirty 	Fill membrane cap with fresh electrolyte → 29
<ul style="list-style-type: none"> ▪ If there are grease/oil deposits (dark or transparent spots on the membrane) ▪ If slope is too high or too low or sensor current is very noisy ▪ If it is obvious that the sensor current is significantly dependent on the temperature (temperature compensation not working). 	Replace membrane cap → 29
In the event of visible silvery or white changes to the counter electrode (brown/gray or yellow/green discoloration is not a problem)	Regenerate sensor → 32

9.2 Maintenance tasks

9.2.1 Cleaning the sensor

Removing the sensor from assembly CCA151

1. Remove the cable.
2. Unscrew the union nut from the assembly.
3. Pull sensor out through opening in assembly.

Cleaning sensor membrane

If the membrane is visibly soiled, proceed as follows:

1. Remove sensor from flow assembly.
2. Only clean membrane mechanically with a gentle jet of water.

9.2.2 Filling membrane cap with fresh electrolyte



Please note the information on the safety data sheet to ensure safe use of the electrolyte.

NOTICE

Damage to membrane and electrodes, air bubbles

Possibility of measured errors to complete failure of the measuring point

- ▶ Avoid damage to membrane and electrodes.
- ▶ The electrolyte is chemically neutral and is not hazardous to health. Nonetheless, do not swallow it and avoid contact with eyes.
- ▶ Keep the electrolyte bottle closed after use. Do not transfer electrolyte to other vessels.
- ▶ Do not store electrolyte for longer than one year. The electrolyte must not be yellow in color. Observe the use-by date on the label.
- ▶ Avoid air bubbles when pouring electrolyte into membrane cap.
- ▶ Only use membrane cap once.

Fill the membrane cap with electrolyte → 20

9.2.3 Replacing membrane cap

1. Remove sensor from flow assembly.
2. Remove membrane cap → 30.
3. Fill new membrane cap with fresh electrolyte → 20.
4. Check the condition of the sealing ring and check whether the sealing ring is mounted on the shaft.
5. Screw new membrane cap onto sensor shaft → 30.
6. Reset operating hours counter for membrane cap on transmitter. For detailed information, see Operating Instructions for transmitter.

Remove membrane cap

- ▶ Carefully rotate membrane cap and remove.

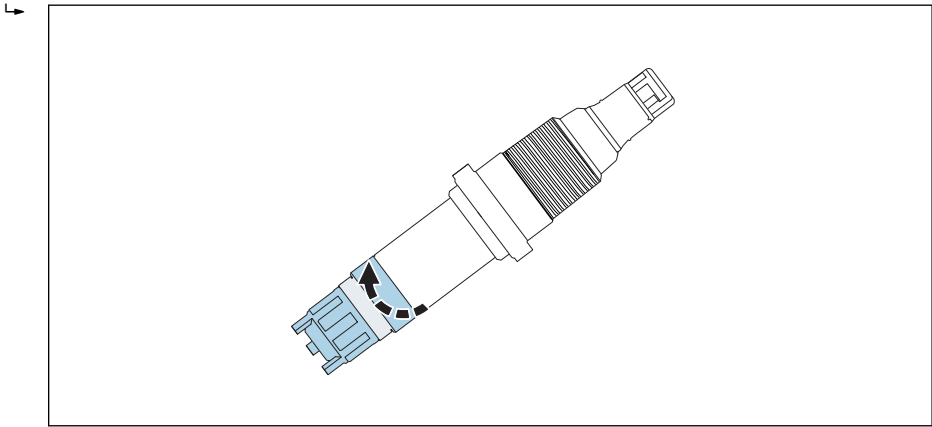

A0037888

 11 Carefully rotate membrane cap.

Screw membrane cap onto sensor

- ▶ Screw membrane cap onto sensor shaft: hold sensor by the shaft. Keep valve clear.

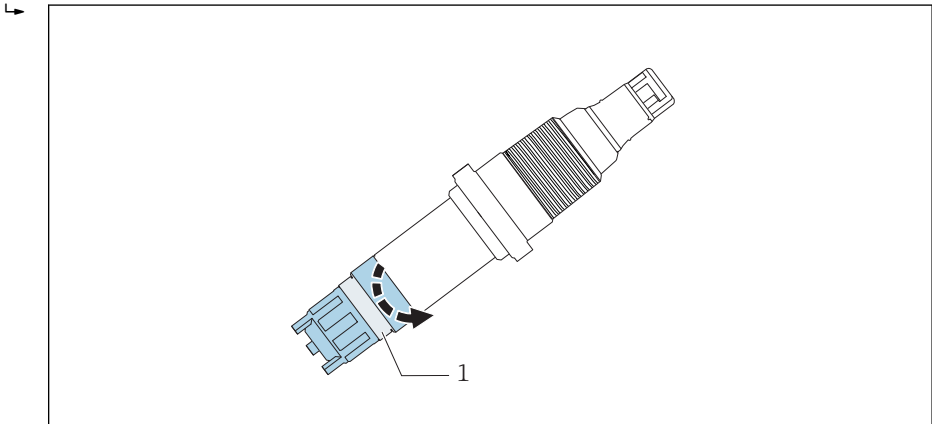

A0037889



 12 Screw on membrane cap: keep pressure relief valve clear.

1 Pressure relief valve

9.2.4 Storing the sensor

If measurement is suspended:

1. Remove sensor from assembly.
2. Unscrew membrane cap and dispose of it.

3. Rinse electrodes thoroughly with clean, warm water ensuring all residue of electrolyte is removed.
 4. Allow the electrodes to dry.
 5. Screw a new membrane cap loosely onto the electrodes to protect them.
 6. Fit protection cap on sensor →  31.
 7. For recommissioning, follow the same procedure as for commissioning →  24.
-  Ensure that no biofouling occurs during longer interruptions to measurement. Remove continuous organic deposits such as films of bacteria from media with a high concentration of chlorine.

Fitting the protection cap on the sensor

1. To keep the membrane moist after the sensor has been removed, fill the protection cap with clean water.

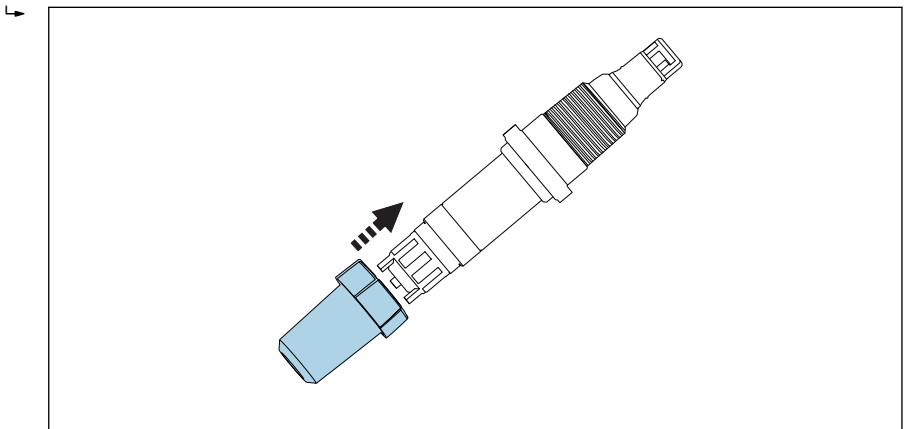

A0037886

 13 Carefully slide protection cap onto the membrane cap.

2. Top part of protection cap is in the open position.
Carefully slide protection cap onto the membrane cap.

- Secure protection cap by rotating the top part of the protection cap.

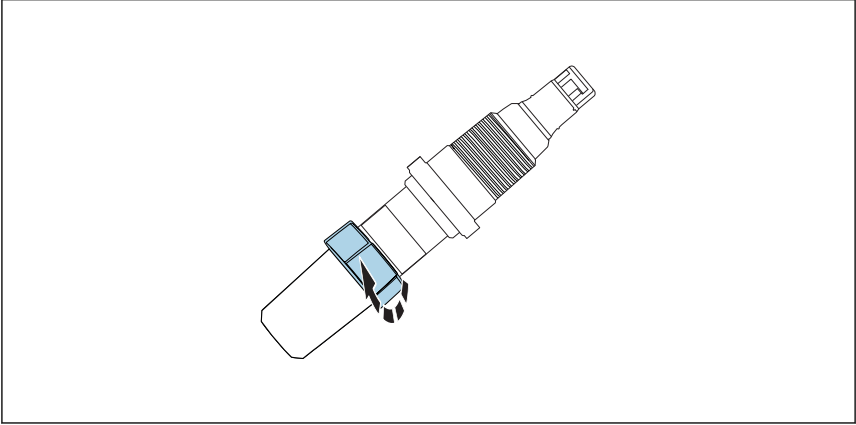

A0037887

 14 Securing protection cap by rotating the top part

9.2.5 Regenerating the sensor

During measurement, the electrolyte in the sensor is gradually exhausted due to chemical reactions. The gray-brown silver halide layer that is applied to the counter electrode at the factory continues to grow during sensor operation. However, this has no effect on the reaction taking place at the working electrode.

A change in the color of the silver halide layer indicates an effect of the reaction that is taking place. Carry out a visual inspection to ensure that the gray-brown color of the counter electrode has not changed. If the color of the counter electrode has changed, e.g. if it is spotted, white or silvery, the sensor must be regenerated.

- Send the sensor to the manufacturer for regeneration.

10 Repair

10.1 Spare parts

For more detailed information on spare parts kits, please refer to the "Spare Part Finding Tool" on the Internet:

www.endress.com/spareparts_consumables

10.2 Return

The product must be returned if repairs or a factory calibration are required, or if the wrong product was ordered or delivered. As an ISO-certified company and also due to legal regulations, Endress+Hauser is obliged to follow certain procedures when handling any returned products that have been in contact with medium.

To ensure the swift, safe and professional return of the device:

- ▶ Refer to the website www.endress.com/support/return-material for information on the procedure and conditions for returning devices.

10.3 Disposal

The device contains electronic components. The product must be disposed of as electronic waste.

- ▶ Observe the local regulations.

11 Accessories

The following are the most important accessories available at the time this documentation was issued.

- ▶ For accessories not listed here, please contact your Service or Sales Center.

11.1 Device-specific accessories

Kit CCS120/120D, maintenance kit

- 2 x membrane caps and 1 x electrolyte 50 ml (1.69 fl.oz)
- Order number: 71412917

Kit CCS120/120D, electrolyte

- 1 × electrolyte 50 ml (1.69 fl.oz)
- Order number: 71412916

Kit CCS120/120D, Viton ring set

- 2 × Viton rings
- Order number: 71105209

Memosens data cable CYK10

- For digital sensors with Memosens technology
- Product Configurator on the product page: www.endress.com/cyk10



Technical Information TI00118C

Memosens data cable CYK11

- Extension cable for digital sensors with Memosens protocol
- Product Configurator on the product page: www.endress.com/cyk11



Technical Information TI00118C

Memosens laboratory cable CYK20

- For digital sensors with Memosens technology
- Product Configurator on the product page: www.endress.com/cyk20

Flowfit CCA250

- Flow assembly for disinfection and pH/ORP sensors
- Product Configurator on the product page: www.endress.com/cca250



Technical Information TI00062C

Flexdip CYA112

- Immersion assembly for water and wastewater
- Modular assembly system for sensors in open basins, channels and tanks
- Material: PVC or stainless steel
- Product Configurator on the product page: www.endress.com/cya112



Technical Information TI00432C

Photometer PF-3

- Compact hand-held photometer for determining the reference measured value
- Color-coded reagent bottles with clear dosing instructions
- Order No.: 71257946

COY8

Zero-point gel for oxygen and disinfection sensors

- Oxygen-free and chlorine-free gel for the verification, zero point calibration and adjustment of oxygen and disinfection measuring points
- Product Configurator on the product page: www.endress.com/coy8



Technical Information TI01244C

12 Technical data

12.1 Input

12.1.1 Measured variables

Total chlorine

[mg/l, µg/l, ppm, ppb]

- Free available chlorine:
 - Hypochlorous acid (HOCl)
 - Hypochlorite ions (OCl⁻)
- Combined chlorine (chloramines)
- Organically combined chlorine (e.g. cyanuric acid derivatives)

Temperature

[°C, °F]

12.1.2 Measuring ranges

0.1 to 10 mg/l (ppm)

The sensor is not suitable for checking the absence of chlorine.

12.1.3 Signal current

2.4 to 5.4 nA per 1 mg/l (ppm)

12.2 Performance characteristics

12.2.1 Reference operating conditions

Temperature	30 °C (86 °F)
pH value	pH 7.2

12.2.2 Response time

T₉₀ approx. 60 s (with increasing and decreasing concentration)

12.2.3 Measured value resolution of sensor

0.01 mg/l (ppm)

12.2.4 Maximum measured error

±2 % or 200 µg/l (ppb) of value measured (depending on which value is higher)

LOD (limit of detection) ¹⁾	LOQ (limit of quantification) ¹⁾
0.022 mg/l (ppm)	0.072 mg/l (ppm)

1) Based on ISO 15839. The measured error includes all the uncertainties of the sensor and transmitter (electrode system). It does not contain all the uncertainties caused by the reference material and adjustments that may have been performed.

12.2.5 Repeatability

0.008 mg/l (ppm)

12.2.6 Nominal slope

4 nA per 1 mg/l (ppm) (under reference operating conditions)

12.2.7 Long-term drift

< ±3 % per month

12.2.8 Polarization time

Initial commissioning	Up to 24 h
After replacing the membrane cap	Typically 1 to 6 h
Recommissioning	Pour approx. 4 to 24 h

12.2.9 Operating time of the electrolyte

3 to 6 months (depending on water quality)

12.2.10 Operating time of membrane cap

With electrolyte	Typically 3 to 6 months, depending on water quality
Without electrolyte	> 2 years (25 °C (77 °F))

12.3 Environment

12.3.1 Ambient temperature range

5 to 45 °C (41 to 113 °F), no temperature fluctuations

12.3.2 Storage temperature

Without electrolyte

-20 to 60 °C (-4 to 140 °F)

12.3.3 Degree of protection

IP68

12.4 Process

12.4.1 Process temperature

5 to 45 °C (41 to 113 °F), no temperature fluctuations

12.4.2 Process pressure

max. 1 bar (14.5 psi) absolute, if installed in the Flowfit CCA250 assembly

12.4.3 pH range

pH5.5 to 9.5

pH dependency: increase from pH 7 to pH 8: approx. -10 % for free chlorine

12.4.4 Conductivity range

0.03 to 40 mS/cm

12.4.5 Flow

CCA250

- Optimum 40 to 60 l/h (10.6 to 15.8 gal/h)
- Minimum 30 l/h (7.9 gal/h)
- Maximum 100 l/h (26.4 gal/h)

12.4.6 Flow

- Optimum 20 to 30 cm/s
- Minimum 15 cm/s
- Maximum 50 cm/s

12.5 Mechanical construction

12.5.1 Dimensions

→  15

12.5.2 Weight

75 g (2.65 oz)

12.5.3 Materials

Sensor shaft	PVC
Membrane	PET
Membrane cap	PPE
Clamping ring	PTFE
Hose seal	Silicone
Electrode body	PMMA

12.5.4 Cable specification

max. 100 m (330 ft), incl. Cable extension

13 Installation and operation in hazardous environment Class I Div. 2

Non-sparking device for use in specified hazardous environment in accordance with:

- cCSAus Class I Div. 2
- Gas group A, B, C, D
- Temperature class T6, $-5\text{ °C (23 °F)} < T_a < 55\text{ °C (131 °F)}$
- Control drawing: 401204

Hazardous location
NI Class I, Division 2, Groups A, B, C, D T4A

XM442
XM444
XM448

x ... C or 0 or 0C

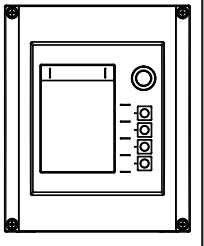

XM442R
XM444R
(with external Class I, Div. 2 certified power supply)
XM448R
(with external Class I, Div. 2 certified power supply)

x ... C or 0 or 0C

Non hazardous location

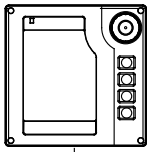

Prior to use the external cabinet (7185295) must be installed at the cabinet door.

The CL 1, Div. 2 display cabinet (7185295) may be connected to all CL 1, Div. 2 transmitters XM44xR.

Power supply 100... 230 V AC or 24 V AC/DC
Relay 230 V AC or 24 V DC

Digital/ analog input/output 0/4 mA... 20 mA Communication (Ethernet/ Fieldbus/ RS485)

Fixed cable sensors with Memorex protocol, max. cable length 100 m (330 ft), including Class II (intrinsically safe) and the following sensor types: CUS50 (humidity)

Note: Installation shall be in accordance with the NEC/CEC/ULX-1003.

THIS APPARATUS IS SUITABLE FOR USE IN CLASS 1, DIVISION 2, GROUPS A, B, C, D OR UNCLASSIFIED LOCATIONS.

WARNING: EXPLOSION HAZARD - SUBSTITUTION OF COMPONENTS MAY IMPAIR SUITABILITY FOR USE IN CLASS 1 DIVISION 2. AVERTISSEMENT: RISQUE D'EXPLOSION - LA SUBSTITUTION DES COMPOSANTS PEUT ENDRE CE MATERIEL INACCEPTABLE POUR LES EMPLACEMENTS DE CLASSE 1 DIVISION 2.

WARNING: EXPLOSION HAZARD - DO NOT DISCONNECT EQUIPMENT UNLESS POWER HAS BEEN SWITCHED OFF. AVERTISSEMENT: RISQUE D'EXPLOSION - AVANT DE RECONNECTER L'EQUIPEMENT, COUPER LE COURANT OU S'ASSURER QUE L'EMPLACEMENT EST DESIGNÉ NON DANGEREUX.

WARNING: EXPOSURE TO SOME CHEMICALS MAY DEGRADE THE SEALING PROPERTIES OF MATERIALS USED IN THE FOLLOWING DEVICES: Power Relay Tadmira 5208-K.

DO NOT SERVICE ELECTRICAL EQUIPMENT UNLESS IT HAS BEEN DISCONNECTED FROM THE AREA. THIS AREA IS KNOWN TO BE FREE OF IGNITIBLE CONCENTRATIONS OF FLAMMABLE GASES OR VAPORS.

THE DEVICE MUST BE INSTALLED IN A SUITABLE CABINET OR ENCLOSURE ELECTRICALLY ISOLATED FROM THE AREA. L'INSTRUMENT DOIT ÊTRE INSTALLÉ DANS UN BOÎTIER OU UNE ARMOIRE AVEC UNE CLÉ.

Refer to protection notice ISD_46096 Internal

The Classification
Control Drawing XM44x (R)
Control Drawing XM44x (R)

Scale: —

Watt. no.	10422
Drawing date	2018-08-22 Date H.
Number of changes	0
Welding contr.	—
Shims	—
Pressure contr.	—
Version	4.01204
Doc. part	J
Release	2018-08-27 Baumgartner

Project: —

Material: —

Weight: 4.01204

Volume: —

SNP internal no.: 71114711

Formal: A3

Page: 1 of 1



Index

A

- Accessories 34
- Ambient temperature range 37

C

- Cable specification 38
- Check
 - Connection 23
 - Function 24
 - Installation 22
- Cleaning 28
- Connection
 - Check 23
 - Ensuring the degree of protection 23

D

- Declaration of Conformity 13
- Degree of protection
 - Ensuring 23
 - Technical data 37
- Designated use 6
- Device description 8
- Diagnostics 26
- Disposal 33

E

- Effect on the measured signal
 - Flow 9
 - pH value 9
 - Temperature 10
- Electrical connection 22
- Environment 37
- Ex approvals 13

F

- Flow 9, 37
- Flow assembly 21
- Function check 24

I

- Immersion assembly 22
- Incoming acceptance 12
- Installation
 - Check 22
 - Flow assembly 21

- Immersion assembly 22
- Installation position 14
- Sensor 16
- Installation position 14

L

- Long-term drift 36

M

- Maintenance schedule 28
- Maintenance tasks 28
- Materials 38
- Maximum measured error 36
- Measured signal 9
- Measured value resolution 36
- Measured variables 35
- Measuring principle 8
- Measuring ranges 35
- Measuring system 16
- Mounting instructions 14

N

- Nameplate 12
- Nominal slope 36

O

- Operating principle 8
- Operating time of the electrolyte 36

P

- Performance characteristics 36
- pH range 37
- pH value 9
- Polarization time 36
- Post-installation check 24
- Process 37
- Process pressure 37
- Process temperature 37

R

- Reference operating conditions 36
- Regeneration 32
- Repair 33
- Repeatability 36
- Response time 36
- Return 33

S

Safety instructions	6
Scope of delivery	13
Sensor	
Calibration	24
Cleaning	28
Connecting	23
Mounting	16
Polarization	24
Regenerating	32
Storage	30
Spare parts	33
Storage	30
Storage temperature	37
Symbols	4

T

Technical data	
Environment	37
Input	35
Mechanical construction	37
Performance characteristics	36
Process	37
Temperature	10
Troubleshooting	26

U

Use	6
---------------	---

W

Warnings	4
Weight	37



71461435

www.addresses.endress.com
