

BENCHMIKE PRO **NEW**



The Industry's leading
off-line ID/OD/Wall
measurement system



- ▶ More gauges installed worldwide than all other manufacturers combined
- ▶ Measure manufactured cut samples fast and with the highest accuracy in the industry
- ▶ Perform reliable, non-contact measurements from run to run
- ▶ Benefit from easy-to-use features for simple setup and operation
- ▶ Get powerful Ethernet connectivity, communication and control capabilities



The Industry's Most Accurate, Reliable and Easiest-To-Use Gauging System Is Even Better

Non-contact laser technology, unsurpassed accuracy, and a compact design that allows it to fit almost anywhere have made the Beta LaserMike BenchMike gauge the industry's leading off-line ID/OD/Wall measurement system. Today, more than 15,000 manufacturing applications worldwide count on BenchMike's $\pm 0.9 \mu\text{m}$ accuracy and $\pm 0.25 \mu\text{m}$ repeatability to help them deliver the superior-quality products their customers demand.

The new **BenchMike Pro** gauge system continues this tradition. In the lab or on the plant floor, the BenchMike Pro's range of new connectivity, communication, and control features increases its performance capabilities to deliver exceptional accuracy, reliability, and ease of use in the most challenging measurement applications. Ready for service under Industry 4.0, BenchMike Pro offers:

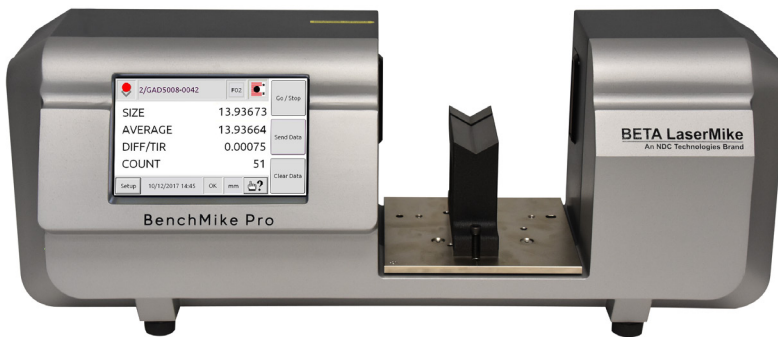

- ▶ **Expanded connectivity options** – Ethernet and USB – that simplify integrating BenchMike Pro into centralized production networks. This new platform lays the foundation for future connection via WiFi.
- ▶ **Faster communications processing** for more efficient data logging and sharing...improved production reporting and analysis...and increased quality control.
- ▶ **More I/O connections** featuring additional USB resources to provide greater flexibility in connecting BenchMike Pro to computers, data gathering devices, and USB printers that support the CUPS protocol.
- ▶ **Larger, higher-resolution touch-screen display** for easier viewing of critical measurement information and more intelligent production decisions.
- ▶ **Transparent object measurement** allowing BenchMike Pro to measure the diameter of transparent material, such as clear plastic products.
- ▶ **Advanced laser diode technology** doubles the lifetime of conventional diodes, providing the longest service life in the industry – greater than 5 years!

No Field Calibration Required

BenchMike Pro uses a combination of built-in auto-calibration and dual-differentiation technology providing unmatched accuracy without field calibration. Never has it been easier to incorporate precision measurement on the production line, and since every system includes a programmable RS-232C interface, collecting and sending data to your storage and control system is almost effortless.

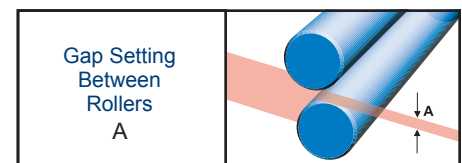
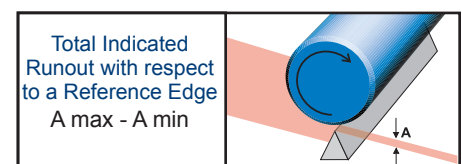
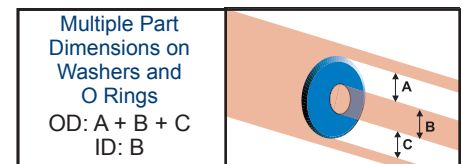
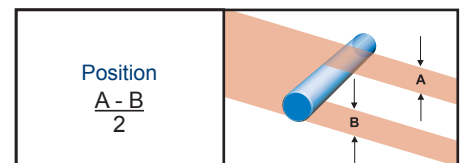
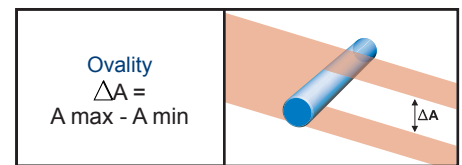
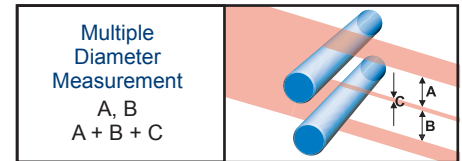
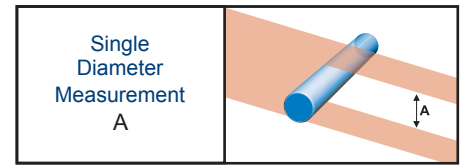

Simple Touch-Screen Interface Lets You Easily Access BenchMike Features and Functions

The BenchMike Pro's touch-screen graphical user interface (GUI) gives operators a quick and simple means of viewing dimensional measurements, accessing gauge and system information, and changing parts. Screen layouts are customized for the needs of the user or application and the "look and feel" is simple for any user familiar with Windows.

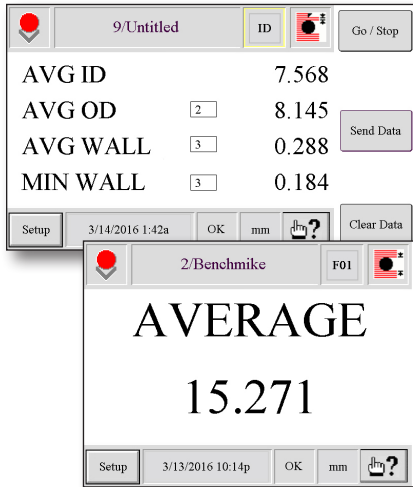

Data Display:

BenchMike Pro has advanced display capabilities allowing you to display measurement data, access menus to configure BenchMike Pro, and display general information such as presence or absence of error conditions.

Magnified Display

Magnify measurement items on the screen for visibility from a distance.

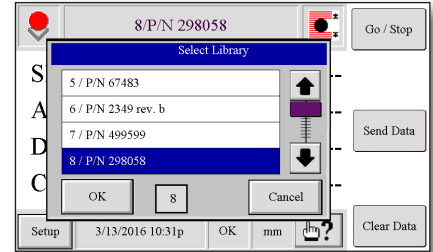

Library (Part) Selection

Use BenchMike libraries to store and recall how the measurements are to be taken, and manage other system setup information via separate libraries. By defining libraries for each product or for different fixtures, you can shorten set-up times for various parts or applications.

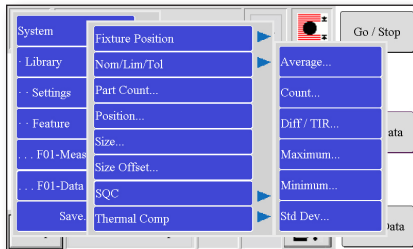

Pop-Up Menus

Quickly, easily access BenchMike features and functions via clear pop-up menus.

Rotational Cross-Section Display

When using a rotary ID/OD/Wall fixture, create a rotary graph that displays the size, position, and minimum and maximum data for measurements taken at multiple points around the product.

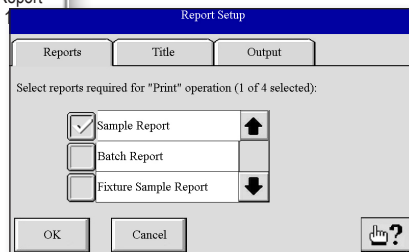
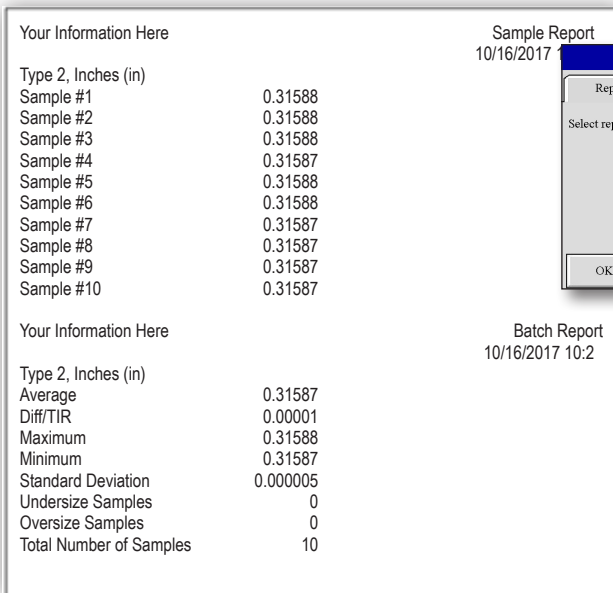
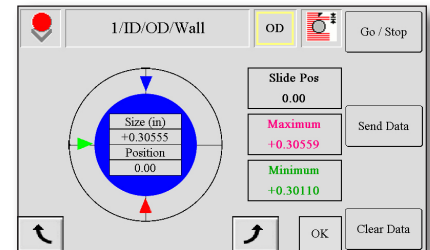

Robust Reporting

Easily generate Sample, Batch, and Fixture reports. Use the Sample Report when taking a single measurement of multiple parts. Use the Batch report to summarize statistical results for all measured parts. Use the Fixture reports to generate similar sample and batch details when using automated part-positioning fixtures.

Solutions for Pipe & Tube Applications

Pipe and tube manufacturers must ensure that the dimensions of their products are maintained within tight specifications to ensure the quality of the product and the profitability of the company. BenchMike Pro is the ideal solution for fast, simple, and accurate measurements of cut samples of extruded pipe and tube. BenchMike Pro is used worldwide on extrusion plant floors and quality control (QC) laboratories to give operators and technicians immediate feedback of product dimensions.

BenchMike Pro utilizes the latest in laser gauging technology to provide high-precision OD measurements of pipe and tube within specifications of less than 1µm (0.00004 in.). It is also engineered with the best edge detection technology on the market that is traceable to national standards (NIST).

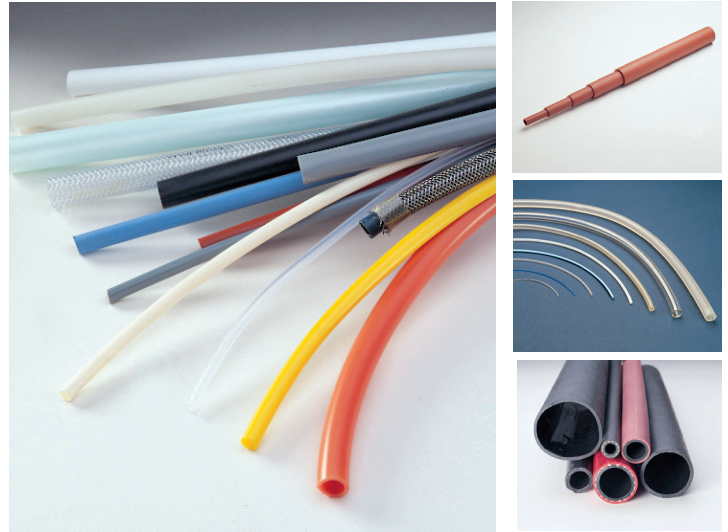

Diameter & Ovality Measurements

OD Measurement

For precision OD measurements, simply place your pipe or tube sample on the V-block fixture and BenchMike will instantly measure it. Using the V-block and BenchMike, an operator can measure dozens of parts per minute and with a much higher level of accuracy than any other method available for sample inspection. And with the use of laser technology, the measurements will be repeatable from one operator to another.

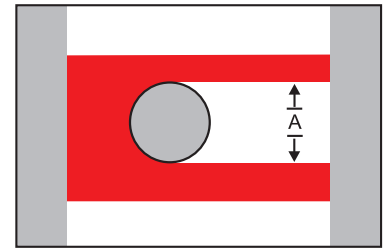

Single Diameter Measurement
OD = A

ID/OD/Wall Measurement

For precision ID, OD, and wall thickness measurements, simply place a pipe or tube sample on the ID/OD/Wall fixture and BenchMike will calculate all of the dimensions. The ID/OD/Wall fixture can also automatically rotate a sample to a pre-defined number of positions for measurements at multiple points around the product. This rotation also allows for the calculation of concentricity and ovality of the product. The graphical user interface has options to view the rotational cross section of the product and a graph that shows deviation or variation at the various rotational degrees of measurement.

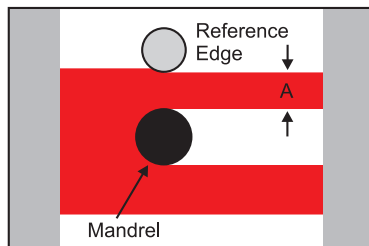
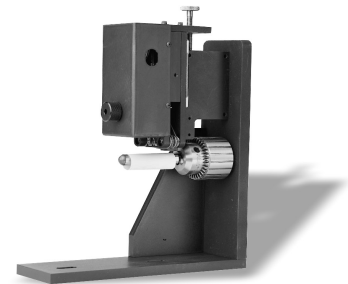

Step 1: Master on reference edge and mandrel

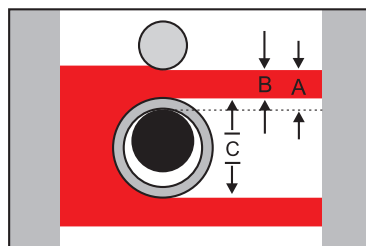

Step 2: Place product on mandrel and take measurements
 $Wall = A - B$ $OD = C$
 $ID = OD - (2 \times Wall)$

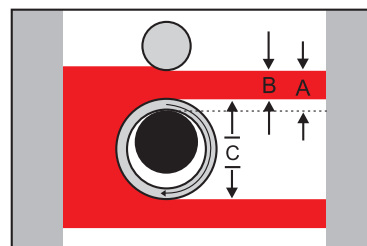

Step 3: Rotate the product to attain multiple points of measurement as well as concentricity and ovality
 $Concentricity = \Delta(A - B)$
 $Ovality = \Delta C$

Specifications

Measurement Specifications

	Model 2025	Model 2050
Measurement Range ¹	0.100 to 25.4 mm (0.004 to 1.0 in.)	0.254 to 50 mm (0.010 to 2.0 in.)
Repeatability ²	±0.25 µm (0.000010 in.)	±0.5 µm (0.000020 in.)
Linearity	±0.9 µm (±0.000036 in.)	±1.5 µm (±0.000060 in.)
Measurement Area Depth Of Field	±.75 x 25 mm (±0.030 x 1.0 in.)	±1.5 x 50 mm (±0.060 x 2.0 in.)
Laser Beam Velocity	50 m/sec. (2,000 in./sec.)	100 m/sec. (4,000 in./sec.)
Temperature Coefficient	<0.2 µm/°C (<0.000004 in./°F)	
Calibration	Factory calibrated	
Scan Rate	100/sec	

¹For ID/OD/Wall applications, maximum OD is dependent on product.

²Accuracy of ID/OD/Wall measurement is dependent on product.

*See other sizes in the Options section.

General Specifications

Operating Temperature	7° to 36°C (45° to 97°F) at < 90% relative humidity
Storage Temperature	-20° to 60°C (-4° to 140°F)
Dimensions (H x W x D)	254 x 635 x 228 mm (10 x 25 x 9 in.)
Weight	19.7 kg (43 lb.)
LaserSource	Collimated diode; <1 mW output
Display	177.8 mm (7 in.) capacitive touch
Power Requirements	100 to 240 volts AC (+5% to -10%), 50/60 Hz (±2 Hz) 100 watts total power

Input/Output

BenchMike Pro provides a variety of input/output connectors to allow flexible integration with other devices.

- ▶ Two serial ports – DB9 and USB – to link with computers or data gathering devices
- ▶ USB port compatible with most inkjet printers that support the CUPS protocol
- ▶ Ethernet port for network connection to facilitate easy data access and sharing
- ▶ Digital I/O port for connection of alarm outputs to indicate out-of-tolerance conditions and other errors, as well as digital inputs to activate functions remotely
- ▶ Fixture port for connection to intelligent fixtures capable of moving and rotating the test pieces
- ▶ Scan output BNC port for diagnostic access to the laser scan signal













Modular Fixtures

Ready-To-Mount Flexibility

We offer an extensive line of ready-to-mount modular fixtures from simple manual fixtures to fully automatic and intelligent fixtures. These fixtures hold workpieces properly and effectively for any gauging need. Simply attach these easy-to-install fixtures to your BenchMike Pro for precise, reliable measurements without calibration.

We provide a full line of heavy-duty fixtures to measure small and large parts, along with automatic motorized fixtures for part translation and rotation. For your custom needs, our Special Engineering group excels at developing fixtures for special applications.

	Fixture	Description	Part #
	V-Block: General Purpose, Fixed	Used for measuring parts positioned on their outside diameter. Holds diameters from 0.38 to 45.72 mm (0.015 to 1.800 in.).	83855 (283-10) 83854 (283-20)
	V-Block: General Purpose, Full-Range, Adjustable	Enables part centering and measurement over the full measuring range of the BenchMike Series. Holds diameters from 0.38 to 50.4 mm (0.015 to 2.0 in.).	83976
	V-Block: Adjustable	Supports parts that must be held on their outside diameters. Must be mounted on a slide. Holds wire diameters up to 45 mm (1.8 in.).	83609
	V-Block: General Purpose Adjustable	Designed for fine wire or other material that must be centered for best measurement accuracy. Holds wire diameters from 0.025 to 10.16 mm (0.001 to 0.400 in.).	84260
	Slide: Universal Manual	Used to linearly position parts by hand. Available in 457, 635 or 829 mm (18, 25 or 32 in.) lengths. Slide travel is 305, 483, or 660 mm (12, 19, or 26 in.).	83610 (457 mm) 83611 (635 mm) 83618 (829 mm)
	Slide: Digital Readout	Used to linearly position parts to predetermined positions for measurement and/or measure the distance between two points on a part. Available in 457, 635 or 829 mm (18, 25 or 32 in.) lengths. Slide travel is 305, 483, or 660 mm (12, 19, or 26 in.).	83616 (457 mm) 83617 (635 mm) 83863 (829 mm)
	ID/OD/Wall: Small Tube & Hose, Auto-Rotating	Automatically rotates enabling inside diameter, outside diameter, and wall thickness measurements of small tubular products such as medical tubing, hose, and glass. Can be supplied with a Force Gauge for measuring very small tubes.	84019 Force Gauge: GA5005-0013 (see next page)
	ID/OD/Wall: Tube & Hose, Manual	Enables inside diameter, outside diameter, and wall thickness measurement of tubular products such as medical tubing, hose, and glass.	83921
	ID/OD/Wall: Large Tube & Hose, Auto-Rotating	Enables the inside diameter, outside diameter, and wall thickness measurement of large, heavy tubular products such as metal tube, hose, and glass.	84291
	Chuck: Auto-Rotating	Motorized rotation of shafts or wires to detect variation in diameter around the circumference. Keyless precision chuck holds diameters 0.003 to 1.5 in. (75µm to 38 mm).	84007 (Zero) 84005 (1/8 in.) 84015 (1/2 in.) 84022 (1.5 in.)

Modular Fixtures, cont.

Force Gauge (GA5005-0013)

For precision ID, OD, and Wall Thickness measurements on thin-wall small diameter tubing, such as medical tubing, simply place a tube sample on the ID/OD/Wall fixture, apply the desired force on the sample, and BenchMike will calculate all the dimensions.



Other Measurement and Control Solutions

In addition to our BenchMike Pro off-line gauging system, we offer a complete portfolio of measurement and control solutions for on-line production applications. Our solutions enable manufacturers to realize a number of performance and production benefits, such as improved product quality, enhanced process reliability, increased productivity, and reduced manufacturing costs.



AccuScan
High-Speed Diameter and Ovality Measurement Systems

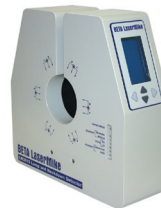

LN Detectors
Lump and Neckdown Measurement Systems

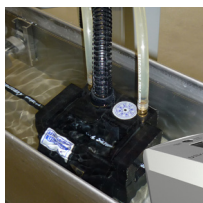

UltraScan Pro
Wall and Concentricity Measurement Systems

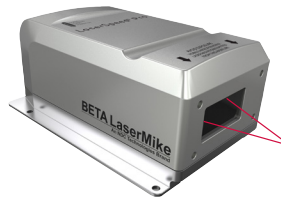

LaserSpeed Pro
Non-Contact Length and Speed Measurement Systems



InControl
Process Control and Data Management Systems

Precision Measurement & Control Solutions

The Beta LaserMike line of measurement and control solutions from NDC Technologies is designed to increase productivity, improve product quality, and reduce manufacturing costs. These solutions provide in-process dimensional monitoring, control, and sample/part inspection of products such as wire and cable, fiber optics, metals, rubber and plastic, flat rolled goods and tube and pipe to name a few. Every system is backed by NDC's world-class service and support organization. With offices around the globe, we're committed to serving your unique measurement application needs.



NDC Technologies is represented in over 60 countries worldwide. www.betalasermike.com

a spectris company

NDC Americas

Tel: +1 937 233 9935
Email: sales@betalasermike.com

NDC China

Tel: +86 21 6113 3617
Email: sales@betalasermike.com

NDC India

Tel: +91 124 2789507
Email: sales@betalasermike.com

NDC Europe

Tel: +44 1621 852244
Email: sales@betalasermike.com

NDC SE Asia

Tel: +65 91994120
Email: sales@betalasermike.com



In line with its policy of continuous improvement, NDC reserves the right to revise or replace its products or services without prior notice. The information contained in this document may not represent the latest specification and is for indicative purposes only.

Document #: T-BROC-SCAN-BenchMike Pro PT-EN-2018JAN23
Date of Issue: January 2018
© NDC Technologies 2018

BENCHMIKE PRO **NEW**



The Industry's leading
off-line diameter & ovality
measurement system



- ▶ Industry's leading sample inspection system
- ▶ Measure manufactured cut samples fast and with the highest accuracy in the industry
- ▶ Perform reliable, non-contact measurements from run to run
- ▶ Benefit from easy-to-use features for simple setup and operation
- ▶ Get powerful Ethernet connectivity, communication and control capabilities

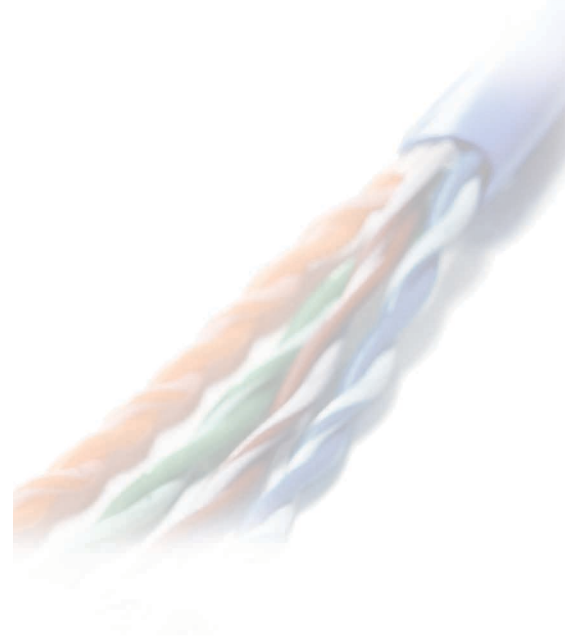

The Industry's Most Accurate, Reliable and Easiest-To-Use Gauging System Is Even Better

Non-contact laser technology, unsurpassed accuracy, and a compact design that allows it to fit almost anywhere have made the Beta LaserMike BenchMike gauge the industry's leading off-line diameter and ovality measurement system. Today, more than 15,000 manufacturing applications worldwide count on BenchMike's $\pm 0.9 \mu\text{m}$ accuracy and $\pm 0.25 \mu\text{m}$ repeatability to help them deliver the superior-quality products their customers demand.

The new **BenchMike Pro** gauge system continues this tradition. In the lab or on the plant floor, the BenchMike Pro's range of new connectivity, communication, and control features increases its performance capabilities to deliver exceptional accuracy, reliability, and ease of use in the most challenging measurement applications. Ready for service under Industry 4.0, BenchMike Pro offers:

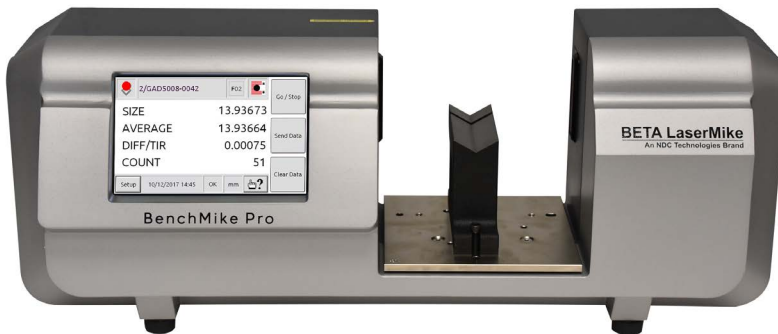

- ▶ **Expanded connectivity options** – Ethernet and USB – that simplify integrating BenchMike Pro into centralized production networks. This new platform lays the foundation for future connection via WiFi.
- ▶ **Faster communications processing** for more efficient data logging and sharing...improved production reporting and analysis...and increased quality control.
- ▶ **More I/O connections** featuring additional USB resources to provide greater flexibility in connecting BenchMike Pro to computers, data gathering devices, and USB printers that support the CUPS protocol.
- ▶ **Larger, higher-resolution touch-screen display** for easier viewing of critical measurement information and more intelligent production decisions.
- ▶ **2-Year product warranty**

Maintain Consistent Accuracy and Repeatability

BenchMike Pro uses auto-compensation features to maintain accuracy throughout the entire measurement range and adjusts for thermal expansion outside laboratory environments. Never has it been easier to incorporate precision measurement on the production line, and since every system includes a programmable RS-232C interface, collecting and sending data to your storage and control system is almost effortless.

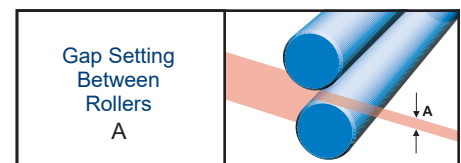
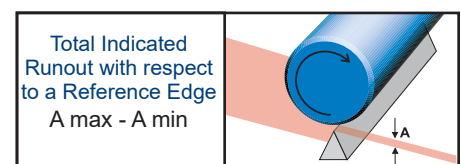
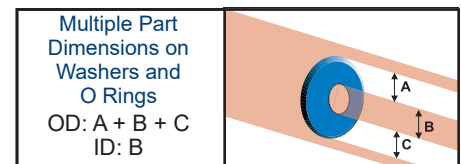
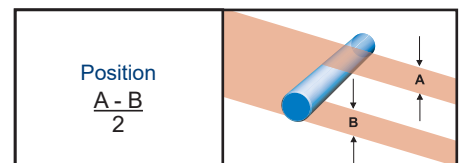
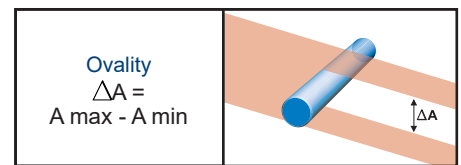
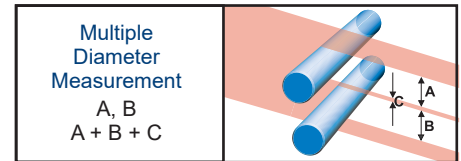
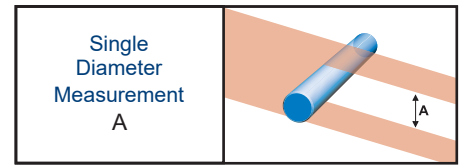

Simple Touch-Screen Interface Lets You Easily Access BenchMike Features and Functions

The BenchMike Pro's touch-screen graphical user interface (GUI) gives operators a quick and simple means of viewing dimensional measurements, accessing gauge and system information, and changing parts. Screen layouts are customized for the needs of the user or application and the "look and feel" is simple for any user familiar with Windows.



Data Display:

BenchMike Pro has advanced display capabilities allowing you to display measurement data, access menus to configure BenchMike Pro, and display general information such as presence or absence of error conditions.



Magnified Display

Magnify measurement items on the screen for visibility from a distance.

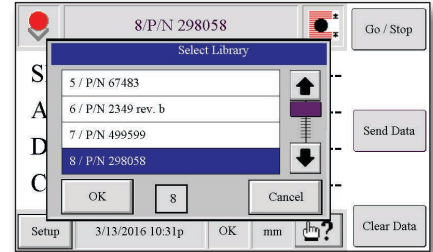

Library (Part) Selection

Use BenchMike libraries to store and recall how the measurements are to be taken, and manage other system setup information via separate libraries. By defining libraries for each product or for different fixtures, you can shorten set-up times for various parts or applications.

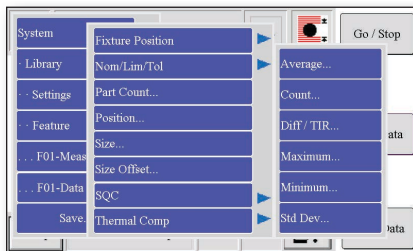

Pop-Up Menus

Quickly, easily access BenchMike features and functions via clear pop-up menus.

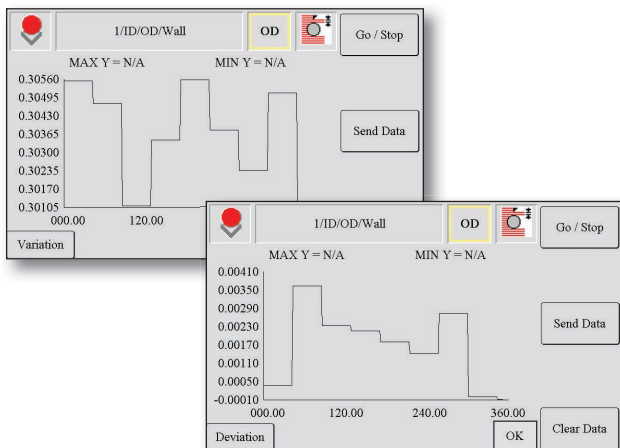

Rotational Deviation/Variation Graphs

Create Deviation and Variation graphs when using an intelligent fixture. The graphs show the deviation from nominal at each position and size variation between positions.

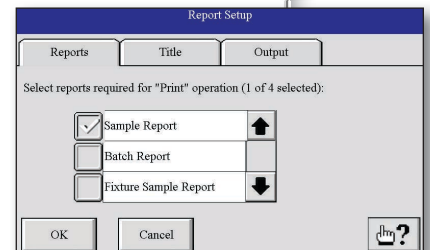
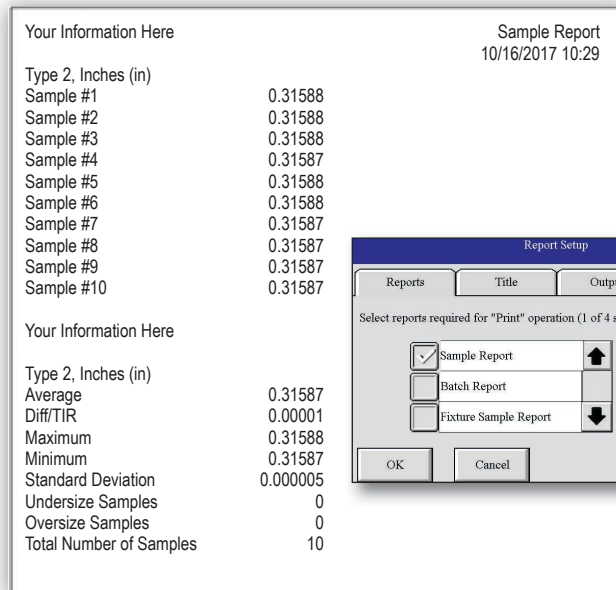

Robust Reporting

Easily generate Sample, Batch, and Fixture reports. Use the Sample Report when taking a single measurement of multiple parts. Use the Batch report to summarize statistical results for all measured parts. Use the Fixture reports to generate similar sample and batch details when using automated part-positioning fixtures.

Solutions for Wire & Cable Applications

Wire and cable manufacturers must ensure that the dimensions of their products are maintained within tight specifications to ensure the quality of the product and the profitability of the company. BenchMike Pro is the ideal solution for fast, simple, and accurate measurements of cut samples of extruded wire and cable. BenchMike Pro is used worldwide on extrusion plant floors and quality control (QC) laboratories to give operators and technicians immediate feedback of product dimensions.

BenchMike Pro utilizes the latest in laser gauging technology to provide high-precision OD measurements of wire and cable within specifications of less than $1\mu\text{m}$ (0.00004 in.). It is also engineered with the best edge detection technology on the market that is traceable to national standards (NIST).

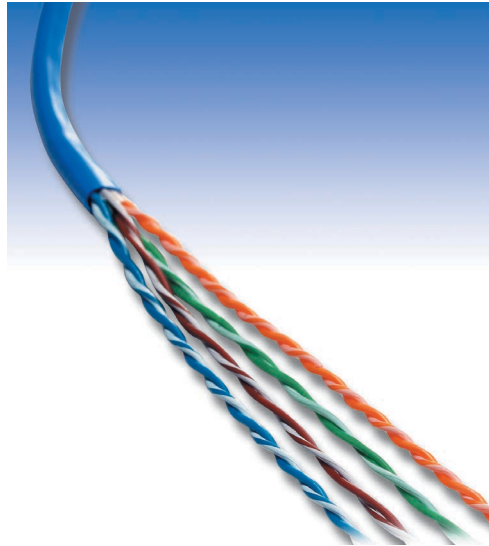

Diameter & Ovality Measurement

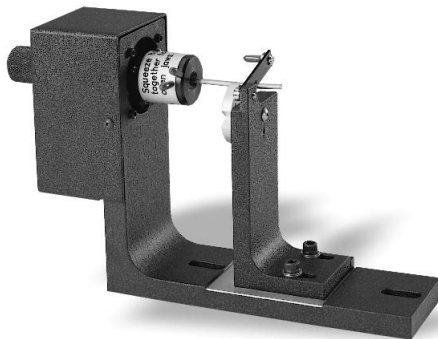

<< Auto-Rotating Chuck Fixture

For precision OD measurements, simply place your product in the rotary chuck fixture and BenchMike Pro will instantly measure it. Using BenchMike Pro, an operator can measure dozens of parts per minute and with a much higher level of accuracy than any other method available for sample inspection. And with the use of laser technology, the measurements will be repeatable from one operator to another.

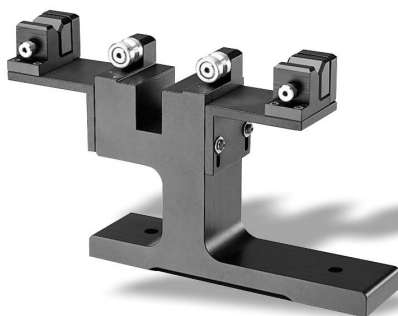

<< Ultra Fine Wire V-Block

Ultra Fine Wire V-Block is designed for ultra fine wire or other material that must be held under tension for accurate measurement. Holds wires in the range of 0.025 to 0.254 mm (0.001 to 0.010 in.). It is used with Small Spot Size Option.

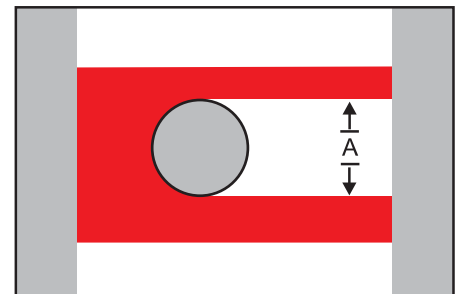

Single Diameter Measurement
OD = A

Specifications

Measurement Specifications

	Model 2025	Model 2050
Measurement Range*	0.100 to 25.4 mm (0.004 to 1.0 in.)	0.254 to 50 mm (0.010 to 2.0 in.)
Repeatability	±0.25 µm (0.000010 in.)	±0.5 µm (0.000020 in.)
Accuracy	±0.9 µm (±0.000036 in.)	±1.5 µm (±0.000060 in.)
Measurement Area Depth Of Field	±.75 x 25 mm (±0.030 x 1.0 in.)	±1.5 x 50 mm (±0.060 x 2.0 in.)
Laser Beam Velocity	50 m/sec. (2,000 in./sec.)	100 m/sec. (4,000 in./sec.)
Temperature Coefficient	<0.2 µm/°C (<0.000004 in./°F)	
Calibration	Factory calibrated	
Scan Rate	100/sec	

*See other sizes in the Options section.

General Specifications

Operating Temperature	7° to 36°C (45° to 97°F) at < 90% relative humidity
Storage Temperature	-20° to 60°C (-4° to 140°F)
Dimensions (H x W x D)	254 x 635 x 228 mm (10 x 25 x 9 in.)
Weight	19.7 kg (43 lb.)
LaserSource	HeNe gas laser; <1 mW output
Display	177.8 mm (7 in.) capacitive touch
Language Support	German, French, Spanish and Chinese
Power Requirements	100 to 240 volts AC (+5% to -10%), 50/60 Hz (±2 Hz) 100 watts total power
Product Warranty	2 years

Input/Output

BenchMike Pro provides a variety of input/output connectors to allow flexible integration with other devices.

- ▶ Two serial ports – DB9 and USB – to link with computers or data gathering devices
- ▶ USB port compatible with most inkjet printers that support the CUPS protocol
- ▶ Ethernet port for network connection to facilitate easy data access and sharing
- ▶ Digital I/O port for connection of alarm outputs to indicate out-of-tolerance conditions and other errors, as well as digital inputs to activate functions remotely
- ▶ Fixture port for connection to intelligent fixtures capable of moving and rotating the test pieces
- ▶ Scan output BNC port for diagnostic access to the laser scan signal















Modular Fixtures

Ready-To-Mount Flexibility

We offer an extensive line of ready-to-mount modular fixtures from simple manual fixtures to fully automatic and intelligent fixtures. These fixtures hold workpieces properly and effectively for any gauging need. Simply attach these easy-to-install fixtures to your BenchMike Pro for precise, reliable measurements without calibration.

We provide a full line of heavy-duty fixtures to measure small and large parts, along with automatic motorized fixtures for part translation and rotation. For your custom needs, our Special Engineering group excels at developing fixtures for special applications.

	Fixture	Description	Part #
	V-Block: General Purpose, Fixed	Used for measuring parts positioned on their outside diameter. Holds diameters from 0.38 to 45.72 mm (0.015 to 1.800 in.).	83855 (283-10) 83854 (283-20)
	V-Block: General Purpose, Full-Range, Adjustable	Enables part centering and measurement over the full measuring range of the BenchMike Series. Holds diameters from 0.38 to 50.4 mm (0.015 to 2.0 in.).	83976
	V-Block: Adjustable	Supports parts that must be held on their outside diameters. Must be mounted on a slide. Holds wire diameters up to 45 mm (1.8 in.).	83609
	V-Block: Fine Wire Adjustable	Designed for fine wire or other material that must be centered for best measurement accuracy. Holds wire diameters from 0.025 to 10.16 mm (0.001 to 0.400 in.).	84260
	V-Block: Ultra Fine Wire	Designed for ultra fine wire or other material that must be held under tension for accurate measurement. Holds wire diameters from 0.025 to 0.254 mm (0.001 to 0.010 in.). Used with Small Spot Size Option.	84252
	Slide: Universal Manual	Used to linearly position parts by hand. Available in 457, 635 or 829 mm (18, 25 or 32 in.) lengths. Slide travel is 305, 483, or 660 mm (12, 19, or 26 in.).	83610 (457 mm) 83611 (635 mm) 83618 (829 mm)
	Slide: Digital Readout	Used to linearly position parts to predetermined positions for measurement and/or measure the distance between two points on a part. Available in 457, 635 or 829 mm (18, 25 or 32 in.) lengths. Slide travel is 305, 483, or 660 mm (12, 19, or 26 in.).	83616 (457 mm) 83617 (635 mm) 83863 (829 mm)
	Chuck: Auto-Rotating	Motorized rotation of shafts or wires to detect variation in diameter around the circumference. Keyless precision chuck holds diameters 0.76 to 12.7 mm (0.030 to 0.50 in.).	84015
	Chuck: Zero-Rotating	Enables the automatic measurement of diameter variation from 75 µm to 3 mm (0.003 to 0.120 in.).	84007
	Chuck: 3.18 mm Rotating	Enables the automatic measurement of diameter variation from 0.3 to 3.18 mm (0.012 to 0.125 in.).	84005
	Chuck: 38 mm Rotating	Enables the automatic measurement of diameter variation from 1.5 to 38 mm (0.0625 to 1.5 in.).	84022
	Wire Auto-Rotating	Designed for the automatic measurement of very small diameter samples from 0.075 to 1.27 mm (0.003 to 0.050 in.). Used with Small Spot Size Option.	84274 (English) 84495 (Metric)
	Fine Wire Heanium V-Guide	Enables the measurement of small samples that will not lay straight in a V-block. Holds wire diameters from 0.076 to 3.175 mm (0.003 to 0.125 in.). Used with Small Spot Size Option.	83883

Option

Special accessories are available to address certain non-standard applications or data needs.

► **Small Spot Size Option**

Special measurement range from 25 μm (0.001 in.) to 10 mm (0.4 in.) (factory installed option)

Other Measurement and Control Solutions

In addition to our BenchMike Pro off-line gauging system, we offer a complete portfolio of measurement and control solutions for on-line production applications. Our solutions enable manufacturers to realize a number of performance and production benefits, such as improved product quality, enhanced process reliability, increased productivity, and reduced manufacturing costs.



AccuScan
*High-Speed Diameter and Ovality
Measurement Systems*



InControl/DataPro
*Process Control and
Data Management Systems*



UltraScan Pro
*Wall and Concentricity
Measurement Systems*

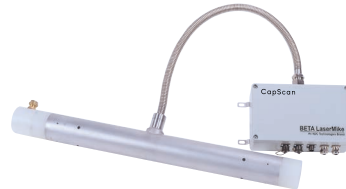

CapScan
*Capacitance Measurement
Systems*



Fault Detection
*- Lump and Neckdown
Measurement Systems*



CenterScan
*Non-Contact Eccentricity
Measurement System*

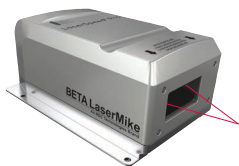

LaserSpeed Pro
*Non-Contact Length and Speed
Measurement Systems*



Preheater
Wire Preheating Systems



LayScan
Lay Length Measurement System

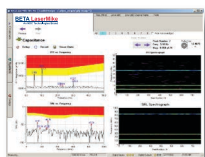

SRL Pro
*On-Line Structural Return Loss
Prediction*

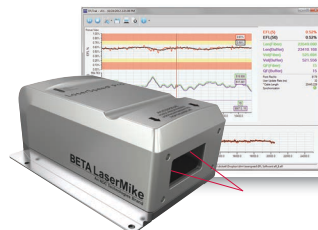

EFL Pro
*Excess Fiber Length
Measurement System*

Precision Measurement & Control Solutions

The Beta LaserMike line of measurement and control solutions from NDC Technologies is designed to increase productivity, improve product quality, and reduce manufacturing costs. These solutions provide in-process dimensional monitoring, control, and sample/part inspection of products such as wire and cable, fiber optics, metals, rubber and plastic, flat rolled goods and tube and pipe to name a few. Every system is backed by NDC's world-class service and support organization. With offices around the globe, we're committed to serving your unique measurement application needs.



NDC Technologies is represented in over 60 countries worldwide. www.ndc.com/betalasermike

NDC Americas

Tel: +1 937 233 9935
Email: info@ndc.com

NDC China

Tel: +86 21 6113 3609
Email: ndchina@ndc.com

NDC Germany

Tel: 08001123194
Email: ndcgermany@ndc.com

NDC Singapore

Tel: +65 91994120
Email: ndcapac@ndc.com

NDC South Korea

Tel: +82 (10) 40682926
Email: ndcapac@ndc.com

NDC United Kingdom

Tel: +44 1621 852244
Email: ndcuk@ndc.com

NDC Japan

Tel: +81 3 3255 8157
Email: ndcjapan@ndc.com

NDC Italy

Tel: +39 0331 454 207
Email: ndcitaly@ndc.com

NDC India

Tel: +91 9890800697
Email: ndcindia@ndc.com

In line with its policy of continuous improvement, NDC reserves the right to revise or replace its products or services without prior notice. The information contained in this document may not represent the latest specification and is for indicative purposes only.

Document #: C-BROC-SCAN-BenchMike Pro WC-EN-2020SEPT18
Date of Issue: September 2020
© NDC Technologies 2020