

BenchMike Pro

Benchtop Laser Micrometer

Instruction Handbook



Proprietary Notice

The information and design disclosed herein were originated by and are the property of NDC Technologies. NDC Technologies reserves all patent, proprietary design, manufacturing, reproduction use, and sales rights thereto, and to any article disclosed therein, except to the extent rights are expressly granted to others. The foregoing does not apply to vendor proprietary parts.

In-line with NDC's policy of continuous improvement, the information contained in this document may change to allow the introduction of design improvements.

BenchMike Pro Instruction Handbook

Part Number: MAN/EN5008-0092

Revision: E

Language: English

Date of Release: May, 2019

Contact NDC

Online Support

You can access the NDC Customer Support portal, **myNDC** at <https://ndc.custhelp.com>.

myNDC is a cloud-based portal that allows you to get product support by phone, ask a question, provide feedback, submit an RMA request or access information in our on-line knowledge database. You can browse the myNDC site or create a myNDC account.

- To create a myNDC account, click the **Log in or Sign up** button. After creating the account, you will be immediately logged in. To log in on subsequent visits to myNDC, click the **Log in or Sign up** button, enter your user name and password, and then click **Log in**.
- To submit an RMA, click on the **RMA Request** tab and follow the on-screen instructions.

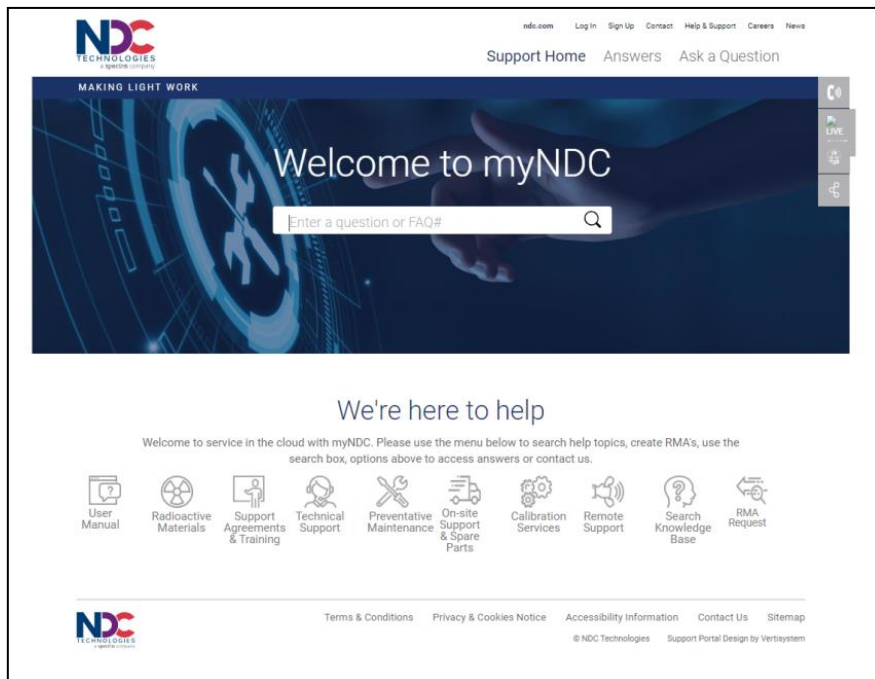

NDC Contact Numbers by Product Type

Please have your sales order number at hand before contacting NDC.

- NDC Systems including Infrared, Xray and Nucleonic Sensors

	NDC Systems: including Infrared, Xray and Nucleonic Sensors
Americas	+1 626 939 3855
Asia Pacific	Japan: +81 (0)3 3255 8157
	All other countries: +44 1621 852244 Select option 3 to be connected to the service team
China	+86 21 61133609
EMEA (Europe, Middle East, Africa)	Germany: 0800 1123194
	France: 0810 600 400
	Italy: +39 0331 454 207
	All other countries (English speaking): +44 1621 852244 Please select option 3 to be connected to the service team

– **Beta LaserMike Gauges**

	Beta LaserMike Gauges
Americas	+1 937 233 9935
Asia Pacific	India: +91-124-2789507 Alternative number +91-124-2789508
	Japan: +81 (0)3 3255 8157
	All other countries: +1 937 233 9935 Alternative number +44 1621 852244
China	+86 21 61133609
EMEA (Europe, Middle East, Africa)	Germany: 0800 1123194
	France: 0810 600 400
	Italy: +39 0331 454 207
	All other countries (English speaking): +44 1621 852244 Please select option 3 to be connected to the service team

– **NDC Metals Systems, including AccuRay and IRM brands**

	NDC Metals Systems: including AccuRay and IRM brands
Americas	North America: +1 626 939 3855
	South America: +32 4 239 90 10
Asia Pacific	+32 4 239 90 10
China	+86 21 61133609
EMEA (Europe, Middle East, Africa)	+32 4 239 90 10

Caution

- This equipment must be earthed/grounded.
- Under NO circumstances should the earth safety connections be broken – internal damage to sensitive electronic components may occur and at worst electrocution to personnel may result.
- Digital outputs are open - collector outputs, with maximum specs of 35 V DC and 250ma. These levels must not be exceeded.
- Maintenance, repairs and electrical connections should be performed by a suitably qualified person for the country of installation.
- The equipment contains a slow blow type fuse to protect against input power overloads and is not user replaceable.

Intended Use

If the equipment is used in a manner not specified by the manufacturer, the protection provided by the equipment may be impaired.

Laser Safety Precautions

The BenchMike Pro uses a Collimated Diode laser which emits red light at a wavelength of 635nm. No invisible or otherwise harmful radiation is emitted.

The radiant output power of either internal laser (whether it be a laser diode or gas laser) and of the entire BenchMike Pro is relatively low. The laser beam will not harm your skin, and your eyes are protected by a natural aversion response that will cause you to blink or look away. However, the laser light emitted from the BenchMike Pro should be treated with caution and common sense. Do not attempt to look into the BenchMike Pro, and avoid staring at reflections of the beam.

The American National Standard for the Safe Use of Lasers (ANSI Z136.1 — 2014) classifies this laser product as Low Power — Class II and provides reasonable and adequate guides for its safe use. The user of the BenchMike Pro and other personnel responsible for its safe use should consult this ANSI standard. It is available from:

American National Standards Institute
1430 Broadway
New York, New York 10018

The Center for Devices and Radiological Health (CDRH) of the Food and Drug Administration has established regulations for manufacturers of laser products. All laser products sold in the U.S.A. since August, 1976 must be certified by the manufacturer as meeting certain product performance (safety) standards, and each laser must bear a label indicating compliance with the standard and denoting laser hazard classification.

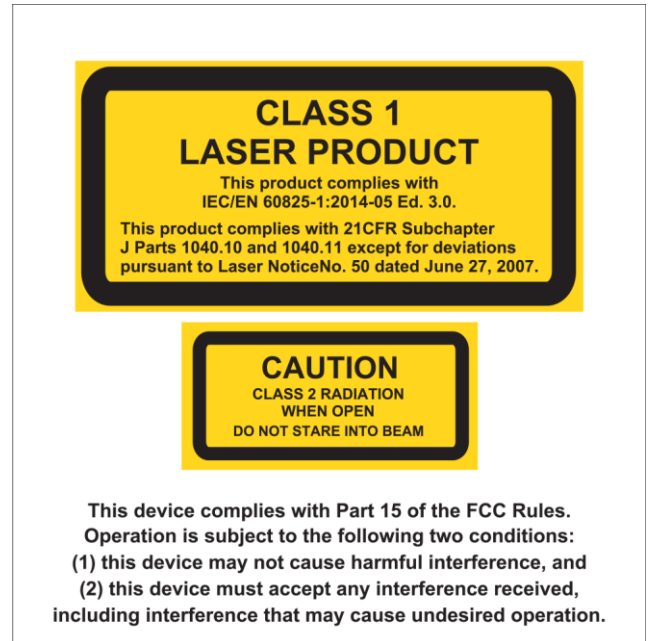

Labels and Safety Features

This section acquaints you with the advisory and identification labels on the instrument and the safety features incorporated into the design of the instrument. The following figures show the identification and advisory labels on the BenchMike Pro.

Front View

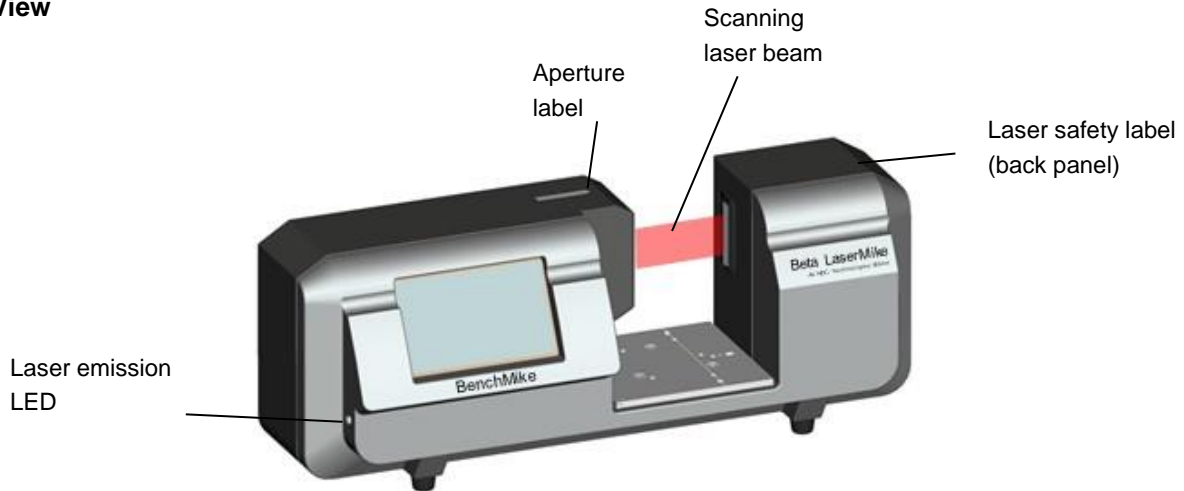

Model 2025

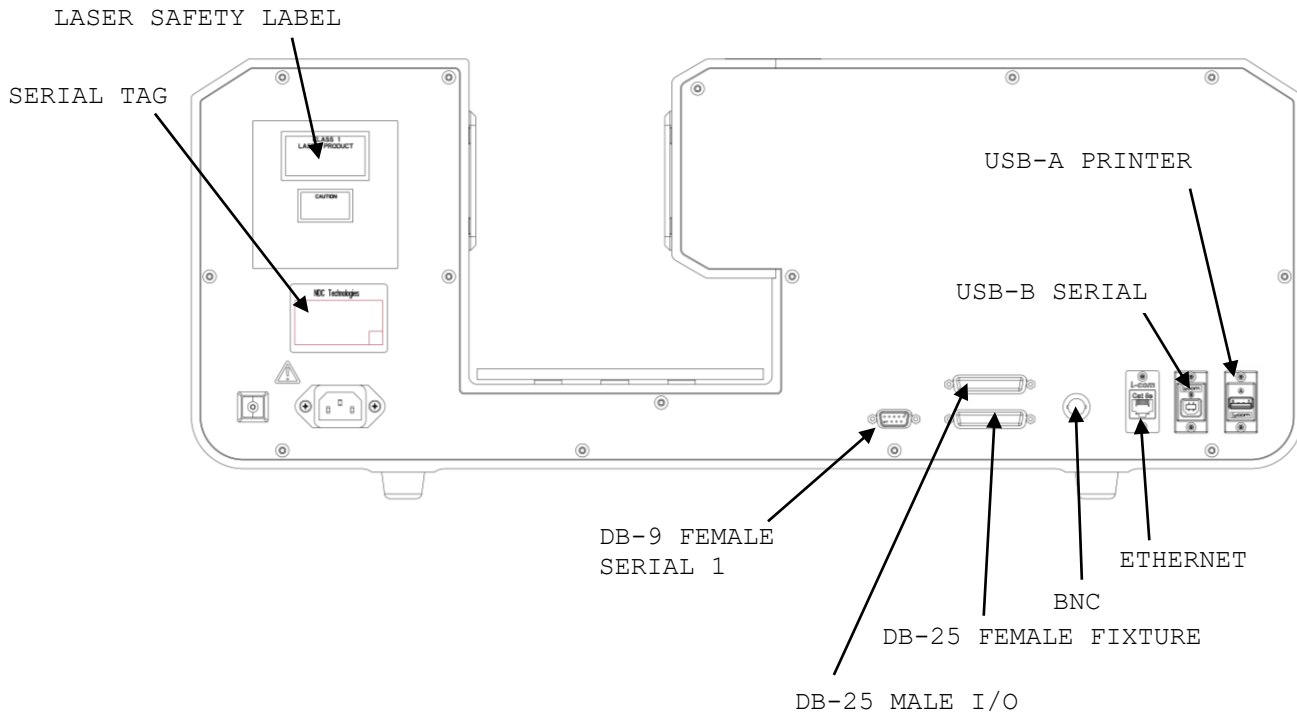

Model 2050

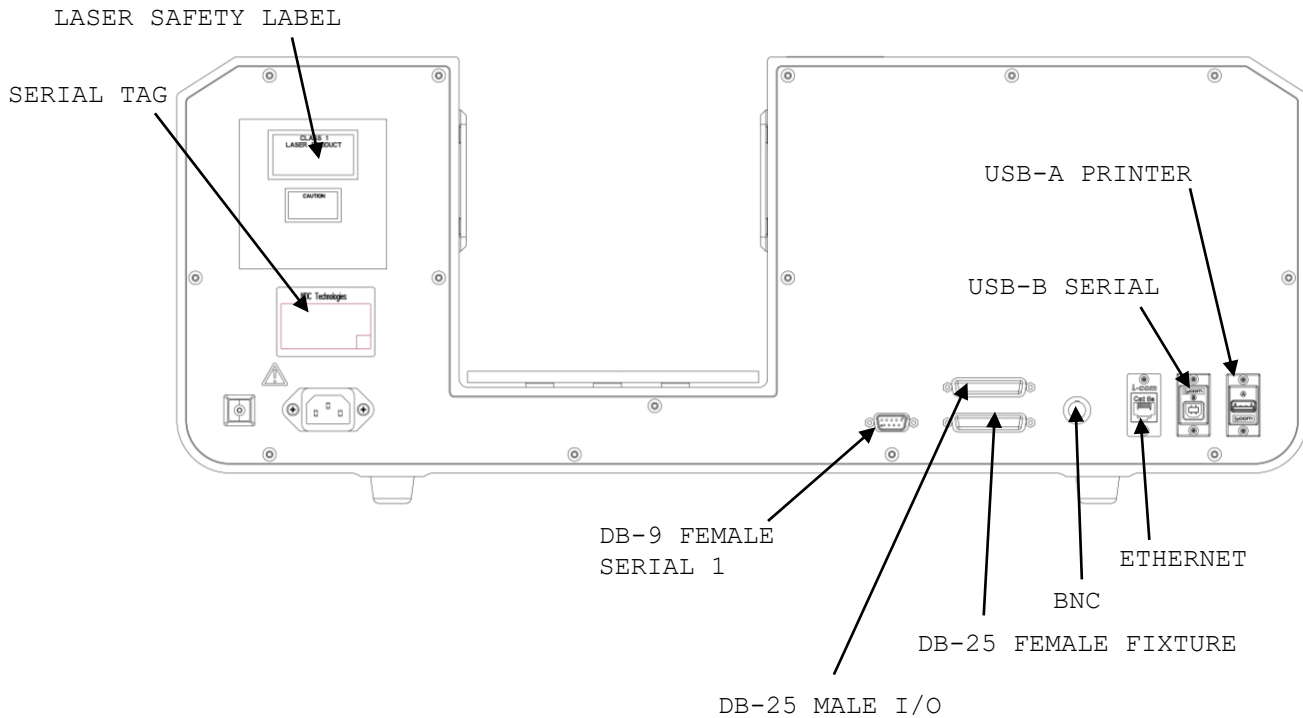

FCC Manual Digital Devices Statement

NOTE: This equipment has been tested and found to comply with the limits for a Class A digital device, pursuant to part 15 of the FCC Rules. These limits are designed to provide reasonable protection against harmful interference when the equipment is operated in a commercial environment. This equipment generates, uses, and can radiate radio frequency energy and, if not installed and used in accordance with the instruction manual, may cause harmful interference to radio communications. Operation of the equipment in a residential area is likely to cause harmful interference, in which case, the user will be required to correct the interference at his own expense.

Table of Contents

1	INTRODUCTION.....	1-1
1.1	INTRODUCTION.....	1-1
1.2	BENCHMIKE PRO OPTIONS.....	1-1
1.2.1	<i>Laser Beam Options</i>	1-1
1.2.2	<i>Interfaces</i>	1-1
1.2.3	<i>Accessories</i>	1-1
1.2.4	<i>Measurement Fixtures</i>	1-2
1.3	CALIBRATION.....	1-2
1.4	USING THE BENCHMIKE PRO.....	1-3
1.5	MEASURING A PRODUCT.....	1-3
1.5.1	<i>Sources of Error</i>	1-4
1.5.2	<i>Measuring Transparent Products</i>	1-5
1.6	DATA PROCESSING AND DISPLAY.....	1-6
1.7	LASER SAFETY.....	1-7
1.7.1	<i>Output Beam Data</i>	1-7
1.7.2	<i>Warning Information</i>	1-7
2	INSTALLATION.....	2-1
2.1	INSTRUCTIONS.....	2-1
2.1.1	<i>Power</i>	2-1
2.1.2	<i>Lifting</i>	2-1
2.1.3	<i>Location</i>	2-1
2.1.4	<i>Ventilation Requirements</i>	2-1
2.1.5	<i>Equipment Maintenance</i>	2-1
2.1.6	<i>Caution Symbol</i>	2-2
2.2	DRAWINGS.....	2-2
2.2.1	<i>BenchMike Pro Model 2025 Outline Drawing</i>	2-3
2.2.2	<i>BenchMike Pro Model 2025 Connector Drawing</i>	2-4
2.2.3	<i>BenchMike Pro Model 2050 Outline Drawing</i>	2-5
2.2.4	<i>BenchMike Pro Model 2050 Connector Drawing</i>	2-6
2.3	CONNECTIONS.....	2-7
2.3.1	<i>Connecting the BenchMike Pro to Your PC</i>	2-7
2.3.2	<i>Digital I/O Connector</i>	2-7
2.3.3	<i>Connecting to Digital Inputs</i>	2-9

2.3.4	Connecting to Digital Outputs with the BenchMike Pro +12V Supply	2-9
2.3.5	Connecting to Digital Outputs with an External Supply	2-10
2.3.6	Serial Connector	2-10
2.3.7	USB Printer Connector	2-11
2.3.8	USB Serial Connector	2-11
2.3.9	Ethernet RJ45 Connector	2-11
2.3.10	Fixture Connector	2-11
2.3.11	Connecting to a Quadrature Encoder	2-12
2.4	ADDING A NETWORK PRINTER	2-13
2.4.1	Requirements	2-13
2.4.2	Procedure	2-13
2.5	ADDING A USB PRINTER	2-23
2.5.1	Requirements	2-23
2.5.2	Procedure	2-23
3	WORKHOLDING FIXTURES	3-1
3.1	ERROR SIGNALS	3-1
3.2	INTELLIGENT AND NON-INTELLIGENT FIXTURES	3-1
3.2.1	Non-Intelligent Fixture: Linear (Slide) Position	3-1
3.2.2	Intelligent Fixture: Rotary/Linear Fixture Position	3-2
3.3	DESCRIPTION OF FIXTURES	3-2
3.3.1	General Purpose Fixed V-Block Fixture	3-2
3.3.2	Universal Slide Fixture	3-3
3.3.3	Digital Readout (DRO) Slide Fixture	3-7
4	SETUP	4-1
4.1	SETTING UP THE BENCHMIKE PRO	4-1
4.1.1	Turning Power On	4-1
4.1.2	Using the Three Data Buttons	4-1
4.1.3	Touch Screen Layout	4-1
4.2	MODE ICON AND MENU	4-4
4.3	FEATURE ICON	4-5
4.4	MEASUREMENT ICON	4-6
4.5	SETUP MENU	4-7
4.6	SYSTEM FUNCTIONS	4-7
4.6.1	Communication Ports	4-11
4.6.2	Sleep and Shutdown Functions	4-13
4.7	LIBRARY FUNCTIONS	4-14

4.8	SETTINGS FUNCTIONS.....	4-16
4.9	REPORTS	4-17
4.9.1	<i>Sample Report</i>	4-18
4.9.2	<i>Batch Report</i>	4-19
4.9.3	<i>Fixture Sample Report</i>	4-20
4.9.4	<i>Fixture Batch Report</i>	4-21
4.9.5	<i>Rotating Fixture Batch Report Data Flow</i>	4-22
4.9.6	<i>Serial Data Out Format</i>	4-23
4.9.7	<i>SQC Batch Setup</i>	4-24
4.9.8	<i>Environmental Compensation Setup</i>	4-24
4.9.9	<i>Units/Res/Rounding</i>	4-25
4.10	FEATURE FUNCTIONS.....	4-26
4.11	MEASUREMENT FUNCTIONS.....	4-28
4.11.1	<i>Expression Editor</i>	4-28
4.11.2	<i>Fixtures Menu</i>	4-28
4.11.3	<i>Measurement Type</i>	4-32
4.11.4	<i>Measurement Method</i>	4-34
4.11.5	<i>Averaging Mode</i>	4-34
4.11.6	<i>Custom Mode</i>	4-34
4.11.7	<i>Nominal/Limits/Tolerance Setup</i>	4-35
4.11.8	<i>Floating Nominal</i>	4-35
4.11.9	<i>Master Measurement</i>	4-36
4.12	DATA FUNCTIONS.....	4-37
4.13	SAVE FUNCTION.....	4-41
4.14	STATUS MENUS	4-42
4.15	SECURITY SETUP	4-45
4.15.1	<i>Entering the System Password</i>	4-46
4.15.2	<i>Security Page</i>	4-46
4.15.3	<i>Lock Page</i>	4-46
4.15.4	<i>Screen Configuration</i>	4-47
4.15.5	<i>Scanner Configuration</i>	4-47
4.15.6	<i>Scan Errors Configuration</i>	4-48
4.15.7	<i>International Configuration</i>	4-48
4.15.8	<i>Options 1: Reports</i>	4-48
4.15.9	<i>Options 2: Graphs</i>	4-49
5	ADVANCED CAPABILITIES.....	5-1

5.1	EXPRESSION EDITOR	5-1
5.1.1	<i>Components of the Expressions</i>	5-1
5.2	ADVANCED SCREEN CAPABILITIES	5-6
5.2.1	<i>Accessing Advanced Capabilities</i>	5-6
5.2.2	<i>Tolerance and Limit Checking Display Capabilities</i>	5-7
5.3	CUSTOM MEASUREMENTS	5-8
5.3.1	<i>Custom Measurement Properties</i>	5-10
5.4	USING A FOOTSWITCH	5-10
6	REMOTE SETUP	6-1
6.1	WHAT IS PURL?	6-1
6.1.1	<i>Non-Printable Characters</i>	6-1
6.2	COMMAND FORMAT	6-2
6.2.1	<i>Messages to the BenchMike Pro Without the Wrapper</i>	6-2
6.2.2	<i>Messages from the BenchMike Pro without the Wrapper</i>	6-3
6.2.3	<i>Messages to the BenchMike Pro with the Wrapper</i>	6-3
6.2.4	<i>Messages from the BenchMike Pro with the Wrapper</i>	6-4
6.2.5	<i>Prefix Setting</i>	6-9
6.3	COMMAND DESCRIPTIONS	6-10
6.3.1	<i>Configure Settings</i>	6-10
6.3.2	<i>Getting Help</i>	6-19
6.3.3	<i>Performing Measurements</i>	6-19
6.3.4	<i>Checking System Status and Configuring Libraries</i>	6-21
6.4	TABLE OF COMMANDS	6-24
7	SERVICING YOUR EQUIPMENT	7-1
8	SPECIFICATIONS	8-1
8.1	OPERATIONAL SPECIFICATIONS	8-1
8.2	PERFORMANCE SPECIFICATIONS	8-1
8.2.1	<i>General BenchMike Pro Specifications (2025 and 2050)</i>	8-2
8.2.2	<i>BenchMike Pro Model 2025 Specifications¹</i>	8-3
8.2.3	<i>BenchMike Pro Model 2050 Specifications¹</i>	8-3
8.3	DRAWINGS	8-4
8.3.1	<i>BenchMike Pro Model 2025</i>	8-4
8.3.2	<i>BenchMike Pro Model 2050</i>	8-5
8.4	LASER BEAM OPTIONS	8-5

1 Introduction

1.1 Introduction

This manual contains detailed information about the NDC Technologies BenchMike Pro Benchtop Laser Micrometers. This includes the following two models:

- BenchMike Pro Model 2025
- BenchMike Pro Model 2050

1.2 BenchMike Pro Options

The Model 2025 BenchMike Pro covers the measurement range 0.003-1.00 inch, and the Model 2050 BenchMike Pro covers the measurement range 0.010-2.00 in. There are five types of optional BenchMike Pro equipment.

1.2.1 Laser Beam Options

There are wide beam options for all BenchMike Pro models which permit the measurement of rough surfaces. A small spot size option is also available for the Model 2025 to measure small diameters and part features down to 0.001 inch (25.4 μm).

1.2.2 Interfaces

The following input and output interfaces are ordered as options to the standard BenchMike Pro, allowing you to customize your micrometer to your specific needs: 8 digital inputs and 12 digital outputs, 1 stepper motor port, a second quadrature encoder input, and footswitch input.

1.2.3 Accessories

Accessories to the BenchMike Pro include footswitch, and dust cover.

1.2.4 Measurement Fixtures

Work holding fixtures such as universal slides, v-blocks, adjustable centers, leadscrew positioners, rotary chucks, concentricity fixtures, and positioning tables are available for the BenchMike Pro, as described in the [Workholding Fixtures](#) section.

1.3 Calibration

Each BenchMike Pro is calibrated at the factory using specialized NDC Technologies equipment. This calibration is performed with N.I.S.T. (National Institute of Standards and Technology) traceable calibration gauges in an environmentally-controlled laboratory to ensure optimal performance.

Before a certificate of calibration is issued, each of the following procedures is performed at the factory:

- External optics are cleaned
- Internal optics are cleaned
- Multiple mastered points are used to enhance accuracy
- Test points and power supply voltages are verified
- Optics are aligned
- Scan-across test is performed to verify accuracy at several hundred points
- Repeatability test is performed to determine short-term measurement stability
- Drift test is performed to determine long-term measurement stability
- Multi-point performance test is performed with a V-block

In order to ensure the measurement accuracy shown in the [Specifications](#), it is recommended that you have your BenchMike Pro calibrated by NDC Technologies once per year. While at the factory, NDC Technologies can also perform any required retrofits, repairs, or upgrades.

1.4 Using the BenchMike Pro

To turn on the BenchMike Pro, push the power button on the rear of the unit. It will take about one minute for the unit to initialize.

To turn off the BenchMike Pro, push the power button for one second. The BenchMike Pro will begin the power-down cycle. Holding down the power button for five seconds will immediately turn off the unit.

When the BenchMike Pro is turned on, the last saved configuration is displayed on the touch screen. The graphical user interface includes a touch screen which allows the screen to be used to select items. Use your finger to select commands, menus, help, or enter numbers.

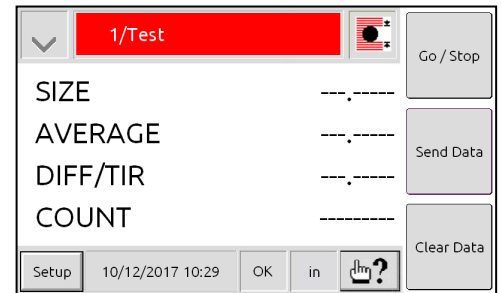

To avoid scratching the coating on the touch screen, do not use any sharp object on the display. Remember to clean the screen regularly, using a household window cleaner. Ensure that the lower rim of the screen is kept clean of dust and other contaminants to avoid degrading the gasket around the display.

1.5 Measuring a Product

The BenchMike Pro measures a part by sweeping a beam of laser light across its measurement area. Each sweep of the beam is called a scan. The BenchMike Pro scans the part 100 times per second.

As the beam sweeps through the BenchMike Pro's measurement area, it is alternately blocked by the part, or allowed to pass through to the receive side of the BenchMike Pro. This breaks each scan up into segments of light (when the beam passes over the product) and dark (when the beam is blocked by the product). The BenchMike Pro measures the diameter of a part by detecting the size of this "shadow" (dark segment) created by the part.

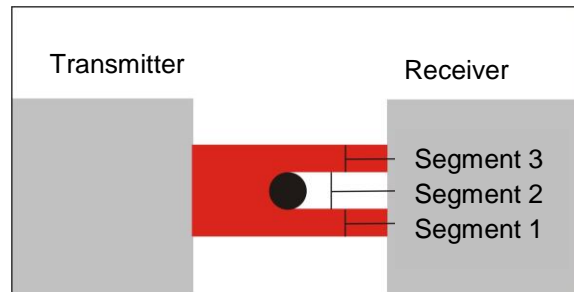

NOTE: The number of segments created by the laser beam will vary based on the number of part(s) placed in the measurement area.

In general, you can measure an object placed in the scanning laser beam if it creates a "shadow". However, to obtain maximum accuracy, a certain portion has been defined as the measurement area. This area represents the location where specifications apply and performance is consistent with factory calibration and alignment.

The measurement area surrounds the Pass Line of the gauge and covers of the full measurement range of the unit (1.0 in. for the Model 2025 and 2.0 in. for the Model 2050). The Pass Line of the gauge is located halfway between the transmitter and the receiver. These areas are defined as follows:

Model 2025: ± 0.030 in. from the Pass Line

Model 2050: ± 0.060 in. from the Pass Line

You will obtain the most accurate measurements from your BenchMike Pro when the part is placed in this area.

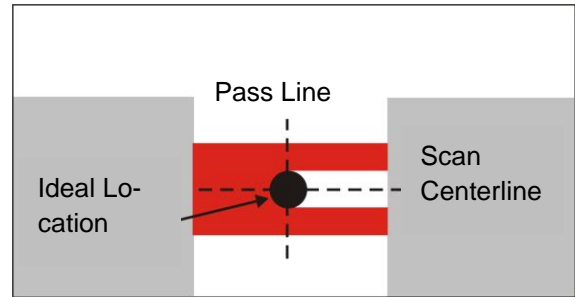

NOTE: Specifications apply at the intersection of the Scan Centerline and the Pass Line.

1.5.1 Sources of Error

Please note that any motion of the part, while in a fixture or not, can induce measurement error.

Be conscious of the following potential sources of error during measurement.

Dust or film on the measured object will produce measurements greater than the actual size. Wipe oily or dusty objects with a cloth before measuring them.

Dust or contamination on the transmitter or receiver scan window will also produce incorrect measurements. Follow the cleaning procedure described later in this manual as part of a routine maintenance program.

Incorrectly placing the object in the measurement area will also produce incorrect measurements. Place the measured object perpendicular to the scanning laser beam, and avoid tilting the measured object vertically with respect to the scan path. The greater the object's angle, the greater the measurement error.

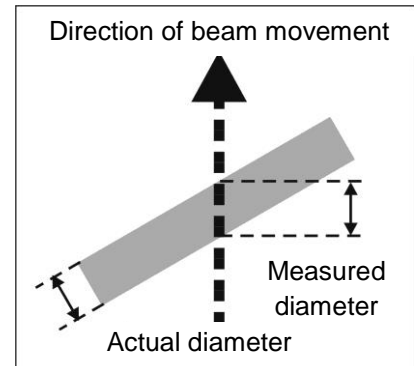

Temperature variations (see Troubleshooting section in the Operator Guide) will cause expansion or contraction of the part. Accurate temperature measurements are necessary to compensate for changes in product size.

As an object moves within the measurement area, certain errors will become more prominent, depending on the direction and magnitude of this motion. In general, measurements are less affected by motion along the Scan Centerline than by motion along the Pass Line.

1.5.2 Measuring Transparent Products

The BenchMike Pro can measure transparent products when a Transparent Object Measurement type (Types 51, 52, and 53) is selected. See section in Setup about [Measurement Types](#) for more information.

Although an opaque product blocks laser light across its entire diameter, a transparent product allows some laser light to pass through.

Since the BenchMike Pro determines product size based on the sharp increases and decreases in gathered laser light, it may incorrectly determine product diameter for transparent products unless Transparent Object Measurement types are selected.

The drawings to the right show sample oscilloscope waveforms from the measurement of an opaque product and a transparent product. For the opaque product, the BenchMike Pro can easily determine the width of the product since the waveform drops sharply and rises sharply at the edges of the product. For the transparent product, however, laser light passes through the product and the behavior of the light between the first sharp drop and last sharp rise must be ignored. With the Transparent Object Measurement type, the product diameter is based on the first sharp drop in laser light and the last sharp rise, resulting in a correct calculation of the diameter.

Note that having a clean product is essential for attaining an accurate measurement in these modes.

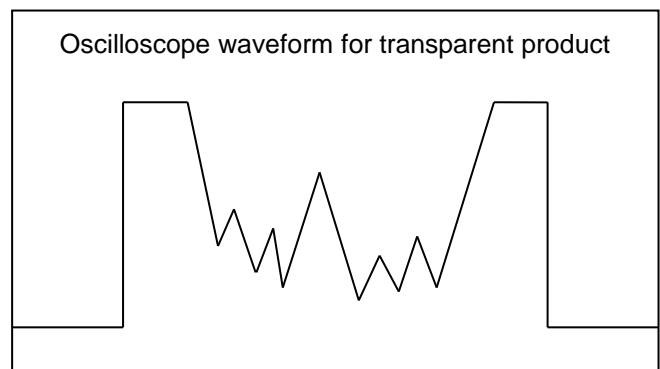
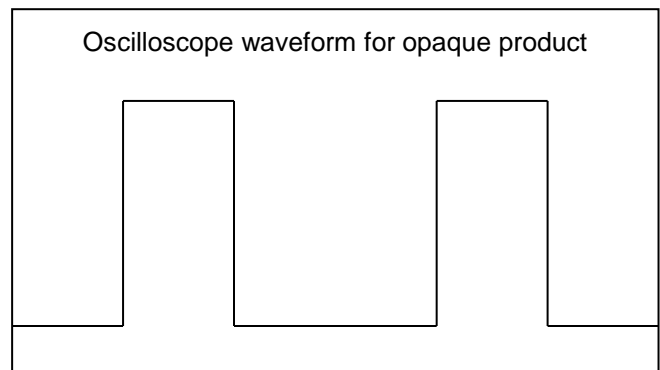
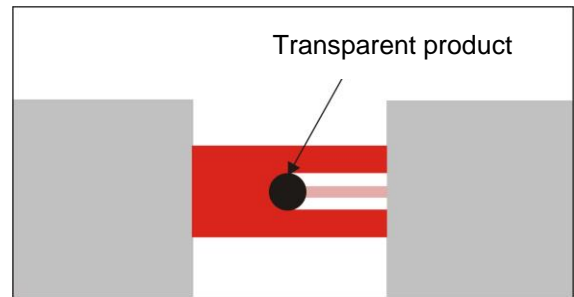

1.6 Data Processing and Display

The BenchMike Pro allows you great flexibility in controlling the way data is displayed and processed. As described in the [Advanced Capabilities](#) section, there are several parameters which can be used to control the averaging of measurements, the number of digits displayed on the screen, the format of printed reports, etc. The BenchMike Pro has been specifically designed to allow you to customize your measurement display and data processing simply and for your specific needs and preferences.

Each sweep of the laser beam across the measurement area is called a scan, and the BenchMike Pro scans the part 100 times per second. Scans are collected to compute a reading for a given sample. The Averaging Rate parameter determines how many scans (or time length in seconds) are averaged to compute one reading.

Although each scan received from the BenchMike Pro includes enough information to compute a size value, accuracy and repeatability are increased significantly if a number of scans are collected and averaged. Scans can be taken of individual samples or continuous products, as defined on the [Measurement Setup](#) page. For individual samples, an Averaging Rate value of 200 scans is typical. For continuous products, an appropriate value should be determined experimentally for the particular application.

The average of all the readings taken during a batch is calculated, along with the standard deviation. The standard deviation is a measure of how the individual sample values varied during the batch. The standard deviation value indicates whether samples were evenly distributed over a wide range of values or whether most samples were grouped around the average value. The diagram to the right shows two sample normal distributions.

The drawing to the right shows a normal distribution of data. A normal distribution is one in which 99.73% of all values fall within ± 3 standard deviations of the average.

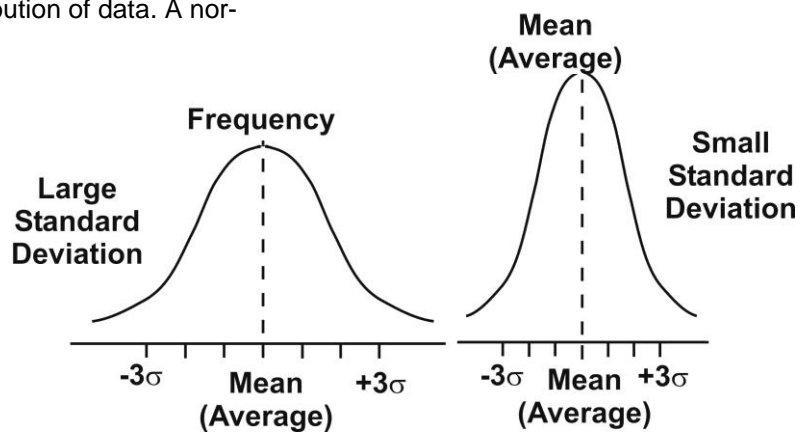
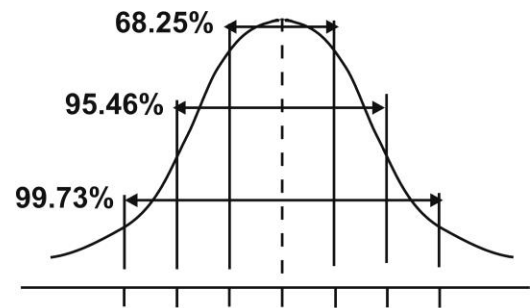

1.7 Laser Safety

1.7.1 Output Beam Data

1.7.1.1 BenchMike Pro

Radiant Power: 1 milliwatt

Wavelength: 635 nm (only)

1.7.2 Warning Information

The BenchMike Pro is equipped with a warning label as a reminder that a laser is present during operation.

If a problem occurs with the operation of the BenchMike Pro, contact NDC Technologies Customer Service immediately.

Only trained NDC Technologies service personnel should perform service operations on this product. The use of controls or adjustments or the performance of procedures other than those specified in this manual may result in hazardous radiation exposure.

See also the [safety](#) warnings at the beginning of this handbook.

2 | Installation

2.1 Instructions

2.1.1 Power

To power the BenchMike Pro, use the supplied, detachable mains supply cord. Using an under-rated or not-certified power cord is a safety hazard. Only power cords with the appropriate ratings for the country of use and with a rating of 5 amps or greater should be used. When the BenchMike Pro is powered off, it is in standby mode. To completely turn off the BenchMike Pro, disconnect the power cord from the back of the unit.

2.1.2 Lifting

The BenchMike Pro should be lifted by a mechanical lift, using either a forklift or straps under each end of the unit. See the outline drawings later in this section.

2.1.3 Location

The BenchMike Pro can be placed on a sturdy horizontal surface with no attachments. The BenchMike Pro receives AC power through the supplied power cord connected to the rear panel inlet, and it is turned on or off by the switch on the rear of the unit. No special grounding connections are required except through the standard power cord provided. Never bypass the safety ground on a power cord. If this equipment is not installed and used according to the installation procedures, the safety of this unit could be compromised.

2.1.4 Ventilation Requirements

The BenchMike Pro has no venting or cooling fan. There are no special cooling requirements other than maintaining the unit within the correct operating temperature range.

2.1.5 Equipment Maintenance

The touchscreen can be cleaned with a mild window cleaner. The laser aperture windows can be cleaned with a mild window cleaner or isopropyl alcohol and cotton swabs. It is recommended that an oscilloscope be connected to the Scan Out jack on the end of the BenchMike Pro when cleaning the aperture windows. The rest of the unit can be cleaned with a mild spray cleaner.

2.1.6 Caution Symbol

This product should only be used or serviced by trained NDC Technologies personnel. Failure to do so could result in physical injury, damage to the product, and/or voiding of the warranty. If you have any questions or problems, please contact the NDC Technologies Customer Service Department.



2.2 Drawings

Use the following drawings to install the BenchMike Pro.

2.2.1 BenchMike Pro Model 2025 Outline Drawing

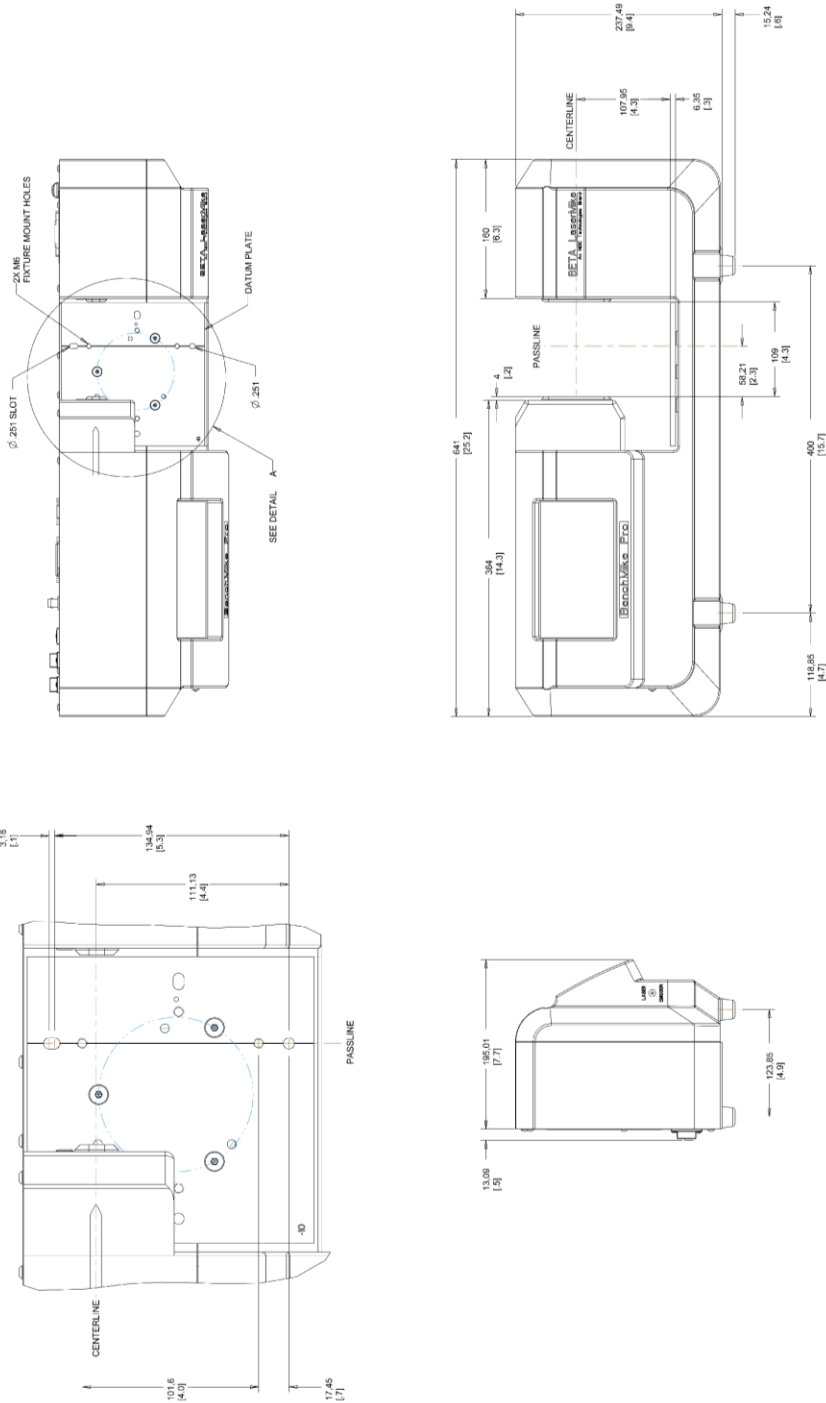

NOTE: Dimensions are in millimeters (inches).

NOTE: mount the universal mounting plate with the -10 in the lower left corner (as seen looking downward from the operator's position) of the BenchMike Pro's measurement area.

2.2.2 BenchMike Pro Model 2025 Connector Drawing

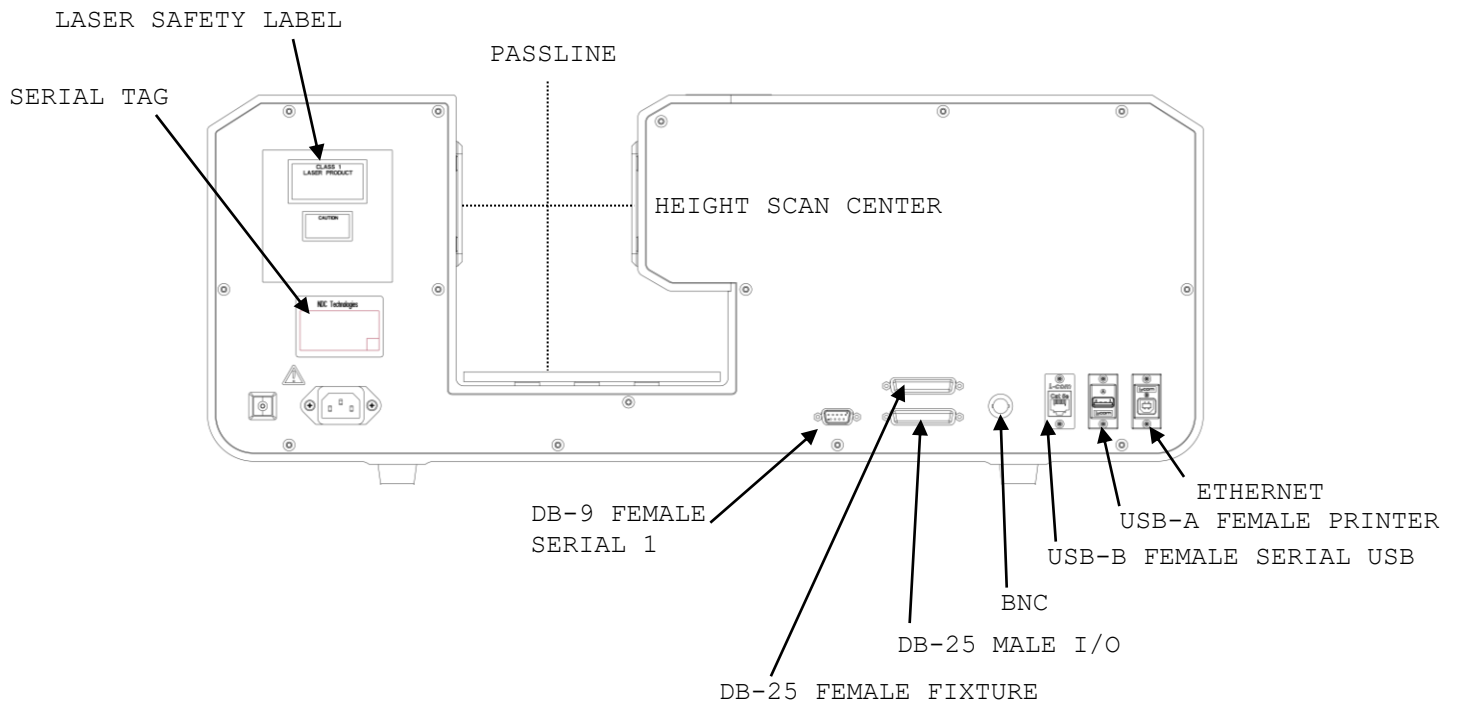

2.2.3 BenchMike Pro Model 2050 Outline Drawing

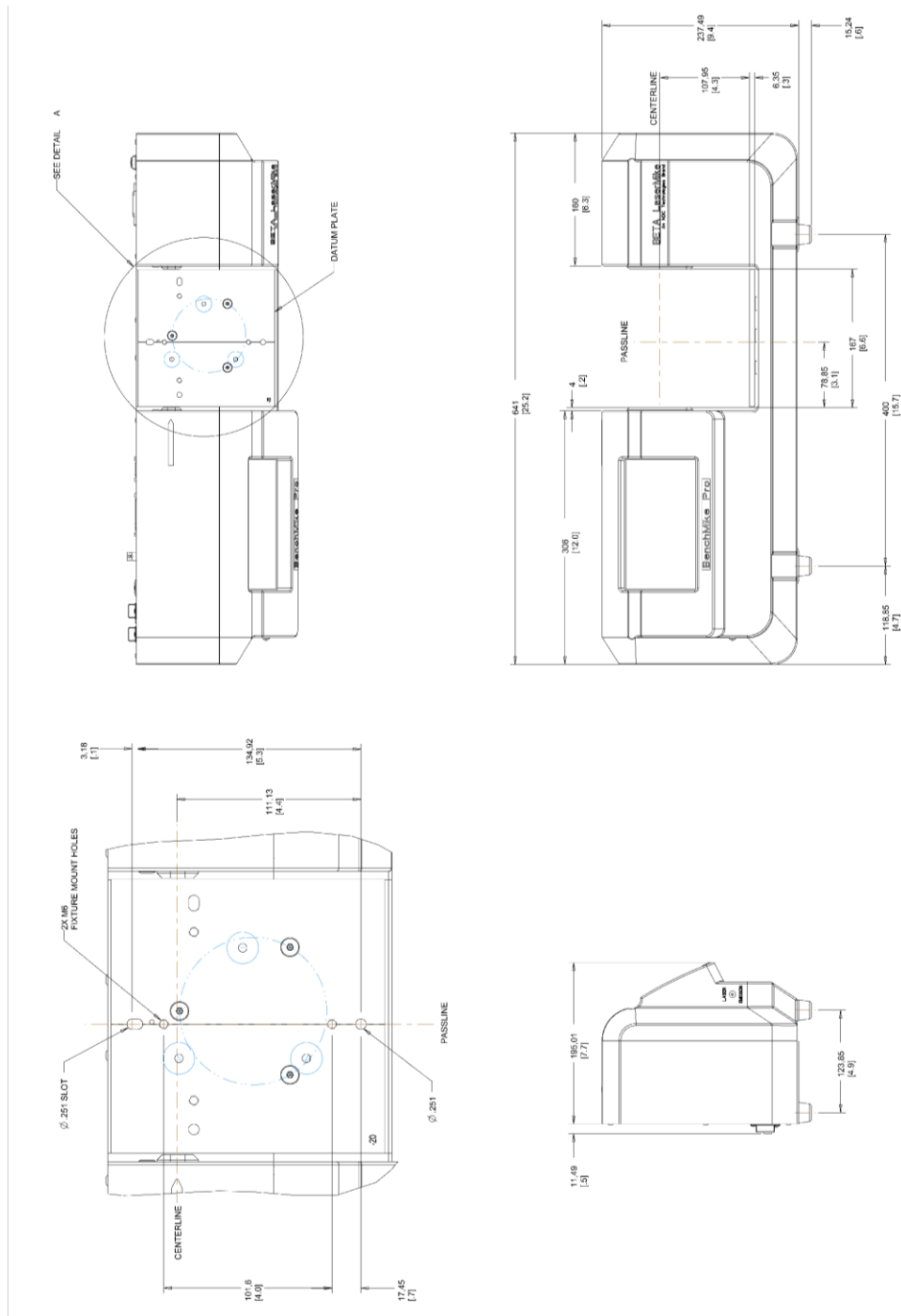

NOTE: Dimensions are in millimeters (inches).

NOTE: Mount the universal mounting plate with the -20 in the lower left corner (as seen looking downward from the operator's position) of the BenchMike Pro's measurement area.

2.2.4 BenchMike Pro Model 2050 Connector Drawing

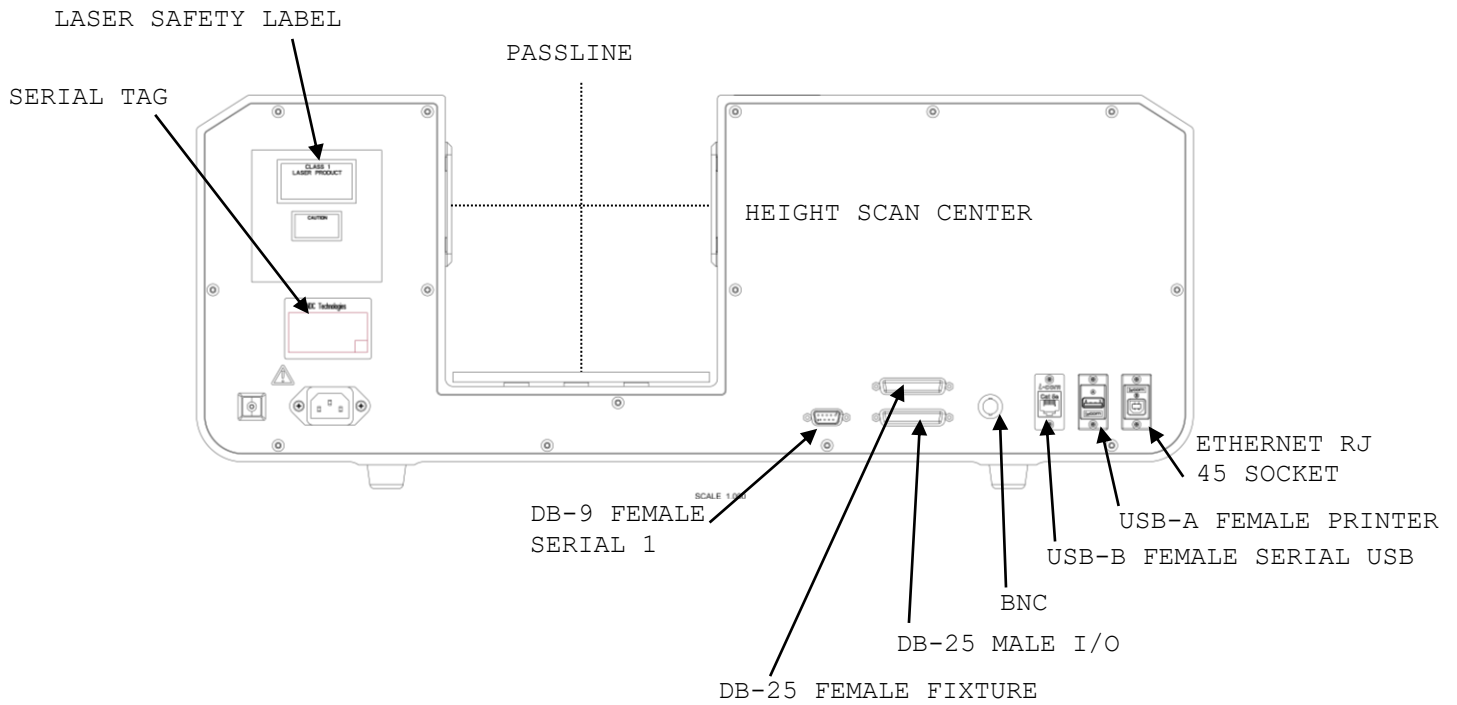

2.3 Connections

2.3.1 Connecting the BenchMike Pro to Your PC

Use the BenchMike Pro's serial port, labeled Serial #1, to connect your PC to the BenchMike Pro. The cable used to connect the BenchMike Pro and PC should be a shielded, straight-through cable with a DB-9 female connector on one end and a DB-9 male connector on the other end. A straight-through cable can be purchased from most electronic and computer stores. The drawing below shows the wiring for a straight-through cable.

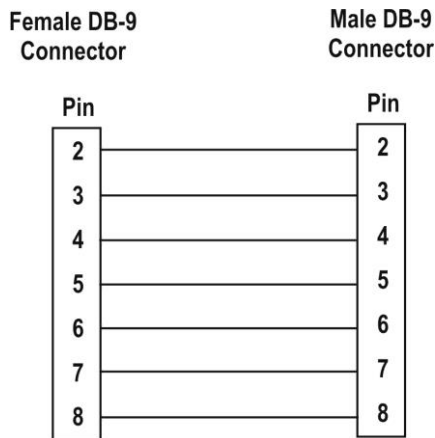

2.3.2 Digital I/O Connector

The digital I/O connector is a DB-25 connector. The number of inputs and outputs on a BenchMike Pro will vary based on the number ordered by the customer.

There is a maximum of 8 software-readable inputs, supports level or transition detection, and each input is pulled up to 5 V with a 4.7K resistor.

Alarm outputs are open-collector, with a maximum voltage of 35 V DC. The output current is 250 mA per output. Individual outputs have selectable NO or Normally Open states.

The following table shows the pin definitions of this connector.

Pin Number	Function
1	+12 Volts
2	Digital input, #1
3	Digital input, #2
4	Digital input, #3
5	Digital input, #4
6	+12 Volts

7	Alarm #4 (-Reject)
8	Alarm #3 (-Warning)
9	Alarm #2 (+Warning)
10	Alarm #1 (+Reject)
11	+5 Volts
12	Signal ground
13	Signal ground
14	N. C.
15	N.C.
16	Alarm 11*
17	Alarm 12*
18	Alarm 10
19	Alarm 9
20	Signal ground
21	Alarm 8
22	Alarm 7
23	Alarm 6
24	Alarm 5
25	+12 Volts

* Non-sequential order is intentional.

2.3.3 Connecting to Digital Inputs

Consult the diagram below to connect digital inputs to your BenchMike Pro.

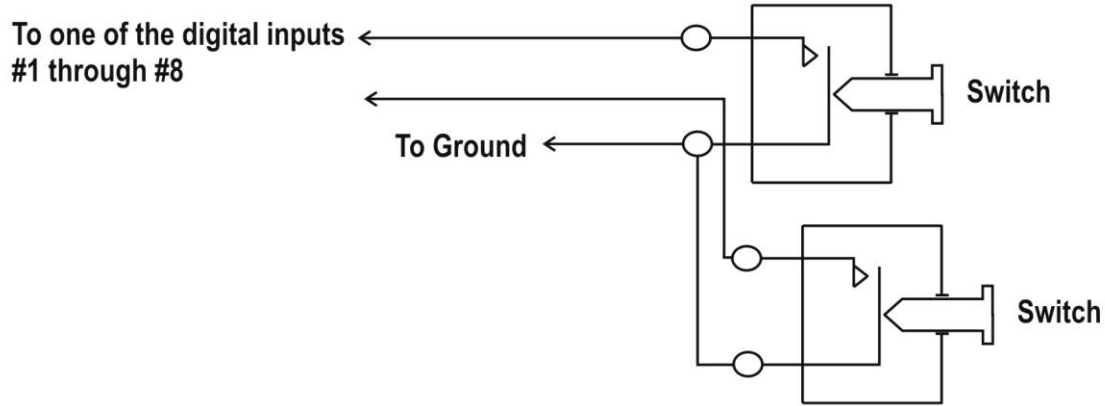

See the description of system functions for software configuration of digital inputs for details.

2.3.4 Connecting to Digital Outputs with the BenchMike Pro +12V Supply

Consult the diagram below to connect digital outputs via the BenchMike Pro's +12 V supply.

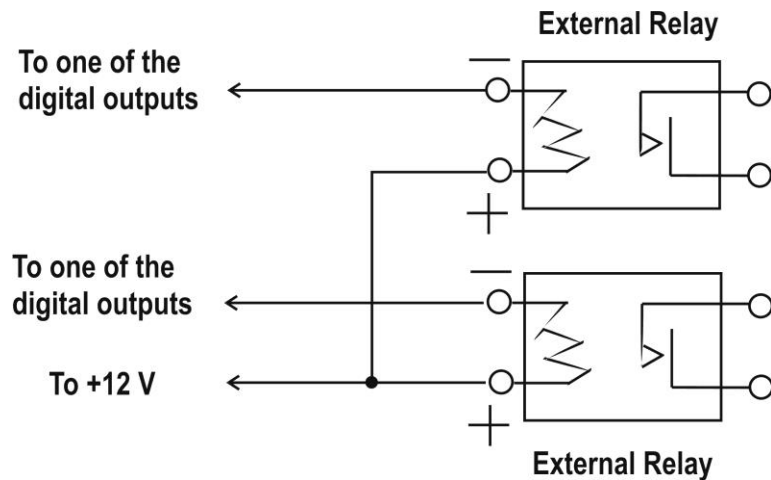

See the description of the system functions for software configuration of digital outputs for details.

2.3.5 Connecting to Digital Outputs with an External Supply

Consult the diagram below to connect digital outputs via an external supply.

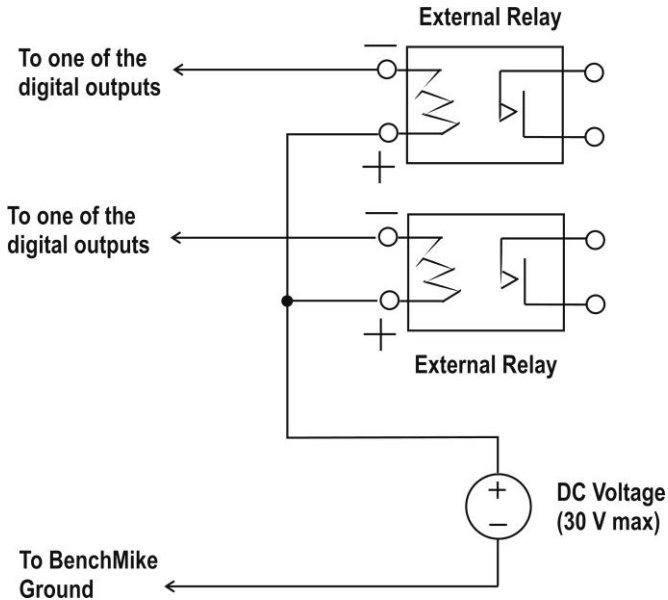

See the description of the system functions for software configuration of digital outputs for details.

2.3.6 Serial Connector

The BenchMike Pro has one standard serial port. This port supports RS232 interfaces and baud rates up to 38.4 Kbaud. Handshaking protocol options are RTS/CTS and none. Data items available for transmission are from the Data menus. Data format options such as Labels, Headers, Delimiters, and Terminators as well as data flow options are available for selection from the Settings-Serial Data Out Format menus. DB-9 connectors are used for these ports.

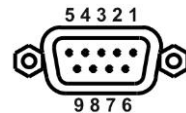

2.3.6.1 Serial Connector (#1) Pin-out

Pin Number	Function	Direction
1	Frame ground	—
2	Send data	Output
3	Receive data	Input
5	Signal ground	—
6	Data set ready	Output
7	Request to send	Input
8	Clear to send	Output

2.3.7 USB Printer Connector

The USB A connector is for a CUPS-compatible printer.

2.3.8 USB Serial Connector

The USB B simulates a serial port when connected to a P.C.

2.3.9 Ethernet RJ45 Connector

The Ethernet connection uses a telnet connection to send and receive PURL commands and send data.

2.3.10 Fixture Connector

The fixture connector offers two four-bit output ports capable of driving a four-phase stepper motor. Port #1 (Pins 2 – 5) can be used for either a motor port OR open-collector outputs. Port #2 (Pins 7 – 10) can be used for either for a motor port OR open-collector outputs. Port #1 comes configured from the factory with a motor driver chip installed. Port #1 and #2 come configured from the factory with motor driver chips installed. Both ports can be used at the same time. The BenchMike Pro is designed to control both a rotating fixture and a linear fixture at the same time.

The pin-out for this DB-25 connector is shown below.

Pin Number	Function
1	+12 V
2	Port #1 phase A+ for driving a motor
3	Port #1 phase A- for driving a motor
4	Port #1 phase B+ for driving a motor
5	Port #1 phase B - for driving a motor
6	+12 V
7	Port #2 phase A+ for driving a motor
8	Port #2 phase A- for driving a motor
9	Port #2 phase B+ for driving a motor
10	Port #2 phase B- for driving a motor
11	+5 V
12	Signal ground
13	Signal ground

14	I ² C-SDA Serial data line
15	I ² C-SCK Clock
16	Digital input #5
17	Digital input #6
18	Digital input #7
19	Digital input #8
20	Signal ground
21	Quad encoder #1 input A
22	Quad encoder #1 input B
23	Quad encoder #2 input A
24	Quad encoder #2 input B
25	+12 V

2.3.11 Connecting to a Quadrature Encoder

Consult the diagram below to connect a quadrature encoder to your BenchMike Pro.

DO NOT CONNECT a negative voltage to any quadrature encoder input.

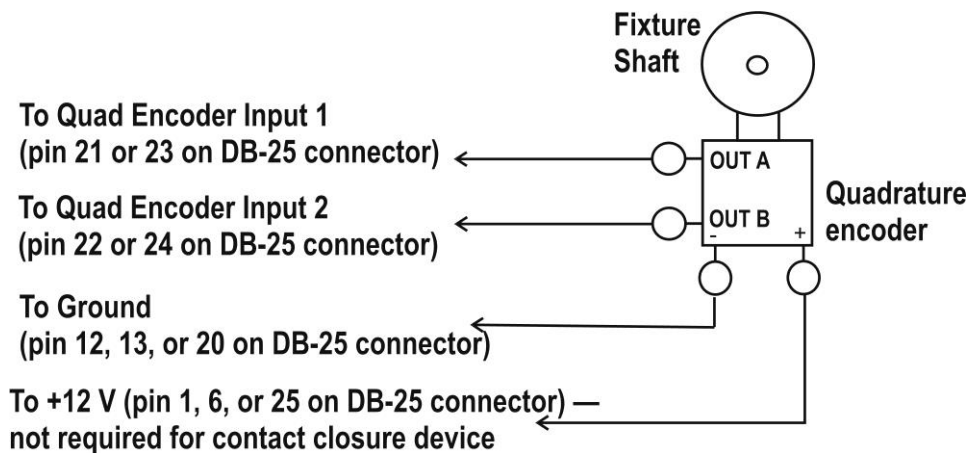

See the description of the system functions for software configuration of a fixture for details.

2.4 Adding a Network Printer

2.4.1 Requirements

The following requirements must be met to allow the BenchMike Pro to print to a network-attached printer:

- The BenchMike Pro must be able to access the printer via Ethernet.
- The operator must have a PC with a web browser attached to the same network as the BenchMike Pro.
- The target printer must be on the same network.

2.4.2 Procedure

1. Ensure an appropriate PC Network configuration, e.g., **10.32.0.60**

```
Ethernet adapter Local Area Connection:

Connection-specific DNS Suffix . : internal.ndcinfrared.com
Link-local IPv6 Address . . . . . : fe80::4aef:29a:65a1:41fd%11
IPv4 Address. . . . . : 10.32.0.60
Subnet Mask . . . . . : 255.255.240.0
Default Gateway . . . . . : 10.32.1.253
```

2. Verify the IP configuration of the printer, e.g., **10.32.2.15**

```
C:\>ping 10.32.2.15

Pinging 10.32.2.15 with 32 bytes of data:
Reply from 10.32.2.15: bytes=32 time<1ms TTL=255
Reply from 10.32.2.15: bytes=32 time<1ms TTL=255
Reply from 10.32.2.15: bytes=32 time<1ms TTL=255
Reply from 10.32.2.15: bytes=32 time<1ms TTL=255

Ping statistics for 10.32.2.15:
    Packets: Sent = 4, Received = 4, Lost = 0 (0% loss),
    Approximate round trip times in milli-seconds:
        Minimum = 0ms, Maximum = 0ms, Average = 0ms
```

3. Define the BenchMike Pro Ethernet Settings, e.g., 10.32.0.65 (again, the same network). Ensure that the Use DHCP box is checked. Restart the BenchMike Pro to ensure that the IP address is set correctly.

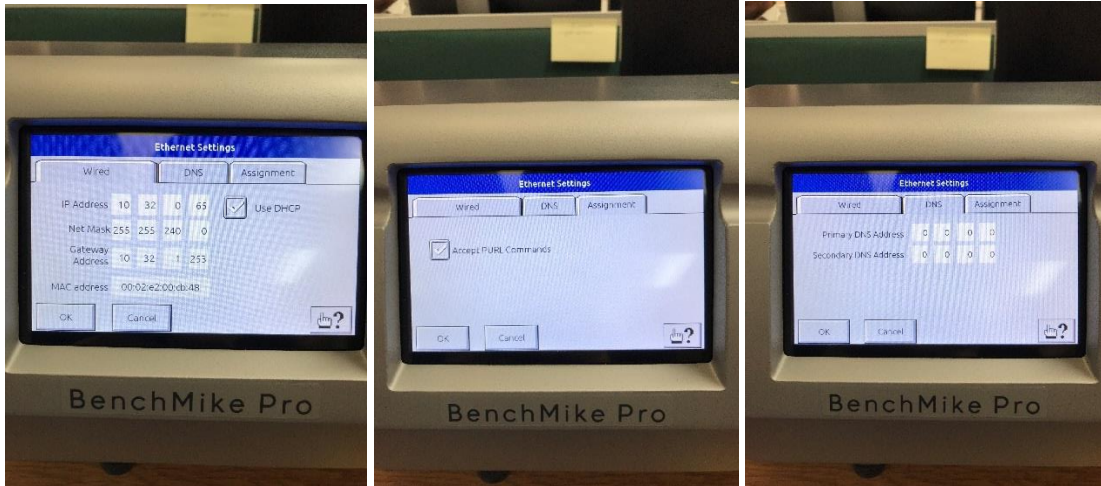

4. Connect via the web browser to address: <https://10.32.0.65:631/admin/> , where 10.32.0.65 is the BenchMike Pro IP address.
5. Two different security warnings may appear. You may see the screen below, and if so, select **Continue to this website**.





There is a problem with this website's security certificate.

The security certificate presented by this website was issued for a different website's address.
The security certificate presented by this website was not issued by a trusted certificate authority.

Security certificate problems may indicate an attempt to fool you or intercept any data you send to the server.

We recommend that you close this webpage and do not continue to this website.

 [Click here to close this webpage.](#)

 [Continue to this website \(not recommended\).](#)

 [More information](#)

Alternately, you may encounter a different network warning when attempting to add the printer. This warning may be bypassed by clicking on the **Advanced** button.

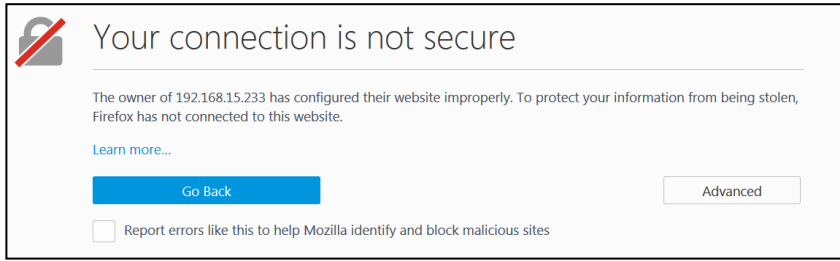

then clicking the Add Exception button.

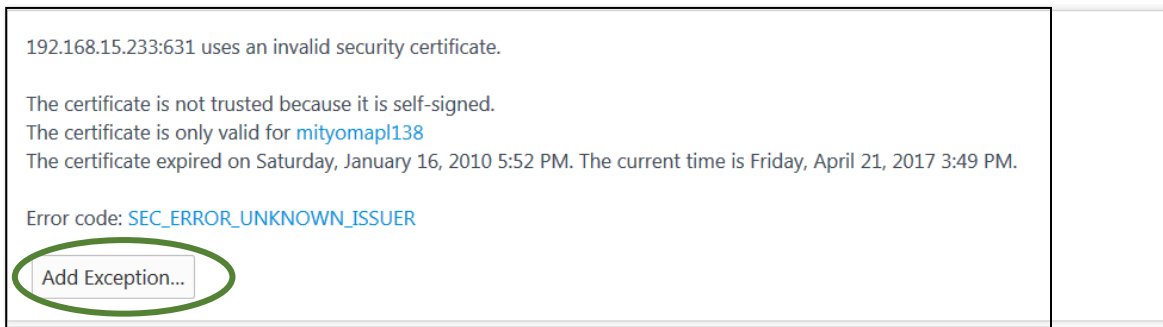

Finally, click the Confirm Security Exception button.

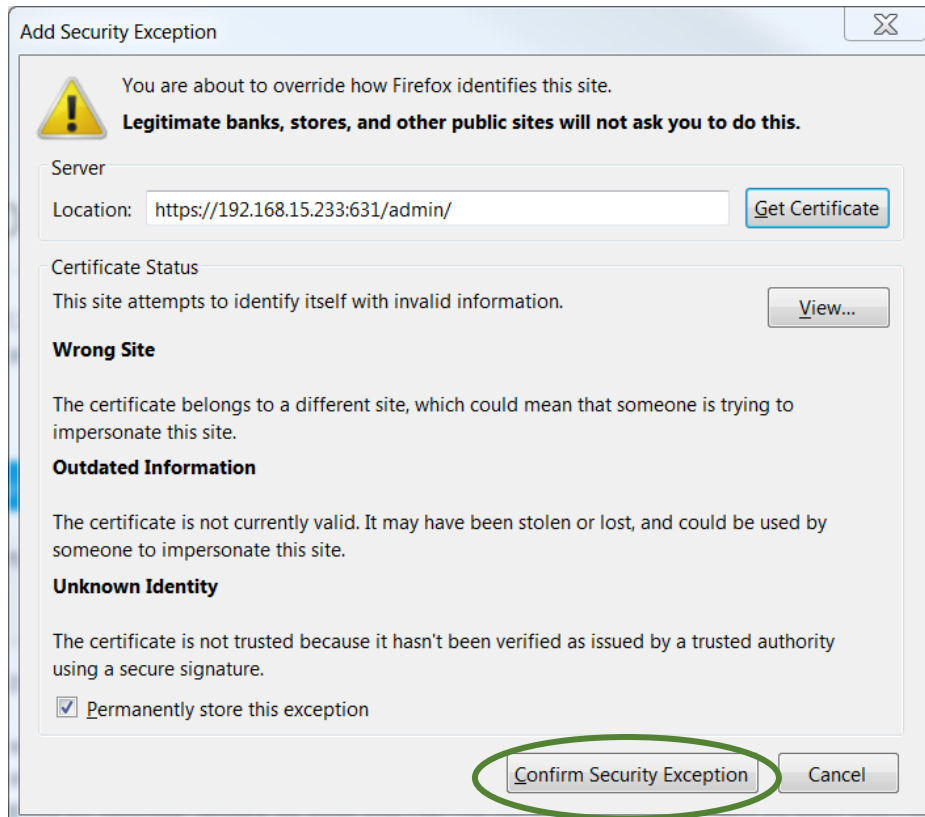

6. The printer CUPS server will appear as shown.

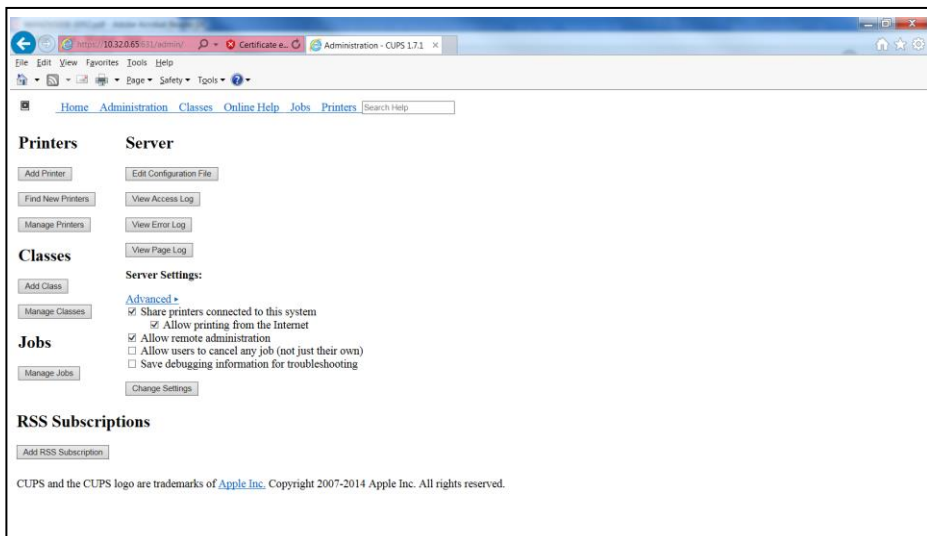

7. Select **Add Printer**



8. There are two options for you to select the desired printer.
If your printer appears in the Discovered Network Printers list, select the appropriate printer. If not, but if you know the IP address, select the Internet Printing Protocol (ipp) option. In either case, then select Continue to proceed.

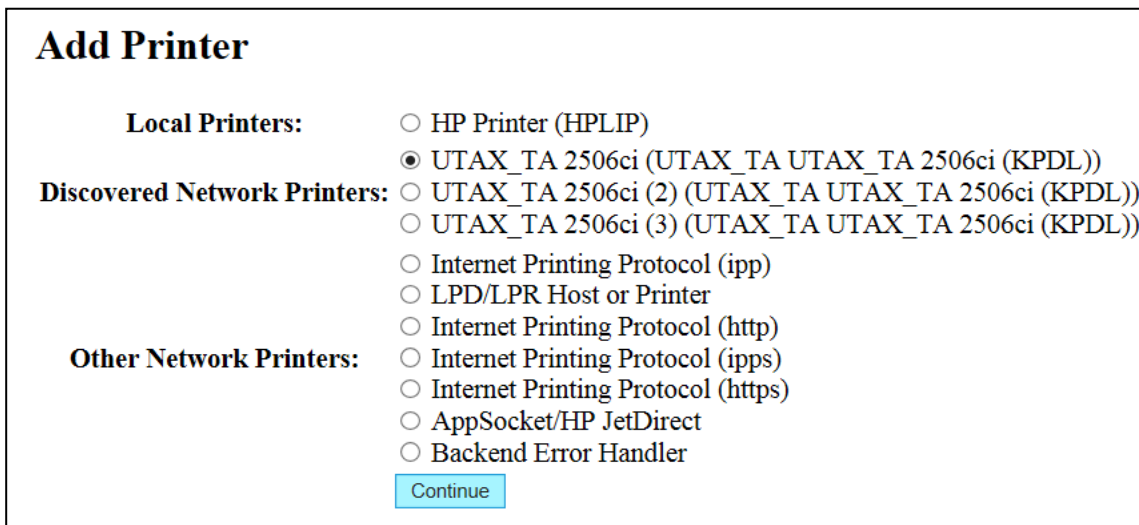

9. If you selected Internet Printing Protocol (ipp), a screen will appear to allow you to enter the IP address of your printer. Enter the address in the format shown in the image below, then click Continue. If your printer was in the list of Discovered Network Printers, skip to the next step.

Add Printer

Connection:

Examples:

```
http://hostname:631/ipp/  
http://hostname:631/ipp/port1  
  
ipp://hostname/ipp/  
ipp://hostname/ipp/port1  
  
lpd://hostname/queue  
  
socket://hostname  
socket://hostname:9100
```

See "[Network Printers](#)" for the correct URI to use with your printer.

10. Add text to define your **Location**, then select Continue.

Add Printer

Name:
(May contain any printable characters except "/", "#", and space)

Description:
(Human-readable description such as "HP LaserJet with Duplexer")

Location:
(Human-readable location such as "Lab 1")

Connection: dnssd://UTAX_TA%202506ci%20(2)._ipp._tcp.local/

Sharing: Share This Printer

11. Select a Make of **Raw**, then select Add printer.

Add Printer

Name: UTAX_TA_UTAX_TA_2506ci_
Description: UTAX_TA UTAX_TA 2506ci (KPDLL)
Location: Office
Connection: dnssd://UTAX_TA%202506ci._ipps._tcp.local/
Sharing: Do Not Share This Printer

Make:

- Apollo
- Dymo
- Epson
- Generic
- HP
- Intellitech
- Oki
- Raw**
- Zebra

Or Provide a PPD File:

12. Select **Raw Queue (en)** and then Add Printer.

Add Printer

Name: UTAX_TA_UTAX_TA_2506ci_
Description: UTAX_TA UTAX_TA 2506ci (KPDL)
Location: Office
Connection: dnssd://UTAX_TA%202506ci%20(2)._ipp._tcp.local/
Sharing: Do Not Share This Printer
Make: Raw
Model:
Or Provide a PPD File:

CUPS and the CUPS logo are trademarks of [Apple Inc.](#) Copyright 2007-2014 Apple Inc. All rights reserved.

13. Select “retry-job” for the Error Policy. Then click the “Set Default Options” button at the bottom of the page.

Set Default Options for UTAX_TA_UTAX_TA_2506ci_

[Banners](#) [Policies](#)

Banners

Starting Banner:
Ending Banner:

Policies

Error Policy:
Operation Policy:

CUPS and the CUPS logo are trademarks of [Apple Inc.](#) Copyright 2007-2014 Apple Inc. All rights reserved.

14. Select the desired printer.

Set Default Options for UTAX_TA_UTAX_TA_2506ci_

Printer UTAX_TA_UTAX_TA_2506ci default options have been set successfully.

CUPS and the CUPS logo are trademarks of [Apple Inc.](#) Copyright 2007-2014 Apple Inc. All rights reserved.

15. Select Administration option and on pull down menu, select Set As Server Default

UTAX TA UTAX TA 2506ci (Idle, Accepting Jobs, Not Shared, Server Default)

Maintenance ▾

- Administration ←
- Modify Printer
- Delete Printer
- Set Default Options
- Set As Server Default
- Set Allowed Users

UTAX TA UTAX TA 2506ci (KPD)

Driver: Local Raw Printer (grayscale)

Connection: dnssd://UTAX_TA%202506ci%20(2)._ipp._tcp.local/

Defaults: job-sheets=none, none media=unknown

Jobs

Search in UTAX_TA_UTAX_TA_2506ci :

16. A confirmation message will appear as shown.

Set Printer UTAX_TA_UTAX_TA_2506ci As Default

Printer UTAX_TA_UTAX_TA_2506ci has been made the default printer on the server.

Note: Any user default that has been set via the `lptions` command will override this default setting.

CUPS and the CUPS logo are trademarks of [Apple Inc.](#) Copyright 2007-2014 Apple Inc. All rights reserved.

17. From the BenchMike Pro, select Save and then cycle power to the unit.

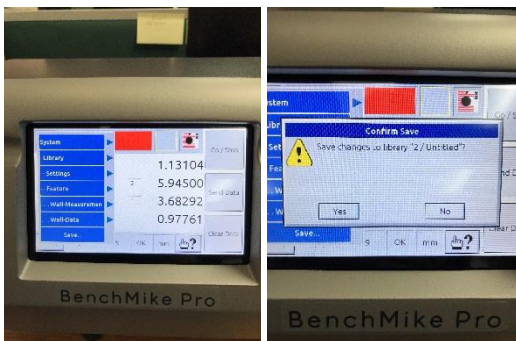

18. After the BenchMike Pro has rebooted, verify that the printer output has been set correctly. If not, repeat this procedure.

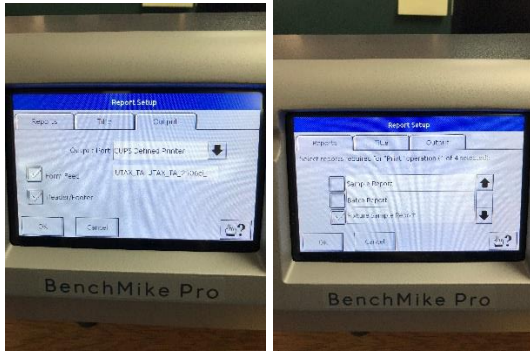

19. Go to Report Setup, and then the Output tab. Also select the type of report to output and test.

20. Verify the report.

```
ID
 3.20613   3.20649   3.20737   3.20776   3.20777   3.20789   3.20815
 3.20837

MAX: 3.20837  MIN: 3.20613  DIFF: 0.00224  AVG: 3.20749  SD: 0.000791
READINGS: 8

OD
 3.20850   3.20851   3.20901   3.20896   3.20818   3.20778   3.20785
 3.20789

MAX: 3.20901  MIN: 3.20778  DIFF: 0.00123  AVG: 3.20833  SD: 0.000488
READINGS: 8

Wall
 0.00118   0.00101   0.00082   0.00060   0.00021  -0.00006  -0.00015
-0.00024

MAX: 0.00118  MIN: -0.00024  DIFF: 0.00142  AVG: 0.00042  SD: 0.000555
READINGS: 8
```

2.5 Adding a USB Printer

2.5.1 Requirements

The following are required to allow the unit to print to a USB printer:

- A USB printer must be plugged into the USB A-type connector on the rear of the unit
- The operator must have a PC with a web browser attached to the same network as the unit.

2.5.2 Procedure

1. Ensure an appropriate PC Network configuration, e.g., **10.32.0.60**

```
Ethernet adapter Local Area Connection:

Connection-specific DNS Suffix . : internal.ndcinfrared.com
Link-local IPv6 Address . . . . . : fe80::42f3:29a:65a1:41fd%11
IPv4 Address. . . . . : 10.32.0.60
Subnet Mask . . . . . : 255.255.240.0
Default Gateway . . . . . : 10.32.1.253
```

2. Verify the IP configuration of the printer, e.g., **10.32.2.15**

```
C:\>ping 10.32.2.15

Pinging 10.32.2.15 with 32 bytes of data:
Reply from 10.32.2.15: bytes=32 time<1ms TTL=255
Reply from 10.32.2.15: bytes=32 time<1ms TTL=255
Reply from 10.32.2.15: bytes=32 time<1ms TTL=255
Reply from 10.32.2.15: bytes=32 time<1ms TTL=255

Ping statistics for 10.32.2.15:
    Packets: Sent = 4, Received = 4, Lost = 0 (0% loss),
    Approximate round trip times in milli-seconds:
        Minimum = 0ms, Maximum = 0ms, Average = 0ms
```

3. Define the BenchMike Pro Ethernet Settings, e.g., 10.32.0.65 (again, the same network). Ensure that the Use DHCP box is checked. Restart the BenchMike Pro to ensure that the IP address is set correctly.

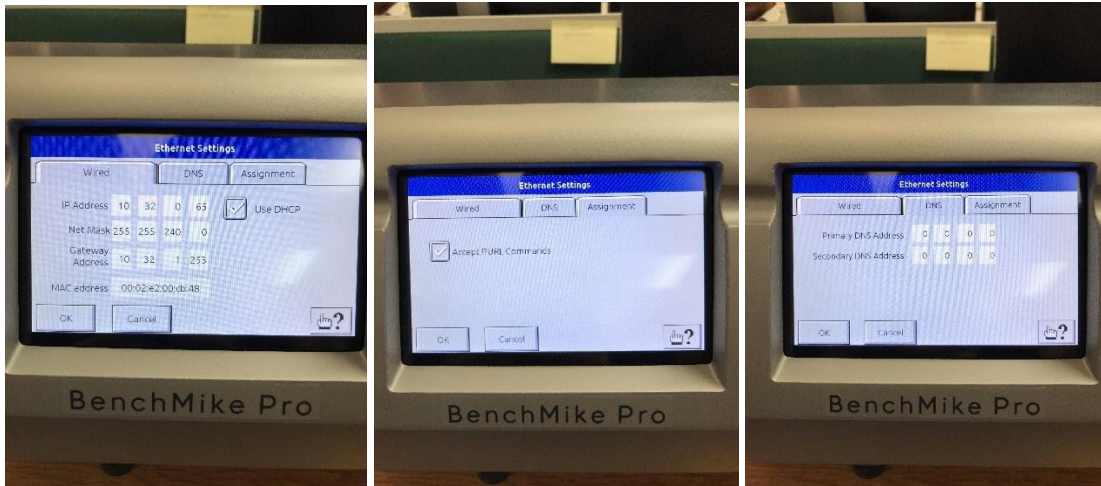

4. Connect via the web browser to address: <https://10.32.0.65:631/admin/> , where 10.32.0.65 is the BenchMike Pro IP address.
5. Two different security warnings may appear. You may see the screen below, and if so, select **Continue to this website**.

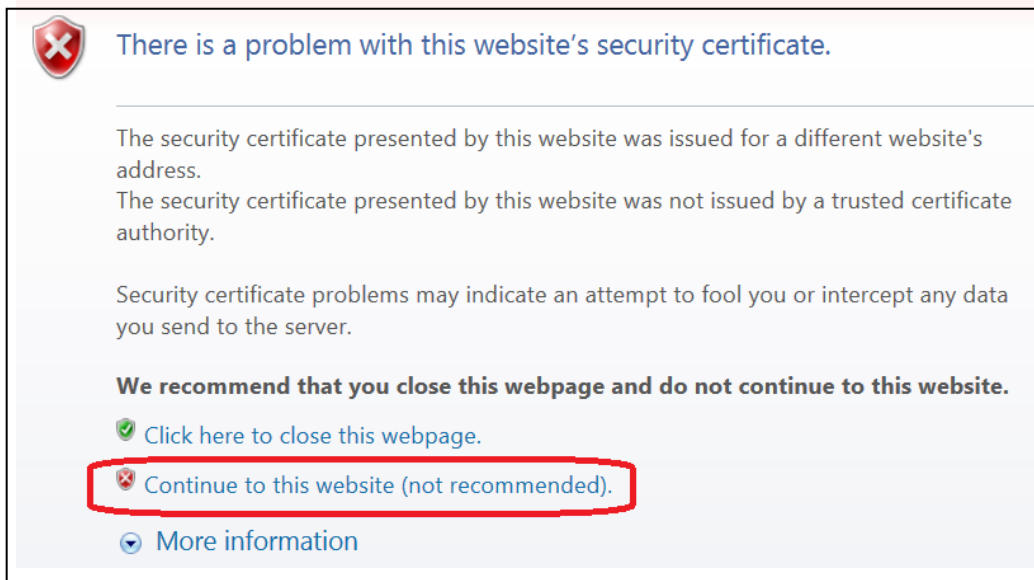

Alternately, you may encounter a different network warning when attempting to add the printer. This warning may be bypassed by clicking on the **Advanced** button.

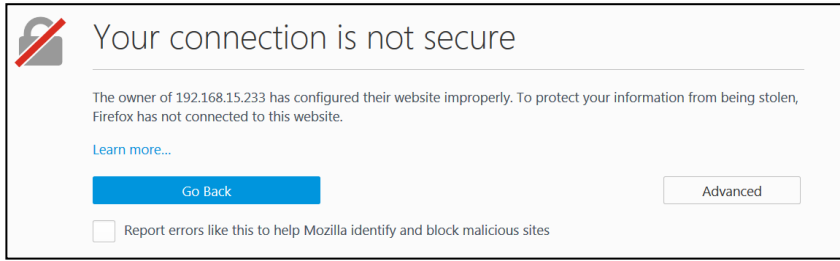

then clicking the Add Exception button.

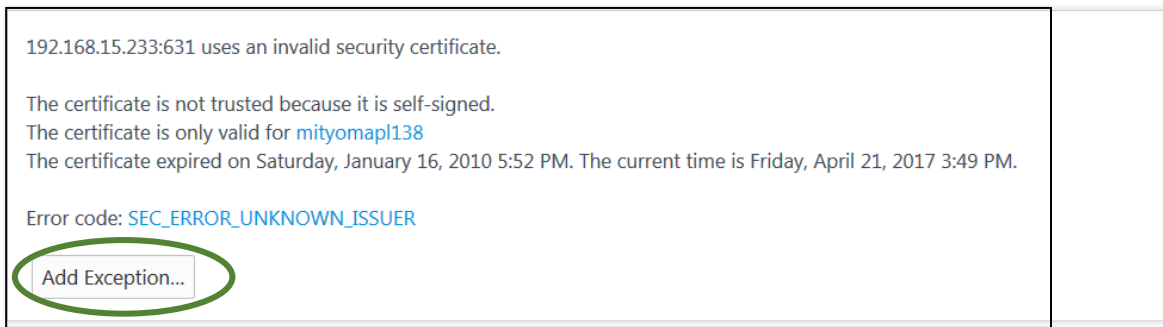

Finally, click the Confirm Security Exception button.

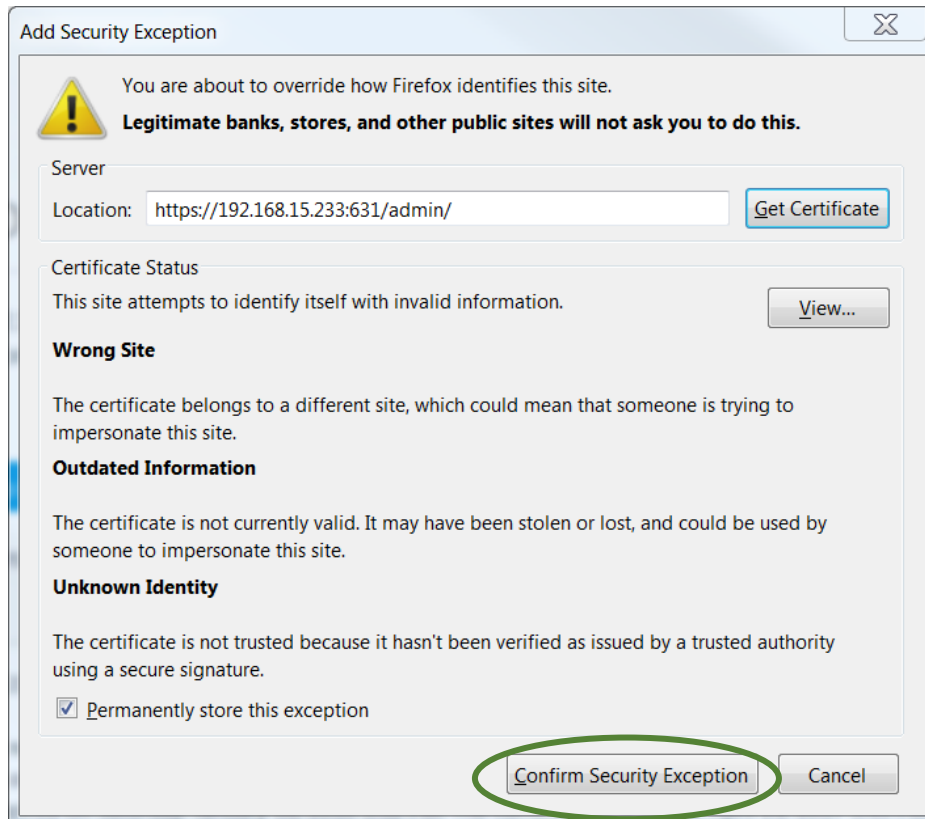

6. The printer CUPS server will appear as shown.

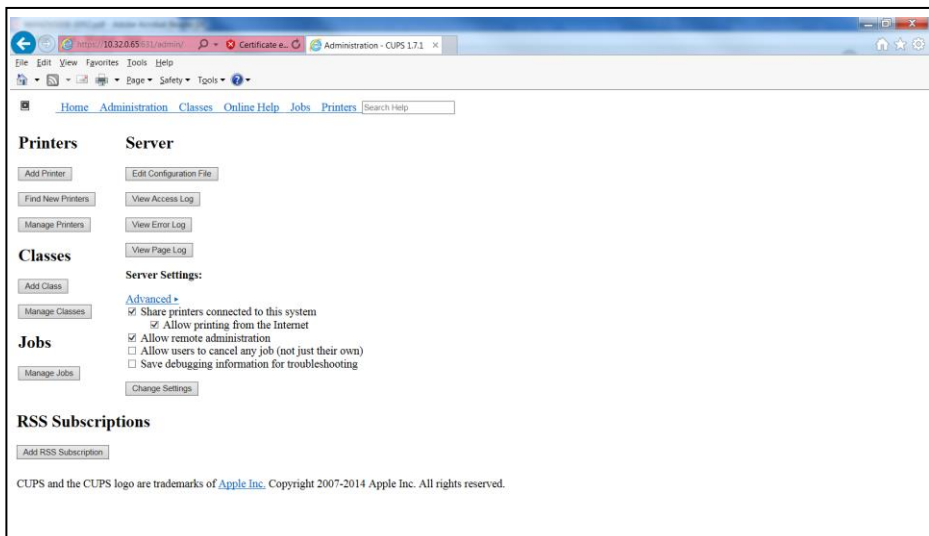

7. Select the Local Printer that is connected to the USB port. In this example, we use an HP LaserJet 1012 printer. Then press Continue.

Add Printer

Local Printers:

- HP LaserJet 1012 USB 00CNFB105800 HPLIP (HP LaserJet 1012)
- HP LaserJet 1012 (HP LaserJet 1012)

Discovered Network Printers:

- Internet Printing Protocol (ipp)
- LPD/LPR Host or Printer
- Internet Printing Protocol (http)

Other Network Printers:

- Internet Printing Protocol (ipps)
- Internet Printing Protocol (https)
- AppSocket/HP JetDirect
- Backend Error Handler

8. Enter identifying information for the printer as in the example, below, then click Continue.

Add Printer

Name: HP_LaserJet_1012
(May contain any printable characters except "/", "#", and space)

Description: HP LaserJet 1012
(Human-readable description such as "HP LaserJet with Duplexer")

Location: Desktop
(Human-readable location such as "Lab 1")

Connection: usb://HP/LaserJet%201012?serial=00CNFB105800

Sharing: Share This Printer

9. Click the Select Another Make/Manufacturer button. The BenchMike sends printer data as a Raw printer, not for a specific manufacturer driver.

Add Printer

Name: HP_LaserJet_1012

Description: HP LaserJet 1012

Location: Desktop

Connection: usb://HP/LaserJet%201012?serial=00CNFB105800

Sharing: Do Not Share This Printer

Make: HP | Select Another Make/Manufacturer

Model:

- HP LaserJet 1012, hpijs, 3.12.6 (en, en)
- HP LaserJet 1012, hpcups 3.12.6 (en)
- HP 910 hpijs, 3.12.6 (en, en)
- HP 910, hpcups 3.12.6 (en)
- HP 915 hpijs, 3.12.6 (en, en)
- HP 915, hpcups 3.12.6 (en)
- HP 2000c hpijs, 3.12.6 (en, en)
- HP 2000c, hpcups 3.12.6 (en)
- HP 2500c hpijs, 3.12.6 (en, en)
- HP 2500c, hpcups 3.12.6 (en)

Or Provide a PPD File: No file chosen

10. Choose the Raw Make, then click Continue.

Add Printer

Name:	HP_LaserJet_1012
Description:	HP LaserJet 1012
Location:	Desktop
Connection:	usb://HP/LaserJet%201012?serial=00CNFB105800
Sharing:	Do Not Share This Printer
Make:	<div data-bbox="516 529 678 877"><ul style="list-style-type: none">ApolloDymoEpsonGenericHPIntellitechOkjRawZebra</div>
	<div data-bbox="516 877 678 936"><input type="button" value="Continue"/></div>

11. Choose the Raw Queue (en) Model, then click Add Printer.

Add Printer

Name: HP_LaserJet_1012
Description: HP LaserJet 1012
Location: Desktop
Connection: usb://HP/LaserJet%201012?serial=00CNFB105800
Sharing: Do Not Share This Printer
Make: Raw

Model:

Or Provide a PPD File: No file chosen

12. Select “retry-job” for the Error Policy. Then click the “Set Default Options” button at the bottom of the page.

The screenshot shows a web browser window with the URL <https://10.243.18.137:631/admin>. The navigation menu includes Home, Administration, Classes, Online Help, Jobs, and Printers. The main heading is "Set Default Options for Hewlett-Packard_HP_LaserJet_P1505n". Below this, there are two sections: "Banners" and "Policies". In the "Banners" section, "Starting Banner" and "Ending Banner" are both set to "none", and a "Set Default Options" button is present. In the "Policies" section, "Error Policy" is set to "retry-job" and "Operation Policy" is set to "default". Both the "retry-job" dropdown and the "Set Default Options" button in this section are circled in green.

CUPS and the CUPS logo are trademarks of [Apple Inc.](#) Copyright 2007-2014 Apple Inc. All rights reserved.

13. Set the printer as the default by clicking the Set As Server Default option from the Administration dropdown list.

HP LaserJet 1012 (Idle, Accepting Jobs, Not Shared)

The screenshot shows the "Administration" dropdown menu open, with "Set As Server Default" highlighted in blue. Other options include Administration, Modify Printer, Delete Printer, Set Default Options, and Set Allowed Users. Below the menu, there is a "Jobs" section with a search bar for "HP_LaserJet_1012" and buttons for "Search" and "Clear". There are also buttons for "Show Completed Jobs" and "Show All Jobs". The text "No jobs." is displayed below the buttons.

3 | Workholding Fixtures

3.1 Error Signals

The BenchMike Pro is designed to detect system errors that occur as the result of improper part positioning, faulty keystrokes by the user, or component failure. When an error condition is detected, the BenchMike Pro alerts the operator by displaying an **ERR** message on the touch screen display.

3.2 Intelligent and Non-Intelligent Fixtures

Your BenchMike Pro may have been shipped with fixtures and integrated motion. Simple fixturing can be accommodated by the BenchMike Pro. These simple fixtures include both Intelligent and non-Intelligent Fixtures.

3.2.1 Non-Intelligent Fixture: Linear (Slide) Position

To access this page, select the Setup icon, then Data, and then Slide Position.

BenchMike Pros with the non-intelligent (legacy) fixture option can only display fixture position.

The Linear Position data item is available with non-Intelligent Fixtures, but cannot be used mathematically in the expression editor.

From the page shown, you can enable and disable serial output of the linear position data.

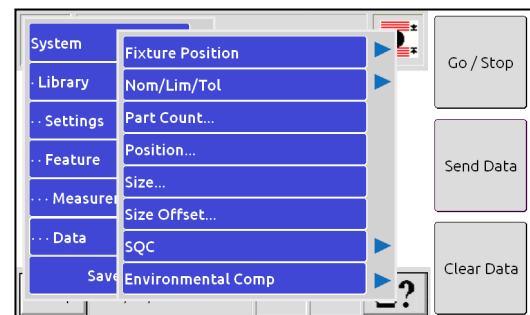

3.2.2 Intelligent Fixture: Rotary/Linear Fixture Position

To access this page, select the Setup icon, then Data, and then Fixture Position. Either Rotary Position or Linear Position will appear. Select the appropriate option.

The Intelligent Fixture allows the BenchMike Pro to operate with both rotary and linear fixtures, in both motorized and non-motorized configurations. Rotary fixtures include the ID/OD/Wall and Belt Drive fixtures.

Most NDC Technologies fixtures contain an ID chip. The Intelligent Fixture option allows the BenchMike Pro to read this ID chip to identify the name and physical characteristics of the fixture including motor, encoder, gear ratio, end of travel sensor, etc. If a fixture without an ID chip is being used, the BenchMike Pro must be set up manually to recognize the fixture. See the [Setup](#) section.

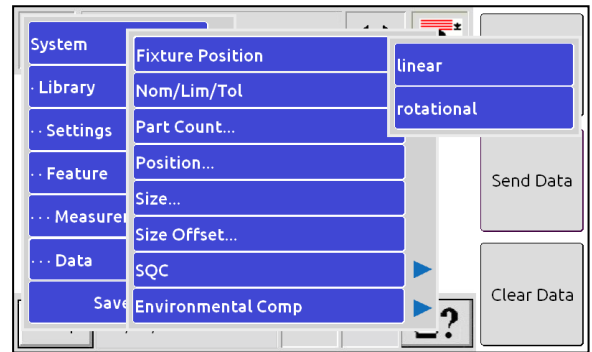

The Rotary Position or Linear Position data item can be defined mathematically when an Intelligent Fixture is in use. From Expression Editor, use the appropriate variable name in your expression: linpos1 or rotpos1.

3.3 Description of Fixtures

The following additional fixtures can be used with the BenchMike Pro.

NOTE: If you have a manual fixture, the BenchMike Pro will ask you when to start and stop measurements at each position. Motorized fixtures communicate this information directly to the BenchMike Pro.

3.3.1 General Purpose Fixed V-Block Fixture

The Fixed (or Universal) V-Block is designed to hold a wide variety of product sizes and types in the measurement area of the BenchMike Pro.

- Measurement ranges:
BenchMike Pro Model 2025: 0.762-22.86 mm (0.030-0.900 in.)
BenchMike Pro Model 2050: 0.762-45.72 mm (0.030-1.800 in.)
(The V-Blocks are identical except for the thickness of the mounting spacers)
- Wrought steel V-block with 120° included angle
- V-block is hardened to Rockwell C 40-45
- Polycarbonate mounting spacers are used to reduce heat transfer and provide a measure of thermal isolation
- Working surfaces are ground flat and parallel to the bottom of the mounting base within 0.01 mm/per cm (0.001 in./per in.) or better

3.3.1.1 Drawing of Fixed V-Block

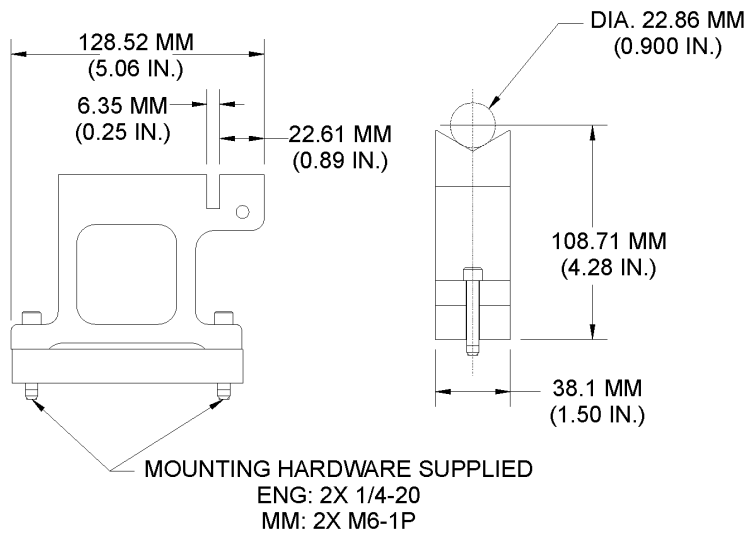

3.3.2 Universal Slide Fixture

The Universal Slide Fixture is used to linearly position parts by hand. Features include:

- Hardened dovetail rail mates with other fixtures, such as the Adjustable Centers and Adjustable V-Blocks
- Manual locking knob to lock the slide at a desired position
- Precision locating dowels ensure accurate mounting
- See Adjustable Centers and Adjustable V-Block description for information about maximum weight capacity
- Available in 3 lengths:
 - 1) Maximum travel is 300 mm (12 in.)
Overall slide length is 457.2 mm (18 in.)
 - 2) Maximum travel is 482.6 mm (19 in.)
Overall slide length is 635 mm (25 in.)
 - 3) Maximum travel is 660.4 mm (26 in.)
Overall slide length is 812.8 mm (32 in.)

3.3.2.1 Drawing of the Universal Slide

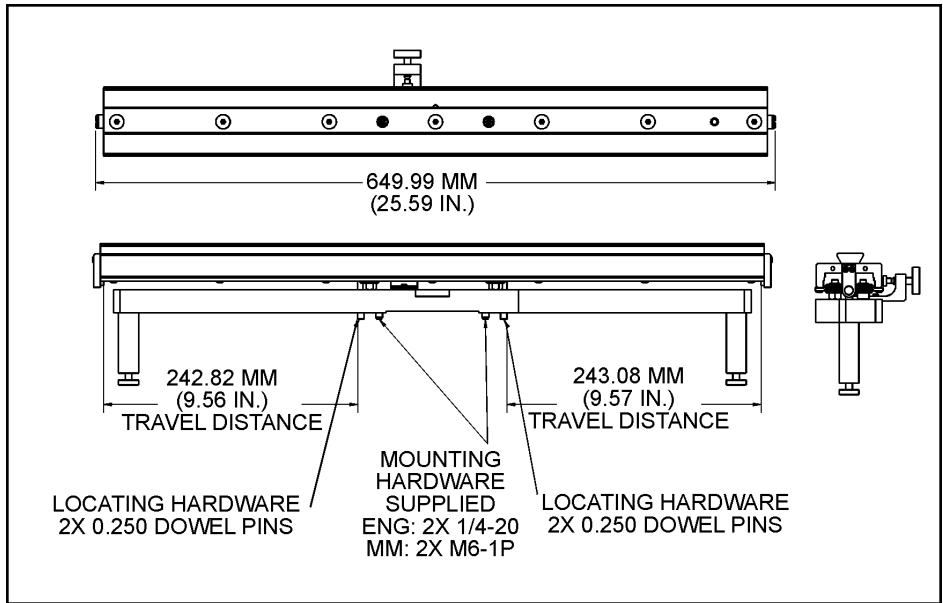

Features of **Adjustable Centers** include:

- Pair of adjustable male centers that mate with the dovetail rail. One center is lever-operated and spring-loaded for part loading.
- Hardened centers
- Centers diameter: 15.8 mm (0.625 in.)

Slide	A	B
18 in. Slide	282.45 mm (11.12 in.)	323.6 mm (12.74 in.)
25 in. Slide	460.25 mm (18.12 in.)	501.4 mm (19.74 in.)
32 in. Slide	638.05 mm (25.12 in.)	679.2 mm (26.74 in.)

- Adjustable Centers, mounted in the Universal Slide, will support a maximum weight equivalent to a 2-inch steel bar of length A (table above).

3.3.2.2 Drawing of the Adjustable Centers mounted on the Universal Slide

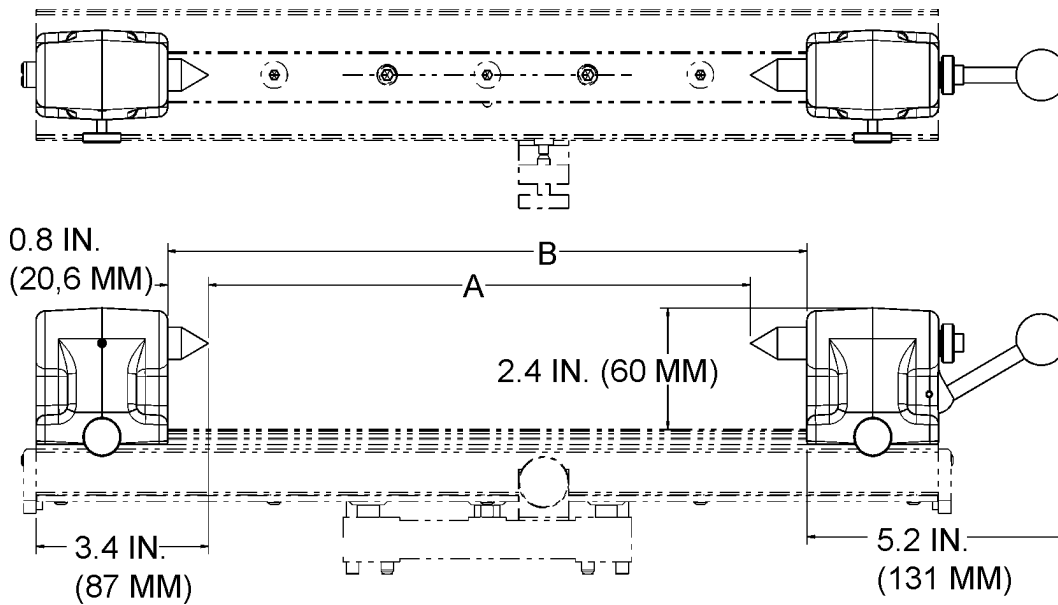

Features of **Adjustable V-Blocks** include:

- Pair of adjustable V-blocks that mate with the dovetail rail. V height is adjusted by locking knob. Millimeter position scale.
- V-block part size range: 2.286-50.8 mm (0.090-2.0 in.)
- V's are case-hardened with an included angle of 90°
- When mounted as shown, the maximum part length that will fit in the V-blocks without hanging over is as follows:

Slide	A
18 in. Slide	361.95 mm (14.25 in.)
25 in. Slide	539.75 mm (21.25 in.)
32 in. Slide	717.55 mm (28.25 in.)

- Adjustable V-Blocks, mounted in the Universal Slide, will support a maximum weight equivalent to a 2-inch steel bar of length A (table above).

3.3.2.3 Drawing of the Adjustable V-Blocks mounted on the Universal Slide

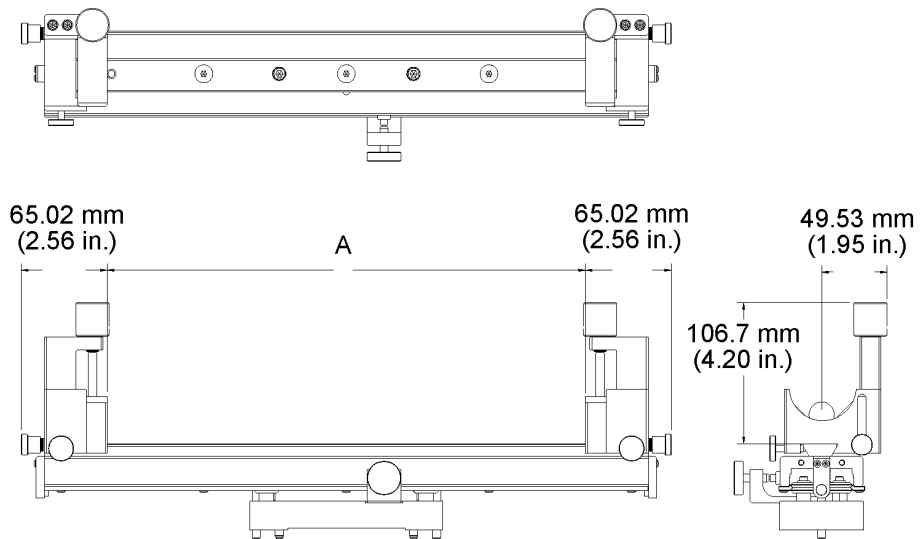

3.3.3 Digital Readout (DRO) Slide Fixture

The Digital Readout (DRO) Slide Fixture is used to linearly position parts to predetermined positions for measurement and/or to measure the distance between two points on a part. Features include:

- Direct readout of position on the BenchMike Pro screen
- Position display may be re-zeroed at any position with the Fixture Zero Position function of the BenchMike Pro
- Linear position encoder with 0.025 mm (0.0005 in.) resolution
- One-turn-per-inch lead screw with hand positioning knob
- Intelligent Fixture identification and setup via I2C bus interface
- Plugs into the Fixture Port on the BenchMike Pro
- Hardened dovetail rail mates with other fixtures
- Precision locating dowels ensure accurate mounting
- See Adjustable Centers and Adjustable V-Block description for information about maximum weight capacity
- Available in 3 lengths:
 - 1) Maximum travel is 300 mm (12 in.)
Overall slide length is 457.2 mm (18 in.)
 - 2) Maximum travel is 482.6 mm (19 in.)
Overall slide length is 635 mm (25 in.)
 - 3) Maximum travel is 660.4 mm (26 in.)
Overall slide length is 812.8 mm (32 in.)

3.3.3.1 Drawing of the DRO Slide

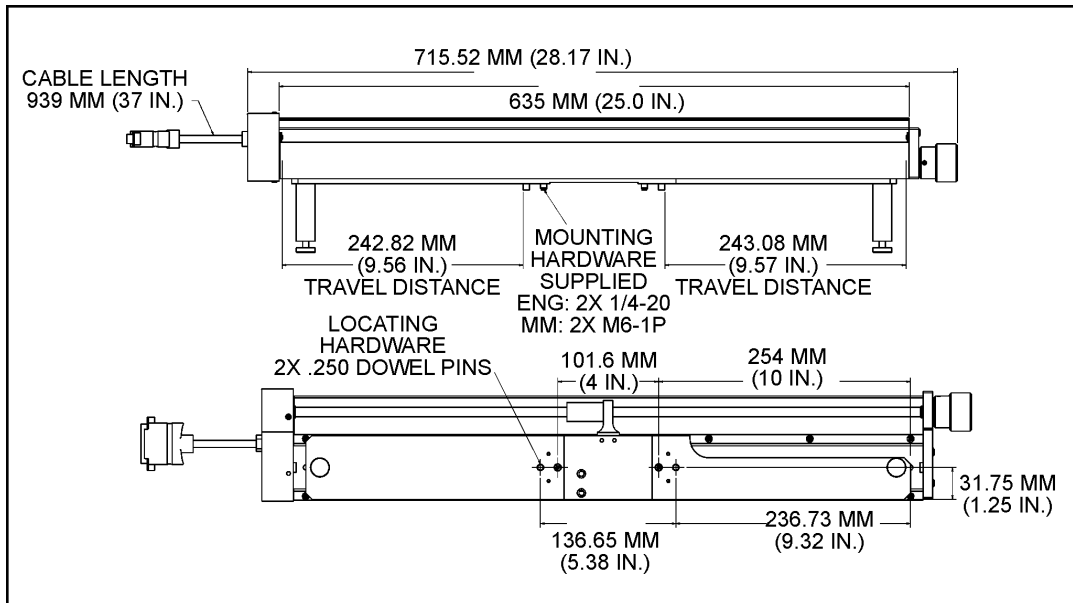

Features of **Adjustable Centers** include:

- Pair of adjustable male centers that mate with the dovetail rail. One center is lever-operated and spring-loaded for part loading.
- Hardened centers
- Centers diameter: 15.8 mm (0.625 in.)

Slide	A	B
18 in. Slide	282.45 mm (11.12 in.)	323.6 mm (12.74 in.)
25 in. Slide	460.25 mm (18.12 in.)	501.4 mm (19.74 in.)
32 in. Slide	638.05 mm (25.12 in.)	679.2 mm (26.74 in.)

- Adjustable Centers, mounted in the DRO Slide, will support a maximum weight equivalent to a 2-inch steel bar of length A (table above).

3.3.3.2 Drawing of the Adjustable Centers mounted on the DRO Slide

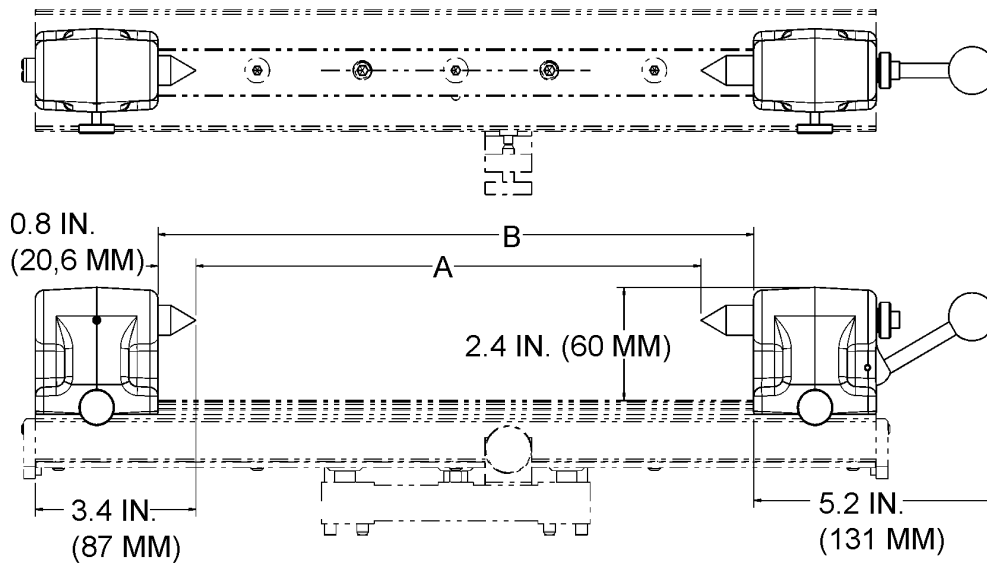

Features of **Adjustable V-Blocks** include:

- Pair of adjustable V-blocks that mate with the dovetail rail. V height is adjusted by locking knob. Millimeter position scale.
- V-block part size range: 2.286-50.8 mm (0.090-2.0 in.)
- V's are case-hardened with an included angle of 90°
- When mounted as shown, the maximum part length that will fit in the V-blocks without hanging over is as follows:

Slide	A
18 in. Slide	361.95 mm (14.25 in.)
25 in. Slide	539.75 mm (21.25 in.)
32 in. Slide	717.55 mm (28.25 in.)

- Adjustable V-Blocks, mounted in the DRO Slide, will support a maximum weight equivalent to a 2-inch steel bar of length A (table above).

3.3.3.3 Drawing of the Adjustable V-Blocks mounted on the DRO Slide

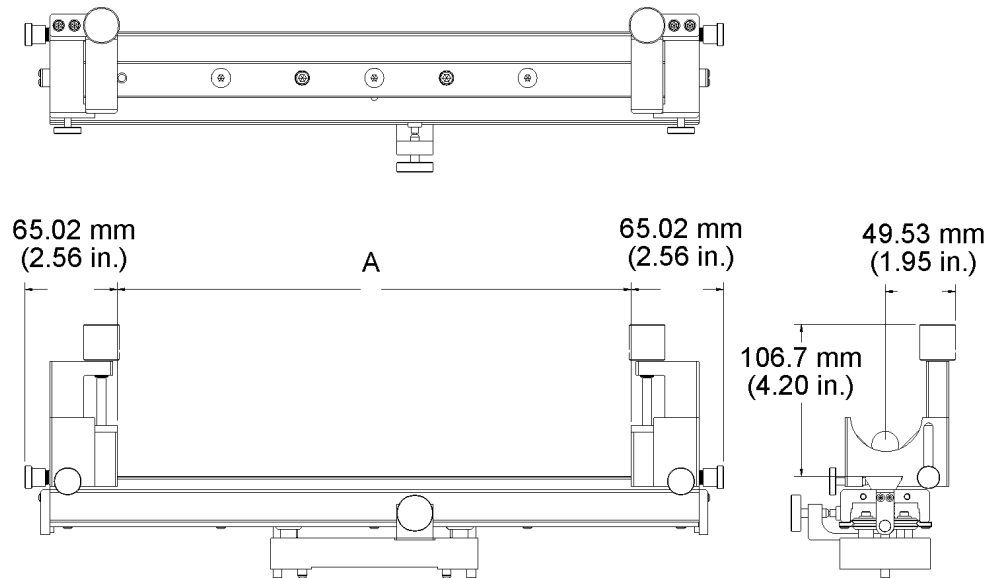

4 | Setup

Your instrument was carefully inspected electrically and mechanically prior to shipment. It should be free of surface marks and scratches, and it should be in perfect working order upon receipt. If any indication of damage is found, file a claim with the carrier immediately, prior to using the instrument. If no damage is apparent, proceed by using this manual to install and setup this instrument.

4.1 Setting Up the BenchMike Pro

4.1.1 Turning Power On

When the BenchMike Pro is turned on, the last saved display settings are shown and the last selected library is used. If the BenchMike Pro has been set to Lock, a password is required to perform setup operations. When shipped from the factory, the BenchMike Pro is not locked.

4.1.2 Using the Three Data Buttons

The three data buttons on the right of the touch screen are used to perform three common functions: **Go/Stop** to start or stop performing measurements, **Send Data** to send data via the serial port, and **Clear Data** to erase all accumulated data. These three buttons can be customized to perform different functions.

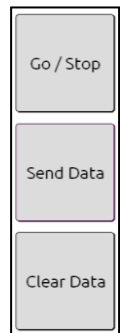

4.1.3 Touch Screen Layout

When the BenchMike Pro is turned on, the main measurement display will appear. In addition to displaying your measurements, this page provides access to menus used to configure the BenchMike Pro and displays general information, such as the presence or absence of error conditions.

The bar along the top of the touch screen has four icons. Touch the **Mode** icon on the top left to clear data, begin measurements, print, and perform other functions. The **Title** is in the center and can be changed to match the name of the product being measured or any other desired title. The **Feature** icon allows you to change the active feature and/or display graphs of measured values. The **Measurement** icon allows you to change the type of measurements being taken. This icon indicates the measurement type currently selected.

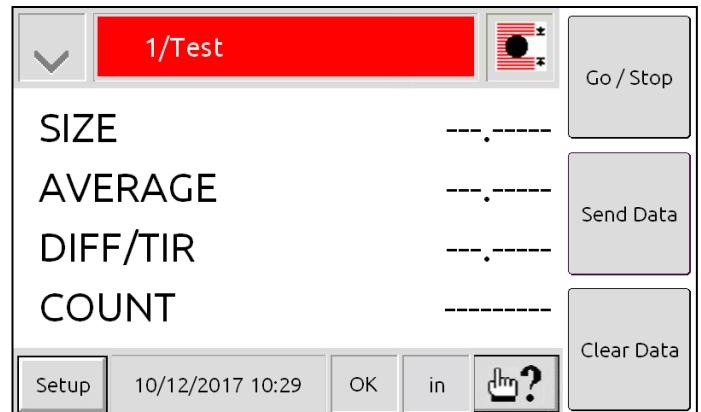

Only four measurement items are displayed at one time, but you can change the order and type of items by simply touching one of the items in the center of the display if you have [Advanced Screen options](#) are enabled.

If you wish one measurement item to be magnified on the screen to be visible from a distance, select Magnify from the menu, as shown. Touch the screen again to restore the screen to its previous display.

NOTE: Programmable functions identified by the characters Fxx, where xx is a number from 01 to 32. The Feature number appears between the Measurement Type icon and the Library block.

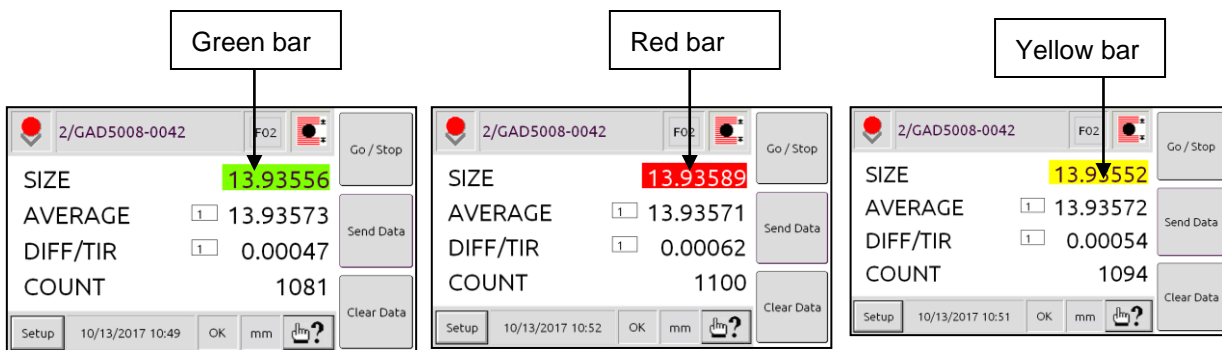
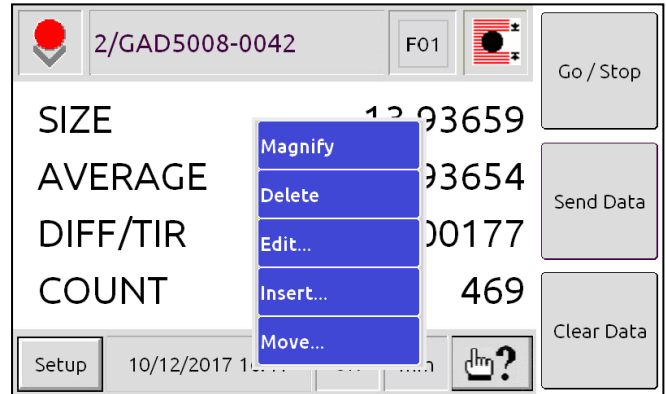

To indicate that product measurements have exceeded Warning or Reject limits, a colored bar will appear behind the out-of-limits measurement if the limits have been defined and measurements are being taken. The screens above show examples of measurements within all limits (green bar), measurements exceeding Reject limits (red bar), and measurements exceeding Warning limits (yellow bar), respectively.

The bar along the bottom of the touch screen contains several icons: **Setup**, **Quick Info**, **Status**, **Units**, and **Help**. Touch the Setup icon to access all the setup menus and parameters needed to alter the way data is processed and displayed. The Date/Time block allows you to define the current time and date.

NOTE: For more information about limits and warnings, see the Setup section, under [Warning Tolerances](#).

Touch the Quick Info block to access these three pages. You can specify the date, the time, and the display setting for Quick Info display from these pages.

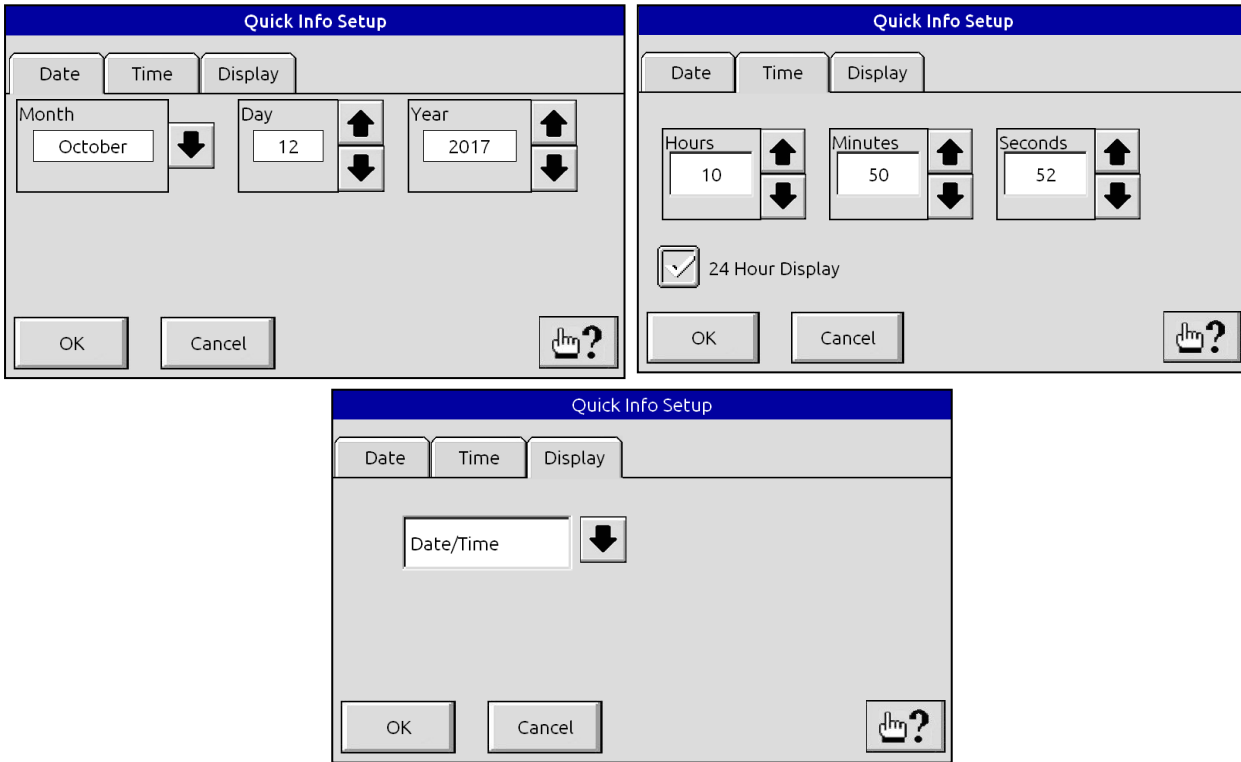

Selecting Flash will display the amount of flash storage available for library settings. Selecting RAM will display the amount of memory available to the software application.

The Status block on the main screen displays the current status of the scanning beam and tolerance/limit alarms. From the Status menu you can also access diagnostic information, lock the BenchMike Pro, and check the software revision in use. The Units icon allows you to select the desired measurement units. The Help icon accesses help menus to assist you with various functions of the BenchMike Pro. Touch the Help icon and then touch the item for which you need help, and a Help Page will appear.

4.2 Mode Icon and Menu

Note that the Mode icon changes based on the measurement mode in operation.

This icon indicates that measurements are not being taken and the BenchMike Pro has detected the correct number of part edges or segments.



This icon pulsates at the measurement update rate, indicating that measurements are being taken.



This icon indicates that no part is detected in the measurement area or the BenchMike Pro has detected an incorrect number of part edges or segments.



The black triangle in the red or green circle indicates the BenchMike Pro has been re-mastered. See the section on Re-mastering.



If you've entered a non-zero value for Thermal Compensation, the red or green circle will change to show a thermometer.



By touching the Mode icon in the upper left hand corner of the screen, you access several frequently-used functions of the BenchMike Pro, as shown to the right.

NOTE: Some options are only available with certain fixtures.

When the **Clear** command line is selected, three options can be selected. You can clear all accumulated data, clear the last measurement, or clear all latched alarm outputs. You will be asked to confirm this selection before the values are erased.

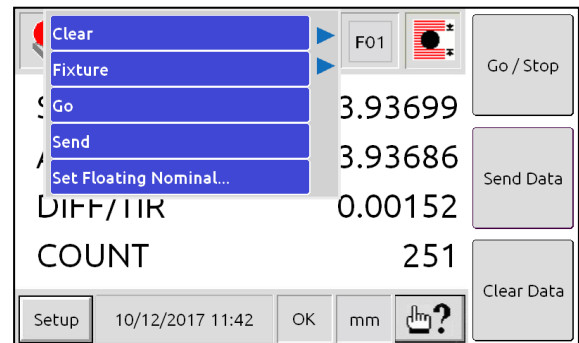

The **Fixture** menu allows you to zero the current position and return motorized fixtures to the home position.

When **Go** is selected, measurements are either started or stopped. The displayed measurement data will change as data is updated and processed. This function can also be accessed by pressing the Go data button on the front of the BenchMike Pro. Note that this option is displayed as Stop when the BenchMike Pro is in Go mode.

When the **Next Feature** command line is selected, the feature number increases by one. For example, if Feature 01 is selected, touching Next Feature will select Feature 02.

When the **Print** command line is selected, sample or batch reports are transmitted to the serial port or printer port. This option will appear grayed out if no printed reports have been selected.

When the Send command line is selected, the current measurements that have been selected for serial output are transmitted via serial port #1 and serial USB, both located on the rear panel of the BenchMike Pro. This function can also be performed by pressing the Send Data data button on the front of the BenchMike Pro. To allow data to be transmitted open the Setup->System->Communications Ports, under the Assignment tab, select the **Allow Measurement Data to be Sent** option.

The **Set Floating Nominal** allows you to set floating nominal to the current reading. See [Floating Nominal](#) in the Setup section, under Measurement Functions.

4.3 Feature Icon

Touch the **Feature** icon in the upper right hand corner of the screen to display the menu shown.

If you are using an Intelligent Fixture, you can also create Deviation/Variation Graphs. If you have a rotary fixture, you can also create a Rotary Graph (shown). If you do not have sufficient data for the Deviation or Variation graphs (shown as Dev/Var), those options will appear grayed out.

To move between the different graphs, touch the Feature icon and select the desired view.

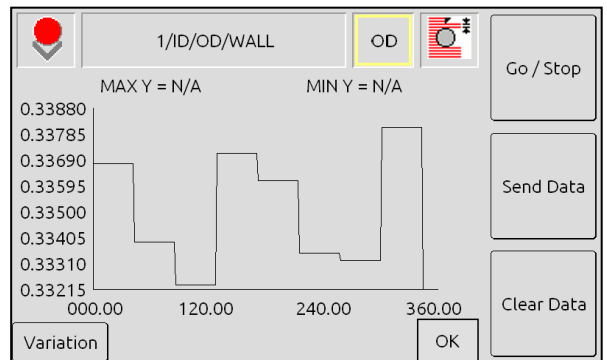
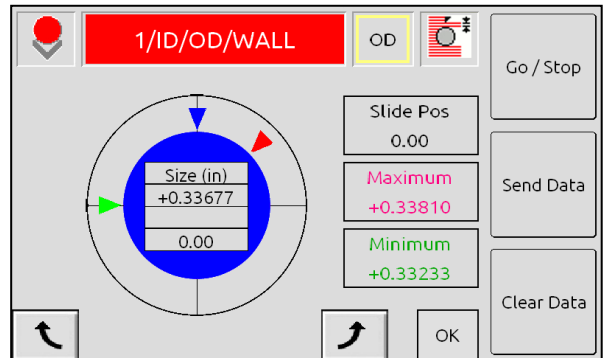
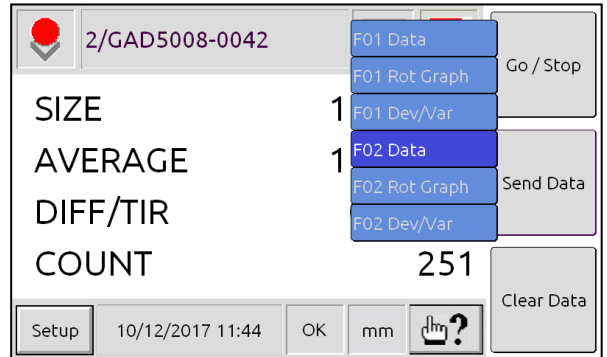

Deviation:

This graph shows the deviation from nominal at each position. For each position “deviation” is the measured size minus the nominal size entered by the user. The default nominal is 0.0.

Variation:

This graph shows the size variation between positions. For all but the final position “variation” is the absolute value of the difference between the next measured size and the current measured size. For the final position “variation” is the absolute value of the difference between the first measured size and the final measured size.

4.4 Measurement Icon

Touch the **Measurement Setup** icon in the upper right hand corner of the screen to display the menu shown. This icon allows you to quickly access the settings for measurement parameters. Note



that you can access these same screens by selecting Setup, then Measure, then Measurement.

See the [Measurement Functions](#) section in Setup for further information about these parameters.

Default settings are shown in the table below.

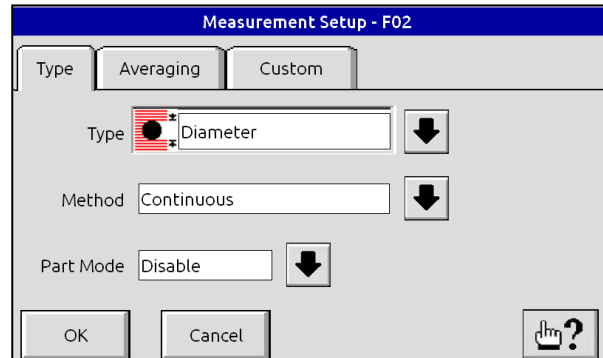

Tab	Parameter	Setting
Type	Type	Diameter
Type	Method	Single
Type	Part Mode	Disable
Averaging	Rate	2.00 Seconds
Averaging	Delay	0.00 Seconds

4.5 Setup Menu

Touch the **Setup** icon in the lower left hand corner of the screen to display the menu shown. From this menu you can access all setup functions of the BenchMike Pro.

Note that the order of options shown here indicates the hierarchical order of the commands. For example, System commands apply to all libraries. Library and Settings commands are unique to each library but are common to all the features within a library. Features, Measurement, and Data commands are unique to each feature within each library.

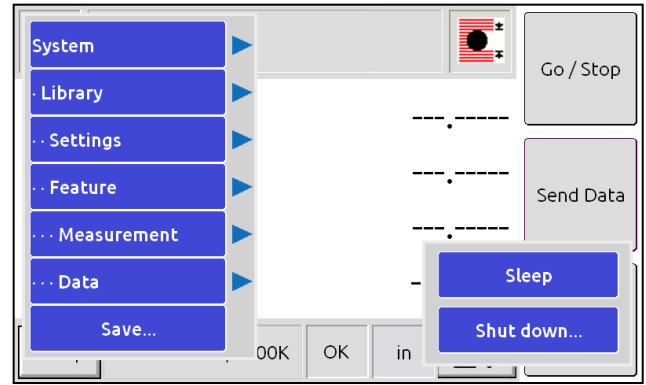

4.6 System Functions

NOTE: System commands apply to all libraries.

From the **System** menu, you can access the general system functions, such as the displayed date and time and settings for I/O ports.

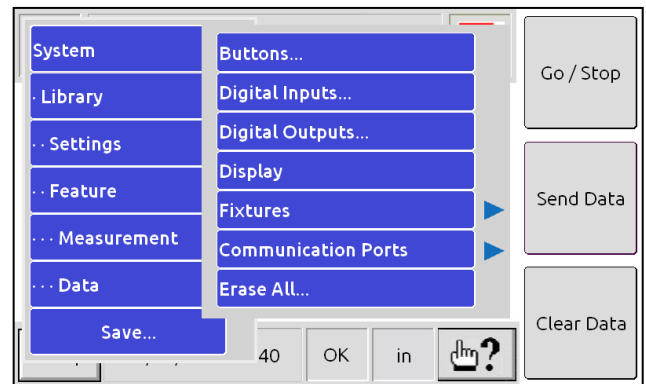

Using the **Button Setup** page, the three data buttons on the front of the BenchMike Pro can be redefined to perform different operations. The data buttons can be changed to the following functions:

- Off
- Go/Stop
- Clear Data
- Clear Last Data
- Print Data
- Send Data
- Clear Latched Outputs
- Floating Nominal
- Advance Feature
- Backup Feature
- Zero Fixture 1
- Zero Fixture 2
- Home Fixture 1
- Home Fixture 2

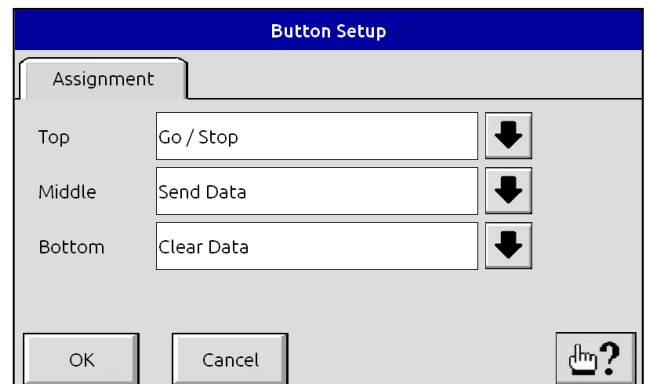

The information received via the **Digital Inputs** port of the BenchMike Pro is defined via the Digital Inputs page. The trigger for each input can be set to NO, NC, or Toggled. Each of the inputs can be defined separately. These inputs are:

- **Off**
- **Go/Stop**
- **Clear Data**
- **Clear Last Data**
- **Print Data**
- **Send Data**
- **Clear Latched Outputs**
- **Floating Nominal**
- **Advance Feature**
- **Backup Feature**
- **Emergency Stop**
- **Zero Fixture 1**
- **Zero Fixture 2**
- **Home Fixture 1**
- **Home Fixture 2**

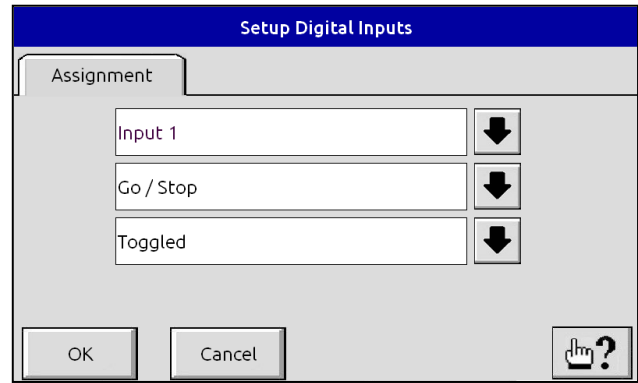

The **Digital Outputs** port pin assignment of the BenchMike Pro is defined via the Digital Outputs page. Positive or negative polarity can be selected. Digital output functions are user-assignable to specific digital outputs as desired by the user.

NOTE: Digital outputs are open-collector outputs, with maximum specs of 35 V DC and 250mA.

These functions are:

- **Off**
- **OK**
- **Good**
- **Reject High**
- **Warning High**
- **Warning Low**
- **Reject Low**
- **Scan Error**
- **Measuring**
- **End of Part**

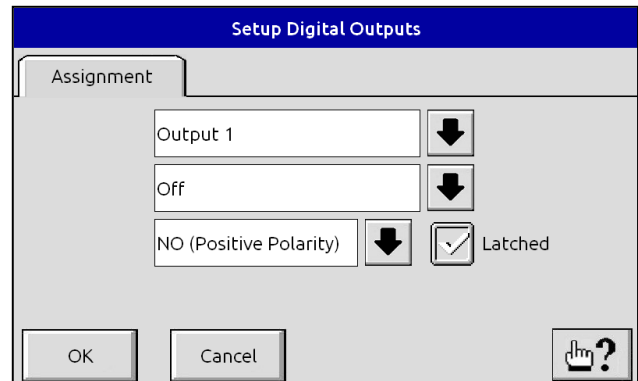

The **Display Setup** page allows you calibrate the touch screen.

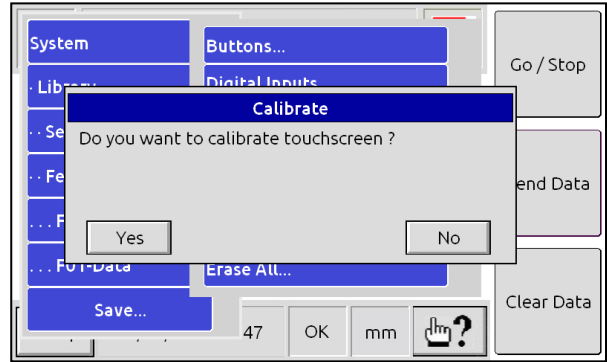

The **Fixture** Menu allows you to define the physical attributes of a custom fixture. Note that some fixtures appear to the BenchMike Pro to be two fixtures (as shown), typically as a fixture for each axis of measurement. For example, a linear slide with a rotary chuck will be displayed as two fixtures.

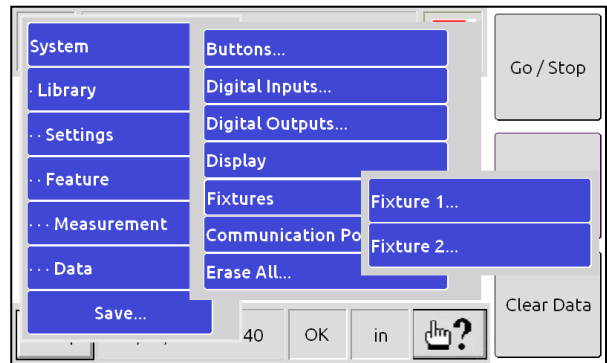

When an Intelligent Fixture is in use, you will be unable to change the Fixture Configuration. Settings will be displayed in read-only mode.

Ten configuration menus will appear. If you are not using an Intelligent Fixture, you will be able to enter and define the type of fixture to be used. Note that you can enter the name and functions of the fixture and store the values under that name for future use.

Setup 1 Tab

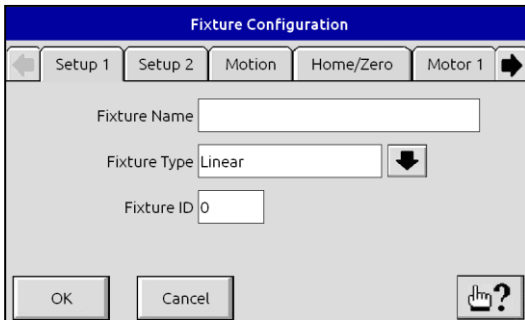

Setup 2 Tab

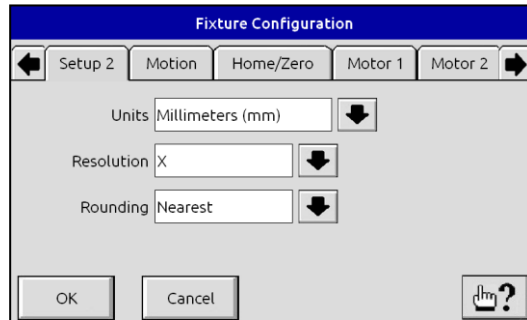

Motion Tab

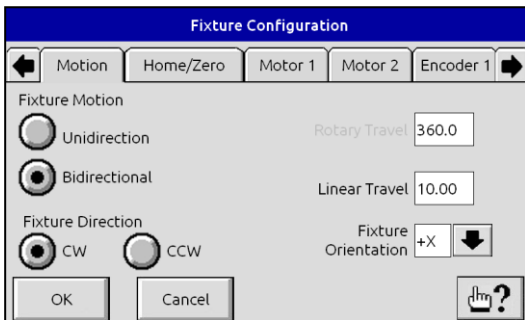

Home/Zero tab

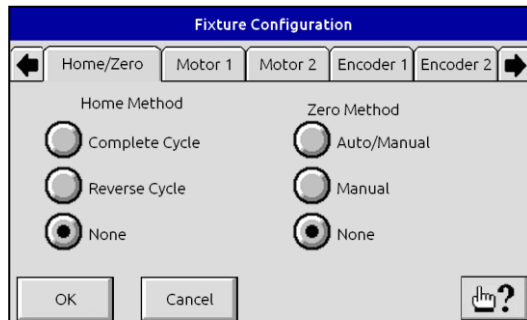

Motor 1 tab

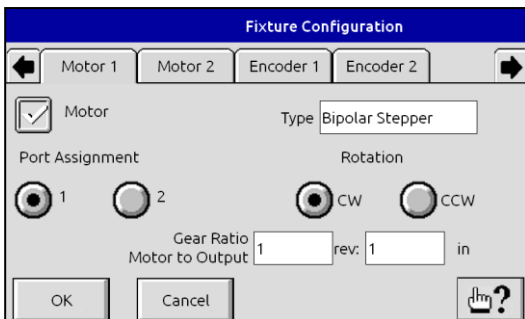

Motor 2 tab

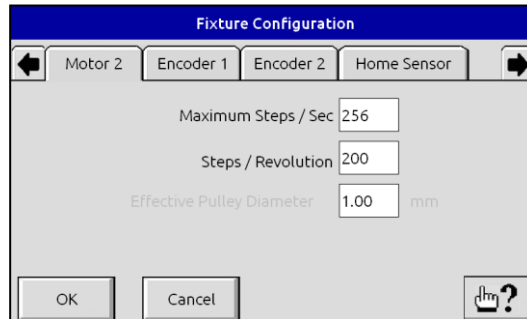

Encoder 1 tab

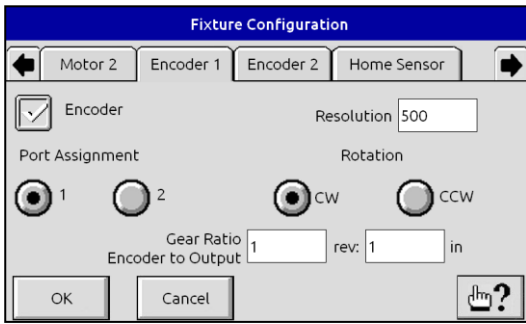

Encoder 2 tab

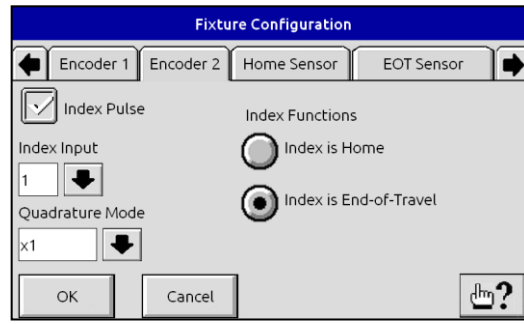

Home Sensor tab

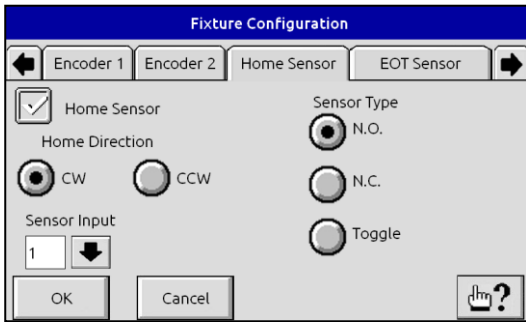

EOT Sensor tab

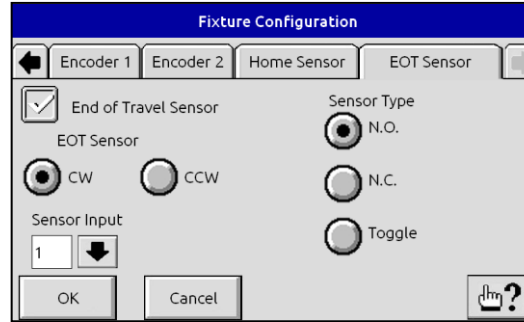

4.6.1 Communication Ports

The communication ports are a standard feature. The Communication Port Setup menus offer three tabs to customize the port for data transmission for serial port #1, serial USB, and Ethernet.

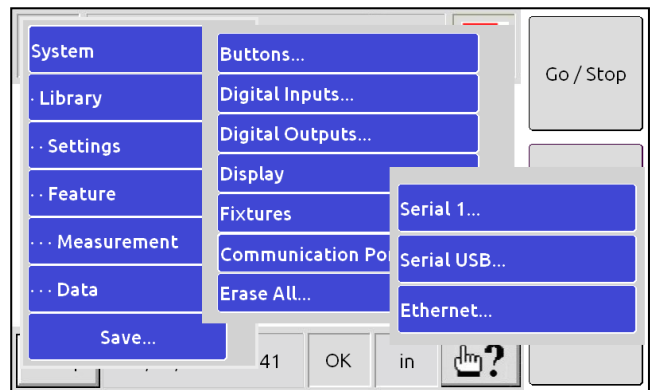

If you select **Serial port #1** or **Serial USB**, the following three tabs will appear.

The **Configuration** tab shown to the right allows you to select various communication features such as the baud rate and parity.

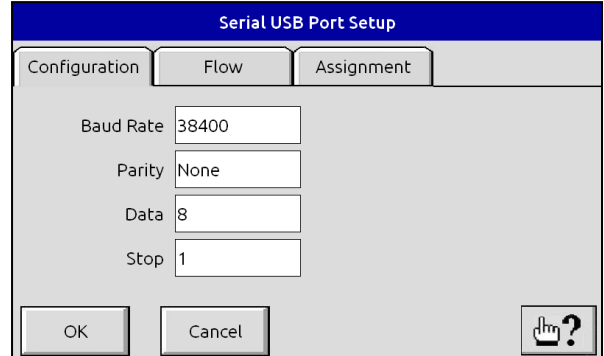

The **Flow** tab appoints the method in which data flow is controlled.

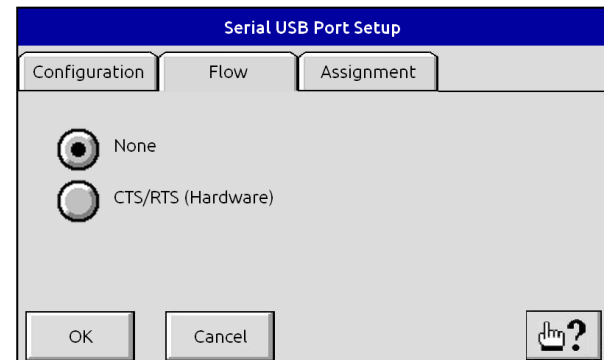

The **Assignment** tab offers options to enable or disable the receipt or transmittal of data, and to enable/disable Programmable Universal Resource Language (PURL) commands. These commands are used to for remote control and programming of the BenchMike Pro.

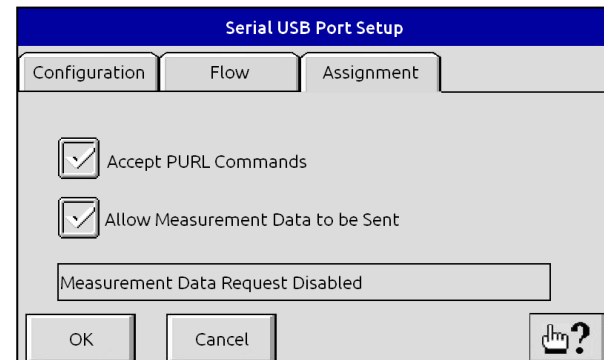

If you select **Ethernet**, the following three tabs will appear.

The **Wired** tab gives the option to set Ethernet parameters such as IP Address, Net Mask, and Gateway Address.

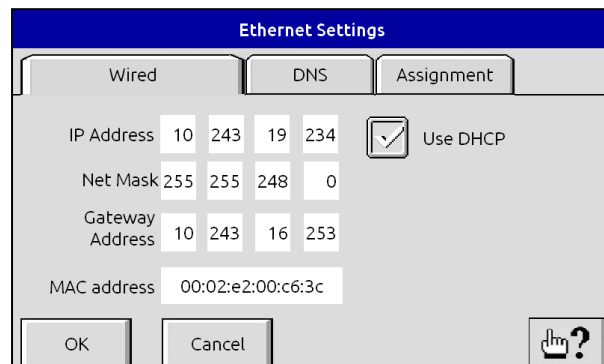

On the **DNS** tab, the Primary DNS Address and Secondary DNS Address can be changed.

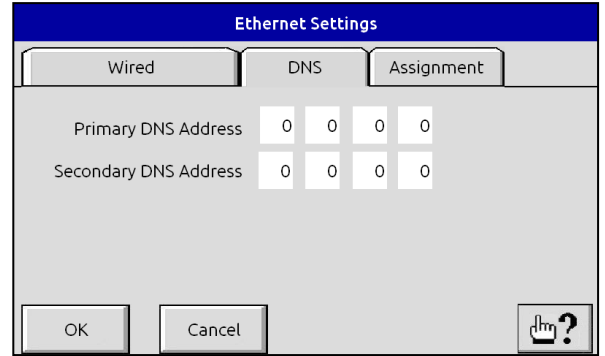

The **Assignment** tab offers options to enable/disable Programmable Universal Resource Language (PURL) commands. These commands are used to for remote control and programming of the BenchMike Pro. The Ethernet port to be used for connections is 8001. PURL commands on the serial port are not affected.

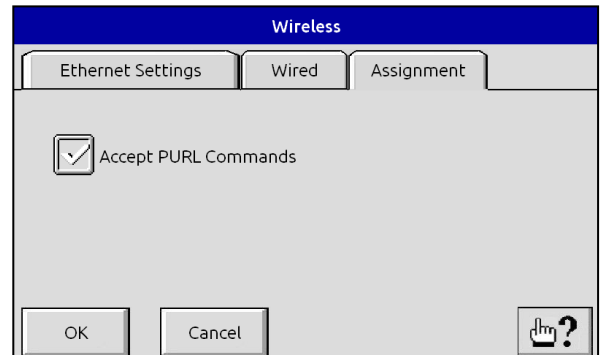

The last option from the System menu, **Erase All**, clears all user libraries and system settings, restoring the gauge to the factory default settings. You will be asked to confirm this selection twice because the change is irreversible.

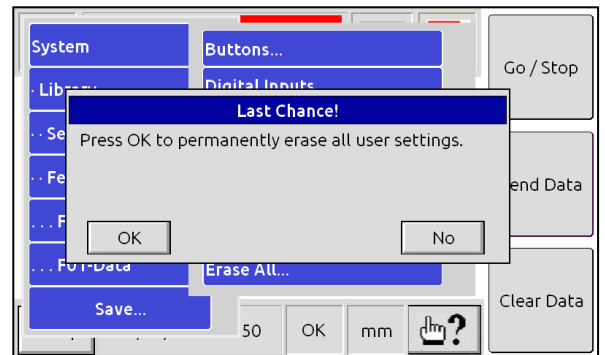

4.6.2 Sleep and Shutdown Functions

From the Setup menu, you can turn the BenchMike Pro to sleep or shutdown mode.

Selecting **Sleep** shuts off the BenchMike Pro's display LCD. Touch the screen anywhere to end sleep mode.

If you select **Shutdown**, you will be asked to confirm that you wish to shut down the BenchMike Pro. If yes, the BenchMike Pro will power down by itself. To restart the unit, press the power button on the back of the BenchMike Pro.

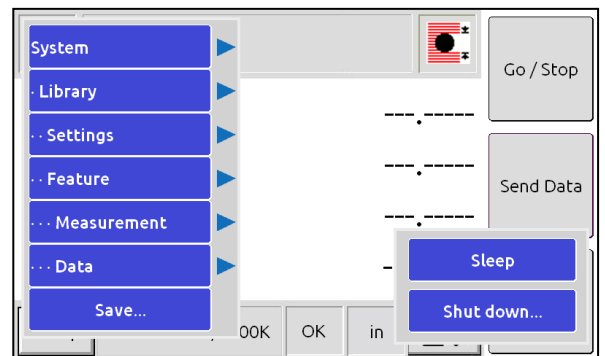

4.7 Library Functions

NOTE: Library commands are unique to each library but are common to all the features within a library.

The use of libraries allows you to store and recall, how the measurements are to be taken, and other system setup information into separate libraries. By defining libraries for each product or for different fixtures, you can shorten setup times for various parts or applications.

Touch the **Erase** option, and you will be asked if you wish to restore the active library to the factory default settings. All the settings in that library will be lost during initialization.

NOTE: The Erase option restores the active library to factory default settings.

Note that Erase removes the contents of the selected library from permanent storage. Initialize simply restores the contents of the current library to factory-defined defaults.

Similarly, **Initialize** is used to initialize the current library. Only the selected library will be initialized.

The **Name** option allows you to enter a name for your library with alphanumeric characters. Select the characters desired to name your library, and then touch the OK button to store the defined name. Note that uppercase characters are accessed by pressing the Up Arrow (shift) button. Library titles are limited in length to 15 characters.

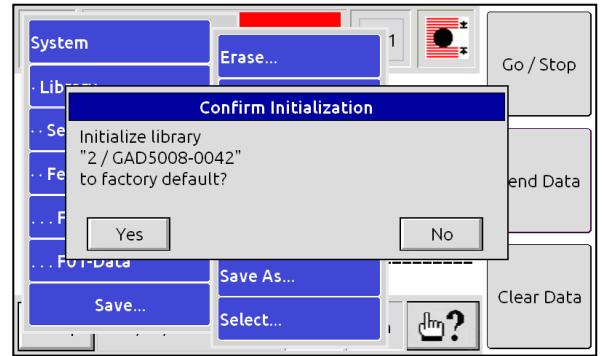
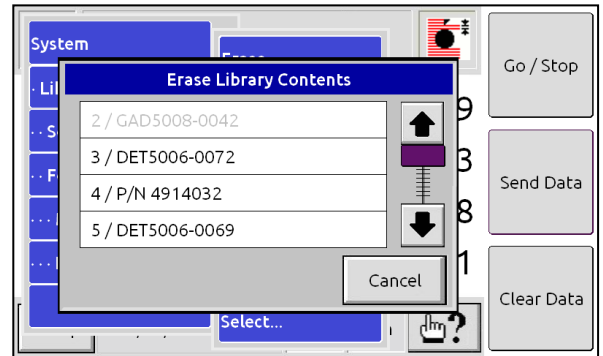
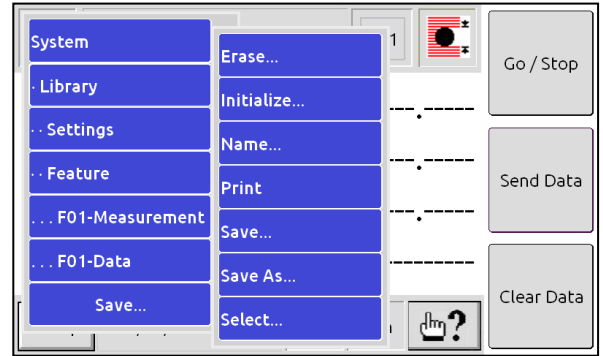

When you select **Print**, values for the currently active library will be sent as directed by the Reports Output setting.

NOTE: If the BenchMike Pro is turned off prior to saving the active library, all changes will be lost.

When you choose **Save**, a menu is displayed which asks you to confirm that you wish to save the changes you have made to the active library. Any changes you make to a library which are not saved will be lost when the BenchMike Pro is turned off.

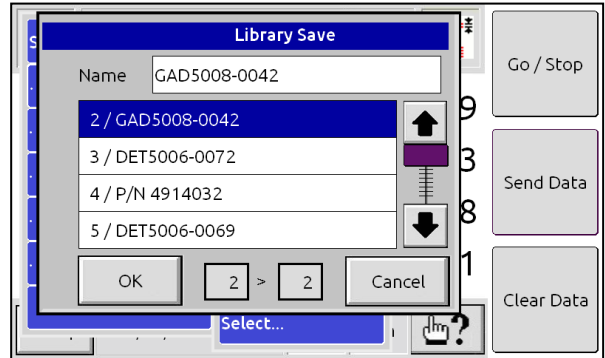

If you have made a change to your setup but have not saved the change by saving the library, the title bar will be highlighted in red, as shown. The red color will not change until you have saved the library.

NOTE: The title bar highlights red, reminding you to save changes to the library.

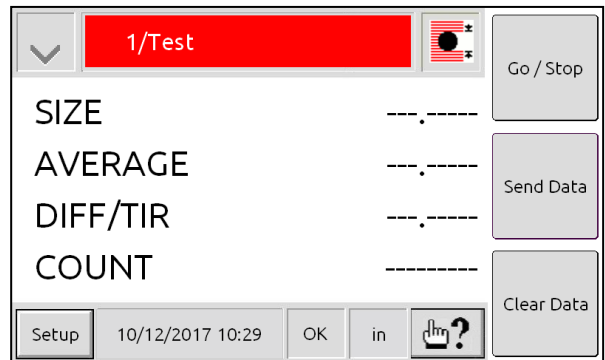

To save your changes to an existing library into a new library or save a new library, touch the **Save As** option. You can change the name of the library and save it to any library from this screen.

Shortcut: Touch the Library Title Block from the main measurement screen to display this screen.

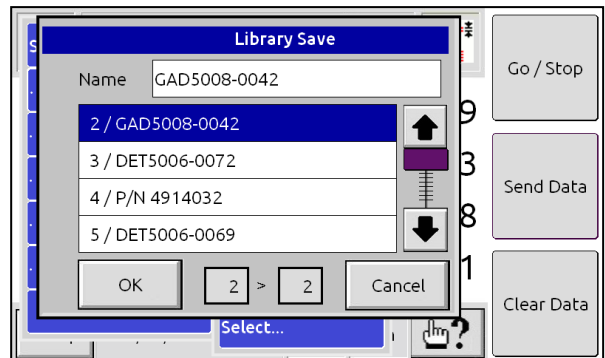

To move between libraries, touch the Select option from the Setup Library menu. Scroll through the list of libraries to select the desired one. Selecting the current library will restore the saved setting, overwriting any unsaved changes you have made.

4.8 Settings Functions

Touch Settings from the Setup menu to display the menu shown. This menu contains settings that are unique to each library.

NOTE: Settings commands are unique to each library but are common to all features within a library.

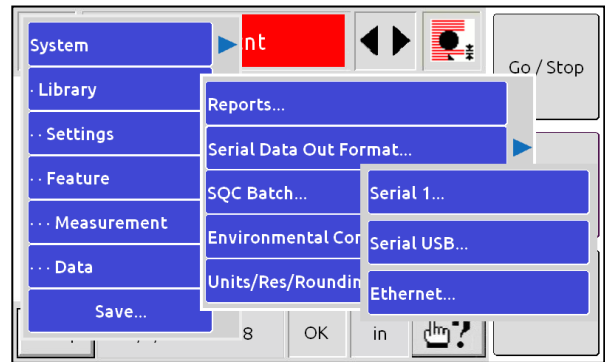

To access settings for printed reports, select **Setup**, then **Settings**, and then **Reports**. These pages allow you to define settings for report output via a dot matrix or inkjet printer.

There are three tabs under **Report Setup**. From the **Reports** tab, you can specify the type of report to be generated.

NOTE: Fixture Sample Reports and Fixture Part Reports are only available when you are using a fixture.

There are four types of reports available from this menu:

- Sample Report**
- Batch Report**
- Fixture Sample Report**
- Fixture Batch Report**

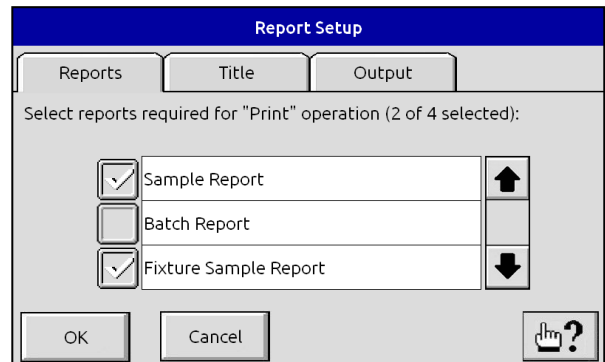

Use this **Title** tab to enter the desired title of your data report.

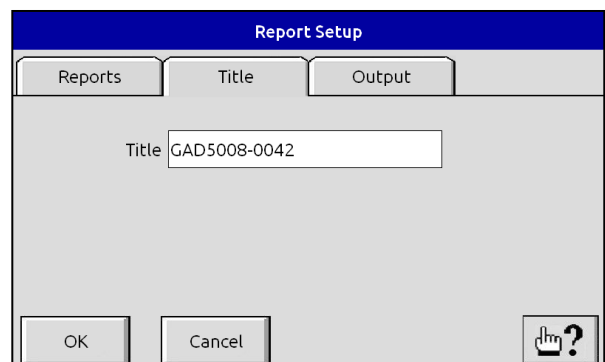

From the **Output** tab, you can set up your external printer for report printing. Specifically, you can define the output port to be used, and you can enable/disable the report form feed and report Header/Footer functions.

NOTE: You can select the Serial 1 Port, Serial USB, CUPS Printer, or Ethernet Port 8003 for report printout.

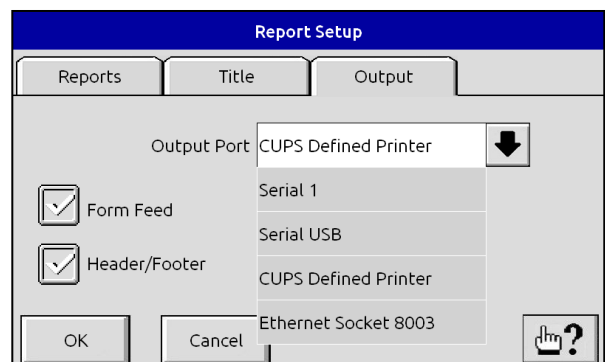

4.9 Reports

The key difference between Batch and Sample Reports is that Sample Reports can only be printed one time per sample, while Batch Reports can be printed multiple times by pressing the Print key. Sample and Batch Reports contain data from a single part measurement. If Continuous measurements are selected for Sample and Batch Reports (under the Measurement Setup Type tab), measurements will be taken until the Print key is touched or until the Reading Count equals the Batch Count value.

Fixture Sample and Fixture Batch Reports are generated when multiple measurements are made of one part, as performed by a fixture. A Fixture Sample Report will print at the end of each part measurement cycle. A Fixture Batch Report will print when the Batch Count equals the Part Count value or when the Print key is touched.

The following are samples of the four types of reports.

- The Sample and Batch Reports which follow are used when measuring samples with a V-Block or other simple measurement fixture. They are printed after all measurements have been taken by touching Print.
- The Fixture Sample and Fixture Batch Reports shown can be created when either a manual fixture or an intelligent fixture is used.

4.9.1 Sample Report

The Sample Report is designed for use when taking a single measurement of multiple parts.

NOTE: A maximum of 31 characters is permitted in the Title (shown as “Your Information Here”) line.

NOTE: The headers are optional and can be turned on and off on the Report Setup/Output page.

NOTE: This report is printed for each Feature that has been inserted in the library, causing the Feature number to be added to the report header. This report may be printed multiple times by selecting Print on the Mode icon drop-down menu.

Your Information Here	Sample Report
Library 03/Untitled/F01	06/30/2018 8:25a Page 1 of 1
Mode: Diameter, Units:Inches(in)	
Sample #1	0.1086
Sample #2	0.1003
Sample #3	0.0502
Sample #4	0.0430
Sample #5	0.1626
Sample #6	0.1046
Sample #7	0.0461
Sample #8	0.0457

4.9.2 Batch Report

The Batch Report is a companion report to the Sample Report shown on the previous page. It summarizes the statistical results for all the measured parts, as shown in the example below.

NOTE: A maximum of 31 characters is permitted in the Title (shown as "Your Information Here") line.

NOTE: The headers are optional and can be turned on and off on the Report Setup/Output page.

NOTE: This report is printed for each Feature that has been inserted in the library, causing the Feature number to be added to the report header. This report may be printed multiple times by selecting Print on the Mode icon drop-down menu.

Your Information Here		Batch Report
Library 03/Untitled/F01		06/30/2018 8:34a Page 1 of 2
Mode: Type 7, Units:Inches (in)		
Average	0.049816	
Diff/TIR	0.000006	
Maximum	0.049818	
Minimum	0.049812	
Standard Deviation	0.0000032	
Undersize Samples	0	
Oversize Samples	0	
Total Number of Samples	3	
Your Information Here		Batch Report
Library 03/Untitled/F02		06/30/2018 8:34a Page 2 of 2
Mode: Type 8, Units:Inches (in)		
Average	0.049957	
Diff/TIR	0.000005	
Maximum	0.049949	
Minimum	0.049954	
Standard Deviation	0.0000029	
Undersize Samples	0	
Oversize Samples	0	
Total Number of Samples	3	

4.9.3 Fixture Sample Report

The Fixture Sample Report is designed for use with automated part positioning fixtures, such as the Auto-Rotating Chuck Fixture. This report is automatically printed one time at the end of the fixture measurement cycle. Note that there is no header for this report.

NOTE: A maximum of 31 characters is permitted in the Title (shown as "Your Information Here") line.

0.351379 0.356977 0.362025 0.359710 0.350075 0.353630 0.357084
0.354713

MAX: 0.362025 MIN: 0.350075 DIFF: 0.011950 AVG: 0.355699 SD: 0.0040568
READINGS: 8

4.9.4 Fixture Batch Report

The Fixture Batch Report is a companion report to the Fixture Sample Report shown on the previous page. It summarizes the statistical results for all the measured parts.

NOTE: A maximum of 31 characters is permitted in the Title (shown as "Your Information Here") line.

Your Information Here Library 03/Untitled/F01	Fixture Batch Report 06/30/2018 8:40a Page 1 of 1
Mode: Diameter, Units:Inches(in)	
Report on All Readings	
Average	0.355690
Std Dev	0.0036261
Highest	0.362025
Lowest	0.350075
Range	0.011950
Oversize	0
Undersize	0
Report on Sample/Part Summaries	
Average	0.355616
Std Dev of Sample Averages	0.0001111
Highest Sample Average	0.355699
Lowest Sample Average	0.355490
Highest-Lowest Sample Average	0.000209
Average Range/R-Bar	0.010957
Oversize Samples	0
Undersize Samples	0
Total Number of Samples	8

4.9.5 Rotating Fixture Batch Report Data Flow

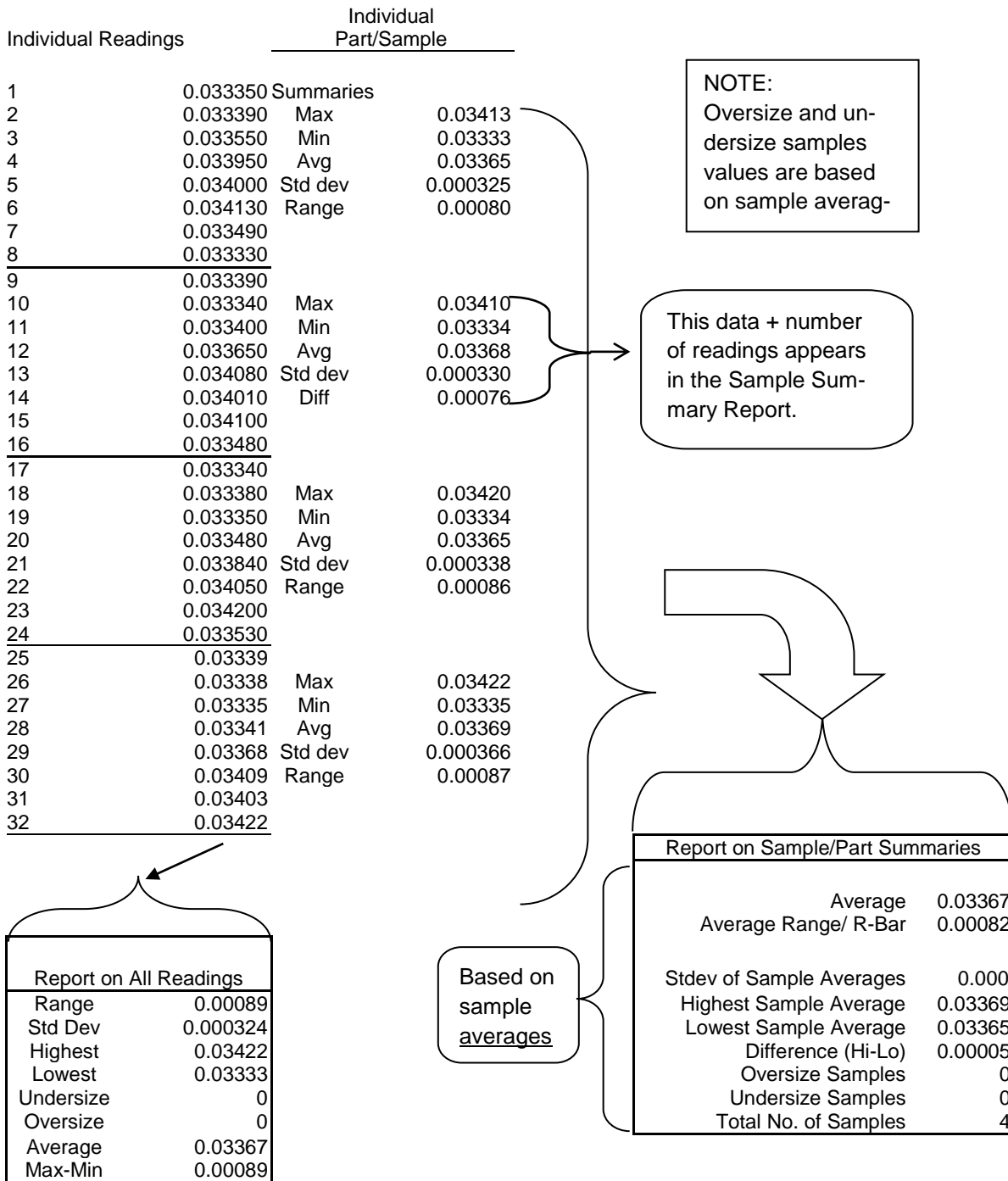

4.9.6 Serial Data Out Format

The **Serial Data Out Format** menu also accesses the Data Format, Data Flow, and Number Format tabs, which allow the format of serial output to be easily changed. Many data values can be transmitted through the serial ports, as listed below:

NOTE: Serial output data values are selected from the Setup - Data... Menu, and each item has its own menu. Check the desired option from that menu to enable transmission of the item from the serial port.

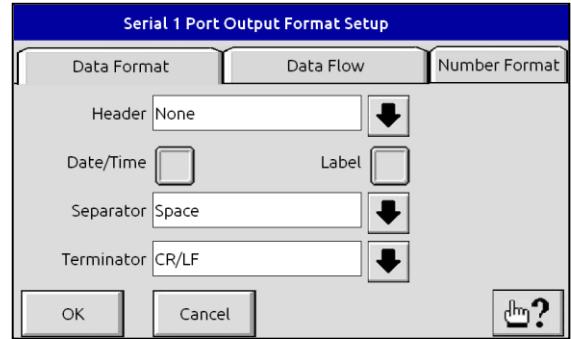

Parameter options from the Data Format tab are listed below. Note that the serial port #1 or the serial USB must be set up as described under [Serial Port #1](#).

Item	Description	Options
Label	Name of transmitted data (Deviation, Size, etc.)	Enabled, Disabled
Header	Character sent at beginning of each line	None, SOH (ASCII 001), STX (ASCII 002), ! (ASCII 033)
Date/Time	Current date and time	Enabled, Disabled
Separator	Inserted between multiple columns of data	Space, Comma, Semicolon, CR, LF, CR/LF, Tab
Terminator	Sent after last output	None, CR, LF, CR/LF, (ASCII 003)

The second tab under **Serial Output Format** allows you to control the flow of data to the serial output. You can enable or disable the Autosend feature, specify a minimum time period for Autosend, and select a request character from default settings. The Measurement Request Character can be sent to the BenchMike Pro to remotely start the measurement process. This function must be enabled in the serial port settings from the Setup → System → Communication Ports Menu. Options for Measurement Request Character are:

- **CR (ASCII 013)**
- **ENQ (ASCII 005)**
- **? (ASCII 063)**

NOTE: The Meas Request Character option only appears for the Serial 1 or Serial USB option, not for Ethernet connections, as shown.

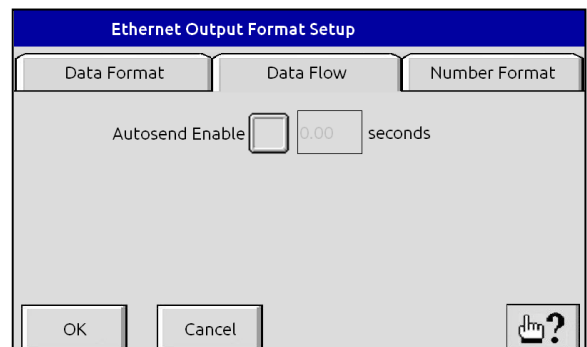
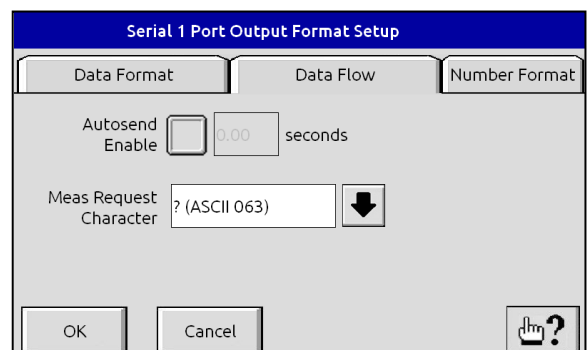

This screen allows you to display a +/- sign in front of numerical values sent through the serial port. If not selected, only negative numbers will include a sign. Note that the second option is used to change the format of sent data. When checked, a period will be used to indicate a decimal point in the data. When not checked, a comma is used.

NOTE: These settings only affect the format of data sent via the serial port. Note that the second option is only applicable for non-English users. While English uses a period to indicate a decimal place, some other languages use a comma, and those users may wish to alter this setting, based on data acquisition software requirements.

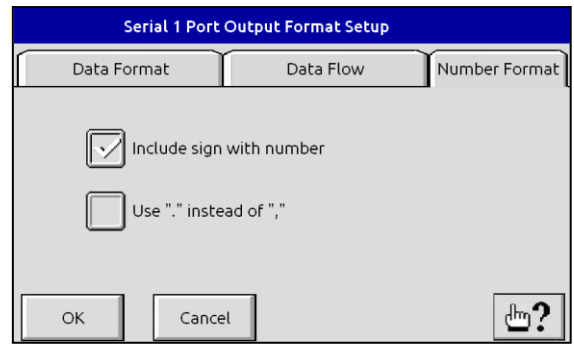

4.9.7 SQC Batch Setup

Note that the **SQC Batch Setup** page allows you to define the Batch Count value and decide whether to clear data and/or print reports at the end of the batch.

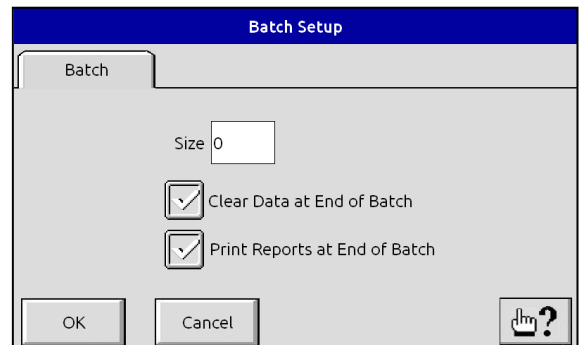

4.9.8 Environmental Compensation Setup

The **Thermal Compensation Setup** tab allows you to define temperature information so that the BenchMike Pro will automatically compensate for temperature differences. When Thermal Compensation is active, a thermometer icon will appear over the part icon in the upper left corner of the screen. All measurements will then be the theoretical value referenced to the "Standard Temperature".

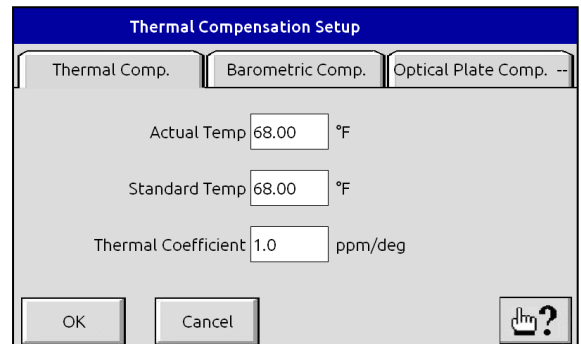

The **Barometric Compensation Setup** tab shows actual barometric values. The pressure at the time of calibration is shown as a comparison to the actual pressure at the time of measurement. The barometric calibration compensation values are entered at the time the unit is calibrated by qualified service personnel.

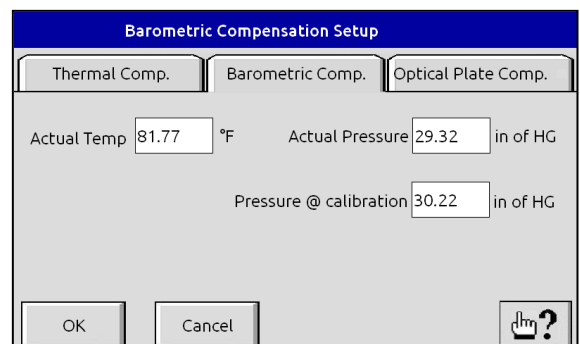

The **Optical Plate Compensation Setup** tab shows the optical plate temperature. This is a “read only” value from a sensor on the optical plate. The CPU temperature is a “read only” value of the temperature of the computer inside the BenchMike Pro.

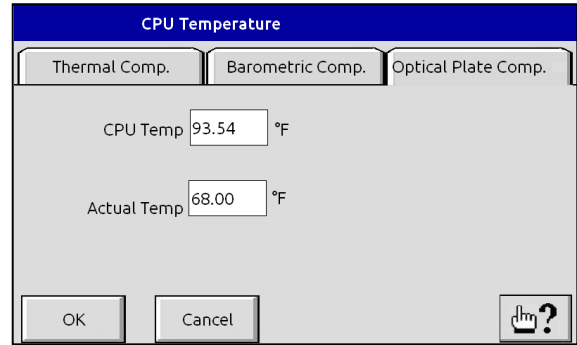

4.9.9 Units/Res/Rounding

The **Units** screen is used to define the measurement units displayed at the bottom of the main measurement display. Options include centimeters, millimeters, microinches, inches, and microns. The Units setup menu can also be accessed by touching the Units icon on the lower right of the main measurement display.

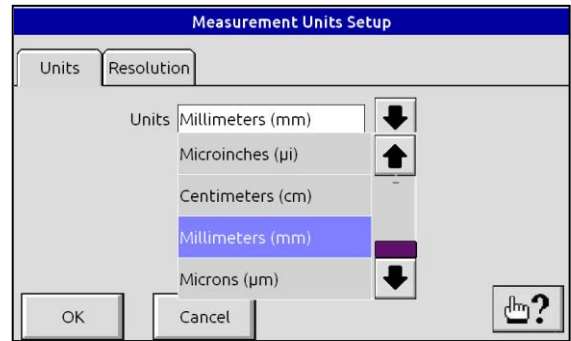

The second tab allows you to define the **Resolution** and **Rounding** values. The number of significant digits (from X.1 to X.123456) is displayed for each measurement value according to the Resolution parameter. You may wish to change this value based on the measurement units used. Measurements are rounded to match the specified resolution according to the Rounding parameter. Values can be rounded to the nearest value, to the nearest even value, to the nearest 0 or 5, or rounding can be turned off.

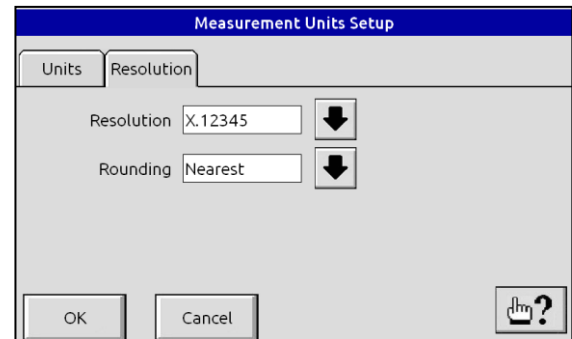

NOTE: Units can be changed from the Setup -Settings function.

4.10 Feature Functions

Features are similar to libraries, in that settings can be saved and stored for repeated use. However, features are different from libraries in that they permit you to develop more complex setups for your applications. Features allow you to link data between one another, unlike libraries, which function independently. Up to 32 features are stored in each *library*.

NOTE: Features commands are unique to each feature within each library.

To move between features, you can also select the Feature icon in the upper right hand corner of the touch screen. The Feature menu allows you to move between data values and graphs of the measured data.

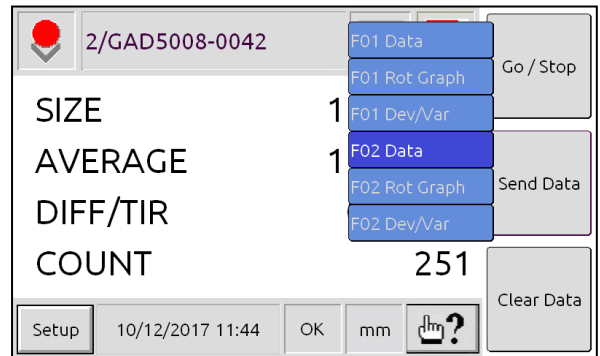
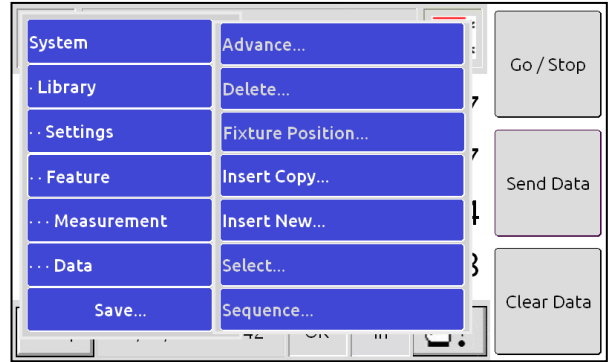

From **Advance**, you can define conditions which will cause the BenchMike Pro to proceed to the next Feature. A time delay can also be defined for this purpose. The Advance drop-down menu lists possible conditions, such as:

- **Go:** Advance when Go command is issued
- **End of Measurement:** Advance when a measurement is completed
- **End of Measurement (in Limits):** Advance when a measurement is completed if the measurement is within defined limits
- **Manual:** Advance with digital inputs or when you select a new feature

The **Insert Copy** function copies the current feature and inserts it after the last feature. A maximum of 32 features may be defined.

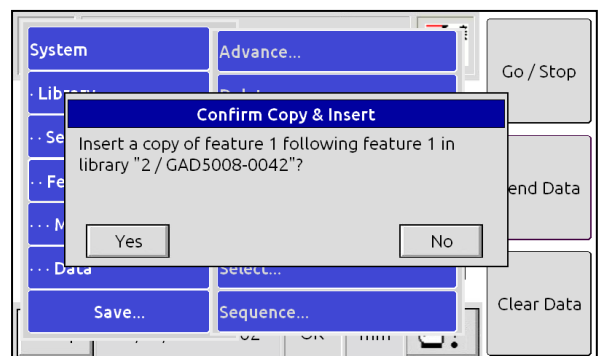
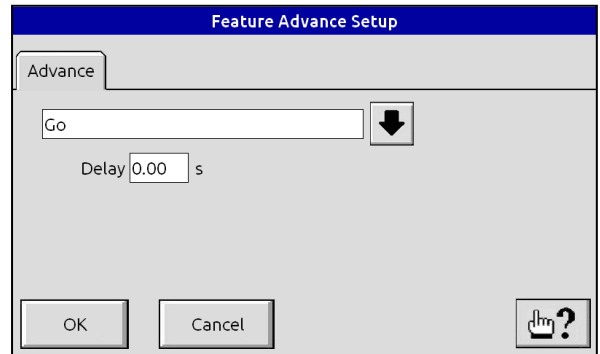

The **Delete** function deletes the current feature. You will be asked to confirm that you wish to delete the feature.

Shortcut:

Touch the Feature number (shown here as F01) to display this screen.

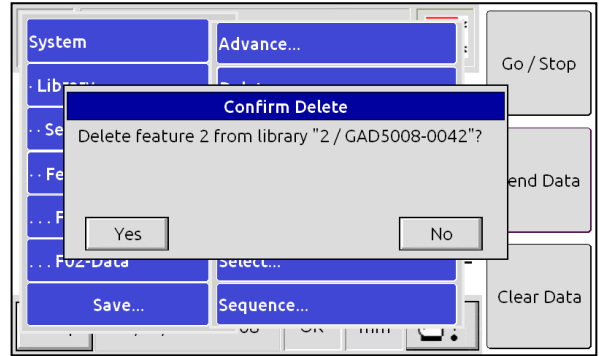

You can create a new feature with the **Insert New** function. By default, the new feature will be created in the current library, following the current feature. You will be asked to confirm that you wish to create a new feature.

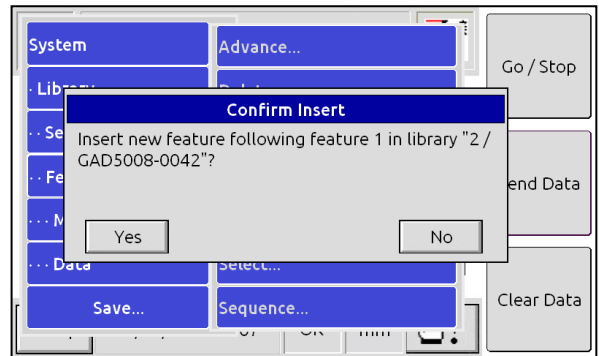

To move between features, touch the **Select** option. You can choose to move forward or backward through the features you have defined.

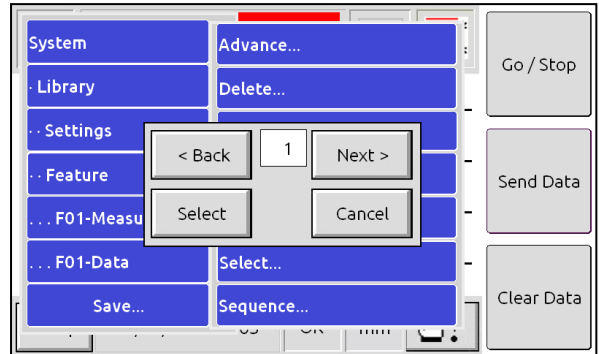

With the **Sequence** function, you can determine the order in which Features are performed. You can choose Sequential or Simultaneous Sequences, as shown.

In Sequential mode, measurements are only performed on the current Feature.

In Simultaneous mode, all Features within the current library will take measurements and display results concurrently. For this reason, all Features for Simultaneous mode will use the measurement type defined in Feature 1. Fixture measurement settings from Feature 1 will also be used in Simultaneous mode.

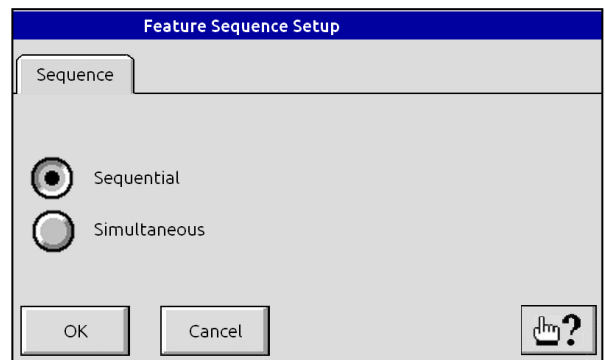

4.11 Measurement Functions

By selecting the **Measurement** option, you can define expressions, settings for fixtures, measurement types, nominal/limit/tolerance settings, the floating nominal value, and a user master value. When multiple Features exist, measurement settings are unique to each.

NOTE: Measurement commands are unique to each feature within each library.

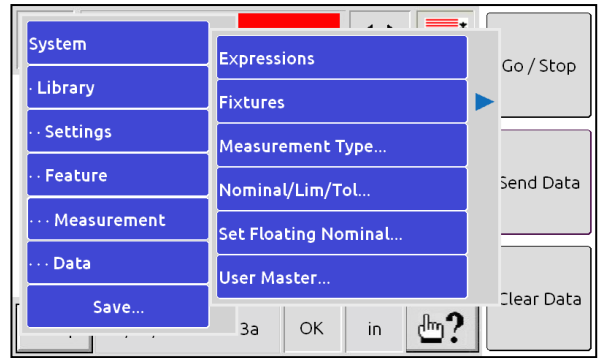

4.11.1 Expression Editor

You can define equations or desired calculations with the [Expression Editor](#). The default expressions for all predefined measurement types cannot be changed.



4.11.2 Fixtures Menu

The **Control** menu allows you to access the Fixture Measurement Setup page.

From **Fixture 1** and **Fixture 2**, you can control fixture measurement settings and access settings for different fixtures.

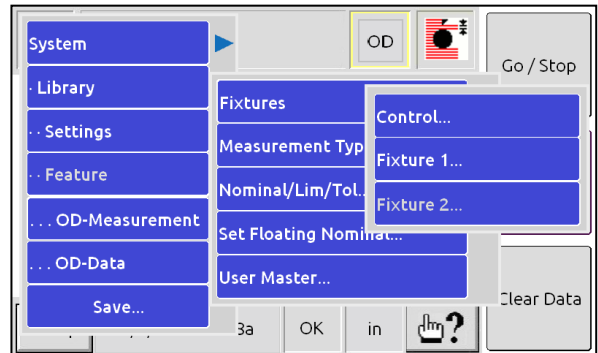

When you select **Control**, the **Fixture Measurement Setup** menu appears. Use the **Use Fixture to Collect Data** entry to define how the fixture behaves during measurement. Note that this item is enabled if at least one attached fixture is motorized. The fixture used to collect data is the primary fixture for obtaining readings.

If a motorized fixture is being used, you can choose to have the BenchMike Pro take measurements automatically (according to your Position and Motion values), manually, or continuously. Non-motorized fixtures only support the manual mode.

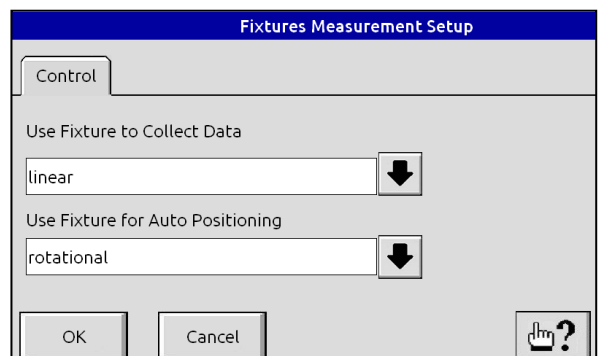

Auto positioning fixtures

The fixture used for auto positioning is a slave to the fixture which is collecting data. The fixture will move between taking measurements. This option is enabled if both attached fixtures are motorized. Measurement is initiated by the Go command. At the end of each averaging period (defined in Measurement Setup), the fixture rotates to the next position and takes measurement data. The number of measurements may be from 2 to 360 and can be entered as a number of positions or as the angular increment between positions. Measurements are not taken during rotation.

Manual rotating fixtures

Measurement is initiated by the Go command. At the end of each averaging period (defined in Measurement Setup), the user is prompted to rotate the sample to the next position and press Go to take the next measurement. Graphical displays are not available in this mode because the position is not known reliably unless the fixture has a position encoder.

When a linear fixture is selected as the positioning fixture, the “Feature” option will appear. This option will allow the user to enter a specific position for the fixture. The actual position is entered using the Feature Fixture Position page.

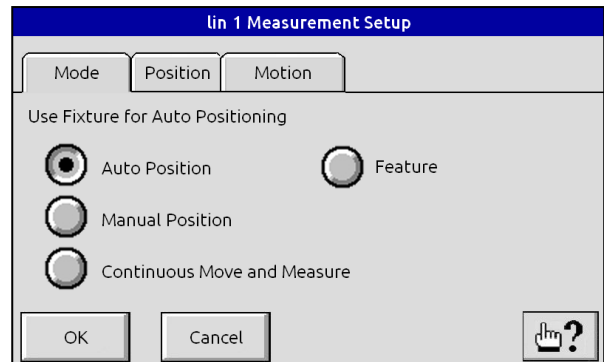

Continuous

For automatic rotating fixtures: Measurement is initiated by the Go command. Measurements are captured while the fixture is rotating. This mode can be used to capture the Maximum, Minimum, or Maximum-Minimum (Diff). The user enters the speed and amount of rotation. Graphical displays are not available in this mode.

The **Position** tab allows you to define either the number of positions (from 2 to 360) or number of degrees of rotation (from 1 to 360). You can also select total degrees of rotation values of: 360, 180, or a custom value. Note that there are four modes.

Two-fixture movement

When two fixtures are selected for movement, the **Manual** option is not available for selection. The fixture that collects measurement data is the Collection Fixture, and the fixture that moves the product into position is the Positioning Fixture.

When the Collection Fixture is configured for **Automatic** movement – which is essentially a stepwise movement – and the Positioning Fixture is also configured for **Automatic** movement, the two fixtures will move in step. The Collection Fixture will move first, and it will then wait for the Positioning Fixture to move to its first position. Once in position, the measurement will take place. The number of positions for the Collection Fixture will dictate the number of measurements to be taken.

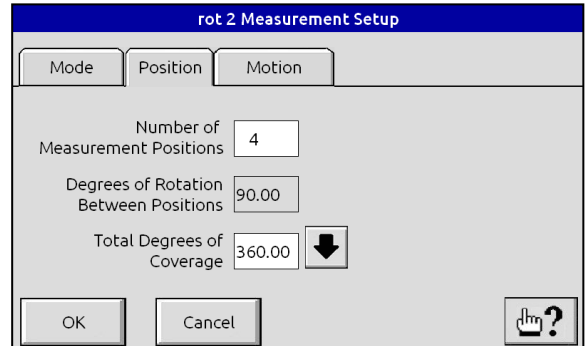

rot 2 Measurement Setup

Mode Position Motion

Number of Measurement Positions 4

Degrees of Rotation Between Positions 90.00

Total Degrees of Coverage 360.00 ↓

OK Cancel ?

For example, if there are four steps defined for the Collection Fixture and two steps defined for the Positioning Fixture, the Positioning Fixture will be moved twice, and will then stop moving for the last two measurements of the Collection Fixture. Once the Collection Fixture has completed the four defined steps, the two fixtures will move to the Home position, if so selected.

When the Collection Fixture is configured for **Automatic** movement – which is essentially a stepwise movement – and the Positioning Fixture is configured for **Continuous** movement, the two fixtures will move at the same time. The Collection Fixture will move first, and then the unit will start moving the Positioning Fixture to its final position at the rate specified. Once in position, the measurement will take place. The number of Collection Fixture positions will dictate number of measurements taken.

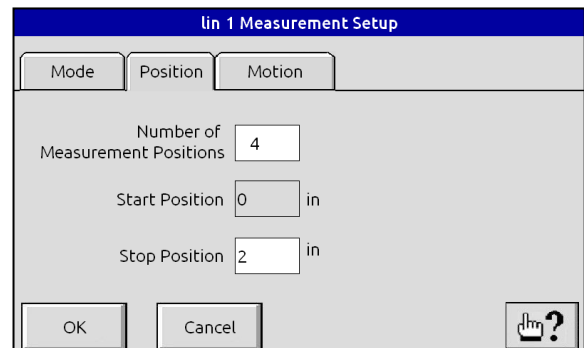

lin 1 Measurement Setup

Mode Position Motion

Number of Measurement Positions 4

Start Position 0 in

Stop Position 2 in

OK Cancel ?

For example, if there are four steps defined for the Collection Fixture but the Positioning Fixture movement only lasts for two steps of the Collection Fixture, the Positioning Fixture will be moved during the first two steps and then stop moving for the last two Collection Fixture measurements. Once the Collection Fixture has completed the four steps, the two fixtures will move to the Home position, if so selected. If the Positioning Fixture was programmed to move for a longer time that the Collection Fixture moves, it will be stopped at the end of the Collection Fixture's movement. After the Collection Fixture has stopped moving, both fixtures will move to the Home position, if so selected.

The **Feature** position movement mode of the Positioning Fixture can be used to measure different positions in a part. In this mode, the Collection Fixture is subordinate to the Positioning Fixture. The Positioning Fixture will move to the location specified in the feature, and then the complete movement of Collection Fixture will take place.

For example, you can specify a different position in three features and select the Collection Fixture to move either **Automatically** or continuously for each of those three positions. When **Go** is pressed, the unit will start with the first feature's position and start measuring as the Collection Fixture is set up. When the Collection Fixture cycle is finished, the unit will proceed to the next feature. This will continue until the last feature or, optionally, when the Feature Advance Mode can be set to **End of measurement within limits**. When configured in this manner, the unit will stop measuring when an out of tolerance condition is encountered.

Pressing **Clear** or **Stop** before the measurement cycle is completed will stop the fixtures at the current location and they will move to the **Home** position, if so selected.

The **Motion** tab allows you to select the desired values for the following.

- **Motion Speed:** Sample rotation speed
- **Enable Half-Stepping:** Permits smoother sample rotation
- **Home Fixture and End of Meas Cycle:** Returns fixture to starting position at end of cycle
- **Disable Motor After Movement:** Turns off fixture's motor at end of cycle

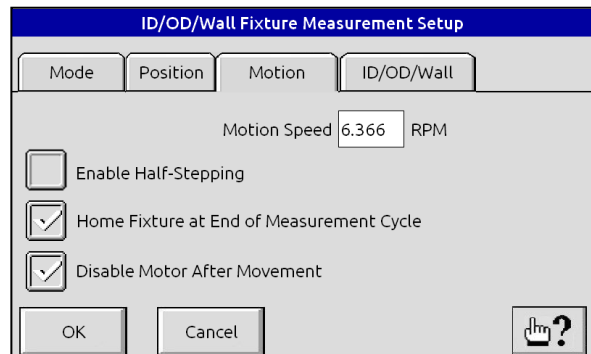
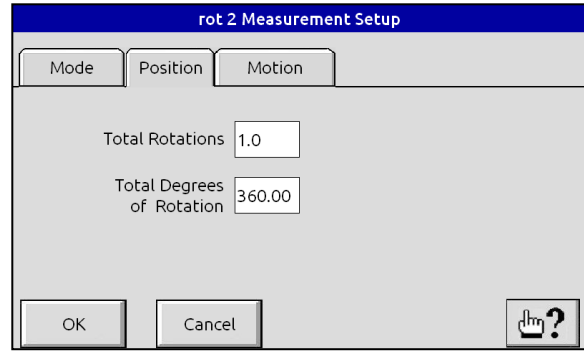

4.11.3 Measurement Type

Eighteen measurement types are available. Options include simple diameter measurement, measurements of multiple parts, or measurements of transparent products. All available measurement types are shown below.

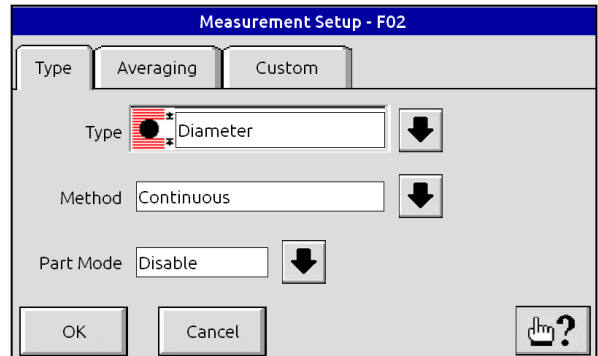
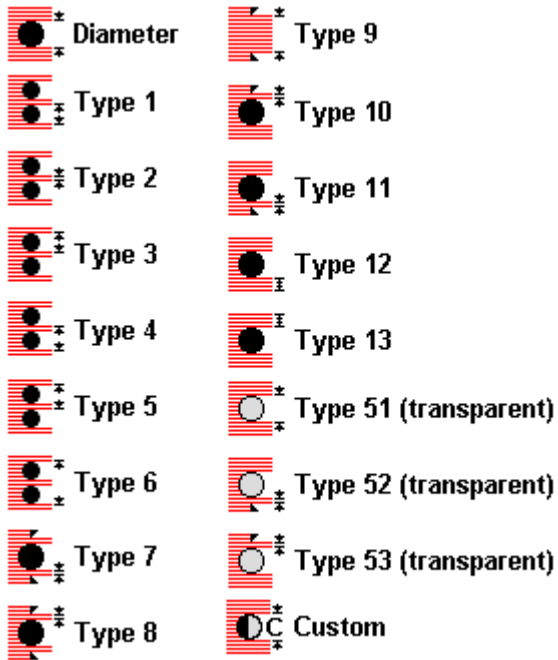

Each time the laser beam passes over the product, the BenchMike Pro records the product size as a scan. For greater accuracy, the BenchMike Pro groups these scans together to compute a reading. Each measurement reading is displayed on the BenchMike Pro's screen.

You specify how to compute and display the readings through three Measurement Setup tabs. Measurement settings can be accessed through the Measurement Type, Averaging, and Custom tabs. Note that on the Type tab only, the Measurement Type can be changed when an Intelligent Fixture is used.

Name	Description
Diameter	Diameter of product
Type 1	Diameter of lower product (2 products in beam)
Type 2	Distance between 2 products
Type 3	Diameter of upper product (2 products in beam)
Type 4	Distance from lower edge, lower product to lower edge, upper product
Type 5	Distance from upper edge, upper product to upper edge, lower product
Type 6	Distance from upper edge, upper product to lower edge, lower product
Type 7	Distance between lower edge of product and lower reference edge
Type 8	Distance between upper edge of product and upper reference edge
Type 9	Distance between two reference edges
Type 10	Distance between upper reference edge and upper edge of product
Type 11	Distance between lower reference edge and lower edge of product
Type 12	Distance between lower edge of beam and lower edge of product
Type 13	Distance between upper edge of beam and upper edge of product
Type 51	Diameter of transparent product
Type 52	Reference edge to lower edge of transparent product
Type 53	Distance between reference edge and upper edge of transparent product
Custom	Customized measurement; see description on following page

4.11.4 Measurement Method

There are three options for Measurement Method: Single measurements, Continuous measurements, and Moving Average.

- When **Single** measurements are selected, the BenchMike Pro will take one reading and then stop.
- When **Continuous** measurements are selected, the BenchMike Pro will take multiple readings until stopped by the user.
- When **Moving Average** measurements are selected, the BenchMike Pro will use the simple moving average method to continuously average the most recent X number of scans until stopped by the user. The user-defined Averaging Period is used as the averaging window, and the display rate is 5 readings per second, regardless of window size.

4.11.5 Averaging Mode

Averaging Mode is also present on this tab. This mode allows you to start taking measurements automatically when a new part is placed in the measurement area. Averaging Mode applies an Enter Delay and an Exit Delay to allow time for each part to be placed and removed.

This tab allows you to define the **Averaging Rate** and **Delay** values. The Averaging Rate can be specified based on a number of scans or a length of time in seconds. For the values shown to the right, the BenchMike Pro would accumulate scans for 2.00 seconds and then average that data to compute the reading value. When selecting a small averaging rate, it is best to select an even number of scans.

NOTE: This mode cannot be enabled when an Intelligent Fixture is in use.

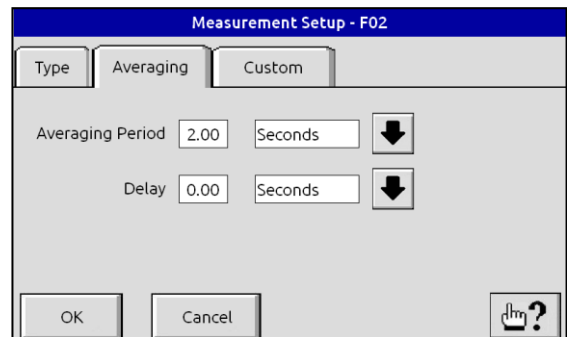

4.11.6 Custom Mode

For further information, see the section on [Measuring a Product](#). Since the BenchMike Pro scanning rate is 100 scans per second, a 2.0-second Averaging Rate corresponds to 200 scans.

The **Custom** tab allows you to create your own measurement definitions. If you do not find a measurement type (see previous page) which meets your requirements, you can use the Custom Wizard to create that measurement type or select Edit to perform simple changes. See also [Custom Measurement](#).

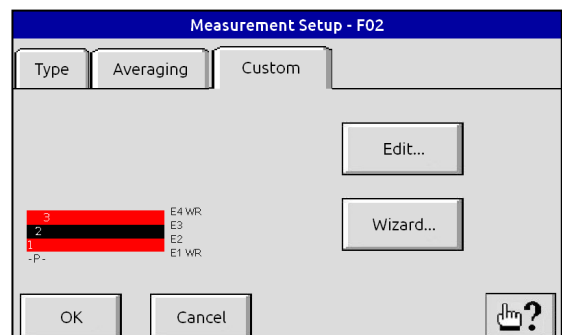

4.11.7 Nominal/Limits/Tolerance Setup

These two pages for **Nominal/Limits/Tolerances Setup** allow you to indicate acceptable deviation of the actual product from the desired product size. When these limits are exceeded, all the following are triggered: audible alarm, alarm digital output, and alarm indication on Main Measurement page.

NOTE: Upper or Lower Warning and Reject Limits can be selected to be displayed on the main measurement screen.

On the Tolerances tab, the Nominal is the desired product size. Limits will be computed from the nominal and tolerances.

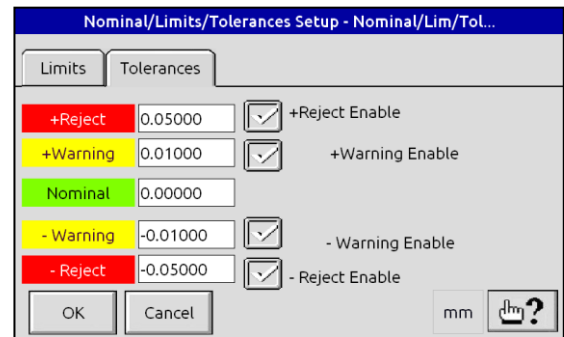
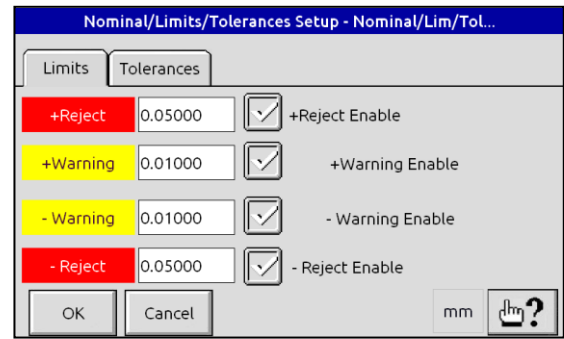

The Warning Tolerance value is the difference between the Nominal value and the Warning Limit, and the Reject Tolerance is the difference between the Nominal and Reject Limit. These relationships are written in equation form as:

$$\text{+Reject Tolerance} = (\text{+Reject Limit}) - \text{Nominal}$$

$$\text{+Warning Tolerance} = (\text{+Warning Limit}) - \text{Nominal}$$

$$\text{-Warning Tolerance} = \text{Nominal} - (\text{-Warning Limit})$$

$$\text{-Reject Tolerance} = \text{Nominal} - (\text{-Reject Limit})$$

4.11.8 Floating Nominal

The **Floating Nominal** function allows you to copy the current measurement of product size (displayed as Size on the screen) to the Nominal value. The Nominal is the desired product size and is used to compute values such as Deviation from the nominal size. When the nominal is updated, the limits are recalculated based upon the tolerance values defined in the Nom/Lim/Tol Setup.

NOTE: The Floating Nominal allows you to define a Nominal value based on the current product measurement. You can also define a Nominal value through the Measurement menu.

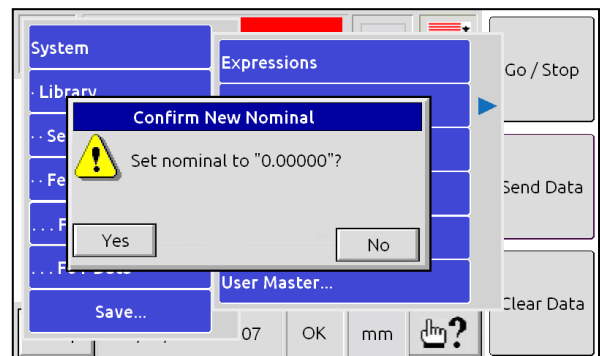

4.11.9 Master Measurement

The **Master Measurement** function allows you to ensure that your products match your pre-defined master size. This function creates a positive or negative offset to the size that equals the difference between the measured size and the size entered during mastering. This offset is applied to all measurements until cleared.

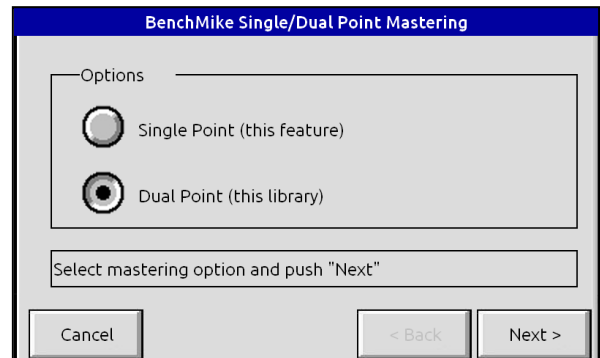

When you select **Single Point Mastering**, a setup wizard will walk you through the process of defining the numeric size of the master, placing it in the measurement area for measurement, and storing the value. Once completed, all future measurements will reference your master value.

When you select **Dual Point Mastering**, another setup wizard will walk you through the process of defining and measuring two master products. The larger master should be slightly larger than the largest product you expect to measure, and the smaller master should be slightly smaller than the smallest product you expect to measure. The masters should also have a difference in size of at least 20% of the BenchMike Pro's measurement range. For the 2025 there should be at least a 0.2 in. difference, and for the 2050, there should be at least a 0.4 in. difference. The BenchMike Pro's measurements will be linearly interpolated between those two master values.

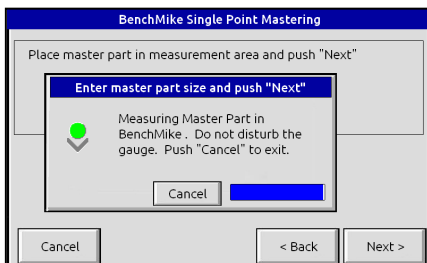
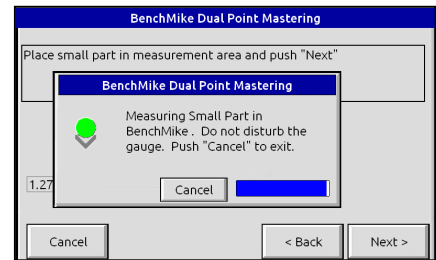
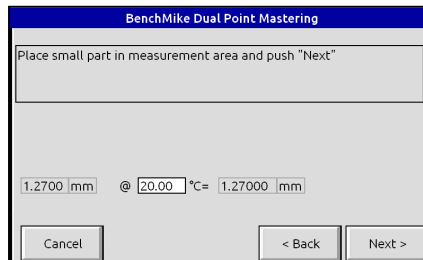
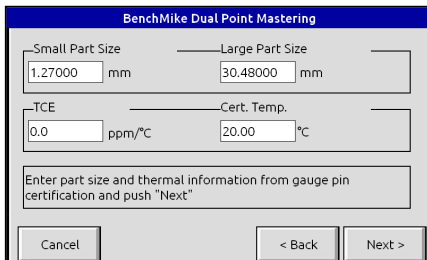

4.12 Data Functions

Select the **Data** option from the menu to specify a variety of options related to the display of measurement data.

If you have purchased a fixture, the words **Fixture Position** option will appear as shown. You can select Deviation, Nominal, Limits, and Tolerance values from this menu so that you can view them on the main page.

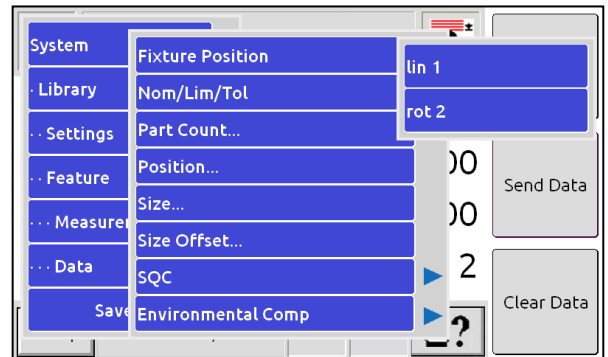
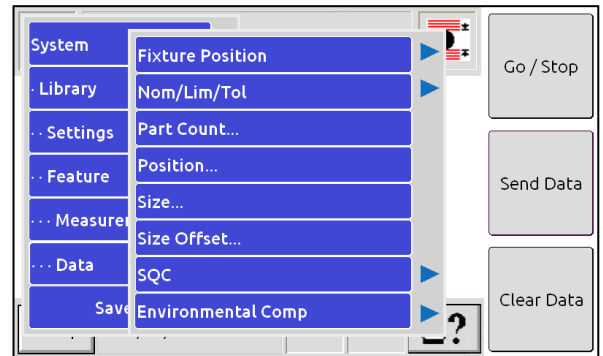

The **Deviation** of the measured product size from the desired (Nominal) value is an important value. Use this page to alter the title of this value to something meaningful and relevant to your application and to display or not display deviation. Deviation is calculated as:

$$\text{Deviation} = \text{Nominal} - \text{Size}$$

From the **Nominal** Setup page you can change the label for this value and determine where and whether it will be displayed on the main measurement display page. This value can also be transmitted via the serial #1 port or serial USB if desired. Serial output settings are defined under the System functions.

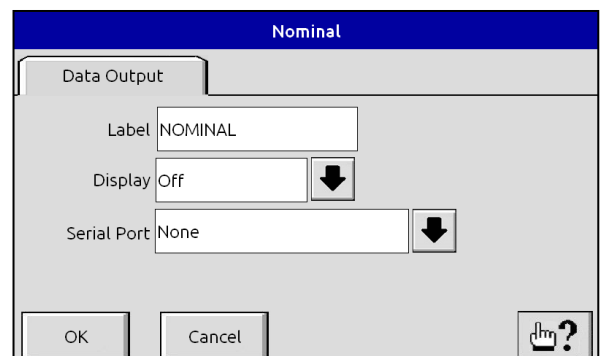
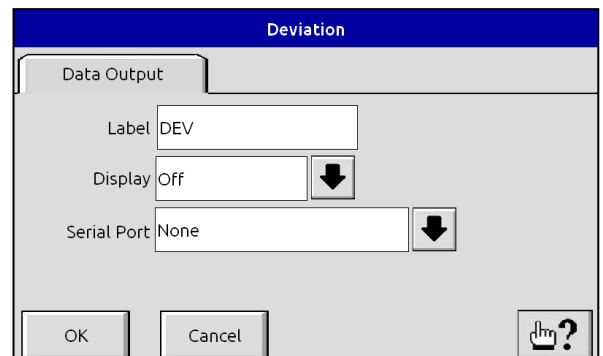

The **Limits** option allows you to specify which (if any) of the Warning and Reject Limits are displayed on the main measurement display page or are transmitted to the serial port. Positive and Negative and Reject and Warning Limits can be turned on and off individually.

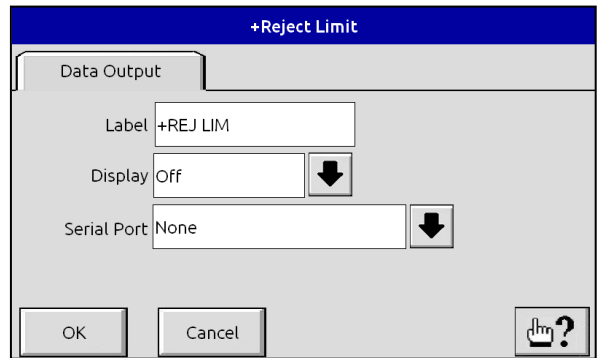

The **Tolerances** option allows you to specify which (if any) of the Warning and Reject Tolerances are displayed on the main measurement display page or are transmitted to the serial port. Positive and Negative Limits can be turned on and off individually.

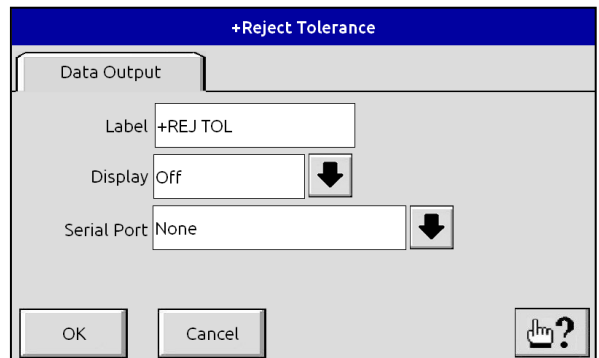

Note that individual pages are present for each item — +Reject Tolerance, +Warning Tolerance, -Warning Tolerance, and -Reject Tolerance — just as shown for the Warning and Reject Limits.

NOTE: With the Serial Output drop-down box, you can transmit this data value via the serial #1 port or serial USB. To set up the serial port for data transmission, see Settings - Serial Output Format and System- Serial for details.

The **Part Count** is used to display the number of parts that have been measured since data was last cleared.

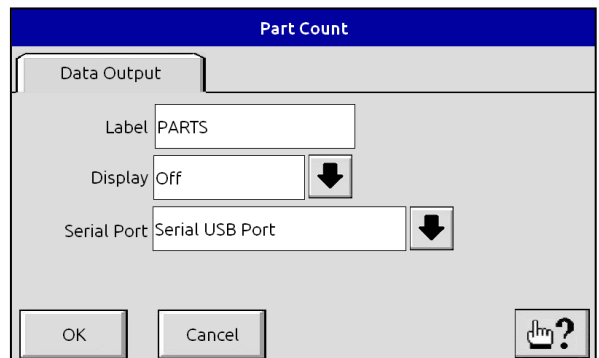

NOTE: If the Limits box is enabled (checked), limit checking is performed for Part Position or Part Size. By default, Part Size is limit-checked.

The **Part Position** displays the vertical part position. Part Position is the position of the part relative to the vertical center of the scan. A positive value indicates that the part is above the centerline, and a negative value indicates that the part is below the centerline. Use this page to alter the title of this value to something meaningful and relevant to your application, to display or not display the position on the main measurement display, and to transmit this value via the serial output port(s).

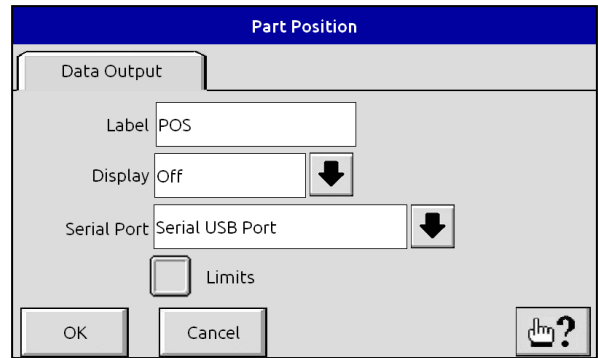

By default, the first line of data on the main measurement display contains the **Part Size** (diameter measurement). This label can be changed from SIZE to any other alphanumeric character string by touching the SIZE box on this screen. This measurement can be moved to another line or removed from the display. The Size value can also be transmitted via the Serial Output port.

NOTE: With the Serial Output drop-down box, you can transmit these data items via the serial or Ethernet port. To set up for data transmission, see Settings -Serial Output Format and System-Communication Ports for details.

Selecting the **SQC** command from the **Data** menu causes this menu to be displayed.

These SQC values are computed:

- **Average** is the average Size reading, as computed since the last time data was cleared.
- **Count** is number of readings that have currently been accumulated.
- **Maximum** is the largest Size reading detected since data was last cleared.
- **Minimum** is the smallest Size reading detected since data was last cleared.
- **Diff/TIR** is difference between the Maximum value and the Minimum value.
- **Standard Deviation** is the standard deviation of the mean from the Nominal.
- **Batch** is the group of readings used to compute the above SQC values.

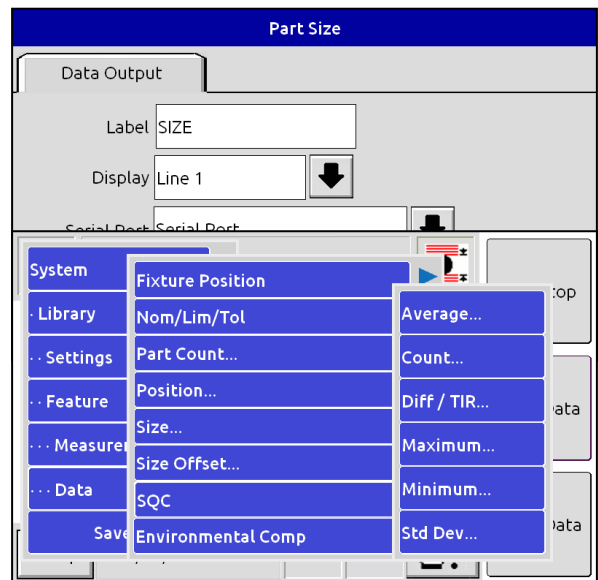

The **SQC Setup** menus for each of the SQC parameters are identical except for the title. Use these pages to change the label of the parameter or change its location on the main measurement page. You can also decide to transmit these values through the serial output. These parameters are: Average, Count, Diff/TIR, Maximum, Minimum, and Standard Deviation.

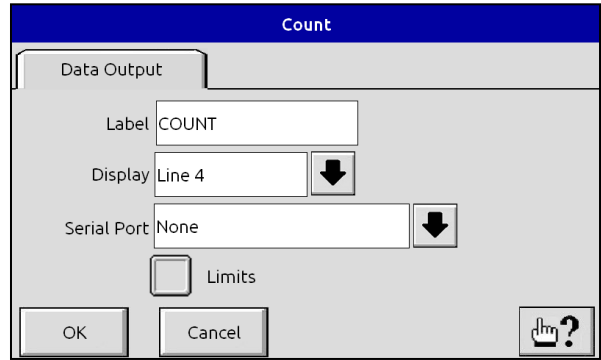

The **Optical Plate Temperature** displays the optical plate temperature as detected by the hardware.

The **Motherboard Temperature** displays the motherboard temperature as detected by the hardware.

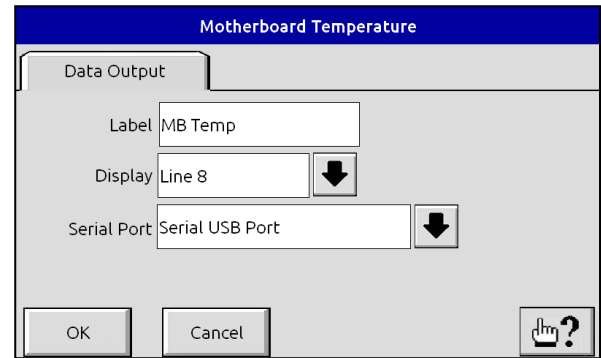

The **Actual Temperature** displays the part temperature as entered by the user. When Thermal Compensation is enabled, this value affects the measurement.

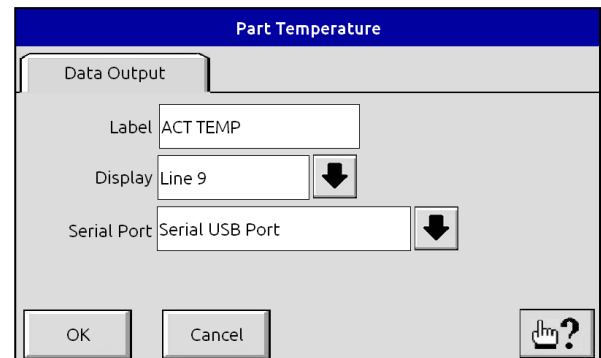

The **Actual Pressure** displays the pressure as read by the hardware. When Barometric Compensation is enabled, this value affects the measurement.

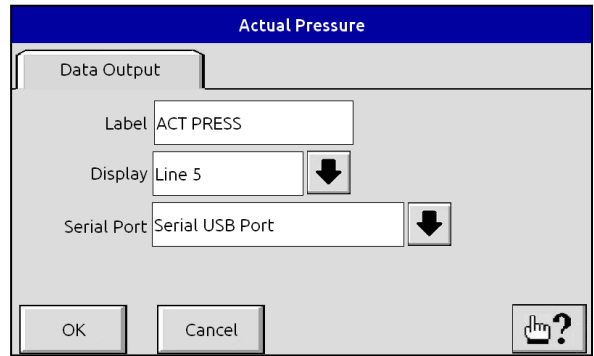

The **Barometric Temperature** displays the barometric temperature as read by the hardware. When Barometric Compensation is enabled, this value affects the measurement.

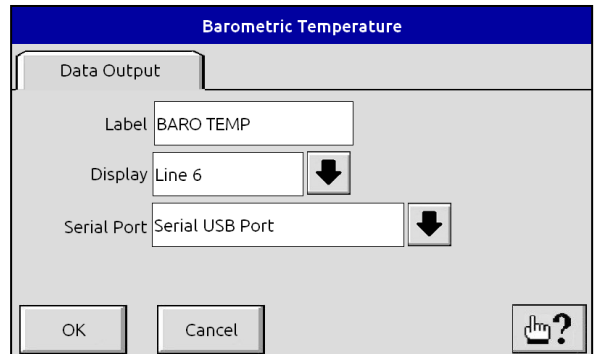

4.13 Save Function

You can save your changes to memory by selecting **Setup** → **Save** or **Setup** → **Library** → **Save**. You will be asked to confirm this decision to save all changes.

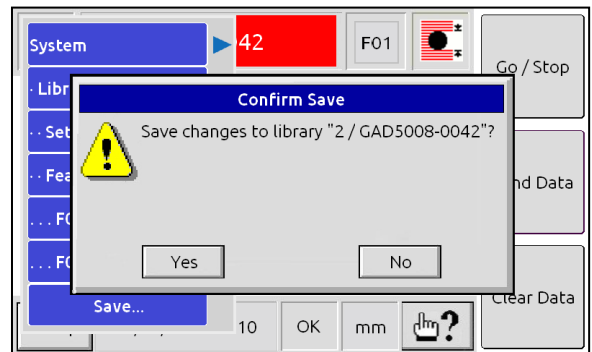

If you make changes to the setup of the BenchMike Pro but fail to save the data to memory, the title block on the top of the screen will have a red background and remain red until you have saved the settings.

If the BenchMike Pro is powered down in this state, all changes not saved will be lost.

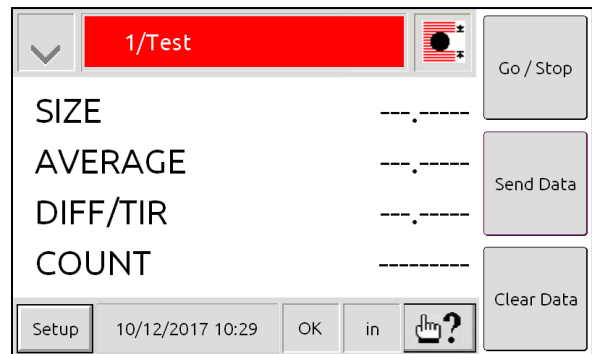

4.14 Status Menus

The Status block in the lower center of the main measurement display provides access to status information. This block will show **OK** if no errors are detected in BenchMike Pro operation, will show **ERR** (with a red background) if an error condition has been detected, and will show **!** if a condition exists that requires user intervention.

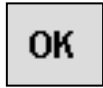

The Status menu displays messages for the gauge and for tolerance alarms. From this menu you can diagnose problems with the gauge, lock and unlock the BenchMike Pro (to protect your settings), and verify the current software version currently in use in your BenchMike Pro.

Note that PGS is the percentage of good scans. A number below 100% indicates a problem. The Rate value shown is the scan rate of the BenchMike Pro, in scans/second.

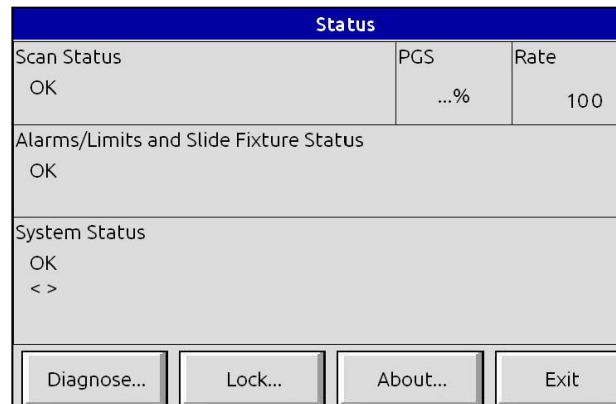

Possible status messages are given in the following tables.

Message	Description
Missing Edge(s)	Insufficient number of part edges in measurement area
Extra Edge(s)	Greater number of part edges in measurement area than expected
Low Power	Insufficient laser power for measurement
Overflow	Numerical overflow — numbers too large to handle
Scan Overrun	Data calculation cannot keep up with gauge's data rate
No Scan	No gauge start or stop pulse detected in 500 milliseconds.
Factory Calibration Required	Contact NDC Technologies Customer Service.

Message	Description
High Reject	Product size exceeds Positive Reject Limit value
Low Reject	Product size exceeds Negative Reject Limit value
High Warning	Product size exceeds Positive Warning Limit value
Low Warning	Product size exceeds Negative Warning Limit value
Slide Not Zeroed	Slide fixture has not been zeroed since power-up

The **Diagnose** page graphically shows the position of the product in the scanning laser beam. This page is used to verify that the product is positioned properly within the beam.

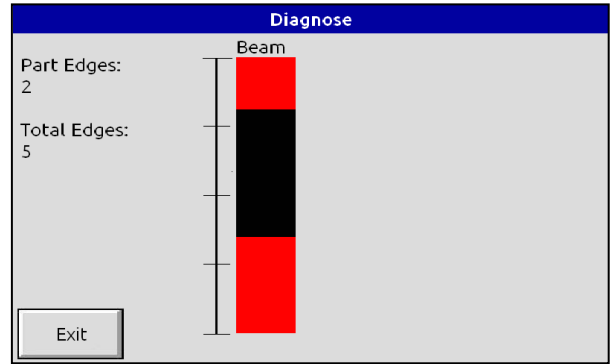

When you press the **Lock** button on the Status menu, you will be asked to confirm that you wish to lock the BenchMike Pro. Locking the BenchMike Pro secures all setup parameters so that they cannot be inadvertently changed.

Once the BenchMike Pro has been locked, you must enter the password to unlock the BenchMike Pro. Press the Unlock button from the Status menu, and enter the password. The factory-defined password is **000000**.

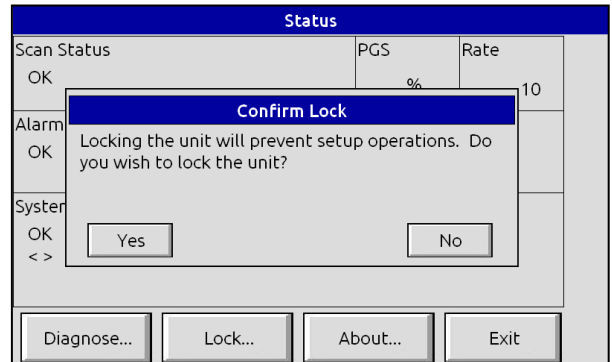

The **About** page allows you to view the current software revision for your BenchMike Pro. This information is helpful when speaking to Customer Service personnel about a problem.

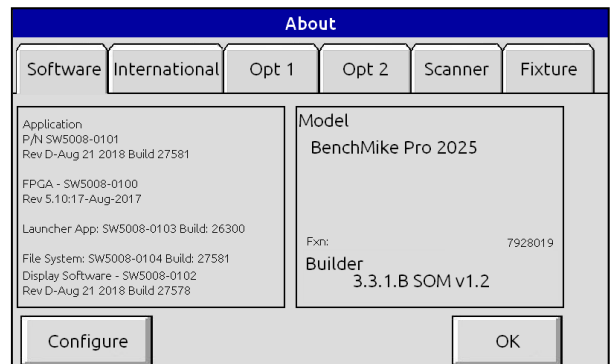

The **Configure** button allows you to control system parameters such as security, user interface settings, and scanner configuration. **Revision** information about a NDC Technologies Intelligent Fixture is also available from the Fixture tab, if an Intelligent Fixture is in use.

Note that tabs for international operation, installed options, scanner information, and fixture information are also displayed here.

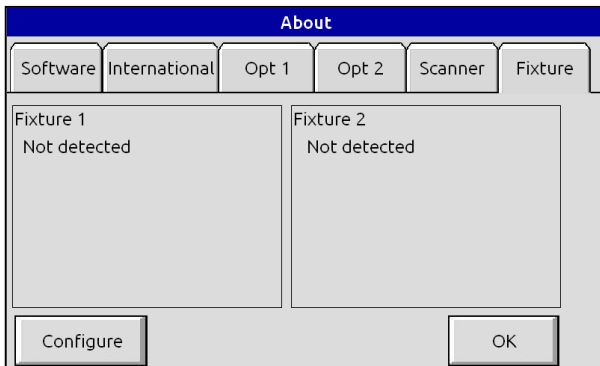
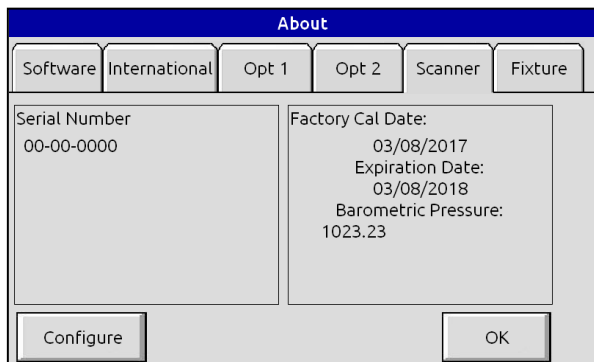
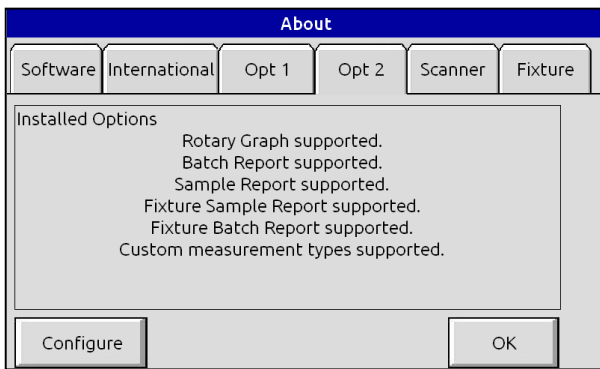
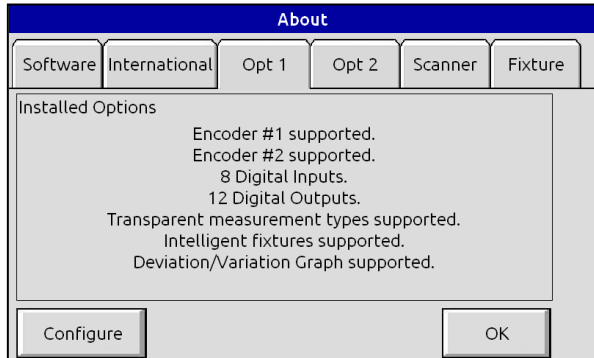
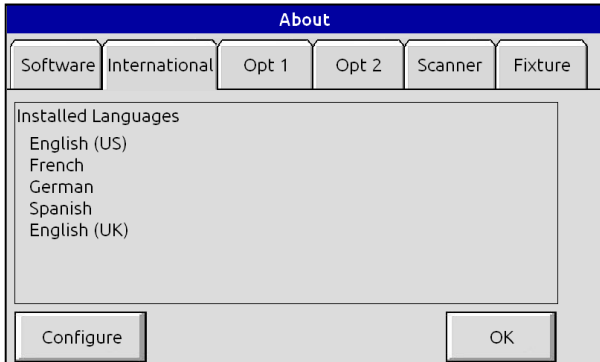

4.15 Security Setup

The BenchMike Pro Security features allow the unit set up to be password protected. The unit can be locked on power up. When the unit is locked, you have the option of permitting or preventing library, limit, nominal, or master information changes. You may also choose to set the unit to latch scan errors. In addition, the language used by the BenchMike Pro is programmed in the Security Setup. The Security parameters accessed and set as follows.

Access the security menu by pressing the **OK/ERR** button on the touch screen.

When the Status Screen appears, press the **About** button.

On the About Screen, press the **Configure** button.

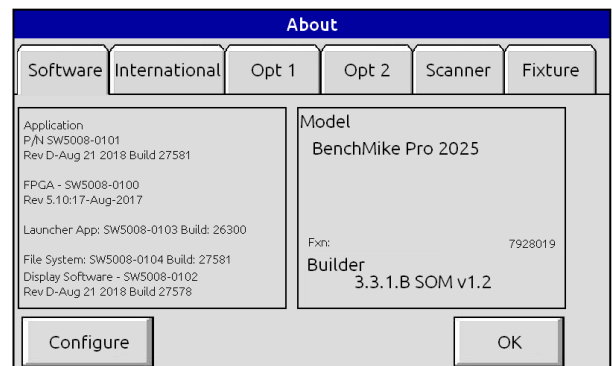

The following message screen appears.

Press yes to proceed; no to exit the Configuration menu.

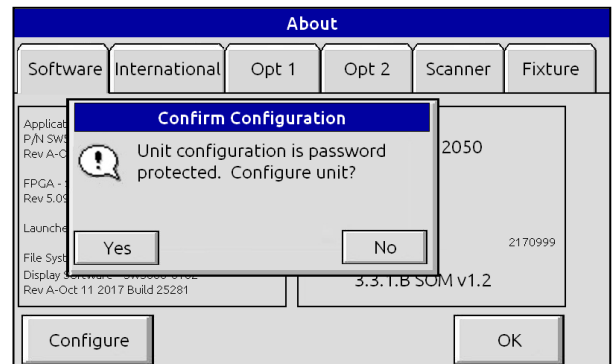

4.15.1 Entering the System Password

When you choose **Yes**, you will be asked to enter the password. The default password is **000000**.

NOTE: To toggle between upper case and lower case letters, press the Up arrow button.

4.15.2 Security Page

The Configuration screen will appear. To enter a new password or change an existing password, touch the current password in the Password block. The alphanumeric touch pad appears, and you will be prompted to enter new password. Touch the Password block and enter your password on the alphabetic touchpad.

Verify your password by re-entering when prompted.

Press OK to verify your new password.

The new password will appear in the password block.

Select options by touching the square next to the feature desired. A checkmark means that option is enabled. Note that when Power up locked is checked, the unit will be automatically locked on power up.

4.15.3 Lock Page

From this page, you can enable or disable three settings for locked operation.

When checked, **Allow nominal/limit/setup changes** will allow you to change nominal and limits settings when the unit is locked.

When checked, **Allow remastering** will allow you to change the master when the unit is locked.

When checked, **Allow library changes** will allow you to change libraries when the unit is locked.

All features chosen are activated when the OK button is pressed.

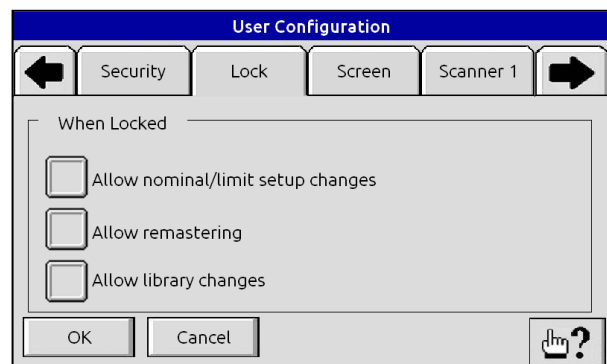
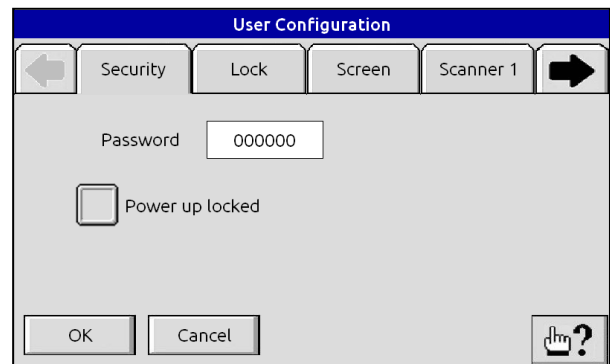
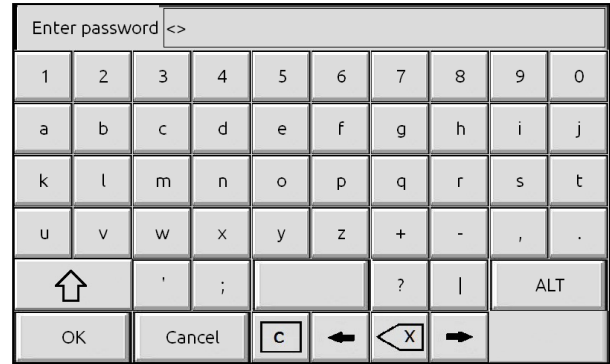

4.15.4 Screen Configuration

See the [Advanced Screen Capabilities](#) section for more information about these functions.

4.15.5 Scanner Configuration

From these three pages, you can send and receive information about the configuration of the BenchMike Pro's scanner settings. This information is typically only used by NDC Technologies Service personnel. The data can be sent or received via the serial ports. The data is in ASCII format and can be saved on a PC. The **Local file** option will save the scanner setting data to a file on the unit that is independent of the library file. Saving the file to **USB file** will write the data to a user-provided USB Flash memory device inserted into the rear USB-A port. The file will be written to the root folder under the **NDC_BenchMike** folder. The name will be composed of the serial number of the unit, followed by **.lintable**. For example, with a serial number of 34-19-3042, the file-name would be `\NDC_BenchMike\34-19-3042.lintable`.

DO NOT use the Receive New function to transfer Scanner Configuration settings from one BenchMike Pro to another without contacting Customer Service first. Improper use of this function may cause your BenchMike Pro to operate improperly.

From the Scanner 2 page, you can enable or disable three settings of the scanner: Focused + Double Differentiation, Use Linear Table, and Use Barometric Compensation. Note that you should not change the double differentiation function. The gauge will not function properly if altered.

The calibration reminder information on Scanner 3 page can be used to set the reminder to match your standard calibration schedule. The expiration date is displayed on the About-Scanner page.

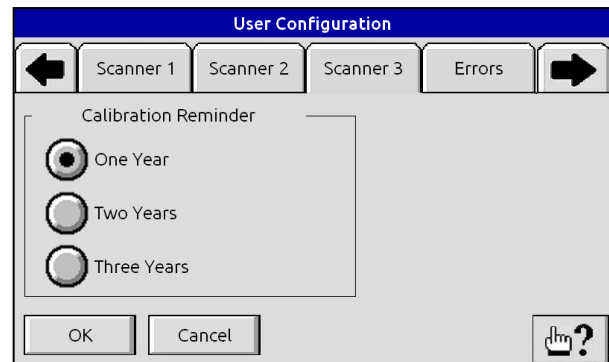
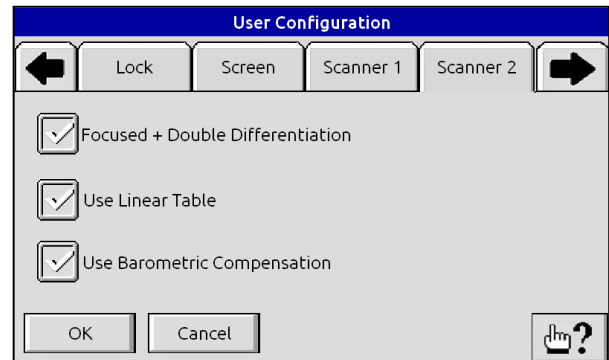
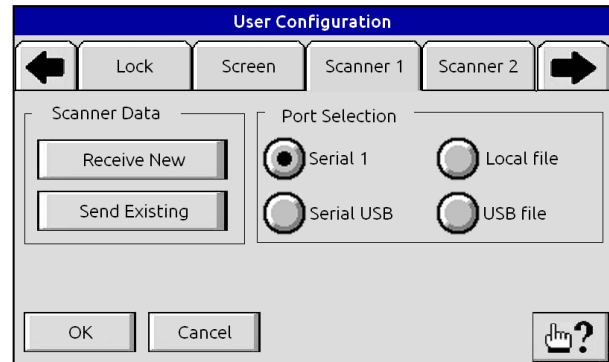
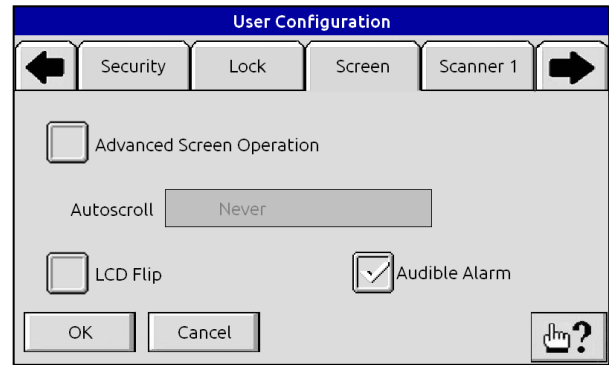

4.15.6 Scan Errors Configuration

This page allows you to determine whether scanner errors are latched or not. When enabled, all scan error conditions will persist until cleared by the user.

Selecting Ignore Scan Errors disables scan error detection. This can result in erroneous measurements. Use this feature with caution.

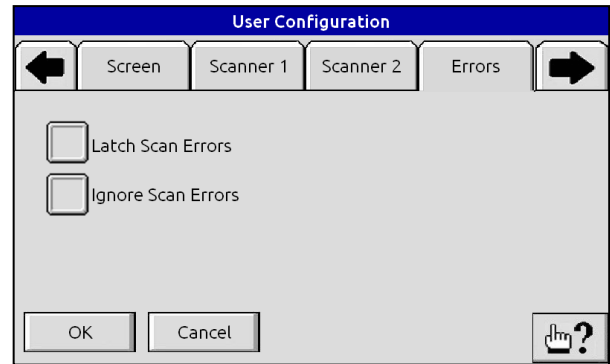

4.15.7 International Configuration

From this page you can select UK English, US English, French, German, or Spanish for all spelling, date, and number formats. Other international language support is available. Contact NDC Technologies for details.

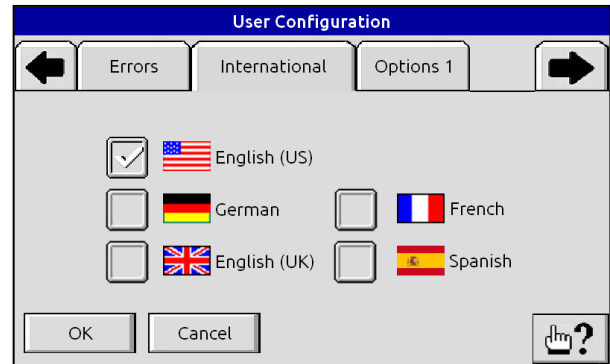

4.15.8 Options 1: Reports

This page allows you to enable or disable report options. Note that Fixture Reports will only provide data during measurement when a fixture is connected or configured for use.

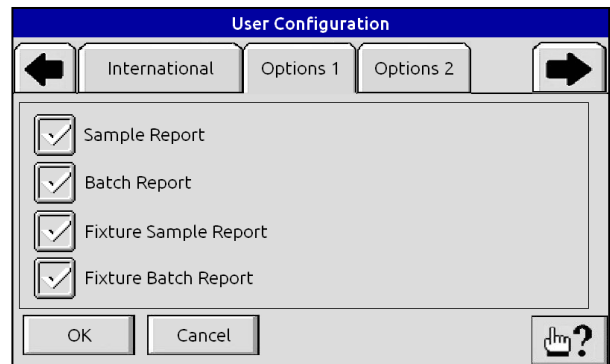

4.15.9 Options 2: Graphs

This page allows you to enable or disable two graph options. Note that these graph pages will only operate during measurement when a rotating fixture is connected or configured for use. When setup is complete, press the **OK** button to accept changes. At the Revision Screen, press **Exit** to return to the main screen.

Use unit as ID OD WALL system

Select this option to enable the IDODWall option for the unit. When the first fixture is an IDODWall type of fixture and this option is selected, the system will setup features and other settings to provide the ID, OD, and Wall measurement feature. Note that when this option is changed, the **Setup-Save** button must be selected to save this change and the unit must be power cycled. When the unit powers back up, the IDODWall option will be enabled. Initialize the library to complete the IDODWall activation.

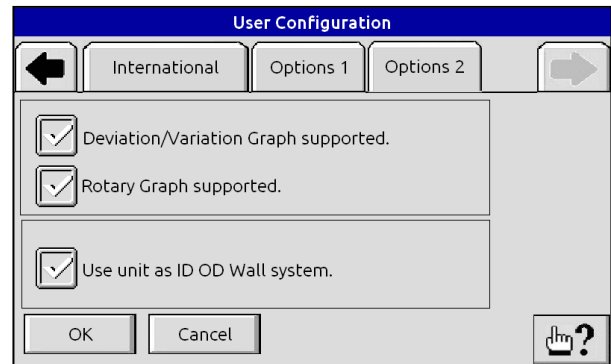

5 | Advanced Capabilities

5.1 Expression Editor

The Expression Editor allows you to compute values based on data collected by the BenchMike Pro. Each expression you define is linked to the Feature in which it is created.

As shown on the screen to the right, you can copy, cut, edit, delete, insert, paste, move, and restore the expression from factory defaults.

To access this page, select the Setup icon, then Measurement, and then Expression.



Expressions are evaluated when the Feature containing the expression is placed in Go mode.

Here are two examples of valid expressions:

f1.size = seg[2] + f1.size.offset

f1.pos = (seg[1] - seg[3]) / 2.0

5.1.1 Components of the Expressions

5.1.1.1 Operators

Operators are evaluated in order of precedence. Multiplication and division have higher precedence than addition and subtraction and are therefore evaluated first. Where operators have equal precedence, the expression is evaluated from left to right.

Precedence	Operator	Description
8 (highest)	(or)	Parenthetical expression
7	+ or -	Unary plus and minus (for example, -4)
6	* or /	Multiplication and division
5	+ or -	Addition and subtraction
4	< or ≤ or > or ≥	Less-than, less-than-equal, greater-than, and greater-than-equal
3	= or ≠	Equal and not-equal
2	=	Assignment
1	,	Separator (used to separate function assignments)

For example,

$4 + 2 * 9 = (2 \text{ multiplied by } 9) \text{ and then add } 4$

$28 / 3 * 9 = (28 \text{ divided by } 3) \text{ which is then multiplied by } 9$

5.1.1.2 Constants

All constants are considered floating point values, even if entered without a decimal point. Constants may be used anywhere within an expression, and are stored in double floating point precision.

For example,

`f1.size = seg[2] + 0.0005`

`tsize = f1.size + ((f2.size*0.349) - 0.000032)`

5.1.1.3 Variables

Variable names are composed of letters and numbers. The first character must be a letter. The following characters may also be used in a variable name:

`_` (underscore) and `.` (period). Note that upper and lower case characters are separate characters. For example, "x" is not equal to "X". Variable names are limited to 31 characters in length. Note also that a space is not a valid variable character.

Here are some example variable names:

seg[2]

f1.pos

f2.circumference

Once defined, a variable name can be utilized in any feature, from #1 to #32.

Variables are created by assignment, such as the expression a=2. The value assigned to variable “a” is updated if another expression changes its value.

5.1.1.4 Reserved Variable Names

Each feature contains a list of reserved variables, as listed in the following table. These variable names follow the format:

fn.xxx

where n is the feature number and xxx is the reserved variable name.

For example, the size variable for feature #1 is f1.size, and the deviation variable for feature #20 is f20.dev.

Variable	Description
average	SQC average
count	SQC count
dev	Deviation from nominal
diff	SQC difference (maximum – minimum)
good	Count of “good” measurements (limits)
lrlim	Lower reject limit (-reject)
lrtol	Lower reject tolerance (-reject)
lwlim	Lower warning limit (-warning)
lwtol	Lower warning tolerance (-warning)
max	SQC maximum
min	SQC minimum
nominal	Nominal size
over	Count of “over” measurements (limits)
pos	Position in measurement area

pos.offset	Position in measurement area "offset"
sd	SQC standard deviation
size	Measured size
size.offset	Measured size "offset" (single point master)
under	Count of "under" measurements (limits)
urlim	Upper reject limit (+reject)
urtol	Upper reject tolerance (+reject)
uwlim	Upper warning limit (+warning)
uwtol	Upper warning tolerance (+warning)

You can use also access individual segments, fixture position, temperature information, and global variables (see following table).

Usage	Description
seg[x]	Returns the size of segment x, where x is a valid segment number. See Measuring a Product for a description of segments.
linposx	Returns the current position of linear fixture #1 or #2, where x is the fixture number. This name is used only with an Intelligent Linear Fixture, and is not tied to a Feature.
rotposx	Returns the current position of rotating fixture #1 or #2, where x is the fixture number. This name is used only with an Intelligent Rotational Fixture, and is not tied to a Feature.
globx	Returns the value of a global parameter, where x is 1, 2, 3, or 4.
temp	Returns the Thermal Compensation Actual Temperature.
size.tmult	Returns the value of the Thermal Compensation Multiplier

Global variables are reserved for the end user. The BenchMike Pro will not modify their values. They are used system-wide and are non-volatile. This means that, once defined, each value remains fixed across libraries, features, and even after power down. You may set their value as an expression or via a PURL command.

5.1.1.5 Mathematical Functions

You can also use the following mathematical functions in your expressions. These expressions use double floating point precision.

Function	Usage	Description
abs	abs(num)	Absolute value of num
acos	acos(num)	Arccosine of num; returned angle is given in radians from 0 to pi.
asin	asin(num)	Arcsine of num; returned angle is given in radians from $-\pi/2$ to $+\pi/2$
atan	atan(num)	Arctangent of num; returned angle is given in radians from 0 to pi.
atan2	atan2(xnum,ynum)	Arctangent of the specified x and y coordinates; the arctangent is the angle from the x-axis to a line containing the points (0,0) and (xnum,ynum); returned angle is given in radians from $-\pi$ to $+\pi$.
baroPress	baroPress	Returns the Barometric current pressure value.
ceil	ceil(num)	Ceiling; returns smallest integer not less than num.
cos	cos(num)	Cosine of num; num is given in radians.
degrees	degrees(angle)	Converts an angle in radians to degrees.
cosh	cosh(num)	Hyperbolic cosine of num.
exp	exp(num)	Natural logarithm power; e^{num}
floor	floor(num)	Floor; returns largest integer not greater than num.
log	log(num)	Natural logarithm (base e) of num.
log10	log10(num)	Base-10 logarithm of num.
max	max(num1,num2)	Maximum of num1 and num2.
min	min(num1,num2)	Minimum of num1 and num2.
pi	pi()	Mathematical constant pi.

pow	pow(num,pow)	Raises num to the power “pow”
radians	radians(angle)	Converts degrees to radians.
sin	sin(num)	Sine of given angle; num is in radians
sinh	sinh(num)	Hyperbolic sine of given angle, num.
sqrt	sqrt(num)	Square root of num
tan	tan(num)	Tangent of given angle; num is in radians
tanh	tanh(num)	Hyperbolic tangent of given angle, num.

5.2 Advanced Screen Capabilities

The BenchMike Pro also has advanced screen capabilities. These capabilities allow you to display up to 32 data items in the data display area of the screen. When more than four data items are selected for display, a scroll bar appears on the right of the screen so that you can move through the selected items.

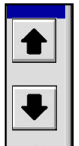

When tolerance checking has been enabled for a displayed data item, the data item will be automatically scrolled into view if the condition(s) defined by Display Scrolling are detected. These conditions are: Warning Tolerance only, Reject Tolerance only, Warning or Reject Tolerance, and Never.

5.2.1 Accessing Advanced Capabilities

Follow these steps to access these advanced capabilities.

1. Touch the **Status** icon (shows OK, Err, or !) from the main screen.
2. Touch the **About** button.
3. Touch the **Configure** button.
4. Enter the password. The default password is **000000**.
5. Select the **Screen** tab. Make sure the **Advanced Screen Operation** box is checked to enable these capabilities. Click OK.

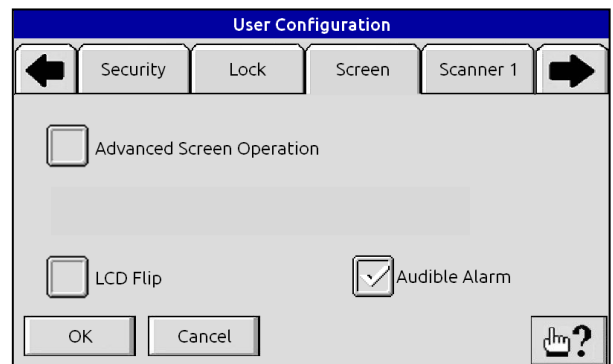

- From the main data display, touch any data item in the center of the screen. A new menu will appear as shown.

The **Magnify** function magnifies a single line of data to be visible from a distance.

The **Delete** function deletes the line of data that was touched, and the line below it is moved up one line.

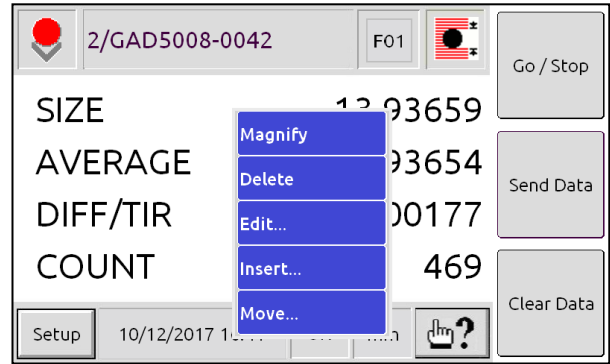

The **Edit** function brings up the Display Data Edit page and is used to edit an existing line of data. The three properties associated with this data item can be changed as follows.

Type can be set to Data or Variable.

Source can be set to any Feature number, from 1 to 32.

Item can be set to: Average, Count, Deviation, Difference/TIR, Lower Reject Limit, Lower Reject Tolerance, Lower Warning Limit, Lower Warning Tolerance, Maximum, Minimum, Nominal, Position, Position Offset, Size, Size Offset, Standard Deviation, Upper Reject Limit, Upper Reject Tolerance, Upper Warning Limit, Upper Warning Tolerance.

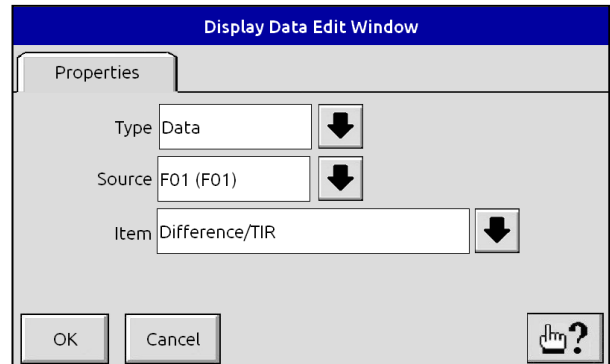

The **Insert** function brings up the Display Data Edit page and is used to insert a line of data before or after the selected line.

The **Move** function rearranges the order of the lines on the main data page. You can move the selected data line Up One line, Down One line, to the Top, or to the Bottom.

If any of the items selected for display are from a different Feature, they will be identified by the Feature number to the right of the data label.

If you wish to change or disable these screen functions, repeat these steps as required.

5.2.2 Tolerance and Limit Checking Display Capabilities

If tolerance or limit checking is defined for a data item and that item is not on the screen when an alarm occurs, that item will automatically be scrolled into view.

5.3 Custom Measurements

The BenchMike Pro has eighteen measurement types, as shown. When you wish to measure or calculate a dimension other than the first seventeen in this list, you can use the Custom Measurement Type to define your own.

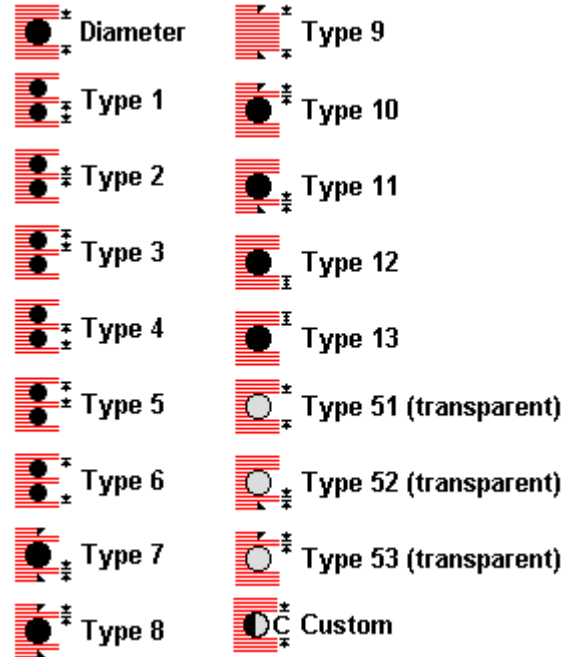

To access the Custom Measurement Wizard, select **Setup**, then **Measure**, then **Measurement**, and then select the **Custom** tab. The screen shown will appear.

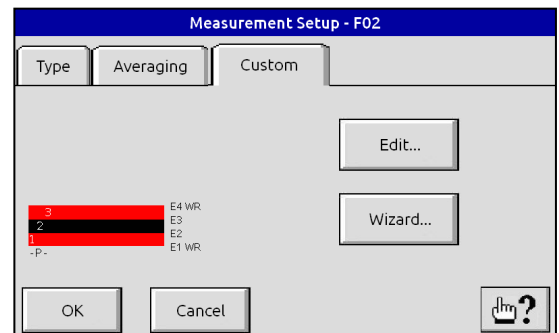

You can access the page shown by selecting the **Edit** button instead of **Wizard** from the Custom Measurement Setup screen. Note that all segments corresponding to your selections on the previous pages will be identified. Select the desired segment(s), and use the Properties button if necessary, to customize this measurement.

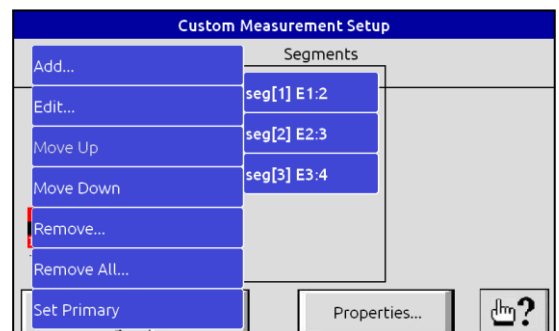
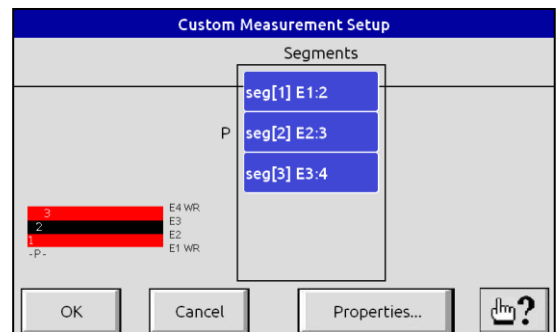

If you select the Custom **Wizard**, several pages will be displayed, each allowing you to select settings for your measurement. Part Wizard can be used with products of less than 58 segments. See also [Measuring a Product](#).

If you wish to create a custom measurement using a sample part, select **Measure Part Sample**. The Wizard will step you through the process of selecting the desired segments based on a sample which you place in the measurement area of your BenchMike Pro.

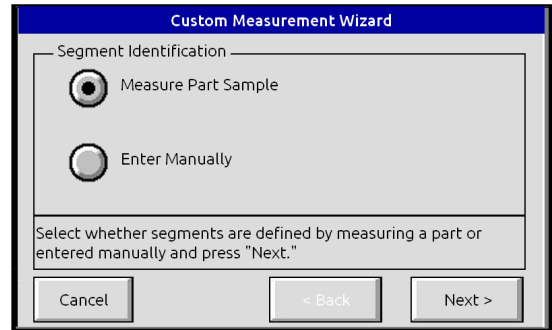

If you wish to enter the definition of your Custom measurement **manually**, these screens will appear.

With a Custom measurement, you can direct the BenchMike Pro to measure and display either the dark segments (regions where laser light did not reach the BenchMike Pro's receiver), light segments (regions where laser light did reach the receiver) or both.

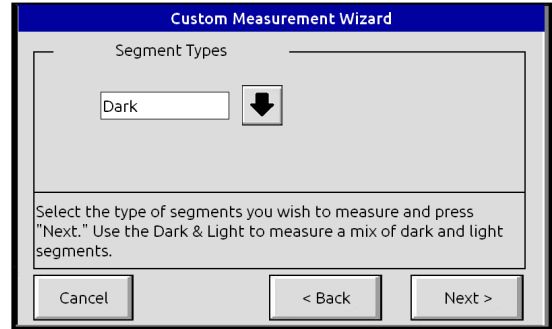

If your product is transparent, you can change the BenchMike Pro's logic to ensure that light bleeding through the product does not adversely affect measurements. If your product is not transparent, it is recommended that you select the Non-Transparent option.

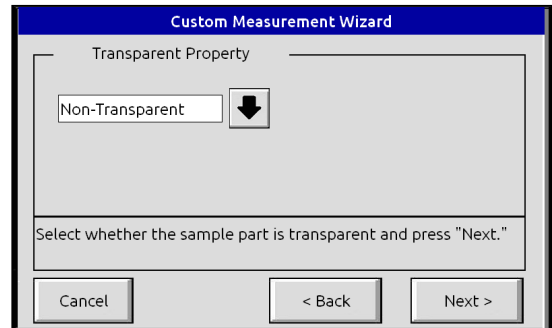

With this page, you can allow the BenchMike to identify the number of segments in the measurement area.

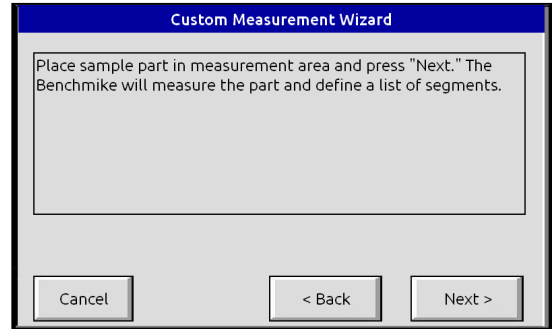

Only one Custom measurement per Feature can be defined at a time.

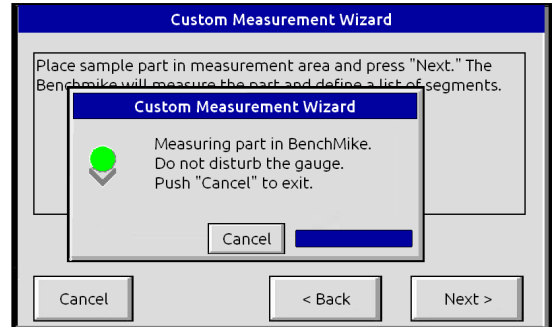

5.3.1 Custom Measurement Properties

This screen allows you to manually set up the measurement type. Select the Reference Edges selection to match your physical setup.

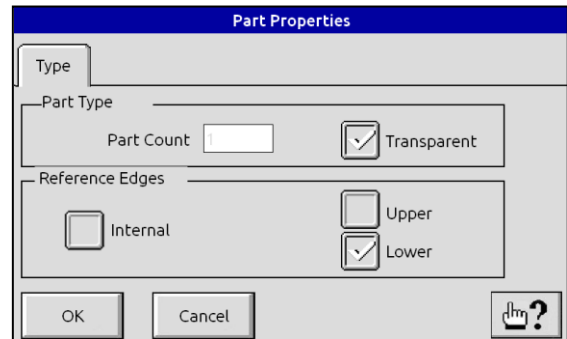

5.4 Using a Footswitch

A footswitch can be used to trigger a BenchMike Pro function without touching the BenchMike Pro itself. Connect the DB-25 connector of the footswitch to the DB-25 plug on the rear of the BenchMike Pro labelled DIGITAL I/O. The footswitch should be connected between pin 2 and pin 12 on this connector. All pins are defined in the [Digital I/O Connector](#) section.

6 Remote Setup

6.1 What is PURL?

The Programmable Universal Resource Language (PURL) is a command language used by some NDC Technologies products. The BenchMike Pro utilizes PURL to communicate with a host computer via the serial port.

You can write your own software programs with PURL to perform necessary functions, or you can utilize a NDC Technologies program, such as LibraryPro. Note the symbols listed below. These symbols are used in this manual to indicate non-printable characters.

6.1.1 Non-Printable Characters

Symbol	Description	Abbreviation	HEX	Key
☺	Start of Header	SOH	01	Ctrl-A
☺	Start of Text	SOT	02	Ctrl-B
◆	End of Transmission	EOT	04	Ctrl-D
♠	Acknowledgement	ACK	06	Ctrl-F
⓪	Line Feed	LF	0A	Ctrl-J
♪	Carriage Return	CR	0D	Ctrl-M
§	Negative Acknowledge	NAK	15	Ctrl-U
L	Field Separator	FS	1C	Ctrl-\

6.2 Command Format

Each command is composed of several phrases, plus a wrapper, forming a statement which looks like the one below, where the number of phrases varies based on the entire command.

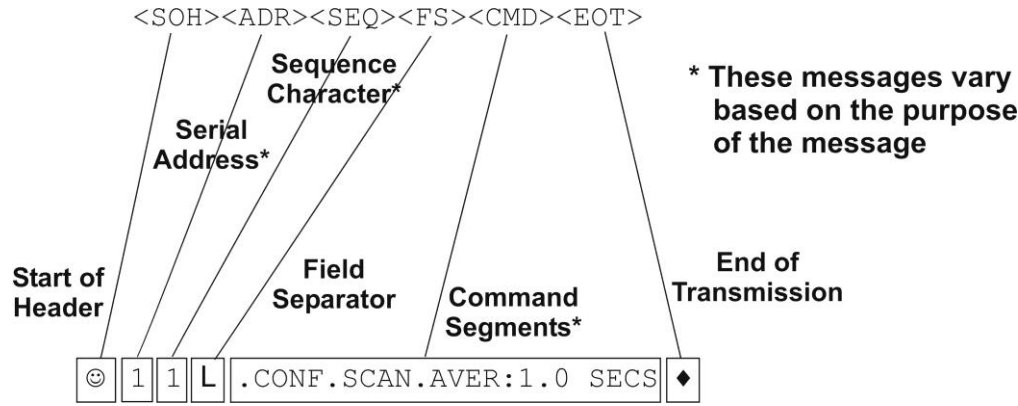

The BenchMike Pro also allows a simplified structure without the wrapper, following the format below.

```
CMDA.CMDB.CMDC.CMDD:DATA ␣
```

The BenchMike Pro responds to commands in a format that matches the command. If a command has a wrapper, then so will the response.

6.2.1 Messages to the BenchMike Pro Without the Wrapper

When you are requesting information from the BenchMike Pro, the command concludes with a question mark. For example, to learn what baud rate is defined for the serial port, you would use the following command:

```
CONF.SER.BAUD? ␣
```

When you are issuing a command to the BenchMike Pro, the command includes a colon to separate it from the desired value. For example, to specify a baud rate of 19200, you would use:

```
CONF.SER.BAUD:19200 ␣
```

If you omit the ? or the : from your command, then ? is assumed.

6.2.2 Messages from the BenchMike Pro without the Wrapper

Here is the format of a message from the BenchMike Pro to the host device, with a sample message, **when the message has been understood and data is returned:**

```
500♣♠
```

Here is the format of a message from the BenchMike Pro to the host device, with a sample message, **when the message has been understood but there is no data to return:**

```
♣♠
```

Here is the format of a message from the BenchMike Pro to the host device, with a sample message, **when the message was invalid or is not understood:**

```
BAD COMMAND♠
```

When the BenchMike Pro receives a command that is not understood or is invalid, it will return a text string indicating the reason for the lack of acknowledgement in addition to the NAK response. These text strings vary to indicate the type of error.

6.2.3 Messages to the BenchMike Pro with the Wrapper

When sending a message from the host device to the BenchMike Pro with the wrapper, the example given on the previous page is used. The following are descriptions of the segments of that command.

Start of Header <SOH>☺

The Start of Header is a non-printable character that begins all PURL commands.

Serial Address <ADR>

The Serial Address command is currently not supported. The BenchMike Pro will respond to any address.

Sequence Character <SEQ>

The Sequence Character is a single, printable ASCII character selected by the user. This allows you to match commands to BenchMike Pro responses, which is important when you have issued several commands. Since these values are user-selected, remember to keep track of them as they are used. If you are writing a program to communicate with the BenchMike Pro, you should increment this number each time you send a command. When the BenchMike Pro responds, verify that the Sequence Number of the response equals the Sequence Number of the command that you sent.

Field Separator <FS> L

The Field Separator is a non-printable character that indicates the start of the Command Segment, or the Returned Data.

Command Segment <CMD>

Each Command is composed of several message parts, separated by periods. The number of characters varies based on the command itself. When you are asking the BenchMike Pro to return information to you, the command ends with a question mark.

End of Transmission <EOT> ♦

The End of Transmission is a non-printable character that indicates the end of the Command Segment, or the Returned Data.

6.2.4 Messages from the BenchMike Pro with the Wrapper

Here is the format of a message from the BenchMike Pro to the host device, with a sample message, when the message has been understood and data is returned:

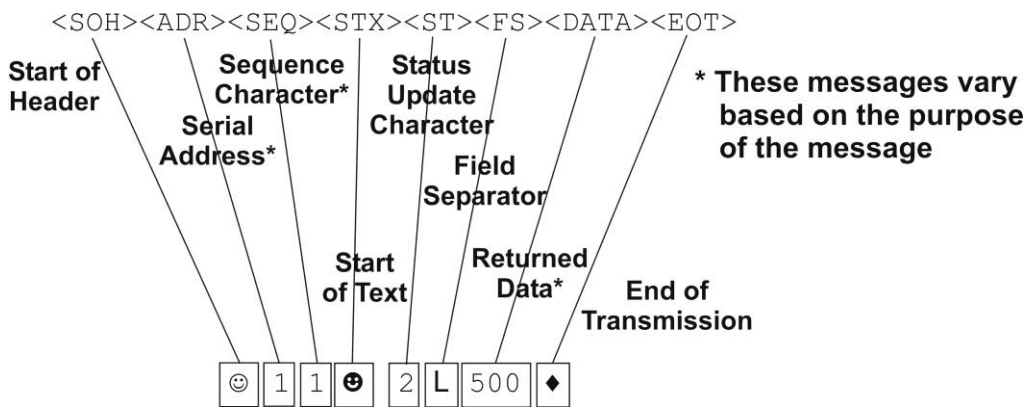

Start of Text <SOT>☉

The Start of Text Character is a non-printable character that precedes the Status Update Character.

Status Update Character <ST>

The Status Update Character is a single ASCII character which indicates a status change. The status conditions are grouped into four categories: System, Scanner, Flaw, and Tolerance. The Status Update Character indicates which of these groups have changed. If you know that the status has changed, you can then request the latched status condition from the BenchMike Pro. The following table lists the Status Update Characters in ASCII and binary formats.

6.2.4.1 Status Update Characters

Status Update Character		Status Change			
ASCII	Binary	Tolerance	Flaw	Scanner	System
0	0011 0000				
1	0011 0001				YES
2	0011 0010			YES	
3	0011 0011			YES	YES
4	0011 0100		YES		
5	0011 0101		YES		YES
6	0011 0110		YES	YES	
7	0011 0111		YES	YES	YES
8	0011 1000	YES			
9	0011 1001	YES			YES
:	0011 1010	YES		YES	
;	0011 1011	YES		YES	YES
<	0011 1100	YES	YES		
=	0011 1101	YES	YES		YES
>	0011 1110	YES	YES	YES	
?	0011 1111	YES	YES	YES	YES

The lower four bits of the Status Update Characters in binary format correspond to the four groups listed above. The following table shows the PURL commands associated with these conditions.

6.2.4.2 Status Update Characters and Commands

Status Update Character	Type of Status Change	Command to Request the Latched Status*	Command to Request the Non-Latched Status**
Bit 0	System	.SYST.STAT.ALARMS?	.SYST.STAT.NOW.ALARMS?
Bit 1	Scanner	.SYST.STAT.SCAN?	.SYST.STAT.NOW.SCAN?
Bit 2	Flaw	.FLAW.STAT?	.SYST.STAT.NOW.FLAW?
Bit 3	Tolerance	.SYST.STAT.TOL?	.SYST.STAT.NOW.TOL?

Return Data <DATA>

The Returned Data varies based on the command issued. This segment of the response contains the requested numeric value, such as the laser gauge's scan rate or the baud rate of the selected port.

Here is the format of a message from the BenchMike Pro to the host device, with a sample message, **when the message has been understood but there is no data to return:**

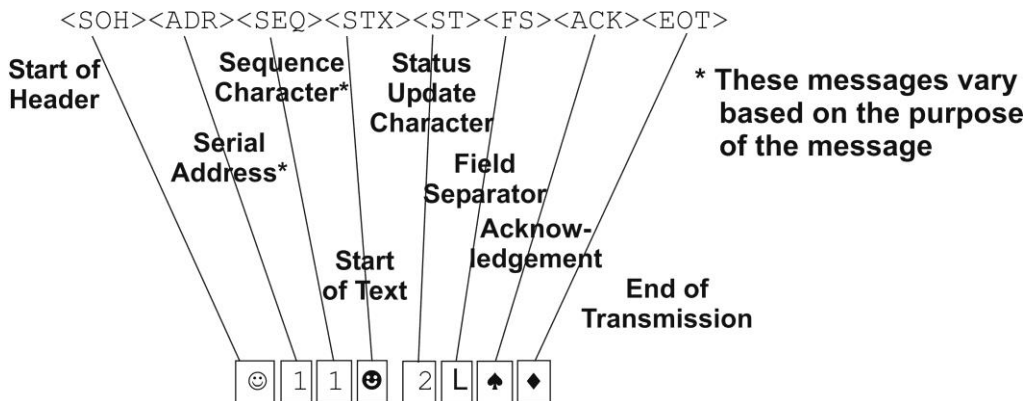

Acknowledgement <ACK> ♠

The Acknowledgement indicates the receipt of a good command. When the Acknowledgement is returned by the BenchMike Pro, the command has been properly received and consider valid.

Here is the format of a message from the BenchMike Pro to the host device, with a sample message, **when the message was invalid or is not understood:**

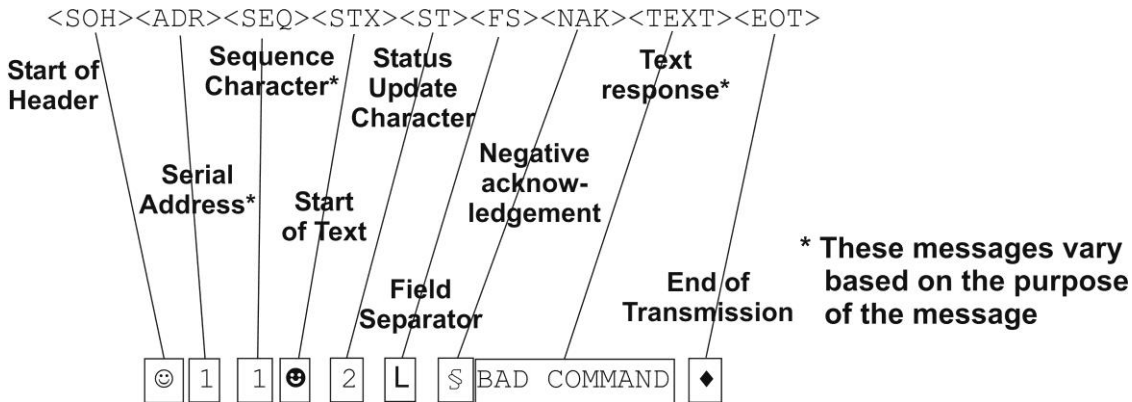

Negative Acknowledgement <NAK> §

When the BenchMike Pro receives a command that is not understood or is invalid, it will return the NAK response, in addition to a text string indicating the reason for the lack of acknowledgement. These text strings vary to indicate the error in the user’s command.

The following table lists possible text responses indicating the source of a failed command.

Returned Message List
SERIAL OVERRUN
PARITY ERROR
FRAMING ERROR
BAD COMMAND
UNIT MUST BE STOPPED
UNIT MUST BE STARTED
TIMEOUT-NOT ENOUGH SCANS
CALIBRATION REQUIRED
SCALE TOO SMALL
1ST PIN CALIBRATED
NO AXES
NO WAVEFORM
LOOPBACK FAILURE
SCANNING MUST BE HALTED
UNABLE TO WRITE VALUE
UNABLE TO READ VALUE

EQUATION TOO LONG
BAD EQUATION
BAD SEGMENT
DIVIDE BY ZERO
TOO MANY SEGMENTS
STRING TOO LONG
BAD FORMAT
INVALID SELECTION
NO GOOD MEASUREMENT
NO I/O CARD PRESENT
COMMAND FAILED
DUPLICATE DH+ NODE
UNIT MUST BE OFFLINE
DISABLED BY DIP SWITCHES
DATA LIST TOO LONG
FEATURE NOT ENABLED
BAD VALUE

Here is the format of a message from the BenchMike Pro to the host device, with a sample message, when the message is not a response to a host request. This message is sent when the BenchMike Pro is configured to transmit measurements as soon as they are available (i.e., .MEAS.POLLED:NO).

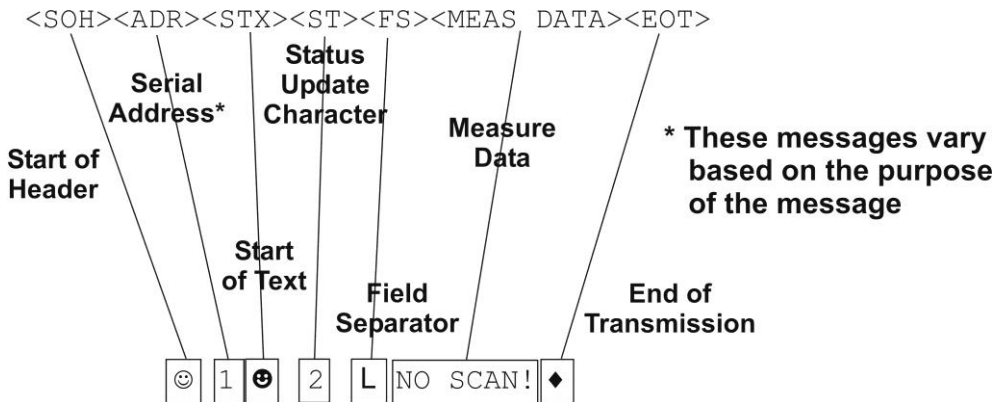

Measure Data <MEAS DATA>

Measure Data is either the actual measurement data specified by the .MEAS.FORMAT command or is an error message. The error messages are:

NO SCAN! ␣

GATE OBSCURED! ␣

MISSING! ␣

EXTRA! ␣

EXCESSIVE FILTERING! ␣

100% FLAWS! ␣

LOW POWER! ␣

No further messages are sent until the error condition is cleared.

6.2.5 Prefix Setting

Some PURL commands are quite long. To speed command entry you can set a temporary command prefix. The prefix is automatically prepended to subsequent commands issued to the BenchMike Pro. You create a prefix by typing a partial command followed by a period. When a prefix is set, the BenchMike Pro responds with "PREFIX SET". To clear a prefix just send an extra CR. The BenchMike Pro will respond with "PREFIX CLEARED".

For example, to issue the commands:

```
CONF.SCANNER.FEAT.SEL:1 ␣
CONF.SCANNER.FEAT.INSERT ␣
CONF.SCANNER.FEAT.MEAS.LOWERREF:ON ␣
CONF.SCANNER.FEAT.MEAS.UPPERREF:ON ␣
```

you can enter the following:

```
CONF.SCANNER.FEAT. ␣ (setting prefix to CONF.SCANNER.FEAT.)
SEL:1 ␣
INSERT ␣
MEAS. ␣ (setting prefix to CONF.SCANNER.FEAT.MEAS.)
LOWERREF:ON ␣
UPPERREF:ON ␣
```

6.3 Command Descriptions

Note that the following tables list all commands in alphabetical order for simplicity. However, some commands must be issued prior to other commands. For example, you must select the desired feature number before you can alter the settings of that feature. A table is also given at the end of this section which lists all commands in the order they are most commonly used.

6.3.1 Configure Settings

With the CONFigure command, you can specify settings for the serial port, features, digital inputs and outputs, alarms, display, buttons, measurements, fixtures, and reports.

6.3.1.1 Configuring the Alarm: CONF.ALARM

The following table lists the options for configuring the alarms.

CONF.ALARM.DUR	Request or specify the duration of the alarm signal in seconds. Set the duration value to zero (0) to disable the alarm. Examples: CONF.ALARM.DUR:5 CONF.ALARM.DUR?
----------------	---

6.3.1.2 Configuring the Buttons: CONF.BUTTON

The following table lists the options for configuring the three large data buttons on the BenchMike Pro.

NOTE: The CONF.BUTTON.SEL command should be used to select the desired button before any MODE commands are issued.

CONF.BUTTON.MODE	Request or specify the mode of operation for the selected data button. Options include: GO/STOP, CLEAR_Data, CLEAR_LAST, PRINT, and SEND_DATA. Examples: CONF.BUTTON.MODE: CLEAR_DATA CONF.BUTTON.MODE?
CONF.BUTTON.SEL	Select the TOP, MIDDLE, or BOTTOM data button to the right of the touchscreen. Examples: CONF.BUTTON.SEL: TOP CONF.BUTTON.SEL: MIDDLE

6.3.1.3 Configuring the Digital Port: CONF.DIG

The following table lists the options for configuring the optional digital input and output.

NOTE: The CONF.DIG.INPUT.SWITCH.SEL command should be used to select the desired switch before any MODE commands are issued.

NOTE: The CONF.DIG.OUTPUT.ALARM.SWITCH.SEL command should be used to select the desired switch before any MODE commands are issued.

<p>CONF.DIG.INPUT. SWITCH.MODE</p>	<p>Request or specify the mode and function of a digital input. Both mode and function must be specified after the semi-colon. Possible modes are OFF (disable), TOG (toggle), NO (normally open), and NC (normally closed). Possible functions are OFF, GO/STOP, CLEAR_DATA, CLEAR_LAST, PRINT, SEND, CLEAR_LATCHED, FLOATING_NOMINAL , ADVANCE_FEATURE, BACKUP_FEATURE, EMERGENCY_STOP, ZERO_FIXTURE_1, HOME_FIXTURE_1, EOT_FIXTURE_1, ZERO_FIXTURE_2, HOME_FIXTURE_2, and EOT_FIXTURE_2. Examples:</p> <pre>CONF.DIG.INPUT.SWITCH.MODE:OFF GO/STOP CONF.DIG.INPUT.SWITCH.MODE:TOG GO/STOP CONF.DIG.INPUT.SWITCH.MODE:NO CLEAR_LAST CONF.DIG.INPUT.SWITCH.MODE:NC PRINT CONF.DIG.INPUT.SWITCH.MODE?</pre>
<p>CONF.DIG.INPUT. SWITCH.SEL</p>	<p>Select a digital input number for setup and/or query. This value can be between 1 and 8. Examples:</p> <pre>CONF.DIG.INPUT.SWITCH.SEL:1 CONF.DIG.INPUT.SWITCH.SEL?</pre>
<p>CONF.DIG.OUTPUT. ALARM.SWITCH.MODE</p>	<p>Request or specify the mode event to trigger the selected alarm output. First, the setting for the output must be defined. Options are: NO (normally open), and NC (normally closed). Second, the alarm can be NOT_LATCHED or LATCHED. There are several possible options for the mode event (the third input for this command). These are: REJECT_HIGH, WARNING_HIGH, WARNING_LOW, REJECT_LOW, GOOD, and END_OF_PART. Examples:</p> <pre>CONF.DIG.OUTPUT.ALARM.SWITCH.MODE:NO LATCHED REJECT_HIGH CONF.DIG.OUTPUT.ALARM.SWITCH.MODE: NC NOT_LATCHED END_OF_PART CONF.DIG.OUTPUT.ALARM.SWITCH.MODE?</pre>
<p>CONF.DIG.OUTPUT. ALARM.SWITCH.SEL</p>	<p>Request or specify the currently active alarm output. Examples:</p> <pre>CONF.DIG.OUTPUT.ALARM.SWITCH.SEL:1</pre>

	CONF.DIG.OUTPUT.ALARM.SWITCH.SEL?
--	-----------------------------------

6.3.1.4 Configuring the Scanner's Features: CONF.SCANNER.FEAT

The following table lists the options for defining the features in use by the BenchMike Pro.

NOTE: The CONF.SCANNER.FEAT.SEL command should be used to select the desired feature before any other commands are issued. The BenchMike Pro must be in STOP mode to accept any serial setup commands.

CONF.SCANNER.FEAT.ADV.MODE	<p>Select the advance feature mode event. Options are: GO, EOM, EOM_(LIMITS), and MANUAL. Examples:</p> <pre>CONF.SCANNER.FEAT.ADV.MODE:GO CONF.SCANNER.FEAT.ADV.MODE?</pre>
CONF.SCANNER.FEAT.DELETE	<p>Delete the currently selected feature. Examples:</p> <pre>CONF.SCANNER.FEAT.DELETE</pre>
CONF.SCANNER.FEAT.INSERT	<p>Insert a new feature after the currently selected feature. Examples:</p> <pre>CONF.SCANNER.FEAT.INSERT</pre>
CONF.SCANNER.FEAT.MEAS.AVG.MODE	<p>Request or specify the averaging type for the feature to SECONDS or SCANS. Examples:</p> <pre>CONF.SCANNER.FEAT.MEAS.AVG.MODE:SECONDS CONF.SCANNER.FEAT.MEAS.AVG.MODE?</pre>
CONF.SCANNER.FEAT.MEAS.DELAY.MODE	<p>Request or specify the units for the delay as SECONDS or SCANS. Examples:</p> <pre>CONF.SCANNER.FEAT.MEAS.DELAY.MODE:SECONDS CONF.SCANNER.FEAT.MEAS.DELAY.MODE?</pre>
CONF.SCANNER.FEAT.MEAS.DELAY.VAL	<p>Request or specify the delay time value for measurements with this feature. Examples:</p> <pre>CONF.SCANNER.FEAT.MEAS.DELAY.VAL:5 CONF.SCANNER.FEAT.MEAS.DELAY.VAL?</pre>
CONF.SCANNER.FEAT.MEAS.EXP	<p>Request or specify the expression string for this feature. This string contains each expression separated by a CR (ASCII 013). Examples:</p> <pre>CONF.SCANNER.FEAT.MEAS.EXP:f1.size=seg[2] CONF.SCANNER.FEAT.MEAS.EXP?</pre>
CONF.SCANNER.FEAT.MEAS.GLASS	<p>Enable (ON) or disable (OFF) Glass Logic measurements for use with transparent products. Examples:</p> <pre>CONF.SCANNER.FEAT.MEAS.GLASS:ON CONF.SCANNER.FEAT.MEAS.GLASS:OFF</pre>

CONF.SCANNER.FEAT. MEAS.LIMITS	<p>Enable (ON) or disable (OFF) the measurement limits for the feature. Use CONF.SCANNER.FEAT.MEAS.LIMITS.SEL to select the item to modify. Examples:</p> <pre>CONF.SCANNER.FEAT.MEAS.LIMITS:ON CONF.SCANNER.FEAT.MEAS.LIMITS:OFF</pre>
CONF.SCANNER.FEAT. MEAS.LIMITS.SEL	<p>Request or specify the type of measurement limit to be set by the .TOLVAL command. Applies only to this feature. Options are: +REJ, +WARN, -WARN, or -REJ. Examples:</p> <pre>CONF.SCANNER.FEAT.MEAS.LIMITS.SEL:+REJ CONF.SCANNER.FEAT.MEAS.LIMITS.SEL?</pre>
CONF.SCANNER.FEAT. MEAS.LIMITS.TOLVAL	<p>Request or specify the measurement tolerance value for the currently selected limit type. This is the amount of deviation from the nominal. The limit values used in other commands in this table are automatically computed with this value. Examples:</p> <pre>CONF.SCANNER.FEAT.MEAS.LIMITS.TOLVAL:0.500 CONF.SCANNER.FEAT.MEAS.LIMITS.TOLVAL?</pre>
CONF.SCANNER.FEAT. MEAS.NOM	<p>Request or specify the nominal part size for limits checking. Examples:</p> <pre>CONF.SCANNER.FEAT.MEAS.NOM:0.5000 CONF.SCANNER.FEAT.MEAS.NOM?</pre>
CONF.SCANNER.FEAT. MEAS.PART	<p>Turn “part mode” ON or OFF for this feature. When ON, the BenchMike Pro will stop measuring the part once it is removed from the measurement area. Examples:</p> <pre>CONF.SCANNER.FEAT.MEAS.PART:ON CONF.SCANNER.FEAT.MEAS.PART:OFF</pre>
CONF.SCANNER.FEAT. MEAS.AVG.VAL	<p>Request or specify the time period for measurements to be averaged. The time unit used is determined by .CONF.SCANNER.FEAT.MEAS.AVG. Examples:</p> <pre>CONF.SCANNER.FEAT.MEAS.AVG.VAL:200 CONF.SCANNER.FEAT.MEAS.AVG.VAL?</pre>
CONF.SCANNER.FEAT. MEAS.METHOD	<p>Request or specify the type of data sampling: SINGLE, CONTINUOUS, or PART. Examples:</p> <pre>CONF.SCANNER.FEAT.MEAS.METHOD:CONTINUOUS CONF.SCANNER.FEAT.MEAS.METHOD?</pre>
CONF.SCANNER.FEAT. MEAS.TYPE	<p>Request or specify the type of measurements to be taken for this feature. These options are listed under Measurement Type. Examples:</p> <pre>CONF.SCANNER.FEAT.MEAS.TYPE:DIAMETER CONF.SCANNER.FEAT.MEAS.TYPE?</pre>

<code>CONF.SCANNER.FEAT.SEL</code>	Select the number of the active feature. The number can range from 1 to 32. Examples: <code>CONF.SCANNER.FEAT.SEL:1</code> <code>CONF.SCANNER.FEAT.SEL?</code>
------------------------------------	--

6.3.1.5 Configuring the Feature's Fixture Measurement Parameters: **CONF.SCANNER.FEAT.FIX**

The following table lists the options for defining the Intelligent Fixtures for each feature.

NOTE: The `CONF.SCANNER.FEAT.SEL` command should be used to select the desired feature before any other commands are issued. The BenchMike Pro must be in STOP mode to accept any serial setup commands.

<code>CONF.SCANNER.FEAT.FIX.DISTANCE</code>	Specify the total distance to be traveled by the fixture. Examples: <code>CONF.SCANNER.FEAT.FIX.DISTANCE:10.0</code>
<code>CONF.SCANNER.FEAT.FIX.HOME</code>	Specify that the fixture will return to the Home position after measurement. Options are ON and OFF. Examples: <code>CONF.SCANNER.FEAT.FIX.HOME:ON</code>
<code>CONF.SCANNER.FEAT.FIX.MODE</code>	Request or specify the mode of operation for the fixture. Options are AUTO, MANUAL, and CONTINUOUS. Examples: <code>CONF.SCANNER.FEAT.FIX.MODE:AUTO</code> <code>CONF.SCANNER.FEAT.FIX.MODE?</code>
<code>CONF.SCANNER.FEAT.FIX.POSITIONS</code>	Request or specify the number of positions that the fixture must stop for measurements. Examples: <code>CONF.SCANNER.FEAT.FIX.POSITIONS:10</code> <code>CONF.SCANNER.FEAT.FIX.POSITIONS?</code>
<code>CONF.SCANNER.FEAT.FIX.ROTATIONS</code>	Request or specify the number of rotations of a rotary fixture when the MODE is CONTINUOUS. Examples: <code>CONF.SCANNER.FEAT.FIX.ROTATIONS</code>
<code>CONF.SCANNER.FEAT.FIX.SEL</code>	Request or specify the current fixture number. Examples: <code>CONF.SCANNER.FEAT.FIX.SEL:1</code> <code>CONF.SCANNER.FEAT.FIX.SEL?</code>
<code>CONF.SCANNER.FEAT.FIX.SHANK.DIAM</code>	Request or specify the shank diameter of the part being measured. This is used in computing the rotational speed for "belt drive" fixtures. Examples: <code>CONF.SCANNER.FEAT.FIX.SHANK.DIAM</code>

CONF . SCANNER . FEAT . FIX . SPEED	Request or specify the speed of rotation (in RPM) of the part being measured. Examples: CONF . SCANNER . FEAT . FIX . SPEED : 5 . 0 CONF . SCANNER . FEAT . FIX . SPEED ?
CONF . SCANNER . FEAT . FIX . STARTPOS	Request or specify the start position of a linear fixture. Examples: CONF . SCANNER . FEAT . FIX . STARTPOS
CONF . SCANNER . FEAT . FIX . STEPMODE	Request or specify whether half-stepping mode is on (HALF) or full steps only are permitted during rotation (FULL). Examples: CONF . SCANNER . FEAT . FIX . STEPMODE : FULL CONF . SCANNER . FEAT . FIX . STEPMODE ?
CONF . SCANNER . FEAT . FIX . USEMODE	Request or specify the fixture usage mode. Each fixture can be OFF, used to COLLECT data, or used to POSITION the fixture. To use a fixture for positioning, another fixture must be set to collect data. Examples: CONF . SCANNER . FEAT . FIX . USEMODE

6.3.1.6 Configuring the Batch: CONF.BATCH

The following table lists the options for batch measurements.

CONF . BATCH . CLEAR	All data is cleared when the Batch Size is reached, if this parameter is set to ON. When OFF is selected, the data is not cleared. Examples: CONF . BATCH . CLEAR : ON CONF . BATCH . CLEAR : OFF
CONF . BATCH . PRINT	All data is printed when the Batch Size is reached, if this parameter is set to ON. When OFF is selected, the data is not printed. Examples: CONF . BATCH . PRINT : ON CONF . BATCH . PRINT : OFF
CONF . BATCH . SIZE	Request or specify the number of readings composing one batch. Examples: CONF . BATCH . SIZE : 300 CONF . BATCH . SIZE ?

6.3.1.7 Configuring the Reports: CONF.REPORT

The following table lists the options for report format.

NOTE: The CONF.REPORT.SEL command should be used to select the desired report before any other commands are issued.

CONF.REPORT.MODE	Printed reports can be turned ON and OFF. Examples: CONF.REPORT.MODE:ON CONF.REPORT.MODE:OFF
CONF.REPORT.OUTPUT	Request or specify the output port used to transmit report data. Options are: PARALLEL, SERIAL_1, and SERIAL_2. Examples: CONF.REPORT.OUTPUT:PARALLEL CONF.REPORT.OUTPUT?
CONF.REPORT.SEL	Request or specify the type of report to be printed: SAMPLE, BATCH, FIXTURE_SAMPLE, or FIXTURE_BATCH. Examples: CONF.REPORT.SEL:SAMPLE CONF.REPORT.SEL?
CONF.REPORT.TITLE	Request or specify the title to be printed on the report. Examples: CONF.REPORT.TITLE:PRODUCT #12, 1ST SHIFT CONF.REPORT.TITLE?

6.3.1.8 Configuring the Serial Port: CONF.SER

The following table lists the commands used to configure the serial port.

NOTE: The CONF.SER.PORT command should be used to select the desired port before any other commands are issued. The BenchMike Pro must be in STOP mode to accept any serial setup commands.

IMPORTANT NOTE: Be careful to specify the correct baud rate when configuring the serial port. If you incorrectly define the baud rate, you will be unable to communicate with the BenchMike Pro until this is corrected.

CONF.SER.BAUD	<p>Request or specify the baud rate of the selected serial port. Values from 300 to 19200 are possible for either serial port. Examples:</p> <p>CONF.SER.BAUD:9600 CONF.SER.BAUD?</p>
CONF.SER.DBITS	<p>Request or specify the data bits of the selected serial port. This value can be either 7 or 8; the default value is 8. Examples:</p> <p>CONF.SER.DBITS:8 CONF.SER.DBITS?</p>
CONF.SER.FLOW	<p>Request or specify NONE, SOFT, or HARD data flow for the serial port, where SOFT = Xon/Xoff and HARD = CTS/RTS. Examples:</p> <p>CONF.SER.FLOW:NONE CONF.SER.FLOW?</p>
CONF.SER.FORMAT.AUTO	<p>Turn AutoSend ON or OFF. Examples:</p> <p>CONF.SER.FORMAT.AUTO:ON CONF.SER.FORMAT.AUTO:OFF</p>
CONF.SER.FORMAT.DECIMAL	<p>Turn the printing of periods in place of commas ON or OFF. Examples:</p> <p>CONF.SER.FORMAT.DECIMAL:ON CONF.SER.FORMAT.DECIMAL:OFF</p>
CONF.SER.FORMAT.DELAY	<p>Request or specify the time delay in seconds for serial data. Examples:</p> <p>CONF.SER.FORMAT.DELAY:5.0 CONF.SER.FORMAT.DELAY?</p>
CONF.SER.FORMAT.HEADER	<p>Request or specify the header used. Options are: NONE, SOH, STX, and EXCLAM, where SOH=ASCII 001, STX=ASCII 002, and EXCLAM=ASCII 033 (!) Examples:</p> <p>CONF.SER.FORMAT.HEADER:NONE CONF.SER.FORMAT.HEADER?</p>
CONF.SER.FORMAT.LABEL	<p>Turn the label for serial data ON or OFF. Examples:</p> <p>CONF.SER.FORMAT.LABEL:ON CONF.SER.FORMAT.LABEL:OFF</p>
CONF.SER.FORMAT.REQ	<p>Request or specify the REQ for serial data. Options are: CR, ENQ, and QUES. Examples:</p> <p>CONF.SER.FORMAT.REQ:CR CONF.SER.FORMAT.REQ?</p>
CONF.SER.FORMAT.SEP	<p>Request or specify the separator character for serial data.</p>

	<p>Options are: NONE, SPACE, COMMA, SEMICOLON, CR, LF, CR/LF, and TAB.</p> <p>Examples:</p> <pre>CONF.SER.FORMAT.SEP:NONE CONF.SER.FORMAT.SEP?</pre>
CONF.SER.FORMAT.SIGN	<p>Turn the inclusion of a +/- sign in front of a number ON or OFF. Examples:</p> <pre>CONF.SER.FORMAT.SIGN:ON CONF.SER.FORMAT.SIGN:OFF</pre>
CONF.SER.FORMAT.TERM	<p>Request or specify the termination character for serial data. Options are: NONE, CR, LF, CR/LF, and ETX. Examples:</p> <pre>CONF.SER.FORMAT.TERM:NONE CONF.SER.FORMAT.TERM?.CONF.SER.PAR</pre>
CONF.SER.FORMAT.TIME	<p>Turns the date/time stamp for serial data ON or OFF. Examples:</p> <pre>CONF.SER.FORMAT.TIME:ON CONF.SER.FORMAT.TIME?</pre>
CONF.SER.PAR	<p>Request or specify the parity of the selected serial port. Odd, even, and no parity are available. Examples:</p> <pre>CONF.SER.PAR? CONF.SER.PAR:E CONF.SER.PAR:O CONF.SER.PAR:N</pre>
CONF.SER.PORT	<p>Select a serial port number for setup and/or query. This value can be set to 1. Examples:</p> <pre>CONF.SER.PORT:1 CONF.SER.PORT?</pre>
CONF.SER.SBITS	<p>Request or specify the stop bits of the selected serial port. This value can be either 1 or 2. Examples:</p> <pre>CONF.SER.SBITS:1 CONF.SER.SBITS?</pre>

IMPORTANT NOTE: Be careful to specify the correct baud rate when configuring the serial port. If you incorrectly define the baud rate, you will be unable to communicate with the BenchMike Pro until this is corrected.

6.3.2 Getting Help

6.3.2.1 Help Commands: HELP

The following command lists all available help commands.

HELP	Request a listing of all supported PURL commands. Examples: HELP
------	--

6.3.3 Performing Measurements

6.3.3.1 Performing Measurements: MEAS

The MEASure command allows you to perform several operations related to measurements by BenchMike Pro.

MEAS.CLEARALL.NOW	This command will clear all data. Example: MEAS.CLEARALL.NOW
MEAS.CLEARLATCHED.NOW	This command will clear all latched alarms. Example: MEAS.CLEARLATCHED.NOW
MEAS.CLEARLAST.NOW	This command will clear the last measured data. Example: MEAS.CLEARLAST.NOW
MEAS.DATA	Enter a variable name followed by the equals sign to set the value. Example: MEAS.DATA:F1.NOMINAL=0.50 MEAS.DATA?F1.NOMINAL
MEAS.DEFINE.FORMAT	This command allows you to add a character string to the .MEAS.LAST.MEAS command. Example: MEAS.DEFINE.FORMAT? MEAS.DEFINE.FORMAT:New Product= [F1.SIZE] Avg= [F1.AVERAGE]
MEAS.LAST.MEAS	Request that the last, good formatted measurement be transmitted. Use MEAS.DEFINE.FORMAT to change or view the format of this data. Example: MEAS.LAST.MEAS?
MEAS.LISTVARS	Returns a CR/LF separated list of all defined variables and their value. Note that some will not contain

	<p>valid data unless the appropriate measurements have been taken. Examples:</p> <pre>MEAS.LISTVARS?</pre>
MEAS.RES	<p>Request or specify the measurement resolution (number of significant digits). Options are numbers 0 through 7. Examples:</p> <pre>MEAS.RES:5 MEAS.RES?</pre>
MEAS.ROUND	<p>Request or specify the measurement rounding. Options are: NEAREST, EVEN, 0/5, and TRUNCATE. Examples:</p> <pre>MEAS.ROUND:NONE MEAS.ROUND?</pre>
MEAS.SENDDATA.NOW	<p>Request the last measurement be transmitted. Use CONF.SER.FORMAT commands to change or view the format of this data.</p> <pre>MEAS.SENDDATA.NOW:</pre>
MEAS.START.NOW	<p>This command informs the BenchMike Pro to begin sending measurements from the scanner immediately. Example:</p> <pre>MEAS.START.NOW:</pre>
MEAS.STOP.NOW	<p>This command informs the BenchMike Pro to stop sending measurements from the scanner immediately. Example:</p> <pre>MEAS.STOP.NOW:</pre>
MEAS.UNITS	<p>Request or specify the measurement units. Options are: INCH (or IN), MILS (or MIL), MICROINCH (or UI), CM, MM, and MICRON (or UM). Examples:</p> <pre>MEAS.UNITS:MM MEAS.UNITS?</pre>

6.3.4 Checking System Status and Configuring Libraries

6.3.4.1 Monitoring Status: SYST

With the SYSTem commands, you can request information about the status of the measurement system.

SYST.BOOTVER	Request the bootloader firmware version. Example: SYST.BOOTVER?
SYST.DATE TIME	Request or specify the current date and time in this format: hh:mm:ss mm/dd/yyyy, where hh is measured in 24-hour time. Example: SYST.DATE TIME:08:00:00 01/21/2016 SYST.DATE TIME?
SYST.DISP.SCANNER.FEAT.SEL	This command will change the feature that is displayed on the BenchMike Pro's screen. You can specify the feature number, or you can move forward or backward through the numbers with the plus sign (+) or minus sign (-). Use + to advance to the next feature or - to move backward to the previous feature. If the last feature is currently selected, + will advance to the first feature. If the first feature is currently selected, - will move to the last feature. Examples: SYST.DISP.SCANNER.FEAT.SEL:3 SYST.DISP.SCANNER.FEAT.SEL? SYST.DISP.SCANNER.FEAT.SEL:+ SYST.DISP.SCANNER.FEAT.SEL:-
SYST.ID	On power up, this parameter is set to 0 (zero). If you have written your own application program to communicate with the gauge, the application program can set this value to a value other than 0 and can periodically read this parameter. If the gauge returns a value of 0, it will indicate that the gauge has been rebooted. This can also be used to distinguish different gauges (the serial number would differ as well). Example: SYST.ID?
SYST.LIBRARY.COMMON	Request the current common settings to be sent back as a response. This data can be saved to a file and sent back to the BenchMike Pro. The common

	<p>settings consist of the settings not included in the user libraries. See SYST.LIBRARY.USER and SYST.LIBRARY.SETTINGS. Example:</p> <p>SYST.LIBRARY.COMMON</p>
SYST.LIBRARY.INIT	<p>Initialize the current library. Example:</p> <p>SYST.LIBRARY.INIT</p>
SYST.LIBRARY.LIST-NAMES	<p>Request a list of names for all libraries which are not empty. Example:</p> <p>SYST.LIBRARY.LISTNAMES</p>
SYST.LIBRARY.NAME	<p>Define a name for the currently selected library. Example:</p> <p>SYST.LIBRARY.NAME:NEW PRODUCT</p>
SYST.LIBRARY.PRINT	<p>Print the currently active library. Use CONF.REPORT.OUTPUT to change or view the destination of the printout. Example:</p> <p>SYST.LIBRARY.PRINT</p>
SYST.LIBRARY.SAVE	<p>Save the currently active library settings. Example:</p> <p>SYST.LIBRARY.SAVE</p>
SYST.LIBRARY.SAVEAS	<p>Save the current settings to a new library ("Save As"). Specify the library number and the library name. Example:</p> <p>SYST.LIBRARY.SAVEAS:5 PRODUCT#5</p>
SYST.LIBRARY.SEL	<p>Request or specify the currently active library number. Ex.:</p> <p>SYST.LIBRARY.SEL:6</p>
SYST.LIBRARY.SETTINGS	<p>Request the current user library to be sent back as a response. This data can be saved to a file and sent back to the BenchMike Pro. This does not change the user master values stored in the BenchMike Pro when sent to the BenchMike Pro. See also SYST.LIBRARY.USER. Example:</p> <p>SYST.LIBRARY.SETTINGS?</p>
SYST.LIBRARY.USER	<p>Request the current user library to be sent back as a response. This data can be saved to a file and sent back to the BenchMike Pro. All library settings will be restored including user mastering. See also SYST.LIBRARY.SETTINGS. Example:</p> <p>SYST.LIBRARY.USER?</p>

SYST.SKILL	Request PURL version. Example: SYST.SKILL?
SYST.STAT.SCAN	<p>This command will return the status of the laser gauge. There are five characters to indicate the status.</p> <p>E Extra segments M Missing part L Low power O Scan overrun N No scan</p> <p>If the condition exists, a character will be returned in that location. If the condition does not exist, the character will be blank (character space). Example: SYST.STAT.SCAN?</p>
SYST.STAT.MEAS	<p>This command will return the current measurement status. There are seven characters.</p> <p>S Scan error E End of part M Measuring now R Upper reject reached R Lower reject reached W Upper warning reached W Lower warning reached</p> <p>If the condition exists, a character will be returned in that location. If the condition does not exist, the character will be blank (character space). Example: SYST.STAT.MEAS?</p>
SYST.VER	Request the application firmware version. Example: SYST.VER?
SYST.WIRED.ADDRESS	Request the IP address and Netmask of the unit. Example: SYST.WIRED.ADDRESS?

6.4 Table of Commands

Commands are listed here in the order they are most commonly used and in hierarchical order. For example, you must use the CONF.BUTTON.SEL command to select the desired button before you can change the mode with the CONF.BUTTON.MODE command.

Where commands may be equally used, they are listed in alphabetical order.

Configure alarms	CONF.ALARM.DUR
Configure buttons	CONF.BUTTON.SEL CONF.BUTTON.MODE
Configure the batch	CONF.BATCH.CLEAR CONF.BATCH.PRINT CONF.BATCH.SIZE
Configure digital inputs	CONF.DIG.INPUT.SWITCH.SEL CONF.DIG.INPUT.SWITCH.MODE
Configure digital outputs	CONF.DIG.OUTPUT.ALARM.SWITCH.SEL CONF.DIG.OUTPUT.ALARM.SWITCH.MODE
Configure scanner's features	CONF.SCANNER.FEAT.SEL CONF.SCANNER.FEAT.INSERT CONF.SCANNER.FEAT.DELETE CONF.SCANNER.FEAT.ADV.MODE CONF.SCANNER.FEAT.FIX.SEL CONF.SCANNER.FEAT.FIX.DISTANCE CONF.SCANNER.FEAT.FIX.HOME CONF.SCANNER.FEAT.FIX.MEASVER CONF.SCANNER.FEAT.FIX.MODE CONF.SCANNER.FEAT.FIX.POSITIONS CONF.SCANNER.FEAT.FIX.ROTATIONS CONF.SCANNER.FEAT.FIX.SHANK.DIAM CONF.SCANNER.FEAT.FIX.SPEED CONF.SCANNER.FEAT.FIX.STARTPOS CONF.SCANNER.FEAT.FIX.STEPMODE CONF.SCANNER.FEAT.FIX.USEMODE CONF.SCANNER.FEAT.MEAS.EXP CONF.SCANNER.FEAT.MEAS.GLASS CONF.SCANNER.FEAT.MEAS.INTERNALREF CONF.SCANNER.FEAT.MEAS.LOWERREF CONF.SCANNER.FEAT.MEAS.METHOD CONF.SCANNER.FEAT.MEAS.NOM CONF.SCANNER.FEAT.MEAS.PART CONF.SCANNER.FEAT.MEAS.TYPE CONF.SCANNER.FEAT.MEAS.UPPERREF CONF.SCANNER.FEAT.MEAS.AVG.MODE CONF.SCANNER.FEAT.MEAS.AVG.VAL CONF.SCANNER.FEAT.MEAS.DELAY.MODE CONF.SCANNER.FEAT.MEAS.DELAY.VAL

	<p>CONF . SCANNER . FEAT . MEAS . LIMITS . SEL</p> <p>CONF . SCANNER . FEAT . MEAS . LIMITS</p> <p>CONF . SCANNER . FEAT . MEAS . LIMITS . TOLVAL</p> <p>CONF . SCANNER . FEAT . MEAS . POS . OFFSET</p> <p>CONF . SCANNER . FEAT . MEAS . SIZE . OFFSET</p>
Configure report	<p>CONF . REPORT . SEL</p> <p>CONF . REPORT . MODE</p> <p>CONF . REPORT . OUTPUT</p> <p>CONF . REPORT . TITLE</p>
Configure serial port	<p>CONF . SER . PORT</p> <p>CONF . SER . BAUD</p> <p>CONF . SER . DBITS</p> <p>CONF . SER . FLOW</p> <p>CONF . SER . PAR</p> <p>CONF . SER . SBITS</p>
Configure serial data output	<p>CONF . SER . FORMAT . AUTO</p> <p>CONF . SER . FORMAT . DELAY</p> <p>CONF . SER . FORMAT . HEADER</p> <p>CONF . SER . FORMAT . LABEL</p> <p>CONF . SER . FORMAT . REQ</p> <p>CONF . SER . FORMAT . SEP</p> <p>CONF . SER . FORMAT . TERM</p> <p>CONF . SER . FORMAT . TIME</p>
Configure sound	<p>CONF . SOUND . VOL</p>
Help commands	<p>HELP</p>
Performing measurements	<p>MEAS . CLEARALL . NOW</p> <p>MEAS . CLEARLATCHED . NOW</p> <p>MEAS . CLEARLAST . NOW</p> <p>MEAS . DATA</p> <p>MEAS . DEFINE . FORMAT</p> <p>MEAS . LAST . MEAS</p> <p>MEAS . LISTVARS</p> <p>MEAS . RES</p> <p>MEAS . ROUND</p> <p>MEAS . SENDDATA . NOW</p> <p>MEAS . START . NOW</p> <p>MEAS . STOP . NOW</p> <p>MEAS . UNITS</p>
System commands	<p>SYST . BOOTVER</p> <p>SYST . DATETIME</p> <p>SYST . DISP . SCANNER . FEAT . SEL</p> <p>SYST . ID</p> <p>SYST . LIBRARY . COMMON</p> <p>SYST . LIBRARY . LISTNAMES</p> <p>SYST . LIBRARY . SEL</p>

	SYST.LIBRARY.INIT SYST.LIBRARY.NAME SYST.LIBRARY.SAVE SYST.LIBRARY.SAVEAS
System commands	SYST.LIBRARY.SEL SYST.LIBRARY.SETTINGS SYST.LIBRARY.PRINT SYST.LIBRARY.USER SYST.SKILL SYST.STAT.SCAN SYST.STAT.MEAS SYST.VER SYST.WIRED.ADDRESS

7 | Servicing Your Equipment

Your instrument was carefully inspected electrically and mechanically prior to shipment. It should be free of surface marks and scratches, and it should be in perfect working order upon receipt. If any indication of damage is found, file a claim with the carrier immediately, prior to using the instrument. If no damage is apparent, proceed by using this manual to install and setup this instrument.

Save the shipping carton and packing material for future storing or shipment of the instrument. If, at some future time, the instrument must be returned to the factory for service, include a full description of the instrument failure and the mode of operation the instrument was in at the time of failure. Also include a contact person to discuss the instrument failure.

When returning equipment for service, it is important to first obtain a Return Material Authorization (RMA) number. The RMA number is needed for proper handling of returned equipment.

- To obtain an RMA, go to <https://ndc.custhelp.com/>.
- Select **Service**
- Select **Equipment Return / RMA** from the drop-down menu. Follow the instructions to obtain an RMA.

Ship the instrument in the original carton, or, if the original carton is unavailable, ship in a carton providing sufficient protection. Send the instrument to the Asia, Europe, or USA office (addresses listed in the supplied Contacts/CE Compliance Manual), whichever is closest to you or to the office indicated by your sales engineer. Place the RMA number on the outside of the carton, and include a purchase order number and any other information specific to your instrument. Field warranty service is available, if the customer pays travel expenses by advance purchase order. All service operations should be performed by skilled electronics technicians, who have been trained by NDC Technologies.

8 | Specifications

8.1 Operational Specifications

Dimensions (H x W x D)	253 x 641 x 194 mm (10 x 25.24 x 7.7 in.)
Power Requirements	100–240 V AC, 50–60 Hz, 90 VA
Weight	24 kg (53 lbs.)
Operating Temperature	7–36 °C (45–97 °F) at 80% relative humidity for temperatures up to 31°C, decreasing linearly to 50% relative humidity at 40°C.
Storage Temperature	–20 to 60 °C (–4 to 140 °F)
Environment	For use indoors in a non-condensing environment; altitude up to 2000 m; no IP rating.
Installation category	II
Pollution degree	2

8.2 Performance Specifications

The following tables list performance specifications for the 2025 and 2050 BenchMike Pros, as well as separate specifications for each.

8.2.1 General BenchMike Pro Specifications (2025 and 2050)

Mounting Holes	Two (2) at Pass Line location; M6 (all others)
Setup Parameters	Saved in non-volatile memory (NVM)
Calibration	Factory calibrated
Laser Source	BenchMike Pro 2025/2050: 635 nm 1 mW collimated diode
Display	480 x 800 liquid crystal display; 16000 colors
Programmable Display Resolution	From X.1 to X.000001 in.
ScanRate	100 per second
Scan Digitizing	800 MHz
Operator Controls	Capacitive Touch screen keypad
Quadrature Encoder Input	Quadrature encoder input; maximum input rate, 900 KHz, accurate to ± 1 count
RS-232C Interface	Bi-directional interface for serial ASCII data; user-selectable baud rate to 38.4 KB; DB-9 pin connector
Serial USB interface	Looks like serial port to software
Ethernet RJ45	Supports network printing and software upgrade
Printer Interface	USB CUPS interface

Note that although the BenchMike Pro will operate as specified throughout the safe operating temperature range shown in the table above, the temperature of the part being measured can affect measurements. During factory calibration, measured parts are allowed to stabilize at standard conditions of 68°F (20°C) and 50% relative humidity. Your product may expand or contract based on its temperature. For best results, measure parts that have stabilized to these standard conditions. At all other temperatures, the size should be determined by using the coefficient of thermal expansion for the specific material composition of your product. (See the Troubleshooting section in the BenchMike Pro Operator Guide.) It is particularly important during mastering to ensure that your gauge pins have stabilized at standard conditions.

8.2.2 BenchMike Pro Model 2025 Specifications¹

Specification	Model 2025
Measurement Range	0.100 to 25.4 mm (0.004 to 1.0 in.)
Repeatability ²	±0.25 µm (±0.000010 in.)
Linearity ³	±0.9 µm (±0.000036 in.)
Measurement area depth of field	±0.75 x 25 mm (±0.030 x 1.0 in.)
Temperature coefficient	≤ ±0.008 µm/mm°C (≤±0.000004 in./in.°F)
Laser beam spot size	100 µm (0.004 in.)
Laser beam velocity	50 m/sec. (2,000 inch/sec.)

8.2.3 BenchMike Pro Model 2050 Specifications¹

Specification	Model 2050
Measurement Range	0.254 to 50 mm (0.010 to 2.0 in.)
Repeatability ²	±0.5 µm (±0.000020 in.)
Linearity ³	±1.5 µm (±0.000060 in.)
Measurement area depth of field	±1.5 x 50 mm (±0.060 x 2.0 in.)
Temperature coefficient	≤ ±0.008 µm/mm°C (≤±0.000004 in./in.°F)
Laser beam spot size	250 µm (0.010 in.)
Laser beam velocity	100 m/sec. (4,000 inch/sec.)

Notes:

¹ Specifications valid after a warm-up period of four hours in a stable temperature environment.

² Specified repeatability is the maximum deviation (±) from the mean value of 90 consecutive readings, with 2-second averaging. (A 2-second averaging reading is the average of 200 single scans.) Test conditions include using a gauge pin with a low coefficient of expansion, without removing the gauge pin and with minimal air flow around the working area of the BenchMike Pro.

³ Specified linearity confirmed using standard factory calibration @ 68 °F at 50% relative humidity. Testing conditions include a measured part composed of material with low coefficient of expansion, with minimal air flow

around the working area of the BenchMike Pro. The BenchMike Pro must be linearized by the factory yearly to maintain this specification.

8.3 Drawings

The drawings below indicate the measurement area of both models.

8.3.1 BenchMike Pro Model 2025

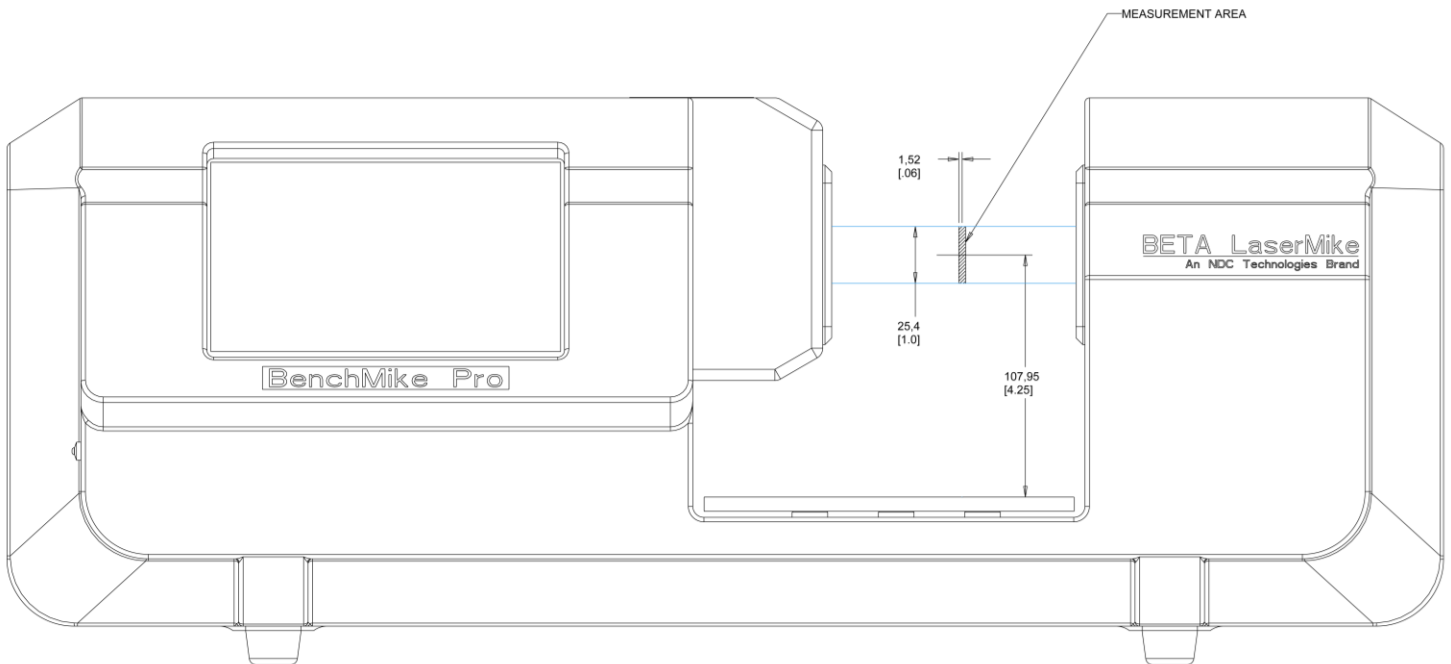

NOTE: Dimensions are in mm (inches).

8.3.2 BenchMike Pro Model 2050

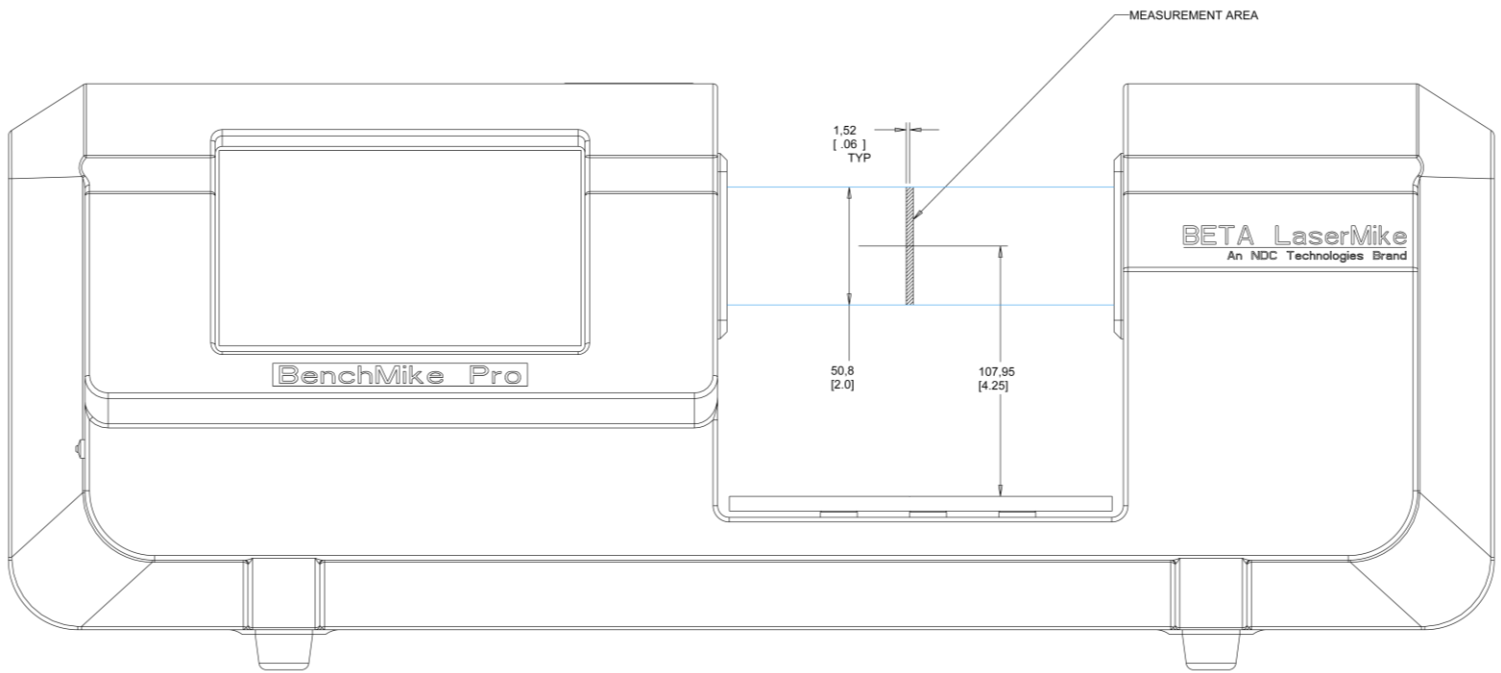

NOTE: Dimensions are in mm (inches).

8.4 Laser Beam Options

The following table lists the three options for the laser beam spot size.

Item	Description
0.001" Spot	Provides 0.001" (25.4 μm) spot size (beam diameter). Extends measurement range down to 0.001 in. and limits high end of the measurement range to 0.500 in. (12.7 mm). Factory-installed option.

Warranty

1. All sales of NDC Technologies products are subject to the contractual terms and conditions of the Order pursuant to which they were sold to Buyer, including Warranty terms. The following terms are a general summary of the contractual Warranty terms, NOT a revision or alternative to the contractual terms, and are presented as merely a point of reference for your information. The contractual Warranty is the complete and exclusive statement of all NDC Technologies warranties to Buyer. In the event the following terms are in conflict with any of the contractual Warranty terms, the contractual Warranty terms shall be deemed to control.

The warranty terms contained herein are expressly in lieu of any and all other warranties, expressed or implied, including any warranty of merchantability or fitness for a particular purpose. In no event shall NDC Technologies be liable for any incidental, consequential or special damages, including but not limited to, any loss of business, income or profits, expenses incurred for time when the system is not in operation, and any labor costs relating to or arising out of the performance, functioning or use of the system.

Purchaser assumes the risk for use of this product and agrees to indemnify and hold NDC Technologies harmless for any and all damage to person or to property resulting therefrom.

NDC Technologies grants no license under any patent rights except the right, under only such patents as may be owned or acquired by NDC Technologies, to use the product sold hereby for the purpose for which it is sold. NDC Technologies does not warrant that the product or its use does not infringe any patent owned by persons other than NDC Technologies.

2. For a period of one (1) year from the date of delivery, NDC Technologies guarantees all products to be free from defects in material and workmanship. During this period, NDC Technologies will repair or at its option replace, free of all charges for parts and labor, any NDC Technologies parts determined by it to have been broken or damaged due to causes other than improper application, abuse or negligence. NDC Technologies' obligation to repair or replace shall not extend to expendable parts which are subject to normal operating wear. Nothing in this paragraph 2 will require NDC Technologies to make repairs or replacements where:
 - A. The product has been repaired, other than by an authorized NDC Technologies dealer or an NDC Technologies employee, or altered in any way without the prior written consent of NDC Technologies; or
 - B. The product has not been properly maintained in accordance with any operating and maintenance manual supplied therewith; or
 - C. The product has been damaged as a result of fire, flood, war, insurrection, civil commotion, acts of God or any other cause beyond the control of NDC Technologies or Buyer.
3. NDC Technologies' liability shall be limited to the obligations set forth in Paragraph 2. These shall be the Buyer's sole and exclusive remedies, whether in contract, tort or otherwise, provided, however, that in lieu thereof, NDC Technologies at its option may replace the entire product on an exchange basis or refund the purchase price against the return of the defective product.
4. NDC Technologies will not be responsible for failure to provide service or parts due to shortage of materials, labor or transportation strikes or delays, or any causes beyond NDC Technologies' control.
5. Unless otherwise specified by NDC Technologies, all warranty repairs will be made at NDC Technologies' facility. The customer shall be responsible for all expenses of packing, freight and insurance in connection

with the shipment of products to NDC Technologies for repair. NDC Technologies will pay the cost of returning the equipment to customer.

If it is mutually determined by the buyer and NDC Technologies that the examination, replacement or repair takes place at the buyer's facility, then the buyer will be responsible for NDC Technologies' travel and living expenses incurred in traveling to and from the buyer's facility, and during the time of the visit, as well as the cost of field labor and replacement parts unless the parts being repaired or replaced are determined to have been defective, in which event the cost of said repaired or replacement parts shall be borne by NDC Technologies. These travel and living expenses will be billed to the buyer at actual cost to NDC Technologies.

6. No person, including any NDC Technologies distributor, agent or representative, is authorized to assume any liability on behalf or in the name of NDC Technologies, and NDC Technologies shall not be bound to any understandings, representations, or agreements with respect to warranties except as set forth in this policy.
7. NDC Technologies requests immediate notification of any claims arising from damage in transit in order to determine if carrier responsibility exists. If damaged equipment arrives, save the shipping container for inspection by the carrier and telephone NDC Technologies as soon as possible.

Index

About	4-43	Measurement Method	4-34
Actual Temperature	4-40	Measurement Type	4-32
Advanced Screen Capabilities	5-6	Measuring a Product	1-3
Average	4-39	Measuring Transparent Products	1-5
Batch	4-39	Minimum	4-39
Batch Report.....	4-19	Mode Icon	4-4
Button Setup.....	4-7	Nominal/Limits Limits	4-38
Calibration	1-2	Nominal/Limits Nominal Setup	4-37
Connections.....	2-7	Nominal/Limits Tolerances	4-38
Count	4-39	Non-Intelligent Fixture Option.....	3-1
Custom Measurement Properties	5-10	Non-Printable Characters	6-1
Custom Measurements.....	5-8	Operational Specifications.....	8-1
Data Buttons.....	4-1	Options.....	1-1
Data Functions	4-37	Part Count.....	4-38
Data Processing and Display	1-6	Part Mode	4-34
Deviation.....	4-37	Part Position.....	4-39
Diff/TIR	4-39	Part Size	4-39
Digital I/O Connector	2-7	Performance Specifications.....	8-1, 8-4
Digital Inputs.....	2-9, 4-8	Printer Connector	2-11
Digital Outputs	2-9, 4-8	PURL	6-1
Display Setup	4-9	Quadrature Encoder.....	2-12
Drawings.....	2-2	Reports	4-16
Dual Point Mastering	4-36	Resolution	4-25
Equipment Maintenance	2-1	Rounding.....	4-25
Expression Editor.....	5-1	Sample Report	4-18
Feature Functions.....	4-26	Save Function	4-41
Feature Icon	4-5	Scan Errors Configuration	4-48
Fixture	4-9	Scanner Configuration.....	4-47
Fixture Batch Report.....	4-21	Screen Configuration.....	4-47
Fixture Connector	2-11	Security Page.....	4-46
Fixture Sample Report.....	4-20	Security Setup.....	4-45
Fixtures.....	3-2	Serial Connector	2-10
Footswitch	5-10	Serial Data Out Format	4-23
General Purpose Fixed V-Block Fixture	3-2	Settings Functions.....	4-16
Intelligent Fixture Option:	3-2	Setup Menu.....	4-7
International Configuration.....	4-48	Single Point Mastering	4-36
Laser Beam Options	8-5	Sources of Error	1-4
Laser Safety	1-7	SQC	4-39
Library Functions	4-14	Standard Deviation.....	4-39
Lock	4-43	Status Menus	4-42
Lock Page.....	4-46	System Functions.....	4-7
Maintenance	2-1	System Password	4-46
Master Measurement.....	4-36	Thermal Compensation Setup.....	4-24
Maximum.....	4-39	Tolerance and Limit Checking Display Capabilities.....	5-7
Measurement Functions	4-28	Touch Screen.....	4-1
Measurement Icon	4-6		

Units4-25
Universal Slide Fixture3-3

Ventilation Requirements 2-1