

**Magnetoflow®
Mag Meter**

**Sanitary Meter
with Model Primo® 3.1**

**Installation &
Operation Manual**



SCOPE OF THIS MANUAL

This manual contains information concerning the installation, operation and maintenance of Badger's Magnetoflow® electromagnetic flow meter models with Primo® Amplifier.

To ensure proper meter performance, the instructions given in this manual should be thoroughly understood. Keep a copy of this manual in a readily accessible location for future reference.

TABLE OF CONTENTS

System Description	2
Unpacking and Inspection	2
Transportation and Handling	2
Meter Installation	3
Specifications - Detector	5
Grounding	6
Specifications - Amplifier	6
Wiring	7
Programming	9
Unit of Measure	9
Full Scale Setting (Maximum Flow)	10
Low Flow Cutoff	10
Empty Pipe Detection	11
Flow Direction	11
Filter Dampening	12
Error List (Messages)	12
Resetting of Totalizers	12
Analog Outputs	13
Pulse Outputs	14
Wiring of AMR unit to Mag	14
Frequency Output	15
Flow Alarms	15
Detector Factor Field Calibration	15
Accuracy Test	16
Meter/Pipe Size	16
Password Protection	16
Language Selection	16
Troubleshooting	17
Error Message Explanation	18
Board Assembly Replacement	19
Fuse Replacement	19

SYSTEM DESCRIPTION

Magnetoflow® electromagnetic flow meters are intended for fluid metering in most industries including water, wastewater, food and beverage, pharmaceutical and chemical.

The basic components of an electromagnetic flow meter are two: 1) The Detector; which includes the flow tube, isolating liner and measuring electrodes, and 2) the Amplifier, which is the electronic device responsible for the signal processing, flow calculation, display and output signals.

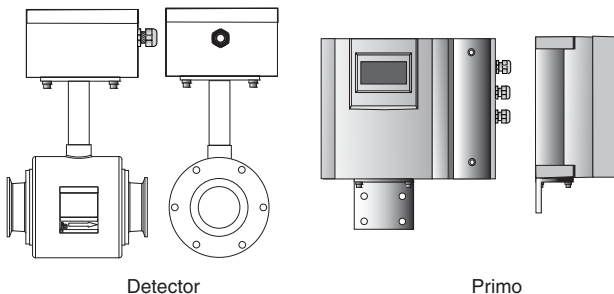

The materials of construction of the wetted parts (liner and electrodes) should be appropriate for the specifications on the intended type of service. Review of the compatibilities consistent with the specifications is recommended.

All Badger's Magnetoflow mag flow meters are factory tested and calibrated. A calibration certificate is included in the shipment of each meter.

UNPACKING AND INSPECTION

Magnetoflow mag flowmeters are shipped in special shipping containers. Upon receipt of the meter, perform the following unpacking and inspection procedures. If damage to the shipping container is evident, be present when the meter is unpacked.

- Carefully open the shipping container following any instructions that may be marked on the exterior. Remove all cushioning material surrounding the meter.
- Retain the shipping box and all packing materials for possible use in reshipment or storage.
- Visually inspect the meter for any physical damage such as scratches, loose or broken parts, or any other sign of damage that may have occurred during shipment.

NOTE: If damage is found, request an inspection report by the carrier's agent within 48 hours of delivery. Then file a claim with the carrier. A formal claim for equipment damaged in transit is the responsibility of the customer.

- Verify that the meter received is consistent with the product ordered. The detail on the product labels on the detector and the amplifier should help this verification.
- All detectors with PTFE liner are shipped from the factory with a liner protector. This protector maintains the proper form of the PTFE material and protects it during shipping and storage. Do not remove this protector until you are ready to install the unit.
- Storage: If the meter is not to be immediately installed, store it in its original container in a dry, sheltered location. Storage temperature: -4 to 158 °F (-20 to 70 °C)

METER INSTALLATION

METER LOCATION GUIDELINES

The following are several guidelines for determination of a good location for meter installation:

Temperature Ranges

In order to prevent damage to the meter, the maximum temperature ranges must be observed.

Primo® Amplifier

Ambient temperature: -4 to 140°F (-20 up to +60°C)

Detector

Fluid temperature: -40 to 311°F (-40 up to +155°C)

Outdoor Installations - Primo Amplifier

The Primo Amplifier can be installed outdoors but with a few requirements:

- The ambient environment must not be out of the temperature ratings for the unit. (-4 to 140 degrees F)
- The Primo must be protected to some degree from the outside elements. At a minimum, a roof or shield of sorts should be fabricated over the unit to protect the LCD display from the sunlight. It will also keep the unit out of the possibility of a hard sustained rain which could cause moisture to get into the unit. An alternative approach would be to simply mount the unit in a "Hoffman style" outdoor enclosure, eliminating the potential of either issue arising.

If an indoor environment is within 250 feet of the Mag meter installation, consideration should be given to increase the cable length and mount the Primo indoors.

Chemical Injection Applications

For water line applications with a chemical injection point, the meter should be installed upstream of the chemical injection point to eliminate any issues with the meter performance. If an upstream location is not possible for the meter, consider moving the injection point downstream of the meter location. If the meter must be installed downstream of the chemical injection point, the distance between these (2) locations must be significant; frequently 50 - 100 feet.

When the solution made up of the water and the injected chemical reach the Mag meter, it must be a complete homogeneous mixture. If too close, the Mag meter will sense (2) different liquids (conductivity different for each) and will be confused as to how to process the information. Many other factors such as the type of injection method, (spaced bursts versus continuous stream of drops), or whether the chemical is injected in a liquid or gas form, can cause a wide variation in the distance required from one application to another.

Due to this wide range of factors, it is difficult to specify a distance that will always work for any application without establishing a value far in excess of what would usually be required. Please contact Badger Meter's Technical Support at 1-800-616-3837 with your application detail and they can assist in determining if the Mag meter should properly perform. As noted, the meter may require 50 - 100 feet from the injection point to assure the complete homogeneous state.

Submersible Option

If the meter is to be installed in a meter vault, it should be installed to be sure the amplifier is not inside the vault.

Other Considerations

Avoid all pipe locations where the flow is pulsating, such as in the outlet side of piston or diaphragm pumps.

Avoid locations near equipment producing electrical interference such as electric motors, transformers, variable frequency, etc.

Install the meter with enough room for future access for maintenance purposes.

The mag meter isolating liner is not intended to be used as gasket material. Standard gaskets (not provided) should be installed to ensure a proper hydraulic seal. When installing the gaskets, make sure they are properly centered to avoid flow restriction or turbulence. Do not use graphite or any electrically conductive sealing compound to hold the gaskets in place during installation. This could affect the reading accuracy of the measuring signal.

STRAIGHT PIPE REQUIREMENTS

For optimum accuracy performance, it is required to provide sufficient inlet and outlet straight pipe runs. An equivalent to 3 diameters of straight pipe is required on the inlet side, and 2 diameters on the outlet side. There are no special requirements for standard concentric pipe reducers.

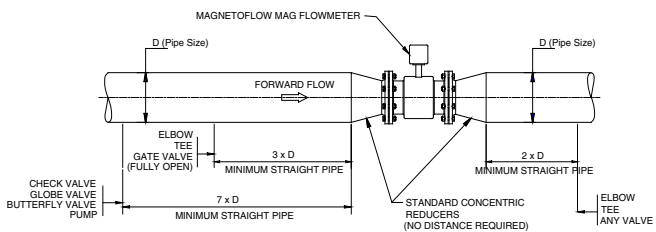

By using pipe reducers, a smaller meter size can be mounted in larger pipeline sizes. This may also increase low flow accuracy performance.

In order to minimize flow disturbances and excessive loss of head, custom fabricated pipe reducers must have a minimum slope angle of 15 degrees. If this is not possible, install the custom pipe reducers as if they were fittings, leaving the minimum straight pipe required.

Mounting Location

The detector should never be installed on the suction side of a pump where a vacuum exists to eliminate the possibility of damage to the liner.

If vibration exists on the pipeline, secure the piping before and after the meter. If a strong vibration exists, the amplifier should be mounted remotely. Do not install cables near power cables, electrical ma-

chines, etc. Be sure both ends of signal cable are securely fastened. Run power and signal cables in separate conduit.

METER ORIENTATION

Magnetoflow Mag Meters can operate accurately in any pipe line orientation.

However, the most recommended installation position is vertical piping, with the the liquid flowing upward.

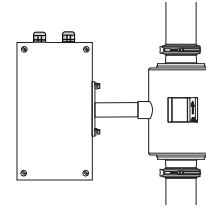

FIG. 1 VERTICAL PIPE MOUNTING
HIGHLY RECOMMENDED

This installation practice ensures two objectives:

- The pipe remains completely full of liquid, even at low flow, low pressure applications with a discharge to the atmosphere.
- Solid build-ups or sediments that could be part of the process fluid will not deposit or accumulate on the liner and/or electrodes.

The model Magnetoflow® Sanitary meter is designed to measure flow in bi-direction only. **Carefully observe the "forward flow" label attached to the meter body and install the meter accordingly.**

PIPING CONFIGURATION

Appropriate piping arrangements should be provided to ensure the meter is not exposed to extreme pipe vibrations. The piping arrangements should include appropriate pipe supports.

For optimum accuracy performance, it is required to provide sufficient inlet and outlet straight pipe runs. An equivalent of 3 diameters of straight pipe is required on the inlet side of the meter, and 2 diameters on the outlet side, measured from the center of the meter body.

Avoid installing the detector close to flow disturbance generating valves and fittings.

Do not install the detector in the outlet side of Piston or Diaphragm type pumps. Avoid all pipe locations where the flow is pulsating. Avoid installing the detector in the suction side of any pumps; possible creation of vacuum can affect meter performance or cause damage to the PTFE liner.

TEMPERATURE

Note: Environmental temperature of installation is not to exceed maximum specification of 122°F (50°) for the Primo amplifier.

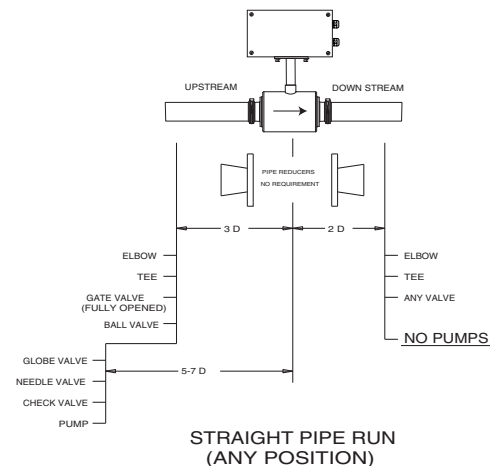

PARTIALLY FILLED PIPE SITUATIONS

Magnetoflow® mag meters are designed to operate in closed, full pipes.

It is relatively common to encounter situations where the process pipe will remain momentarily partially filled due to certain hydraulic conditions. Examples of this include discharge to the atmosphere (lack of back pressure), insufficient line pressure, gravity flow applications, etc.

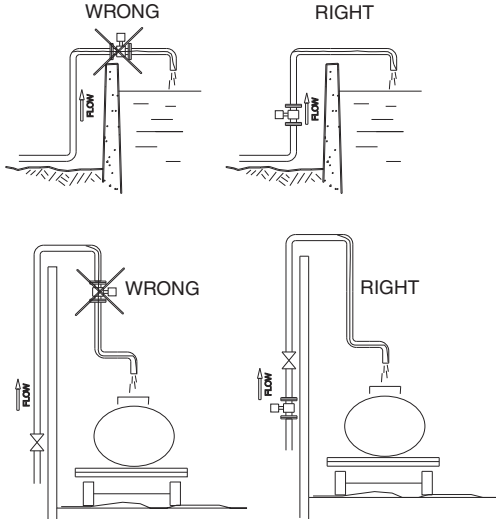

To eliminate the negative effect of these situations on the performance of the mag meter, observe the following guidelines:

- Avoid installing the detector in the highest point of the pipe line
- Do not install the detector in vertical, downward flow sections of the pipe
- ON/OFF valves should ALWAYS be located on the downstream side of the meter
- Select the recommended vertical orientation with flow upwards whenever possible
- Make sure that the flow range of the meter size selected is consistent with the application flow range

To minimize the possibility of partially full pipe flows in horizontal, gravity or low pressure applications, it is recommended to create a pipe arrangement as shown in the figure below. This arrangement ensures the detector remains full of liquid at all times.

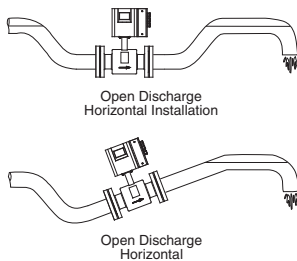

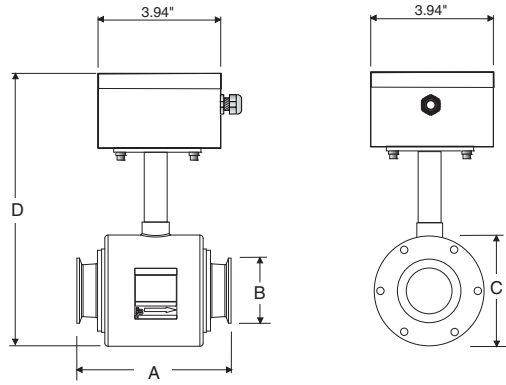

Meter with junction box for remote Primo® converter

		A		B		C		D		Est. Weight with Primo		Flow Range			
		GPM		LPM						Lbs	Kg	Min	Max	Min	Max
inches	mm	inch	mm	inch	mm	inch	mm	inch	mm						
3/8"10	7.1	.180	.992	25.2	2.8	70	8.3	210	12	5.5	0.034	11.4	0.13	43	
1/2"15	7.1	.180	.992	25.2	2.8	70	8.3	210	12	5.5	0.06	20	0.23	76	
3/4"20	7.1	.180	.992	25.2	2.8	70	8.3	210	12	5.5	0.13	45.4	0.52	171	
1"	25	7.1	180	1.984	50.4	2.8	70	8.3	210	13	6	0.24	80	0.92	305
1 1/2"	40	7.9	200	1.984	50.4	3.5	89	9.3	235	15	7	0.6	181	2.1	687
2"	50	7.9	200	2.516	63.9	4.1	104	9.8	250	17	7.5	1.0	323	3.7	1223
2 1/2"	65	10.6	270	3.047	77.4	5.1	129	10.6	270	20	9	1.5	504	5.8	1910
3"	80	10.6	270	3.579	90.9	5.5	140	11.0	280	23	10.5	2.2	727	8.3	2751
4"	100	10.6	270	4.682	118.9	6.3	160	11.8	300	24	11	4.0	1292	14.8	4892

SPECIFICATIONS

Flow Range: 0.1 - 33 fps (0.03-10 m/s)
Sizes: 3/8" to 4" (10 to 100 mm)
Min. Conductivity: ≥ 0.5 micromhos/cm
Accuracy: ≥ 0.25% accuracy of rate from 1-33 fps.
 ≥ 0.5% accuracy of rate from .1-1 fps.
Electrode Material: Alloy C
Liner Material: PTFE
Max. Fluid Temperature: 311°F, (155°C)

Pressure Limits: 150 psi (10Bar)
Coil Power: Pulsed DC
Ambient Temperature: -4°F to 122°F, (-20°C to 50°C)
Meter Enclosure Material: Stainless Steel 316
End Connections: Tri-clamp (sizes 1"-4" per ISO 2852)
Junction Box Enclosure Protection: Stainless Steel, Nema 4X
Cable Entries: 1/2" NPT Cord Grip
Remote Amplifier Enclosure: NEMA 4

PRIMO® AMPLIFIER (3.1 ELECTRONICS)

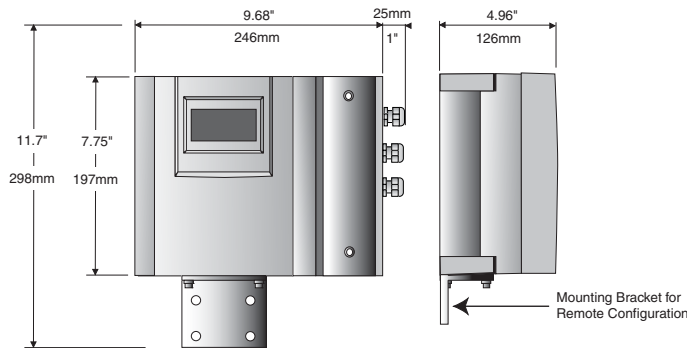

SPECIFICATIONS

Power Supply: 85-265 VAC, 45-65 Hz
Power Consumption: 20W
Accuracy: ± 0.25% accuracy of rate from 1-39.4 fps.
 ± 0.5% accuracy of rate from 0.1-1.0 fps.
Repeatability: 0.1%
Minimum Fluid Conductivity: 5.0 micromhos/cm
Flow Direction: Unidirectional or bidirectional, 2 separate totalizers (programmable)
Analog Outputs: 0/4-20mA, 800ohms Max Load
Output Frequency: Scaled Pulse output, (open collector) Max 5Khz
Digital Outputs:
 Voltage sourcing transistor, 24VDC, 100mA max
 (3) AC electro-mechanical relays, 48VAC, 0.5 amp max

Outputs: All outputs are short circuit safe
Noise Dampening: Programmable from 1 to 6
Pulse Width: Programmable up to 500ms
Galvanic Isolation: ≤ 500V
Zero-point Stability: Automatic correction
LCD Display: 4 lines x 16 character back-lit alphanumeric
 Displays (2) Totalizers, Flow Rate, Alarm conditions
Housing: Cast aluminum, powder coated paint
Housing Rating: NEMA 4X
Mounting: Detector mount or remote mount (bracket supplied)
Cable Connection: 1/2" NPT Cord Grip
Ambient Temperature: -4 to 140° F (-20 to 60° C)
Serial Communication: RS232

WIRING

At installation, be sure to comply with the following requirements:

IMPORTANT!

- Disconnect power to the unit before attempting any connection or service to the unit
- Do not bundle or route signal lines with power lines
- Keep all lines as short as possible
- Use twisted pair shielded wire for all output wiring
- Observe all applicable local electrical codes

For the AC power connections use three wire sheathed cable with overall cable diameter of 0.2" to 0.45" (5mm to 12mm). For signal output use 18 to 22 gauge (0.25 mm² to 0.75mm²) shielded wire. Overall cable diameter between 0.12" to 0.35" (3mm to 9mm).

WIRING FOR REMOTE PRIMO® CONFIGURATION

Wiring between the detector and the Primo amplifier comes complete from the factory. If your installation requires the use of conduit, the following are recommended steps for wiring of the detector to the amplifier.

1. Remove the junction box lid. Carefully remove the wires connected to the terminal blocks that run to the Primo amplifier. Note which wire goes into which terminal. The chart below may be of assistance for reference of wire color and terminal connection.
2. Run cable through conduit from Primo amplifier location, retaining the wiring of the cable to the amplifier as supplied.
3. Complete conduit assembly on both ends and rewire cable into junction box as wired when received. See wiring diagram below.

Connection No.	Description	Wire color
11	Coil	Green
12	Coil	Yellow
13	Main Shield	Yellow/green
45	Electrode	White
44*	Electrode Shield	Black
46	Electrode	Brown
40	Empty Pipe	Pink
44*	Empty Pipe Shield	Black

*Connections with the No. 44 are lying on the same potential

Remote style Primo Amplifier models can be ordered with longer cable than our standard stock lengths of the standard cable; 15, 30, 50 and 100 feet. The following chart shows the cable style options and the maximum flow medium temperature that can exist in the application environment at a given length of that cable.

	Cable Length (Ft)	Cable Size		
		Standard	Medium	Large
		AWG 23 0.25mm ²	AWG 20 0.50mm ²	AWG 18 0.75mm ²
		Fluid Temperature		
	100	311F	311F	311F
	125	306F	311F	311F
	150	294F	311F	311F
	175	283F	311F	311F
	200	271F	311F	311F
	225	260F	312F	311F
	250	249F	306F	311F
	275		300F	311F
	300		295F	311F
	325		289F	311F
	350		283F	311F
	375		278F	309F
	400		272F	305F
	425		266F	302F
	450		260F	298F
	475		255F	294F
	500		249F	291F

Empty Pipe Detection Considerations

Cable Length (ft)	Minimum Conductivity Required (μS/cm)
0-99	5
100	20
500	100

Wiring for Remote Primo Configuration

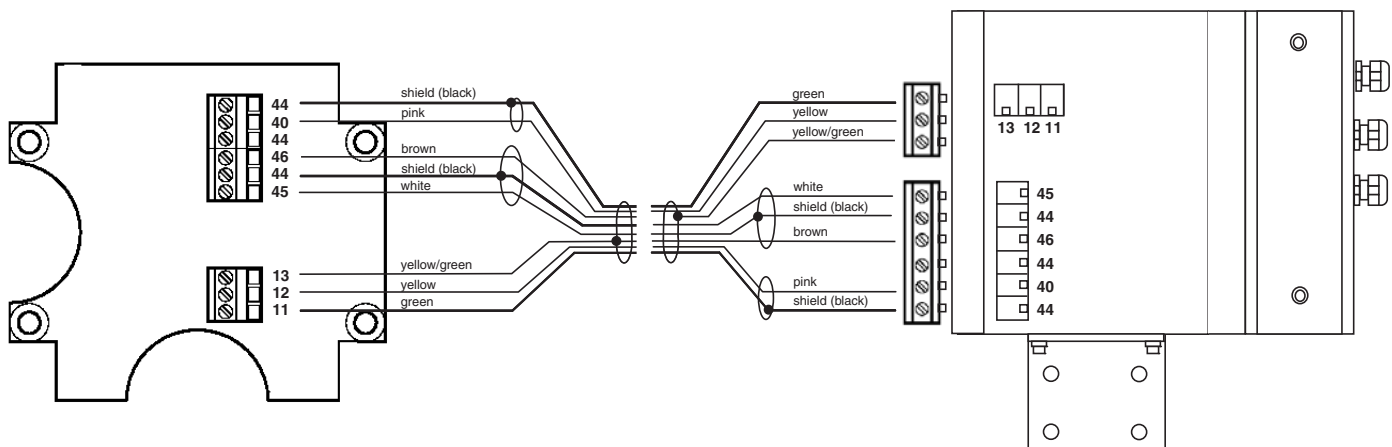

WIRING INPUTS AND OUTPUTS TO THE PRIMO® AMPLIFIER

Once the wiring between the sensor and the amplifier is done proceed to wire any inputs and outputs to the Primo amplifier.

IMPORTANT! For safety reasons leave AC power connections to the unit as the last step. Follow all the safety precautions and local code to prevent electrical shock and/or damaging of the electronic components.

1. Loosen the two bolts on the red amplifier cover. Remove the cover. Inside the amplifier you will see a terminal strip similar to the one depicted in the figure to the right.

POWER

⚠ CAUTION

To prevent accidents, power connection should be made only after all other connections have been completed.

The PRIMO amplifier is a microprocessor based device. It is **important that the power supply be as "clean" as possible.** Avoid using power lines that feed heavy loads such as pumps, motors, etc. If dedicated lines are not available, a filtering or isolation system might be required.

It is recommended that the internal fuse protection be maintained. Use a 2 amp slow blow fuse.

How to connect the amplifier to remote digital indicators/totalizers that do not require external power supply

This connection is intended for use with indicators that do not require an external power supply such as the ER series indicators from Badger Meter. For the ER-6, ER-8 or ER-9, connect terminal 15 of the Amplifier to terminal 2 of the ER series and terminal 16 to ground or terminal 1 of the ER indicator.

For connection to the PC 100 Controller, connect terminal 15 of the amplifier to terminal 14 of the PC 100 and terminal 16 of the amplifier to terminal 12 of the PC 100.

Board Accessible with Red Cover Removed

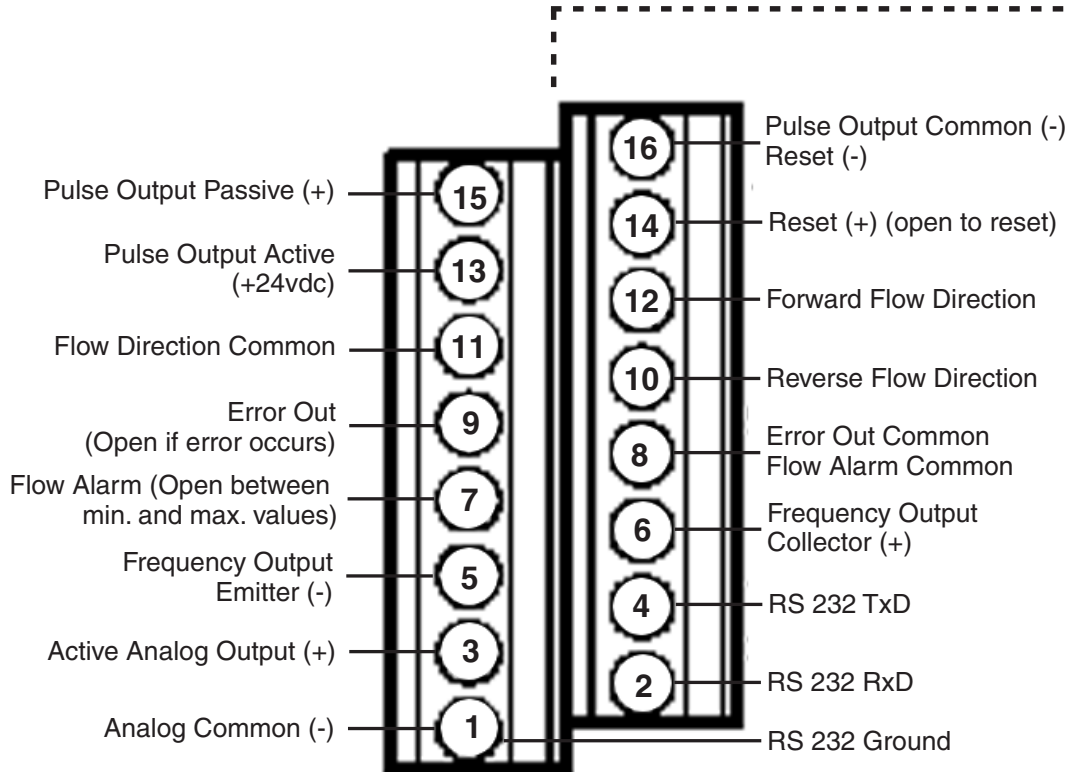
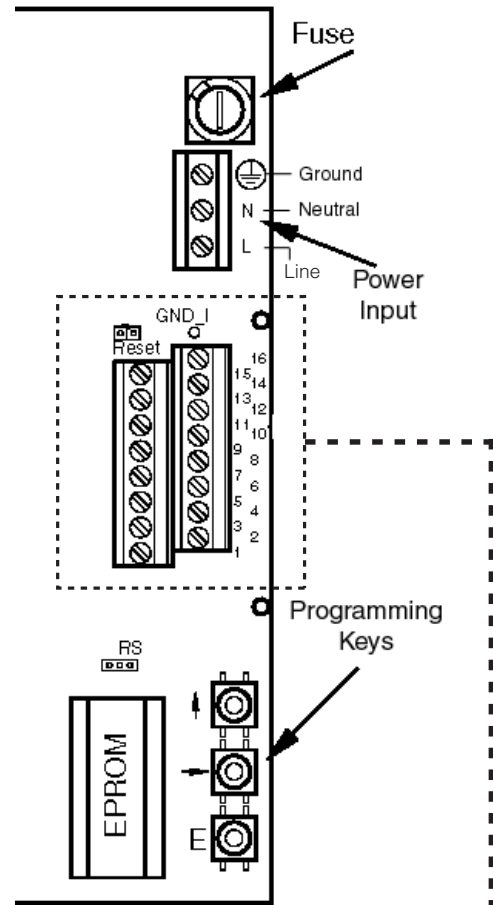

PROGRAMMING (3.1 Electronics)

The Primo® amplifier comes preprogrammed from the factory and in most instances will not require any additional manipulation. However, if you will be using the flow signal outputs or need to reprogram the meter to suit your particular needs, it will be necessary to familiarize yourself with the programming procedures.

Programming of the Primo amplifier is very simple

This section gives step by step instruction on how to program each of the functions of the amplifier and an explanation of the choices that are available for each one.

First, using a small flat screwdriver, remove the red cover from the main amplifier housing. At the lower right corner of the unit you will see three square buttons. These buttons are used to perform all programming procedures.

Programming Keys

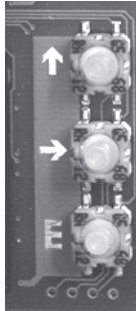

NOTE: The programming buttons have been placed inside the amplifier enclosure to prevent tampering or accidental reprogramming of the unit. After programming, be sure to reassemble the red cover on the enclosure.

The four line 16 digit LCD display of the Primo amplifier will guide you through each of the programming options/steps. The main screen will display:

1st Line: Flow Rate
2nd Line: Totalizer (TOT+ or TOT1)
3rd Line: Totalizer (TOT- or TOT2)
4th Line: Displays revision of software to assist in troubleshooting. This line is also used to display any error messages that may occur during operation of the meter.

The main display screen will be in one of the following modes. (See Flow Direction on page 11 for additional detail.)

Uni-Directional Mode

```
RATE 0.0000 GPM
TOT1 1000 G
TOT2 1000 G
U3.10Ues
```

Bi-Directional Mode

```
RATE 0.0000 GPM
TOT+ 0.000 G
TOT- 0.000 G
U3.10Ues
```

By pressing the Enter or E key (bottom key), you will be at the main submenu screen. If no entry is done within 5 minutes while in any of

the programming parameters, the program returns automatically to the main screen. Even during the parameter setting mode, the meter will be measuring and totalizing any flow that occurs.

```
factors
outputs/totals
>measurement
back E=End
```

There are three main submenus: factors, outputs/totals and measurement. Each submenu gives access to the following appropriate functions:

Factors:

- 1) Detector factor
- 2) Pipe diameter
- 3) Password protection

Outputs/Totals:

- 1) Reset totals
- 2) Analog outputs
- 3) Pulse outputs
- 4) Frequency
- 5) Flow alarm

Measurement:

- 1) Unit
- 2) Full scale
- 3) Low flow cutoff
- 4) Empty pipe detection
- 5) Flow direction
- 6) Filter
- 7) Error list

PROGRAMMING OF MEASUREMENT PARAMETERS

When the programming submenu screen appears, notice the right arrow on the far left side. Using the up ↑ arrow key, you can position the arrow in front of the submenu that you wish to interrogate. We recommend starting with the "measurement" submenu followed by the "outputs/totals" submenu and finally the "factors" submenu.

```
factors
outputs/totals
>measurement
back E=End
```

Use the ↑ key to position the > arrow next to "measurement" and press the → key. The following screen will appear:

UNIT OF MEASURE

```
unit
change
>next Parameter
back E=End
```

This is where you will select the unit of measurement for the flow rate indication and the totalizers. Use the ↑ key to place the → arrow next

to "change" and press → key. The first unit of measurement screen will appear:

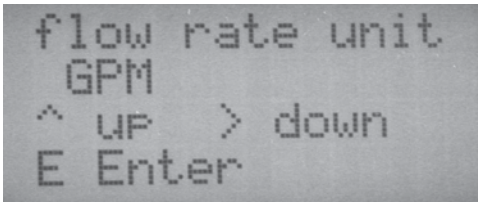

Using the ↑ or → keys, select the desired unit of measure for flow rate indication.

Choices are:

L/h	Liters/hour
L/m	Liters/minute
l/s	Liters/second
m ³ /h	Cubic meters/hour
m ³ /m	Cubic meters/minute
m ³ /s	Cubic meters/second
GPM	US gallons/minute
MGD	US million gallons/day
LbM	US liquid pounds/minute
oz	US fluid ounces/minute
IGM	Imperial gallons/minute

The existing totalizer values are automatically converted into the selected unit of measure.

After selecting unit of measure for flow rate, press Enter. You will see the following screen for selecting unit of measure for the totalizer.

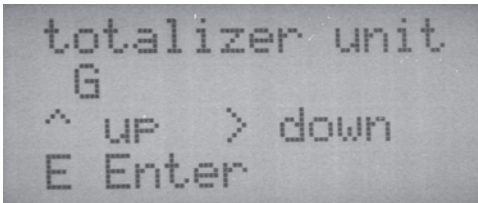

Choices are as follow; any existing values on the totalizers will automatically be converted into the new selected unit of measure

L	Liter
m ³	Cubic meter
G	US gallons
MG	US million gallons
Lb	US liquid pounds
oz	US fluid ounces
IG	Imperial gallons
aft	Acre feet
ft ³	Cubic feet

After the totalizer unit of measure selection, press the E key the following screen will appear:

FULL SCALE (MAXIMUM FLOW)

If you changed the unit of measure, the full scale or maximum flow may also need to be changed to reflect the maximum flow rate with the new unit of measure. **This is a very important parameter as it relates to other parameters including frequency output, low-flow cut-off, alarm outputs and analog signal outputs.** Adjust the desired new full scale setting based on your meter size and your

applications requirements, making sure that it falls within the suggested flow range of the meter.



When done, press enter and then the → key and the next parameter will appear.

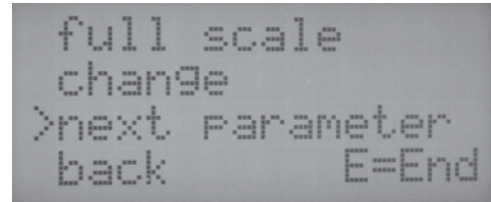

This is the same full scale parameter as previously visited. It is positioned here to provide ability to change full scale setting if no unit of measure change is necessary.

The full scale can be chosen in a range of 0.4 up to 39.4 ft/sec. A flow value is assigned to the analog output as well as the frequency output by the full scale scaling. The scaling is valid for both flow directions.

NOTE: If the flow rate is exceeding the full scale setting by more than 5%, an error is indicated that the selected full scale range is exceeded. (Terminals 7 and 8)

Once this is done, press E and then the → key and the next parameter will appear:

LOW FLOW CUTOFF

This is the low flow cutoff function. It is used to assign a low flow rate at which measurement will stop, preventing measurement and thus totalization errors. This parameter can be programmed from 0 % up to 10% of selected full scale flow rate.

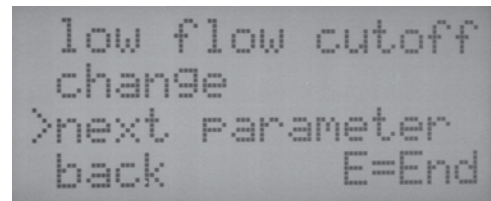

Place the > arrow next to "change" and then press the → key. The following screen will appear:

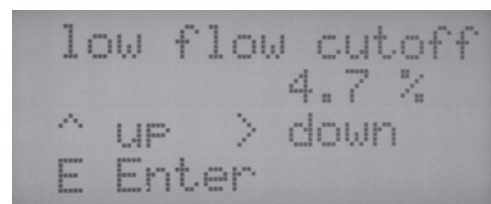

The factory setting is 0.2%. Increasing this value will help prevent false readings during "no flow" conditions due to fluid movement in the pipe caused by vibrations or piping arrangements.

Using the ↑ and → keys select a value and then press ENTER.

Press → key and you will see the next parameter:

EMPTY PIPE DETECTION

The empty pipe detection parameter when programmed to be ON will provide an error relay indication if the meter is partially filled with liquid. This will also show an empty pipe error message on the display.

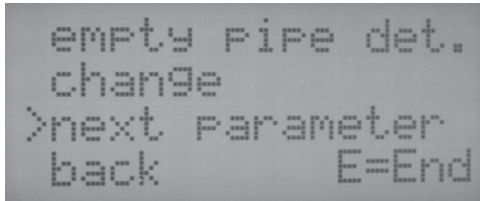

```
empty pipe det.  
change  
>next parameter  
back E=End
```

Position the > next to "change" and press the → key. The following screen will appear:

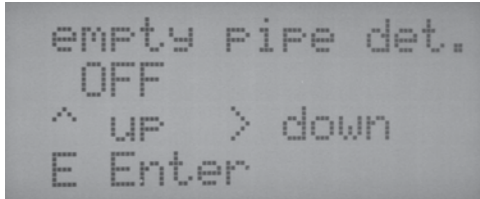

```
empty pipe det.  
OFF  
^ UP > down  
E Enter
```

NOTE: The empty pipe detection can be calibrated if required if the fluid conductivity is different than water or the remote cable length is significantly changed.

Use the ↑ and → keys to turn the feature ON or OFF as desired.

If off is selected, hit ENTER and then the →key to go to the next parameter. If ON is selected, hit ENTER and the following screen will appear:

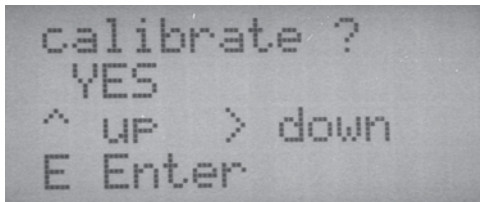

```
calibrate ?  
YES  
^ UP > down  
E Enter
```

To proceed with calibration, leave "YES" selected and hit ENTER for the next screen.

The pipe has to be filled with the media that will be measured by the meter. A value between 0 and 5000 mV will be measured and displayed. The value increases with decreasing conductivity, increasing cable length or size. For normal water, the value should be between 10mV and 500mV. Afterwards the signal difference between full and empty pipe is determined by the hysteresis value.

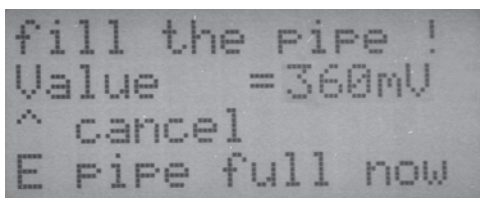

```
fill the pipe !  
Value =360mV  
^ cancel  
E pipe full now
```

Make sure your pipe is full of fluid and when ready, hit ENTER. This new screen is the hysteresis value entered. This value is set at the factory at 1000 mV to allow some variation in empty pipe detection to eliminate the potential for false "empty pipe signals." It is not necessary for this value to be changed.

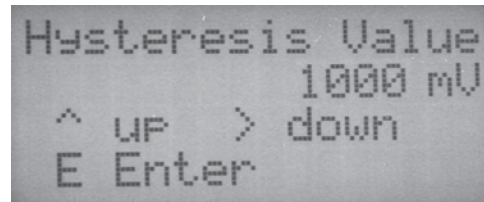

```
Hysteresis Value  
1000 mV  
^ UP > down  
E Enter
```

When calibration is complete, hit ENTER.

The switching threshold for the empty pipe detection is when the measuring signal "full pipe" plus hysteresis value is exceeded (i.e. = 360 mV+ 1000 mV). The maximum value for the switching threshold is at 4000 mV.

If full pipe calibration value is higher than 3000mV, please contact customer service for assistance.

Hit →key for next parameter screen:

FLOW DIRECTION

The flow direction can be programmed to uni- or bi-directional modes.

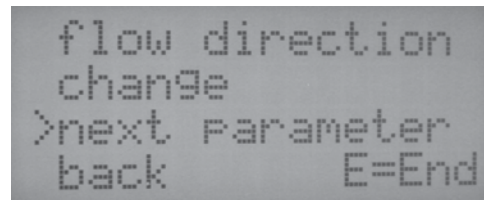

```
flow direction  
change  
>next parameter  
back E=End
```

Place the > next to "change" and press the → key. One of the following (2) screens will appear:

Uni-directional totalizes the flow only in one direction (flow direction on the detector label). If the fluid is flowing in the opposite direction, the counter will indicate zero on the display and no outputs. Both totalizers can be used as resettable counters in this mode. The totalizers are indicated as "TOT1" and "TOT2".

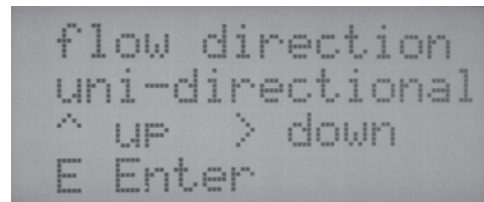

```
flow direction  
uni-directional  
^ UP > down  
E Enter
```

The bi-directional setting measures the flow in both directions. The first totalizer (TOT+) is measuring in the forward flow direction and the second totalizer (TOT-), the reverse direction. A change of flow direction is indicated via the flow direction relay.

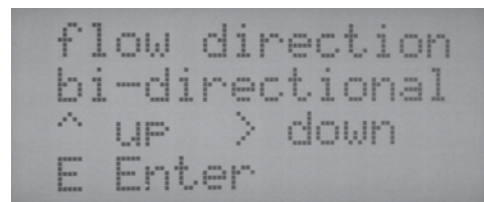

```
flow direction  
bi-directional  
^ UP > down  
E Enter
```

Relay Wiring Terminals

Flow Direction Relay

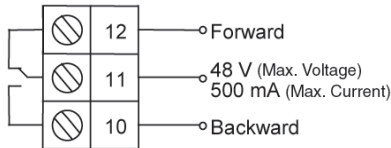

Using the ↑ and → key select which flow direction mode you want and press ENTER. Hit the → key to go to the next parameter.

FILTER DAMPENING

This feature is for dampening of all output signals and flow rate display. This function has no effect on the totalizers.

The factory setting is 1. If you notice too much back and forth oscillation of the flow rate indication, increase this value incrementally until the display is more stable. Your choices are 1 through 6 or "Inactive." To change the filter value, place the arrow next to "change" and press the → key. The following screen will show:

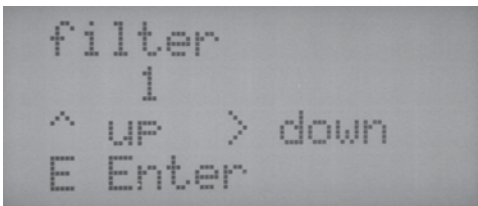
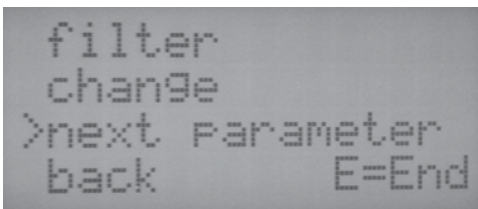

Using the ↑ and → keys select the desired filter value and then press ENTER. Hit → key to go to last parameter of this submenu.

ERROR LIST (MESSAGES)

The error list in the program menu indicates the last 8 error types that have occurred and the frequency of each. The sum of all switching on processes can be read on the "Power Up - Counter." This can assist in checking possible power failures.

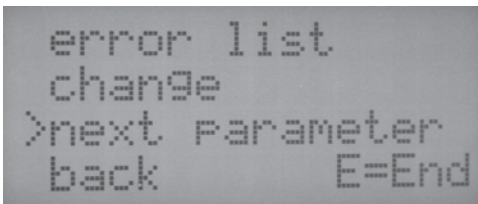

Line up the > with "change" and hit the → key. This will bring up the 1st error. Continue hitting the → key to toggle through the last 8 errors that occurred, with #1 being the most recent error and the power-up indication screens.

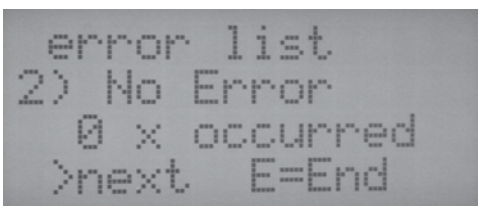

Any error is indicated via the error relay as well as displayed on line 4 of the LCD display. The relay is normally closed during normal operation and is opened when an error occurs.

Error Relay

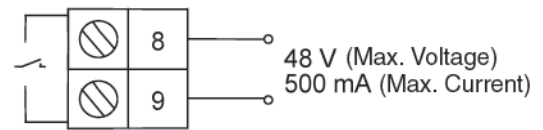

Now hit the → key again and you will be at the screen for clearing all the error list information.

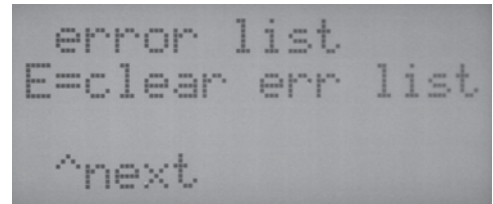

Hit Enter to clear and the following screen will appear with "Done" indication.



An overview of the possible errors and causes can be found in the Troubleshooting section.

Now hit enter twice and you will be back at the submenu screen.

PROGRAMMING OF OUTPUTS/TOTALS PARAMETERS

The next submenu is outputs/totals.

From the main submenu screen, position the > next to the "outputs/totals" submenu and press the → key.

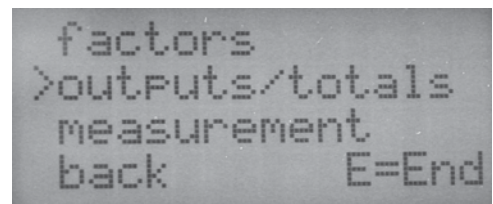

The following screen will appear:

RESETTING OF TOTALIZERS

This parameter is used to reset either of the totalizers to zero.

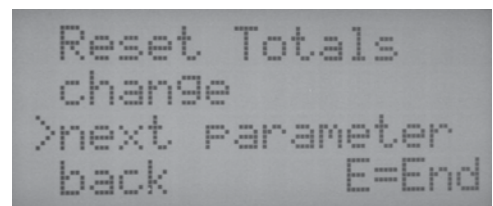

Line up the > with change and hit → key.



Now line up the > next to the totalizer you wish to reset. Hit → key and that totalizer will now indicate "DONE."



If desired to reset the other totalizer, repeat the same steps.



The "TOT2" totalizer in the uni-directional flow mode, can be reset externally.

The following is the wiring connections diagram for external reset.

External resetting

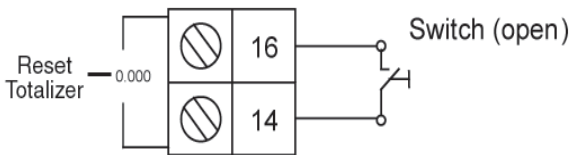

When finished, hit Enter. Hit → key to go to the next parameter.

ANALOG OUTPUTS

This parameter is for selection of the desired analog output and also calibration if required.

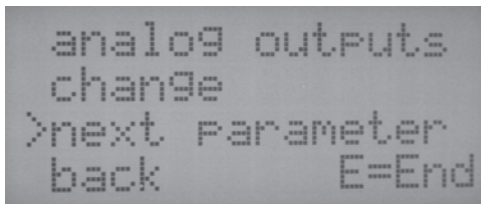

The following are the options available for the analog output ranges.

- 4 to 20 mA
- 0 to 20 mA
- 2 to 10 mA
- 0 to 10 mA

Press the →key at the "change" line the following screen will appear:

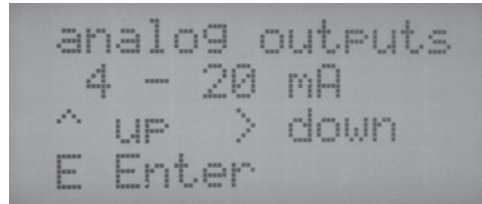

Press ↑ or → keys until you find the type of analog output that you desire among the following screens:

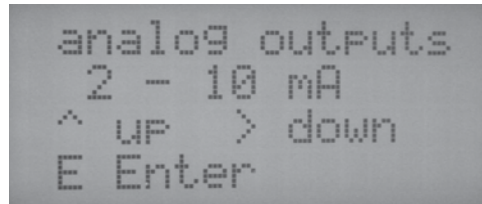
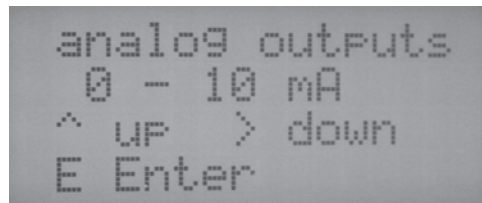
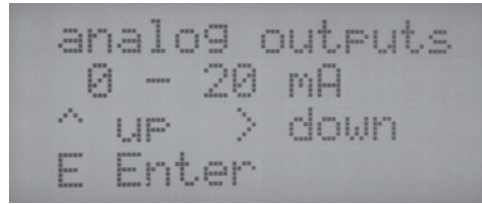

NOTE: The flow value is limited to 105% of the programmed full scale value. If this value is exceeded, an overflow error will appear on the LCD display. In bi-direction operation, the flow direction is indicated via the flow direction relay. The following diagram illustrates wire connections for the analog output signal.

Analog output (active)

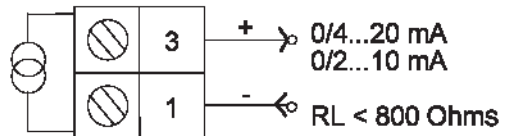

Once you have selected the output, press the ENTER key to select that particular output. You will then be at the calibration screen. You should calibrate the analog output after you have it connected to your PLC or chart recorder.

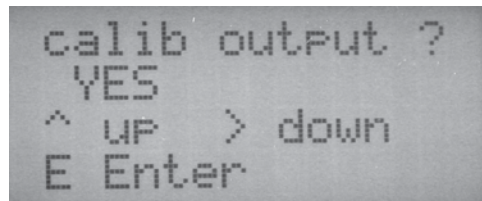

If calibration is in fact desired, hit ENTER again to get to the following screen:

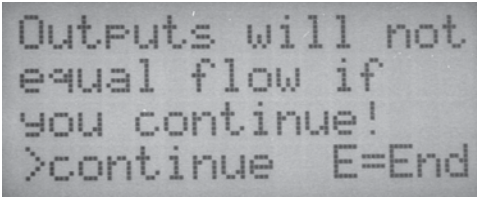

This is an important reminder to make sure that if the meter is part of a closed loop system, you must put the system in manual operation while performing the calibration process.

Hit the → key to continue and this screen will appear:

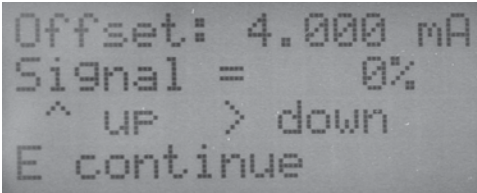

Hooking up an amp meter in series with the connected chart recorder (Terminals 1 and 3), you may use the ↑ and → keys to calibrate the 4mA signal for "0" flow. Hit ENTER to continue.

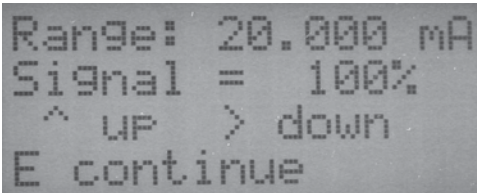

Now the 20 mA signal may be calibrated for 100% flow based on maximum flow rate set in programming.

NOTE: When you use a different analog output setting than 4-20mA, (i.e. 0-20mA) that the output calibration will still be performed with 4-20mA and applied to the selected setting (i.e. 0-20mA).

Hit ENTER to complete calibration and the → key for next parameter.

PULSE OUTPUTS

The pulse output parameter will determine how many pulses per gallon, liter, etc. will be sent out to remote counters, controllers, etc. It will also set how many decimal digits will be displayed on the totalizers. If, for example, you choose 100 pulses per gallon, then the display totalizers will have two digits after the decimal point.

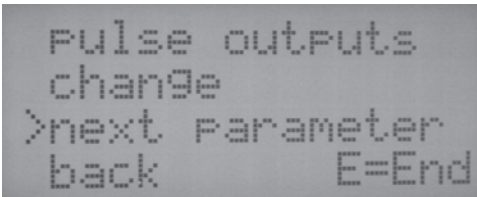

Move the > arrow next to "change", then press the → key and the following screen will appear:

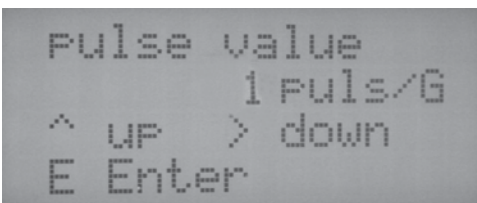

Use the ↑ and → keys to change the value to the desired pulse rate. This value may be set from .001 to 10,000 pulses/unit of measure. Maximum frequency of 10kHz can not be exceeded. Based on maximum flow rate setting, the program will not permit a value that exceeds this frequency.

Press ENTER when you have programmed the desired number.

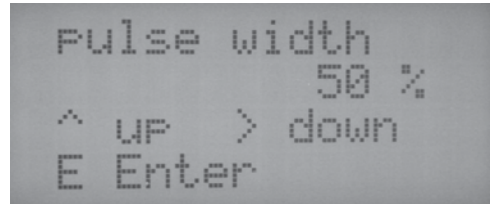

This parameter is pulse width, or the time duration that each pulse will be "ON". The 50% setting means 50% on 50% off. You can set the width in increments of 5 ms from 5-500 ms. The factory setting is 20 ms. Program this parameter to match the required pulse width of the remote accessory that will receive the pulse output. For output to any AMR device, see steps below.

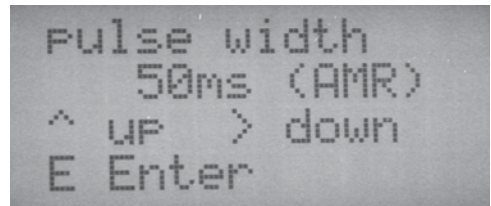

Hit enter and the next screen is:

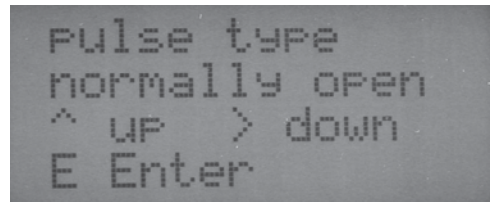

This parameter permits changing of the factory setting of "Normally Open" for the pulse output to "Normally Closed." After complete, hit enter and the → key for the next parameter.

WIRING OF AMR UNIT TO MAG METER

AMR Wiring Diagram

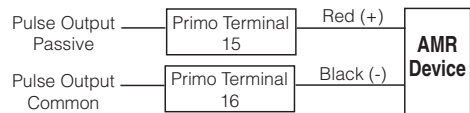

Step 1: Check to make sure your pulse output settings are correct per chart.

Maximum Flow Rate	Pulse Output Setting
Less than 5500 gpm	1 pulse per 100 or 1000 gallons
Greater than 5500 gpm	1 pulse per 1000 gallons
Less than 5500 Cu. Ft./min.	1 pulse per 100 or 1000 Cu. Ft.
Greater than 5500 Cu. Ft./min.	1 pulse per 1000 Cu. Ft.

Step 2: Set pulse width to "50 ms (AMR)"

Step 3: Set pulse type to "normally open"

The following diagram is for other wiring connections for pulse outputs.

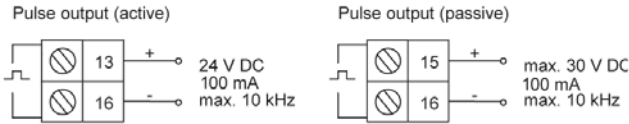

FREQUENCY OUTPUT

This is the Frequency Output parameter. The setting can range from 500 Hz up to 5000 Hz for the Full Scale Value. (Example: If 1600 Hz is selected, then when meter display indicates full scale value, this output is equal to 1600 Hz).

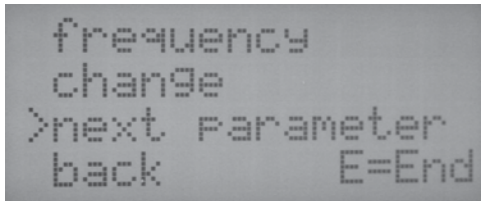

If a change is desired, line up > cursor with change and hit → key.

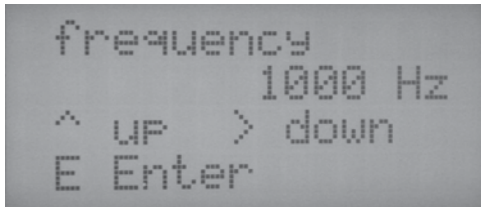

When complete, hit Enter.

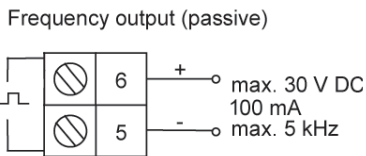

Hit → key for next parameter.

FLOW ALARMS

This parameter allows the setting of a minimum and maximum percentage (%) of the Full Scale flow rate value. Settings can be made in 1% increments from 0 to 100%. The minimum value must be smaller than the maximum value.

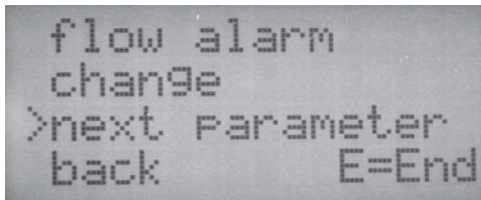

Move the > next to "change" and press the → key. The following screen will appear:

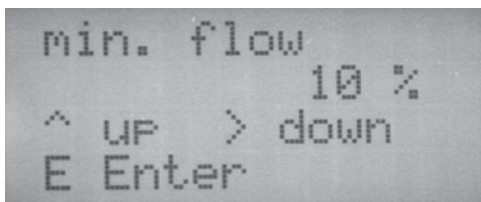

Use the ↑ and → keys to select the minimum flow percentage and press ENTER; the following screen will appear:

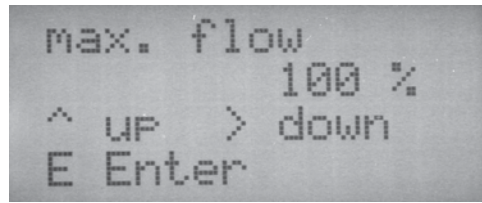

Use the ↑ and → arrows to change the maximum flow percentage and press ENTER.

NOTE: On the signal output, the relays will remain energized until the flow rate returns to within the flow limits.

Flow Alarm Relay

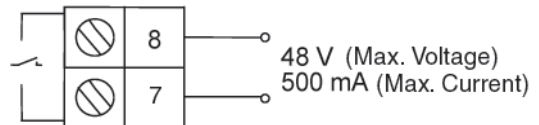

Press ENTER again to return to submenu screen.

PROGRAMMING OF FACTORS PARAMETERS

The third and last submenu "Factors" contains parameters that usually do not require changes.

Press ENTER until you reach the submenu screen if not already there.

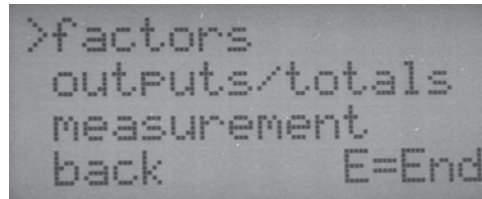

Position the > next to the "factors" submenu and press the → key. The following screen will appear:

DETECTOR FACTOR (FIELD CALIBRATION)

This is the Detector factor setting. When the meter was calibrated, this value was programmed in this parameter as a result of that calibration. Each detector has its individual factor. This detector factor is also included on the label of the meter body.

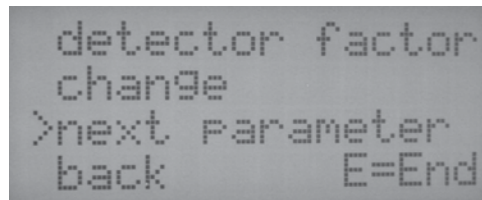

Line up the > with "change" and hit → key. This is the detector factor setting.

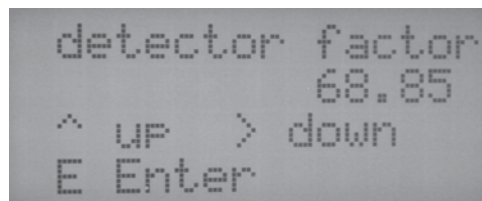

With this parameter, you can fine tune your calibration to meet your applications needs. If you find that the meter is off by a certain percentage, you can modify the detector factor to achieve the desired accuracy.

Even though all meters are calibrated at the factory, sometimes your specific installation and fluid parameters make it necessary to recalibrate a meter under actual operating conditions with the liquid being metered.

The following instructions are provided to assist in performing an on-site calibration check and adjustment. This procedure may require either a test tank or vessel of known capacity or a second flow meter installed in the same line.

ACCURACY TEST

1. Place a test tank of calibrated volume at the output of the meter.
2. Operate meter until test tank is filled to the appropriate calibrated level. Since meter accuracy can vary somewhat with flow rate, we recommend making test run at the same flow rate used in actual operation.
3. Record quantity indicated on display totalizer.
4. Repeat run three times and calculate an average for the (4) tests.
5. Perform the following calculation to determine the percent of accuracy of the meter.

$$\frac{\text{Qty. Delivered in vessel}}{\text{Average Meter Reading}} \times \text{Old Detector Factor} = \text{New Detector Factor}$$

Example 1.

$$\frac{100 \text{ Gallons}}{95 \text{ Gallons}} \times 68.85 = 72.47$$

In this example, the meter accuracy is low and must be increased by a calibration correction.

Example 2.

$$\frac{100 \text{ Gallons}}{104 \text{ Gallons}} \times 68.85 = 66.20$$

In this example, the meter accuracy is high by 4% and must be reduced by a calibration correction.

When finished with detector factor parameter, hit ENTER and then hit → key to go to the next parameter.

METER/PIPE SIZE

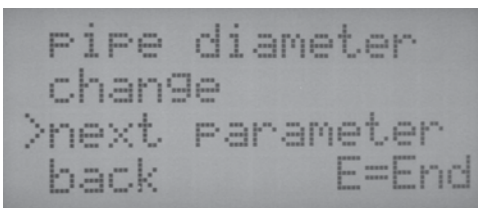

Place the arrow next to "change" and press the → key. The following screen will show:

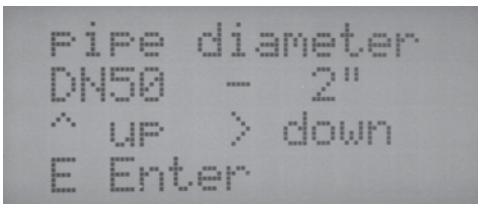

This parameter will come preprogrammed from the factory matching the line size of the detector. However, if you replace the entire amplifier in the field, you may need to reprogram this parameter.

Select the pipe diameter of your flow meter by using the ↑ and → keys to match your meter size.

When complete, press Enter.

Hit → key to go to the next parameter.

PASSWORD PROTECTION

This is the password protection parameter. The unit will be set at "0" (no password required) from the factory. If activated, whenever you want to go into any of the submenus, the unit will ask for the password number.

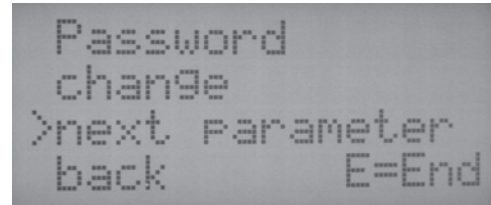

To activate the password, line up the > with "change" and hit → key.

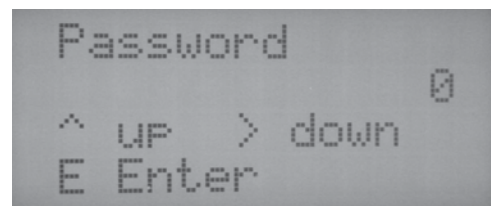

Change "0" to any desired number from 1 to 999. Hit enter and after returning to the main screen, you will always have to enter the new password to get into the submenu. If the password is lost or forgotten, a factory "333" password value can also be used to satisfy the password entry. If later no password is desired, change the value back to "0", hit Enter and a password will no longer be required to enter any of the submenus.

Hit ENTER twice and you will be back at the main screen.

LANGUAGE SELECTION

The software permits the selection of English or Spanish languages. To change the language, switch off power to Primo Amplifier. While holding the ENTER key down, re-power the unit. Hit ENTER to get to the following screen:

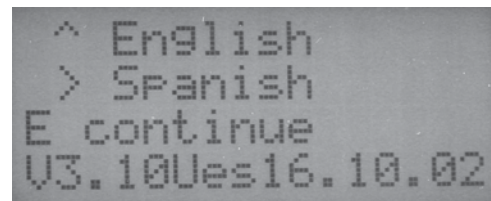

Select desired language and hit ENTER several times until main menu screen appears.

TROUBLESHOOTING

The Magnetoflow® mag meter should give you many years of maintenance free operation. However, should it malfunction, there are certain things that we recommend you check before contacting our technical support department or your local Badger® Representative.

Note: If the fluid measured has a high concentration of conductive solids, deposits may accumulate on the internal liner walls and electrodes. These deposits will cause a reduction of the measuring output. Thus, it is recommended to remove the meter and inspect the liner and electrodes after 6 months. If deposits are found, remove them with a soft brush. Repeat inspection process every 6 months or until an appropriate inspection cycle, (likely longer) can be established for the specific application. Some general conditions as follows:

DESCRIPTION	POSSIBLE CAUSE	RECOMMENDED ACTION
Flow is present but display is "0"	Signal cable not connected.	Check signal cable.
	Detector mounted opposite of the main flow direction (see arrow on the nameplate).	Turn detector by 180° or switch terminal 45 and 46 or reprogram to bidirectional mode.
	Coil or electrode cables exchanged.	Check cable connections for cross wiring.
Inaccurate measuring	Parameter wrong.	Check the parameters (transmitter, detector factor and size) according to attached data sheet.
	Pipe not fully filled.	Check if meter is fully filled.
No display	No power.	Apply power.
	Incorrect power.	Check power value.
	Wiring connections.	Check power input/output connections.
	Fuse blown.	Replace fuse. (2 Amp slow blow 5 x 20 mm)
Flow rate value known to be wrong	Maximum flow rate setting.	Change setting.
	Detector Factor.	Check value on label.
	Deposits on electrodes and/or liner.	Check and remove deposits.
	Incorrect pipe size programmed.	Check size if necessary.
Flow rate indication unstable	Filter value too low.	Increase filter value setting.
	Cable issue.	Make sure cable is shielded and not vibrating.
	Grounding issue.	Make sure meter is properly grounded to a good earth ground.
	Partially full pipe.	Make sure pipe is full of fluid.
	Air.	Make sure fluid does not contain air bubbles.
	Amplifier location - outside electrical interference.	Make sure amplifier is not too close to sources of electrical interference.
	Chemical injections.	Check location of injection in relation to location of meter.

ERROR MESSAGE EXPLANATION

Some general conditions to keep in mind: When certain connections are sensed by the electronics, the following error messages can be indicated on the display (line 4) as well as on relay 3. The relay is closed during normal operation and is opened by an error appearing.

The following error messages can appear:

ERROR MESSAGE	POSSIBLE CAUSE	RECOMMENDED ACTION
Err: Detector	No detector connection with amplifier.	Check detector and cable connections in accordance with Instruction Manual.
	Connection between amplifier and detector interrupted.	Contact Technical Support.
	Supply voltage too low.	Contact Technical Support.
	Grounded coils in meter.	Contact Technical Support.
	Water in detector.	Contact Technical Support.
Err: Output	Micro processor output control defective.	Contact Technical Support.
Err: unknown	Program error.	Contact Technical Support.
Err: empty pipe	Pipe may not be full.	Make sure all trapped air is out of system.
		If fluid or fluid conductivity recalibrate the parameter.
Err: full scale	Actual flow rate is exceeding the programmed full scale value by more than 5%.	Reduce flow rate or increase the programmed full scale value.
Err: AD-Range	AD-Converter is exceeding signal limits.	Check the grounding scheme of the meter installation. See grounding section in manual.
Err: AD-Init	Initialization of AD-Converter unsuccessful.	Contact Technical Support.

If additional assistance is required, please contact our **TECHNICAL SUPPORT department at 1-800-456-5023** or contact your local Badger® Representative.

COMPLETE BOARD ASSEMBLY REPLACEMENT

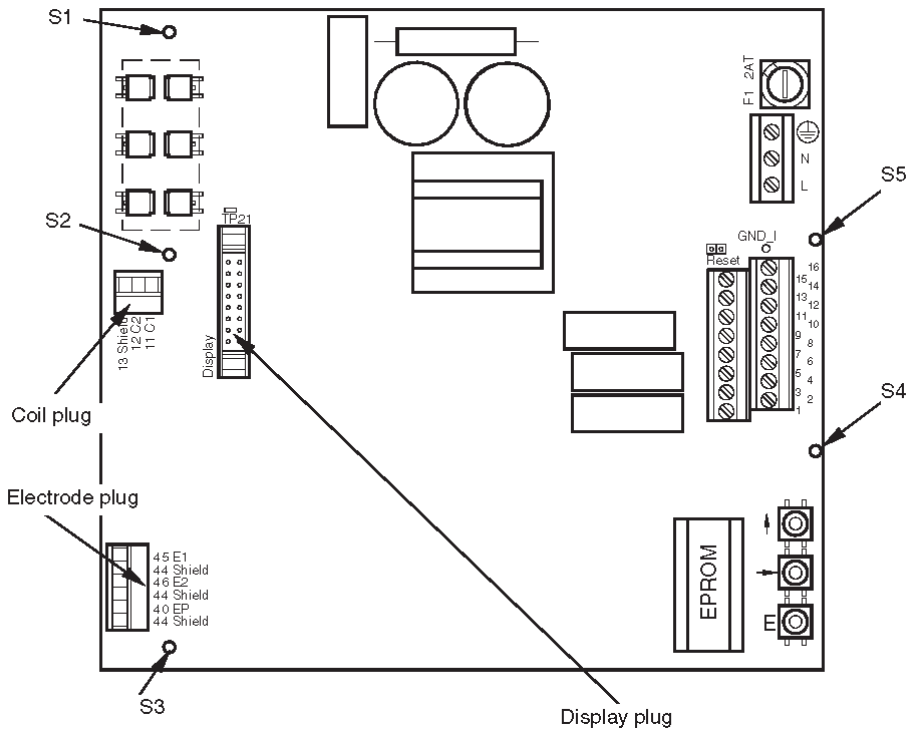

⚠ WARNING

Make sure power to Primo® amplifier is off before proceeding.

1. Pull the electrode, coil and display wiring plugs. Loosen the screws S1 to S5 and remove the existing board assembly.
2. Put in new board assembly and reassemble screws to S1 and S5. Reinstall the (3) wiring plugs.
3. Program the new board assembly with the previous detector factor and meter size.

FUSE REPLACEMENT

⚠ WARNING

Make sure power to Primo amplifier is off before proceeding.

Fuse type: 250 V, 2 A (time-lag)

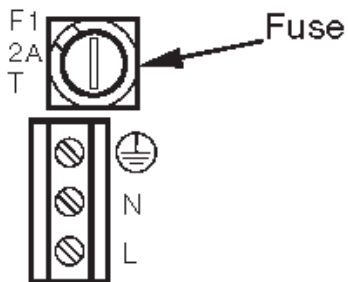

(This page intentionally left blank.)

Please see our website at
www.badgermeter.com
for specific contacts.

Copyright©Badger Meter, Inc. 2009. All rights reserved.

Due to continuous research, product improvements and enhancements, Badger Meter reserves the right to change product or system specifications without notice, except to the extent an outstanding bid obligation exists.



®

BadgerMeter, Inc.

P.O. Box 245036, Milwaukee, WI 53224-9536

Telephone: (414) 355-0400 / (800) 456-5023

Fax: (414) 355-7499 / (866) 613-9305

www.badgermeter.com