

Autonics

SWITCHING POWER SUPPLY SP SERIES

M A N U A L



Thank you very much for selecting Autonics products.
For your safety, please read the following before using.

Caution for your safety

※ Please keep these instructions and review them before using this unit.

※ Please observe the cautions that follow;

Warning Serious injury may result if instructions are not followed.

Caution Product may be damaged, or injury may result if instructions are not followed.

※ The following is an explanation of the symbols used in the operation manual.

Caution: Injury or danger may occur under special conditions.

Warning

1. In case of using this unit with machineries (Nuclear power control, medical equipment, vehicle, train, airplane, combustion apparatus, entertainment or safety device etc), it requires installing fail-safe device, or contact us for information on type required.

It may result in serious damage, fire or human injury.

2. This unit must be mounted on panel.

It may give an electric shock.

3. Do not connect terminals when it is power on.

It may give an electric shock.

4. Do not repair or check up when power on.

It may give an electric shock.

Caution

1. This unit shall not be used outdoors.

It might shorten the life cycle of the product or give an electric shock.

2. When wire connection, No.20AWG(0.50mm²) should be used and screw bolt on terminal block with 0.74N·m to 0.90N·m strength.

It may result in malfunction or fire due to contact failure.

3. Please observe specification rating.

It might shorten the life cycle of the product and cause a fire.

4. In cleaning the unit, do not use water or an organic solvents.

It might cause an electric shock or fire that will result in damage to this product.

5. Do not use this unit at place where there are flammable or explosive gas, humidity, direct ray of the sun, radiant heat, vibration, impact etc.

It may cause explosion.

6. Do not inflow dust or wire dregs into inside of this unit.

It may cause a fire or mechanical trouble.

Ordering information

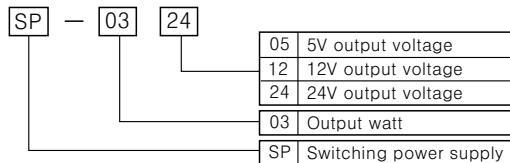

※ The above specification are changeable without notice anytime.

Dimension

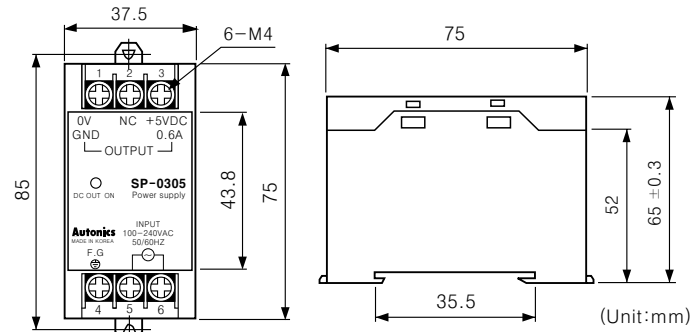

Specification

Model	Switching power supply		
	SP-0305	SP-0312	SP-0324
Output voltage	5VDC	12VDC	24VDC
Allowable output voltage range	95 to 105%		
Output watt	3W		
Efficiency	67 to 74%		
Power supply	100-240VAC 50/60Hz		
Input current	Max. 0.15A		
Output ripple voltage	Max. 5%(P-P) of output voltage		
Output voltage regulation	Max. 0.5%		
Insulation resistance	Min. 100MΩ (at 500VDC)		
Dielectric strength	2000VAC 50/60Hz for 1 minute		
Vibration	Mechanical	0.75mm amplitude at frequency of 10 to 55Hz in each of X, Y, Z directions for 2 hour	
	Malfunction	0.5mm amplitude at frequency of 10 to 55Hz in each of X, Y, Z directions for 10 minutes	
Shock	Mechanical	300m/s ² (Approx. 30G) 3 times at X, Y, Z direction	
	Malfunction	100m/s ² (Approx. 10G) 3 times at X, Y, Z direction	
Display	Red LED		
Ambient temperature	-10 to 50°C (at non-freezing status)		
Storage temperature	-20 to 70°C (at non-freezing status)□		
Ambient humidity	35 to 85%RH		
Weight	Approx. 100g		

Mounting on the DIN rail

● To mount the power supply on the DIN rail

Firstly hook the part (a) of the power supply on the DIN rail and then press the power supply in the direction (b).

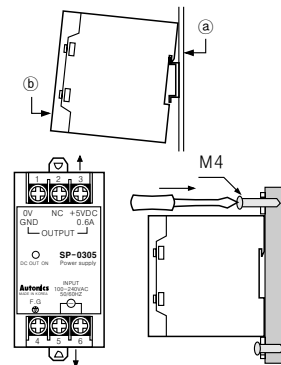

● To remove the power supply from the rail

Insert the tip of a screwdriver into part (c) and push the screwdriver downward.

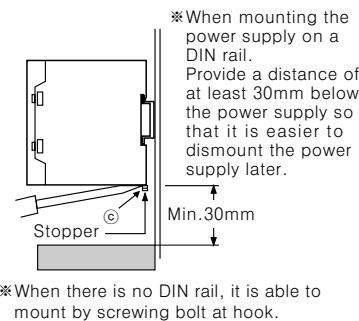

Parts name

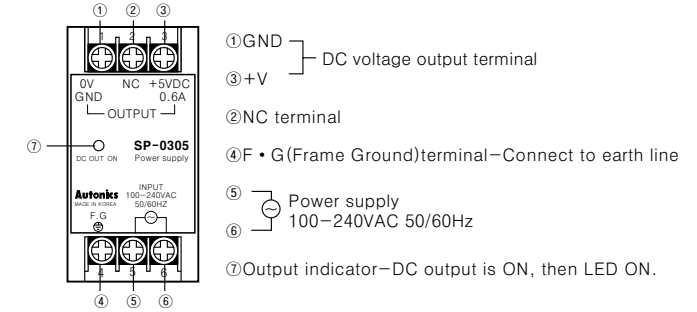

Caution for using

1. How to use

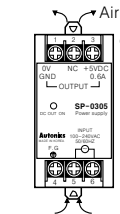

● Install the power supply so that heat is effectively dissipated to extend the life expectancy and improve the reliability of the power supply.

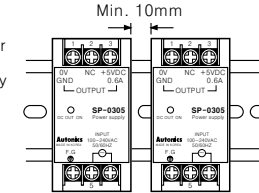

● When installing two or more power supplies side by side. Provide a distance at least 10mm as shown below between the power supplies to dissipate heat effectively.

2. Input terminal (Be careful to connect AC power)

Wire input line to input terminals properly, if wrong wiring to the other terminals, the unit will be damaged.

3. Parallel and serial

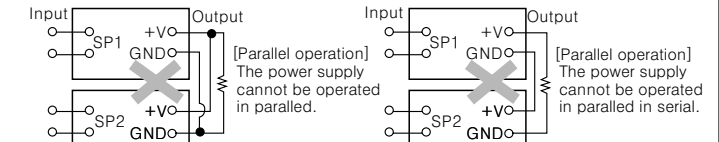

4. When test dielectric voltage and insulation resistance of the control panel with this unit installed.

① Please isolate this unit from the circuit of control panel.

② Please make all terminals of this unit short-circuited.

5. Do not use this unit at below places.

① Place where there are severe vibration or impact.

② Place where strong alkalis or acids are used.

③ Place where there are direct ray of the sun

④ Place where strong magnetic field or electric noise are generated.

6. Installation environment

① It shall be used indoor

② Altitude Max. 2000m

③ Pollution Degree 2

④ Installation Category II

※ It may cause malfunction if above instructions are not followed.

Main products

- COUNTER
- TIMER
- TEMPERATURE CONTROLLER
- PANEL METER
- TACHOMETER
- LINE SPEED METER
- DISPLAY UNIT
- PROXIMITY SWITCH
- PHOTOELECTRIC SENSOR
- FIBER OPTIC SENSOR
- PRESSURE SENSOR
- ROTARY ENCODER
- SENSOR CONTROLLER
- POWER CONTROLLER
- STEPPING MOTOR & DRIVER & CONTROLLER

Autonics Corporation
<http://www.autonics.net>

■ HEAD QUARTER :
41-5, Yongdang-Ri, Ungsang-Up, Yangsan-Shi, Kyung-Nam, Korea 626-847.

■ TRADE DEPARTMENT :
511 Ansung B/D, 410-13, Shindolim-Dong, Kuro-Gu, Seoul, Korea 152-070
TEL: 82-2-679-6585 / FAX: 82-2-679-6556
■ E-mail : sales@autonics.net