

AutoRAE 2

Automatic Test and Calibration System

User's Guide



Product Registration

Register your product online by visiting:

www.raesystems.com/support/product-registration

By registering your product, you can:

- Receive notification of product upgrades or enhancements
- Be alerted to Training classes in your area
- Take advantage of RAE Systems special offers and promotions

AutoRAE 2 User's Guide

Contents

Read Before Operating	4
1. AutoRAE 2 Automatic Test and Calibration System - General Information	5
2. Specifications.....	7
3. Overview.....	9
3.1. Standard Package Contents.....	15
4. Installing End Caps For Stand-Alone Use.....	16
5. Powering The AutoRAE 2 Cradle	17
6. Preparing For Bump Testing & Calibration	18
6.1. Installing An External Filter	18
6.2. Installing An External Charcoal Filter.....	18
6.3. Connecting An AC Adapter.....	19
6.4. Connecting Calibration Gas.....	20
6.5. Placing A MultiRAE Monitor In The Cradle	22
6.6. Placing A ToxiRAE Pro Monitor In The Cradle	23
6.6.1. Installing Adapters In The ToxiRAE Pro Cradle.....	23
6.6.2. Placing A ToxiRAE Pro Monitor In The Cradle	24
6.7. Placing A QRAE 3 Monitor In The Cradle	25
6.8. Placing A Handheld PID Monitor In The Cradle	27
6.8.1. Installing A Quick Connector	27
6.8.2. Installing The Instrument In the Cradle	28
6.9. Warm-Up.....	29
7. Performing A Bump Test.....	30
8. Performing A Calibration	31
9. Bump And Cal Error And Status Messages.....	32
10. Charging An Instrument's Battery.....	34
11. Removing An Instrument From A Cradle	34
11.1. AutoRAE 2 Reports.....	35
12. Programming A Stand-Alone AutoRAE 2 Cradle.....	37
12.1. Gas Inlet Configuration Settings	40
12.2. Selectable Gas Index Values For Gas Config 8.....	43
12.3. Gas Name	43
12.4. Concentration [Value]	44
12.5. Concentration Unit.....	44
12.6. Purge Time (Sec.).....	44
12.7. Soak Time (Sec.)	44
12.8. Uploading Settings To The AutoRAE 2 Cradle	45
12.9. Downloading & Uploading Individual Gas Inlet Settings	45
12.10. Saving The Settings File.....	45
12.11. Recalling Stored Settings	46
12.12. Uploading Settings To Multiple AutoRAE 2 Cradles	46
12.13. Exiting Programming	46
13. Upgrading Firmware On The AutoRAE 2 Cradle	47
14. Using A Stand-Alone AutoRAE 2 Cradle For Datalog Transfer, Monitor Configuration, and Firmware Upgrades	50
15. Overview.....	51
15.1. Standard Package Contents.....	52
16. Operation of an AutoRAE 2 Controller-based System.....	53
17. Setting Up an AutoRAE 2 Controller-based System.....	54
17.1. Installing Batteries For The Real-Time Clock.....	55

AutoRAE 2 User's Guide

17.2. Attaching An External Filter	56
17.2.1. Active Carbon Filter For Removing VOC	56
18. Powering an AutoRAE 2 Controller-Based System	57
19. Operating A Controller And Attached Cradles.....	58
19.1. Turning The AutoRAE 2 Controller On	58
19.2. Turning The AutoRAE 2 Controller Off	58
19.3. Startup Routine	58
19.4. User Interface	60
19.5. Display Status Messages and Color Coding	61
19.6. Warm-Up	61
19.7. Testing	62
19.7.1. Compatibility Testing	62
20. Preparing For Bump Testing & Calibration	64
20.1. SD Memory Card.....	64
20.1.1. Installing An SD Card.....	66
20.1.2. Removing An SD Card	66
20.2. Connecting Calibration Gas.....	67
20.3. Placing Monitors In Cradles	68
20.4. Performing A Bump Test.....	68
20.4.1. Interrupting A Bump Test	72
20.5. Performing Calibration	75
20.5.1. Interrupting A Calibration.....	77
20.6. Direct Bump Testing And Calibrating Via The Cradles' Buttons	79
20.7. Configuration Settings	81
20.8. Settings	82
20.8.1. Gas Settings.....	85
20.8.2. System Settings	86
20.8.3. Network Settings.....	87
21. Programming An AutoRAE 2 Controller-based System on the Computer	89
21.1. Gas Inlet Settings	94
21.2. Configuring A Gas Inlet	94
21.2.1. Gas Number	94
21.2.2. Gas Lot Number	95
21.2.3. Expiration Date	95
21.2.4. Gas Index	95
21.2.5. Gas Name	95
21.2.6. Concentration [Value].....	95
21.2.7. Concentration Unit	96
21.2.8. Purge Time (Sec.)	96
21.2.9. Soak Time (Sec.).....	96
21.3. Uploading Settings To The AutoRAE 2	97
21.4. Downloading & Uploading Individual Gas Bottle Settings	97
21.5. Saving The Settings File	97
21.6. Recalling Stored Settings.....	98
21.7. Uploading Settings To Multiple AutoRAE 2 Systems	98
21.8. Exiting Programming.....	98
22. Updating Firmware On The AutoRAE 2 Controller.....	99
23. Transferring AutoRAE 2 Controller Data To A Computer	103
23.1. Exporting Reports.....	108
23.2. Saving A Configuration Upon Exit	109
24. Wireless Operation	110

AutoRAE 2 User's Guide

24.1. Part One: Configure The AutoRAE 2 Network Interface.....	110
24.2. Part Two: Configure The WiFi Adapter & Test The Network.....	111
25. Wall Mounting A Controller & Cradles	116
26. Transferring Bump And Calibration Data	117
27. Maintenance.....	117
28. Technical Support.....	118
29. RAE Systems Contacts	118

WARNINGS

Read Before Operating

This manual must be carefully read by all individuals who have or will have the responsibility of using, maintaining, or servicing this product. The product will perform as designed only if it is used, maintained, and serviced in accordance with the manufacturer's instructions.

Proper Product Disposal At End Of Life



The Waste Electrical and Electronic Equipment (WEEE) directive (2002/96/EC) is intended to promote recycling of electrical and electronic equipment and their components at end of life. This symbol (crossed-out wheeled bin) indicates separate collection of waste electrical and electronic equipment in the EU countries. This product may contain one or more Nickel-metal hydride (NiMH), Lithium-ion, or Alkaline batteries. Specific battery information is given in this user guide. Batteries must be recycled or disposed of properly.

At the end of its life, this product must undergo separate collection and recycling from general or household waste. Please use the return and collection system available in your country for the disposal of this product.

Sensor Specifications, Cross-Sensitivities, And Calibration Information

The AutoRAE 2 can be used to calibrate a wide variety of sensors. For calibration information and specifications and cross-sensitivities of various sensors refer to RAE Systems Technical Note TN-114: Sensor Specifications And Cross-Sensitivities (available for free download from www.raesystems.com). All specifications presented in this Technical Note reflect the performance of standalone sensors. Actual sensor characteristics may differ when the sensor is installed in different instruments. As sensor performance may change over time, specifications provided are for brand-new sensors.

Make Sure Firmware Is Up To Date

For best operation, make sure your monitors, AutoRAE 2 Controller and AutoRAE 2 Cradles are running the latest firmware.

1. Controller firmware.
2. Cradle firmware.
3. Instrument firmware.

1. AutoRAE 2 Automatic Test and Calibration System - General Information

The AutoRAE 2 Automatic Test and Calibration System for new RAE Systems portable gas monitors makes compliance with monitor test and calibration requirements as easy as pressing a button. Simply cradle the monitor and the system will take care of all calibration, testing, and recharging.

The AutoRAE 2 is a flexible, modular system that can be configured to meet your calibration requirements effectively and efficiently. An AutoRAE 2 system can be as simple as a single cradle deployed in standalone mode to calibrate one instrument at a time, or as powerful as a networked¹, controller-based system supporting ten monitors and five distinct calibration gas cylinders.

Key Features

- Automatic testing, calibration, charging, and reports management
- Deployable as a standalone cradle or a controller-based system with up to 10 cradles
- Controller with a large, color LCD display
- Up to 5 calibration gas cylinders can be connected at the same time*
- Data storage on a standard SD card²
- Bench-top or wall-mounted use
- Instruments supported: MultiRAE Lite (Pumped), MultiRAE, and MultiRAE Pro, MicroRAE, ToxiRAE Pro, ToxiRAE Pro PID, ToxiRAE Pro LEL, and ToxiRAE Pro CO₂, QRAE 3 (pumped and diffusion models), and MiniRAE Lite, MiniRAE 3000, ppbRAE 3000, and UltraRAE 3000
- Unique cradle for all ToxiRAE Pro family (cradle supplied with adapters)
- Networking capability (optional)
- Wireless networking capability using external Wi-Fi module for AutoRAE 2 (optional)

Benefits

- Easy, one-touch bump testing, calibration, charging, and reports management
- Supports a wide variety of gases, including exotics
- Optimized for field use—does not require a computer to operate
- Firmware-upgradeable to protect your investment

* Supported only on AutoRAE 2 Controller-based systems

AutoRAE 2 User's Guide

Summary Of Differences Between An AutoRAE 2 Controller-Based System And A Stand-alone Cradle

	Controller-Based System	Standalone Cradle
Monitors calibrated simultaneously	Up to 10	1
Number of gas inlets (distinct calibration gas cylinders)	5 dedicated gas inlets plus fresh air with dedicated exhaust port on the Controller	2 dedicated gas inlets plus fresh air with dedicated exhaust port
Display	5.7" TFT (320 x 240) graphical backlit color LCD on the Controller + 2 seven-segment LED displays on each Cradle	2 seven-segment LED displays
Buttons	3 buttons ([Mode], [Y/+], and [N/-]) on the Controller + 2 buttons ([Bump] and [Cal]) on each Cradle	2 buttons ([Bump] and [Cal])
Power supply	<ul style="list-style-type: none"> • 12V, 7.5A output • Charges up to 10 instruments at a time 	<ul style="list-style-type: none"> • 12V, 1.25A output • Charges one instrument at a time
Printer support		Direct printing on Serial (RS-232) printers
Printing		Automatic
Built-in pump	Built-in pump (500 ml/min) in the Controller	MultiRAE Cradle relies on MultiRAE's pump to pull in air. ToxiRAE Pro Cradle has 300cc/min internal pump AutoRAE Cradle For Handheld PID relies on the instrument's pump to pull in air.
Data storage	Standard 2 GB SD card with security lock on the Controller	None. Data stored only on the PC
Networking	RJ-45 10/100 Base-T port on the Controller Wireless connectivity via external WiFi adapter	None

AutoRAE 2 User's Guide

2. Specifications

Size	
AutoRAE 2 Controller	5.63" W x 10.43" L x 1.73" H (143 x 265 x 44 mm)
MultiRAE Cradle	6.50" W x 12.68" L x 4.37" H (165 x 322 x 111 mm)
ToxiRAE Pro Cradle	6.50" W x 11.61" L x 3.91" H (165 x 295 x 99 mm)
QRAE 3 Cradle	6.50" W x 12.60" L x 4.65" H (165 x 320 x 118 mm)
Handheld PID Cradle	6.50" W x 16.80" L x 4.43" H (165 x 427 x 112.6 mm)
Handheld PID Cradle extended for UltraRAE 3000	6.50" W x 20.31" L x 4.43" H (165 x 516 x 112.6 mm)
MicroRAE Cradle	6.5" W x 11" L x 3.93" H (165 x 180 x 100 mm)
Terminal Adapter	2.17" W x 8.86" L x 1.65" H (55 x 225 x 42 mm)

Weight	
AutoRAE 2 Controller	1.9 lbs. (0.86 kg)
MultiRAE Cradle	1.9 lbs. (0.86 kg)
ToxiRAE Pro Cradle	1.96 lbs. (0.89 kg)
QRAE 3 Cradle	2.16 lbs. (0.98 kg)
Handheld PID Cradle	2.79 lbs. (1.27 kg)
MicroRAE Cradle	1.9 lbs. (0.86 kg)
Terminal Adapter	0.33 lbs. (0.15 kg)

Power Supply	
AutoRAE 2 Controller:	AC adapter (110V to 240V input, 12V, 7.5A output) Charges up to 10 instruments at a time
Cradle:	AC adapter (110V to 240V input, 12V, 1.25A output) Charges one instrument at a time

Cradles Supported	
AutoRAE 2 Controller	Up to 10 cradles total (any mix)
Cradle	No additional cradles supported

Display	
AutoRAE 2 Controller	5.7" TFT (320 x 240) graphical backlit color LCD
Cradle	2 seven-segment LEDs

Buttons	
AutoRAE 2 Controller	3 buttons ([Mode], [Y/+], and [N/-])
Cradle	2 buttons ([Bump] and [Cal])

Real-time Clock	
AutoRAE 2 Controller	Yes
Cradle	Yes

Visible Alarm/ Indicators	
AutoRAE 2 Controller	Color graphical LCD display
Cradle	Tri-color (red/green/yellow) LED lights

Audible Alarm	
AutoRAE 2 Controller	90dB @ 12" (30 cm)
Cradle	Same as above

AutoRAE 2 User's Guide

Specifications

continued

Gas Inlet/Outlet Ports	
AutoRAE 2 Controller	6 inlets (1 dedicated fresh air inlet and 5 configurable calibration gas inlets); 1 exhaust port
Cradle	3 inlets (1 dedicated fresh air inlet and 2 configurable calibration gas inlets); 1 exhaust port

Gas Port Connectors	
AutoRAE 2 Controller	Connectors with 200-series barbs, 1/8" (3.18 mm) ID tubing
Cradle:	Same as above

Gas Regulator	
AutoRAE 2 Controller	Demand-flow regulator (0 to 1,000 psig/70 bar)
Cradle	Same as above

Pump Flow Rate	
AutoRAE 2 Controller	Built-in pump (500 ml/min)
MultiRAE Cradle	None; relies on instrument's pump to pull in air
ToxiRAE Pro Cradle	400cc/min pump (typical)
QRAE 3 Cradle	400cc/min pump (typical)
Handheld PID Cradle	None; relies on instrument's pump to pull in air

Data Storage	
AutoRAE 2 Controller	Standard 2 GB SD card with security lock
Cradle	None. Data stored only on PC

PC Communications	
AutoRAE 2 Controller	USB (Type B) port for direct connection to PC
Cradle	Same as above

AUTORAE 2 CRADLE

3. Overview

An AutoRAE 2 Cradle can be deployed as a stand-alone station for automatic charging, bump testing, and calibrating monitors and printing certificates on a serial printer, or as part of an AutoRAE 2 Controller-based system, which can accommodate up to 10 AutoRAE 2 Cradles. These can be all the same or a mix of MultiRAE, MicroRAE, QRAE 3, and ToxiRAE Pro models, as well as MiniRAE Lite, MiniRAE 3000, ppbRAE 3000, and UltraRAE 3000.

When an AutoRAE 2 Cradle is connected to the AutoRAE 2 Controller, all electrical, electronic, and gas connections are automatically internally connected. A controller-based system can accommodate up to five distinct gas sources for multi-sensor calibration and bump testing.

An AutoRAE 2 Cradle can be used on a tabletop (or other flat surface) or mounted on a wall. Wall-mounting instructions are included in this guide.

MultiRAE Cradle

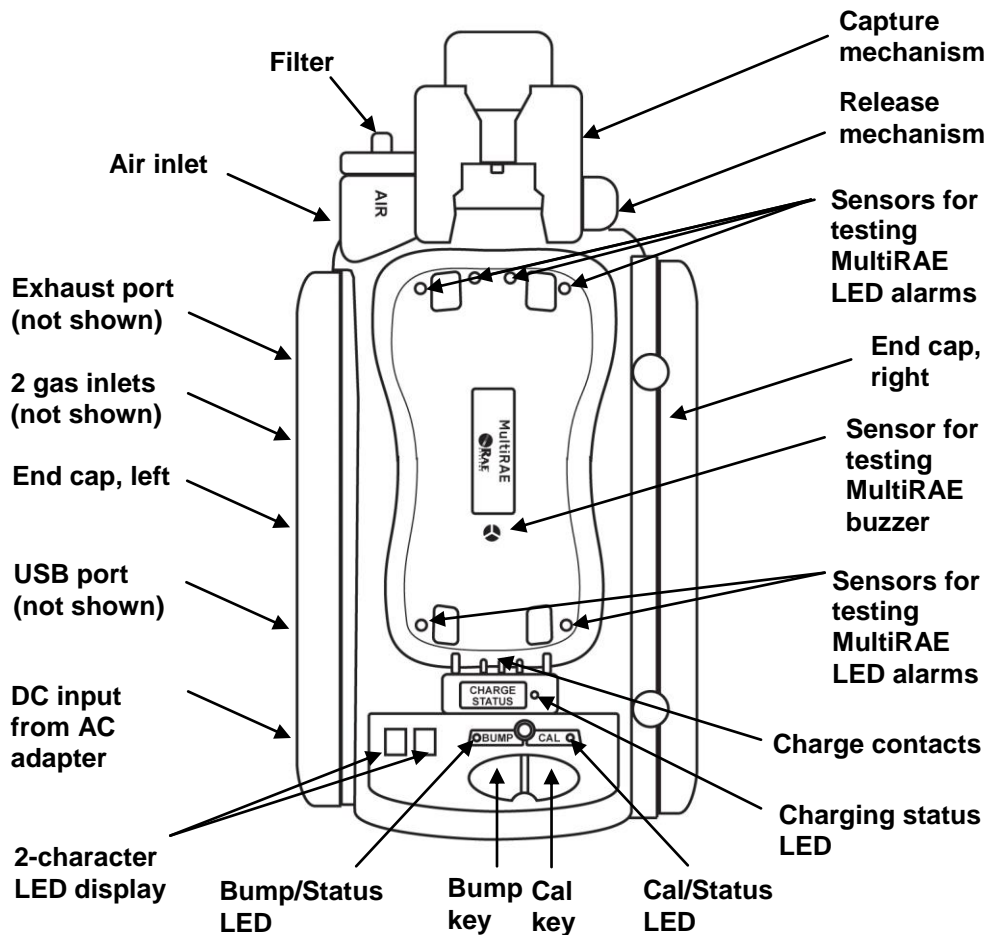

AutoRAE 2 User's Guide

ToxiRAE Pro Cradle

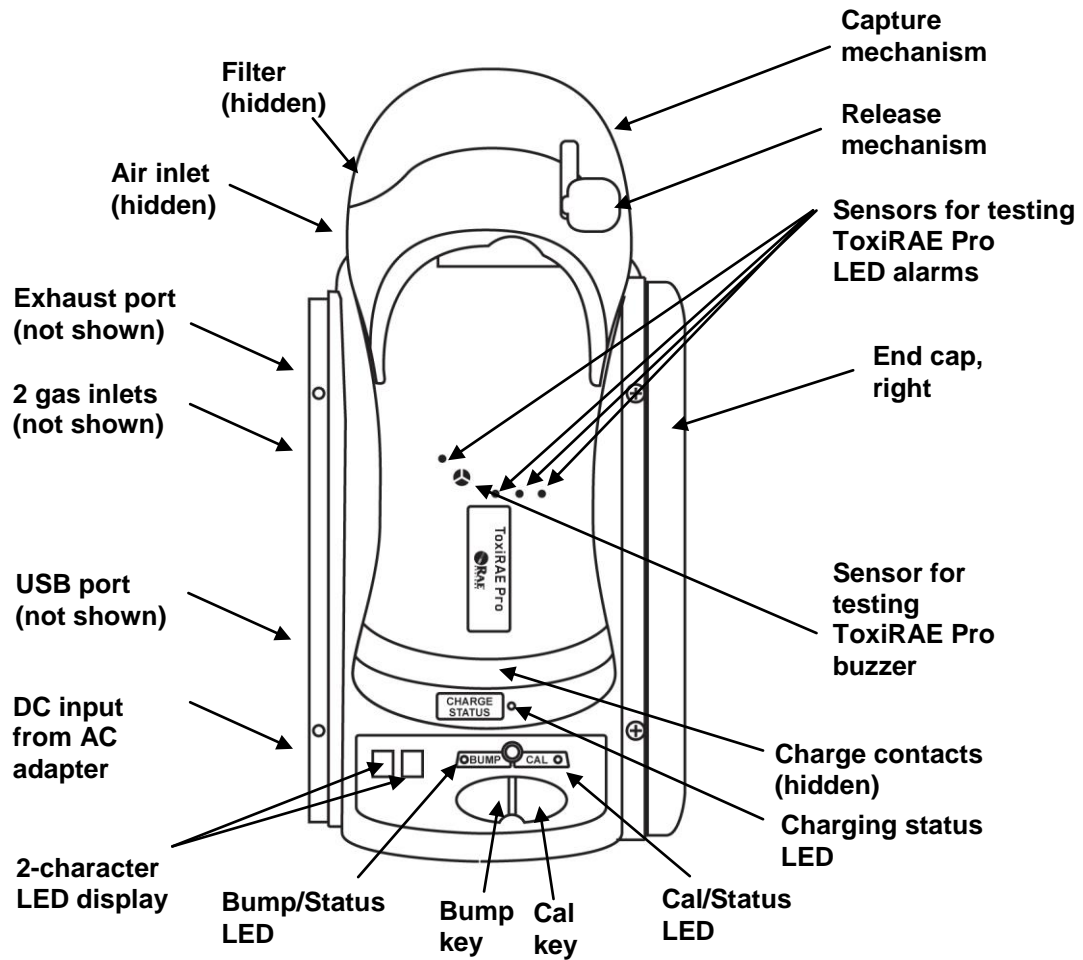

AutoRAE 2 User's Guide

QRAE 3 Cradle

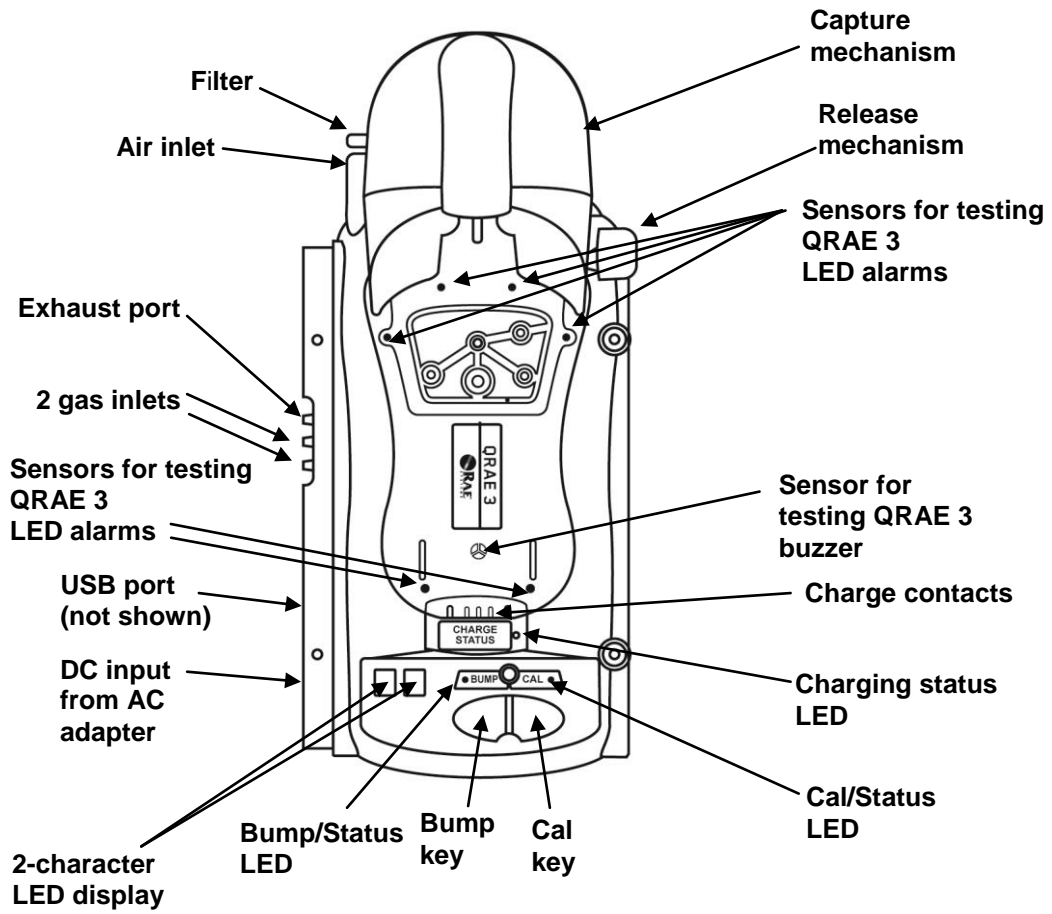

AutoRAE 2 User's Guide

MicroRAE Cradle

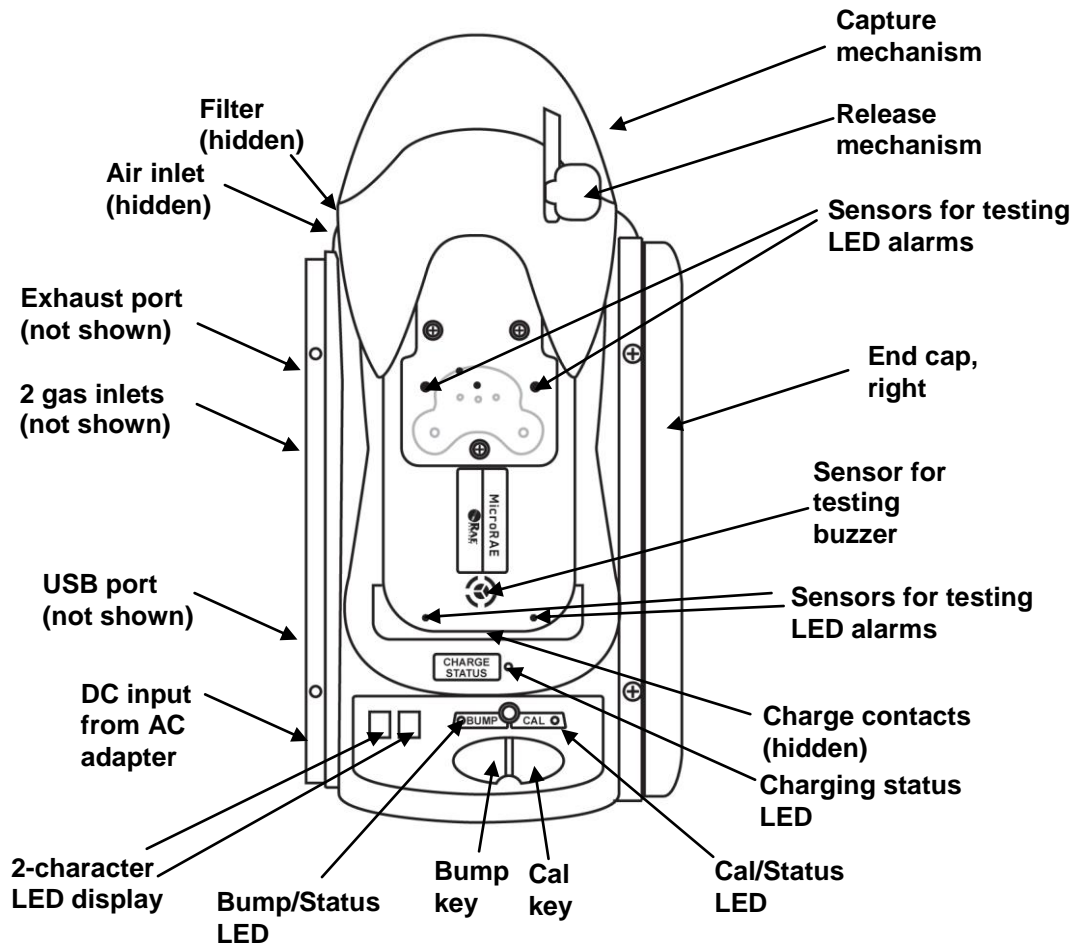

AutoRAE 2 User's Guide

Handheld PID Cradle

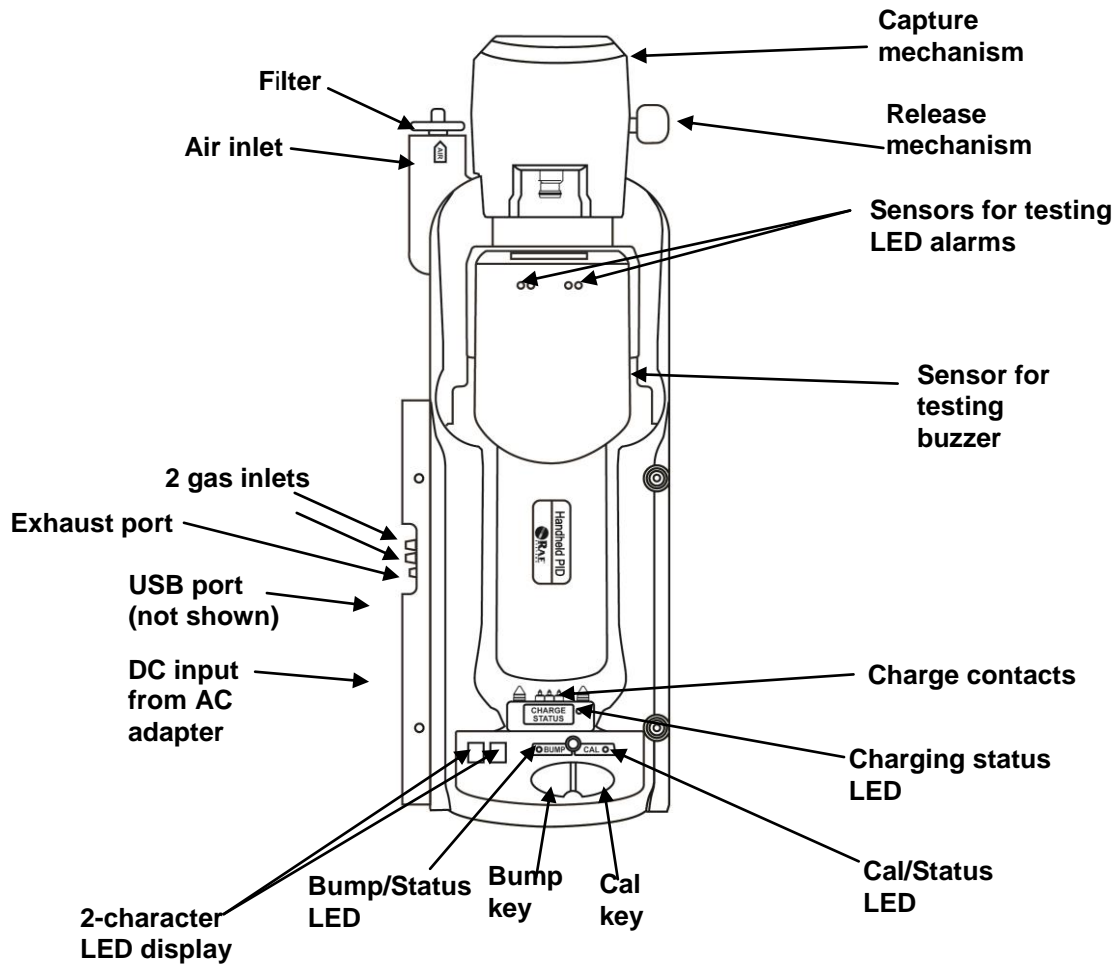

Extending the Handheld PID Cradle to accommodate an UltraRAE 3000

The UltraRAE 3000 has a gas separation tube holder that extends the length of the instrument. In order to accommodate the extra length, the Handheld PID Cradle is designed so that it extends.

1. Turn the Handheld PID Cradle over.
2. Remove the screw with the red washer.
3. Pull out the capture mechanism until it is fully extended.
4. Replace the screw.

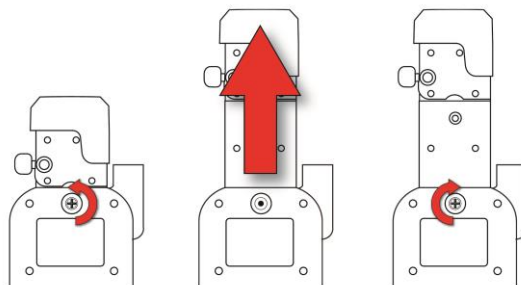

AutoRAE 2 User's Guide

End Cap With Ports, All Models

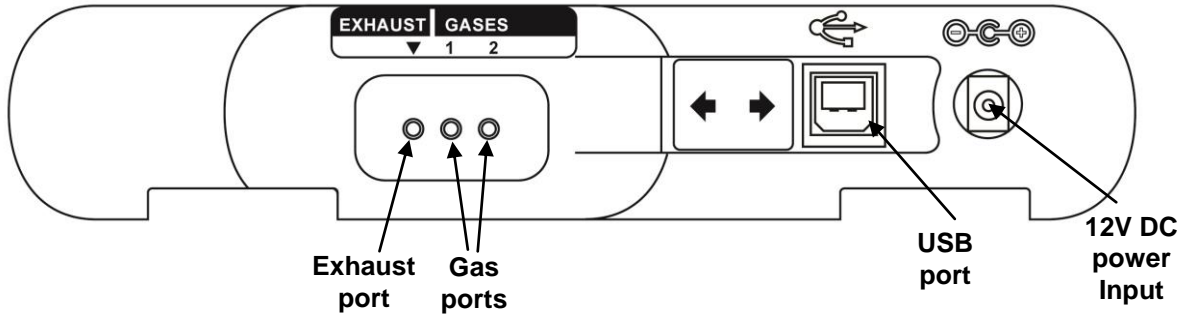

The USB port has a sliding cover that protects the contacts from contamination when it is not in use. Simply slide the cover over the port.

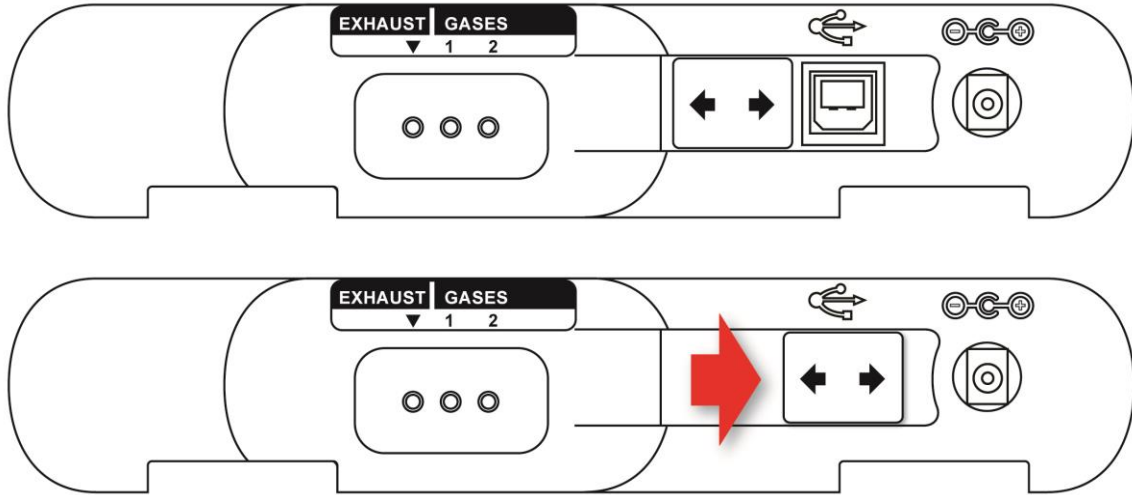

AutoRAE 2 User's Guide

3.1. Standard Package Contents

The AutoRAE 2 Cradle for MultiRAE Pumped Monitors (P/N T02-0103-000), QRAE 3 Pumped Monitors (P/N T02-0203-000), AutoRAE 2 Handheld PID Cradle (T02-0403-000), AutoRAE 2 Cradle for MicroRAE (P/N T02-0503-000), and AutoRAE 2 Cradle for ToxiRAE Pro Monitors (P/N T02-0003-000) are shipped with the following:

- AutoRAE 2 Cradle for MultiRAE Pumped Monitors, AutoRAE 2 Cradle for QRAE 3 Pumped Monitors, AutoRAE 2 Cradle for Handheld PID (MiniRAE Lite, MiniRAE 3000, ppbRAE 3000, and UltraRAE 3000), AutoRAE 2 Cradle for MicroRAE, or AutoRAE 2 Cradle for ToxiRAE Pro Monitors
- Left and right end caps (for deployment in stand-alone mode)
- For ToxiRAE Pro Cradle only: Cradle comes with ToxiRAE Pro Cradle adapters and stickers for different ToxiRAE Pro models
- Handheld PID Cradle only comes with 1 Quick Connector (P/N: T02-3301-000).
- 4 screws and 4 screw covers to attach the right end cap to the Cradle if deployed in stand-alone mode or Cradle to a controller-based system
- 12-volt, 1.25A power supply with interchangeable plugs, P/N 500-0114-000
- External inlet filters (except Handheld PID): 1 installed, three spare (P/N 008-3022-003, pack of 3)
- Active Carbon Filter (Handheld PID only), P/N: 490-0006-000
- AutoRAE 2 Handheld PID Cradle comes with 1 Quick Connector (P/N: T02-3301-000)
- Tygon tubing (1/8" I.D., 15mm long), pack of 5, P/N 411-0018-037-05
- PC Communications Cable, USB Type A (Male) to Type B (Male), P/N 410-0086-000
- Quick Start Guide, P/N T02-4014-000
- AutoRAE 2 Resource CD-ROM, P/N T02-4012-000
 - This disc includes:
 - User's Guide
 - QuickStart Guide
- ProRAE Studio II Instrument Configuration and Data Management Software CD-ROM, P/N 000-5007-001
- Product registration card
- Quality inspection and test certificate

4. Installing End Caps For Stand-Alone Use

The AutoRAE 2 Cradle is shipped with left and right end caps, which are intended to protect and label the ports on both sides of the AutoRAE 2 Cradle. The one for the “input” side (left end cap) snaps on, while the one on the other side (right end cap) gets slipped into its position and is then secured with two screws (plastic caps are included, to hide the screws).

Note: The same end caps fit all cradle models.

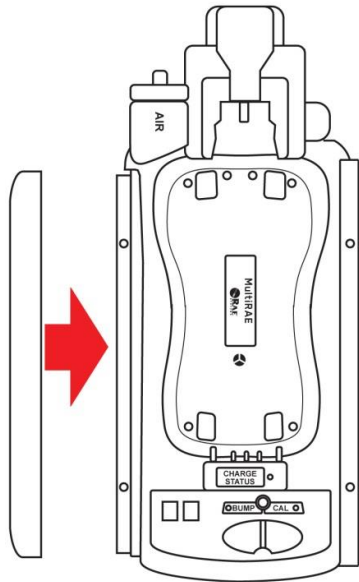

Slide the cap over the end and snap it into place.

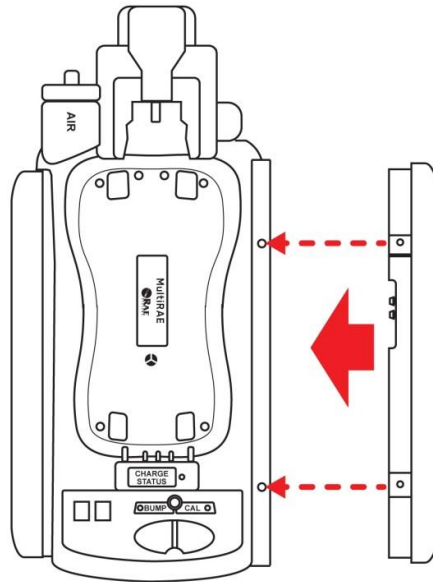

Slide the second cap into place.

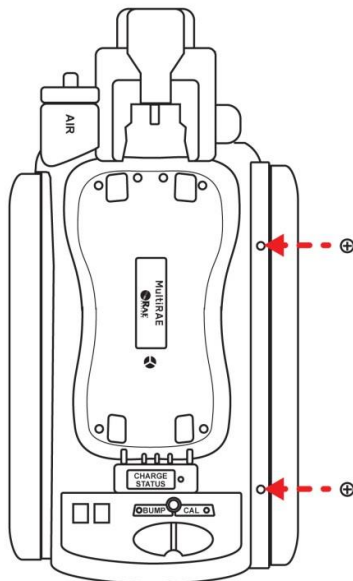

Insert the two screws.

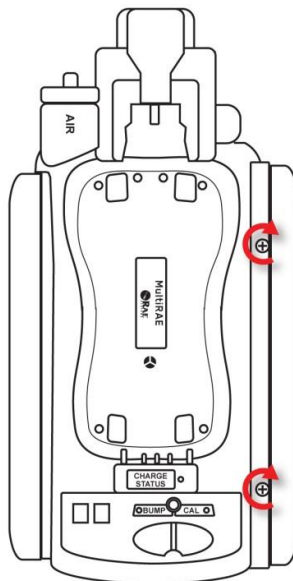

Tighten the screws.
Do not overtighten!

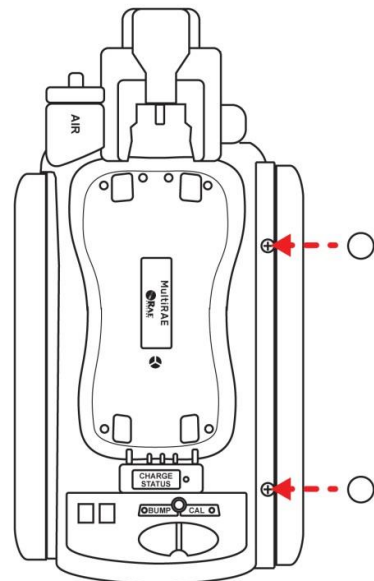

Press the caps over the screws.

5. Powering The AutoRAE 2 Cradle

When used as a stand-alone unit, the AutoRAE 2 Cradle is powered by its own AC adapter. (When an AutoRAE 2 Cradle is attached to an AutoRAE 2 Controller, it receives its power from the AutoRAE 2 Controller, and therefore does not need a separate AC adapter.) The jack for the AC adapter connection is in the recess of the left end cap. Plug the barrel end of the AC adapter into the AutoRAE 2 Cradle and the transformer into an AC outlet.

Caution: Never use the AutoRAE 2 Cradle or its AC adapter in wet or damp environments or hazardous locations.

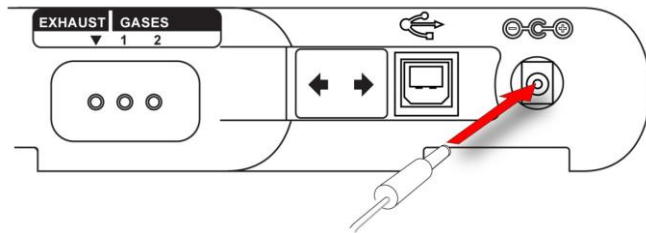

Plug barrel from AC
adapter into jack

6. Preparing For Bump Testing & Calibration

Before performing a bump test or calibration, the AutoRAE 2 Cradle must be set up, filter installed, and power applied. In addition, it must be configured using ProRAE Studio II software to set the gas types and concentrations, as well as the time and date. See page 37 for details.

6.1. Installing An External Filter

In order to ensure that fresh air is uncontaminated by dust or other materials, use a filter on the AutoRAE 2 Cradle's fresh air inlet. The inlet is located on the top end, to the left of the locking mechanism. Inspect the filter periodically and replace it as necessary if dirty, damaged, or contaminated.

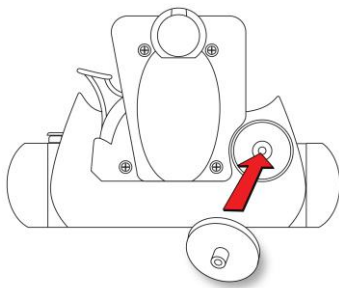

Press filter onto receptacle

6.2. Installing An External Charcoal Filter

When zeroing the ppbRAE 3000, it is necessary to use an external charcoal filter for the truest zero readings (alternatively, you can use ultra-pure zero air). It is also a good idea to use a charcoal filter anywhere that the ambient air has VOC (volatile organic compounds). The Active Carbon Filter (P/N: 490-0006-000) filters out VOC from the air. To install the charcoal filter on the cradle, remove the plastic filter adapter by twisting the plastic filter clockwise while gently pulling outward. The Active Carbon Filter is designed for 20 uses. To help you keep track of how many calibrations are performed, there are 20 small boxes painted on the surface of the filter that you can mark with a pen after each use.

Simply press it into the receptacle on the AutoRAE 2 cradle.

Note: Make sure the arrow on the side of the filter points toward the cradle.

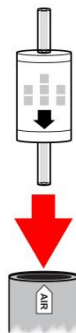

AutoRAE 2 User's Guide

6.3. Connecting An AC Adapter

The AutoRAE 2 Cradle uses a 12V, 1.25A DC adapter. Plug the barrel end into the port on the side of the AutoRAE 2 Cradle and the transformer end into an AC power source. There is no power switch, so when power is applied to the AC adapter, the AutoRAE 2 Cradle is powered.

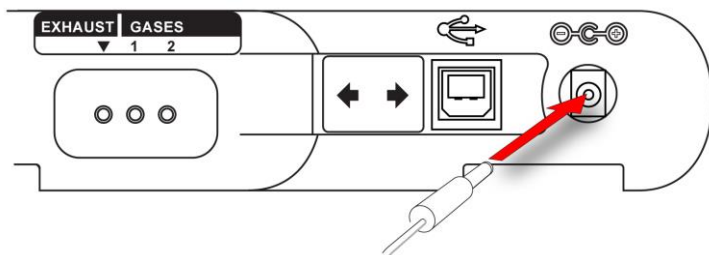

Caution: Never use the AutoRAE 2 Cradle or its AC adapter in wet or damp environments or hazardous locations.

AutoRAE 2 User's Guide

6.4. Connecting Calibration Gas

The AutoRAE 2 Cradle can accommodate two gas calibration gas cylinders (mixture or single gas in each). In addition, there is a connection labeled “Exhaust,” for venting the gas after it has gone through the AutoRAE 2 Cradle. All three connections are barbed to secure the hoses to them. All gas connections are barbed to secure the hoses to them. Appropriately non-reactive/non-adsorptive tubing with a 1/8" I.D. should be used (Teflon for PID or corrosive or reactive gases, Tygon for others). The cylinders must have demand-flow regulators (0 to 1,000 psig/70 bar) installed.

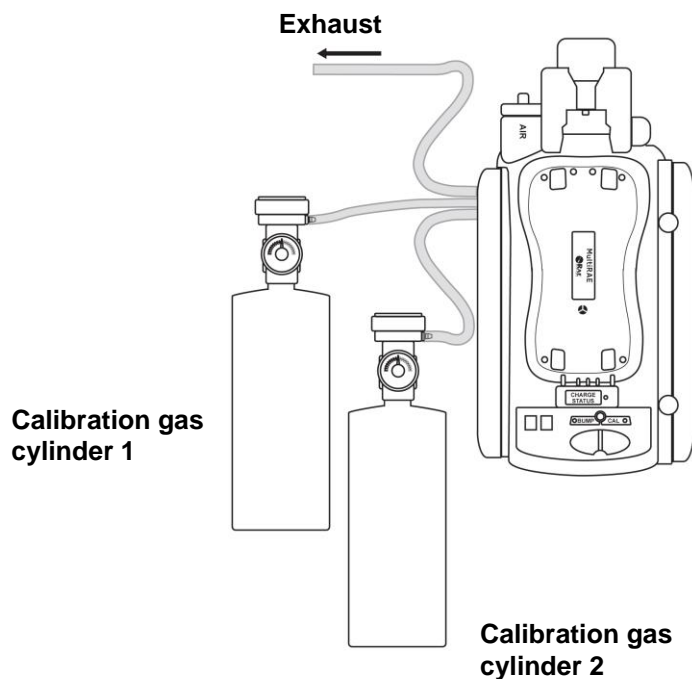

IMPORTANT!

Always check that the active gas configuration on the AutoRAE 2 Cradle and the type/concentration of the actual calibration gases connected to the Cradle match before you begin any bump test or calibration.

Cross-Sensitivities Determine The Order In Which Sensors Should Be Calibrated

Gases used for calibration should be configured and connected to inlet 1 and then inlet 2 in the order in which the sensors should be calibrated. This applies to both a standalone cradle and controller-based systems. Information on the order of calibration is available in RAE Systems Technical Note TN-114.

If MultiRAE sensors have cross-sensitivities to the target gas(es) of other sensors installed in the same instrument, the order in which such sensors are calibrated is important, as time is required between calibrations to allow the sensors to clear after exposure to cross-sensitive gas. To shorten the time required to perform calibration,

AutoRAE 2 User's Guide

calibrate the most cross-sensitive sensor first, followed by the least cross-sensitive. Wait for both sensors to recover to zero, and then expose both to gas again with most cross sensitive first and least cross sensitive second.

For example, 50 ppm of NH_3 produces 0 ppm response on a Cl_2 (less cross-sensitive) sensor and 1 ppm of Cl_2 produces about -0.5 ppm of response on a NH_3 (more cross-sensitive) sensor. So calibrate the NH_3 sensor first with 50 ppm of NH_3 . This should have no effect on the Cl_2 sensor. Then calibrate the Cl_2 sensor with 10 ppm Cl_2 . This will send the NH_3 sensor negative for some period of time.

After calibrating the Cl_2 sensor, return the instrument to clean air and wait until the most cross-sensitive sensor (NH_3) fully recovers and/or stabilizes (if it stabilizes to a number other than zero, then re-zero the instrument).

After both sensors return to zero, expose both to calibration gas in the same order (NH_3 first, and then Cl_2 .) Note the sensor response. If both sensors are within 10% of the value shown on the gas cylinder, then the calibration of the cross-sensitive sensors was successful.

This same logic applies to the order of performing a bump test on an instrument that has cross-sensitive sensors. For more information on cross-sensitivities for select sensors, consult RAE Systems Technical Note TN-114.

AutoRAE 2 User's Guide

6.5. Placing A MultiRAE Monitor In The Cradle

1. Make sure the external filter on the instrument is not dirty or clogged and screwed onto the instrument inlet tightly.
2. Make sure the monitor is either turned off or is in AutoRAE 2 Communications Mode.
3. Place the instrument into the cradle face-down, making sure that it is aligned correctly with the contacts on the AutoRAE 2 Cradle's charging port. There are two alignment points on one side and one alignment point on the other side, designed to mate with matching points on the bottom of the MultiRAE.
4. Press in on the capture mechanism to lock the MultiRAE in place.

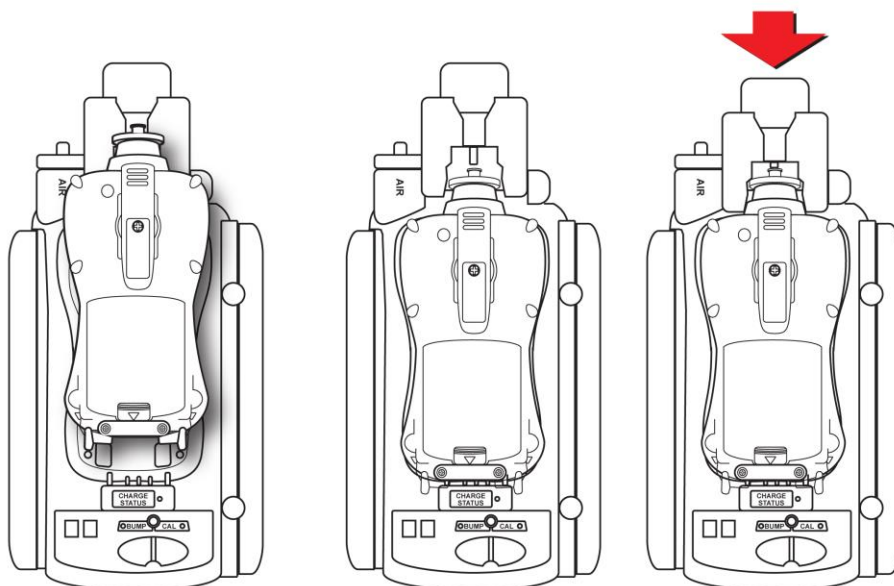

Note: there is no need to remove the external filter, rubber boot, belt clip or wrist strap from the monitor to use it with the AutoRAE 2.

AutoRAE 2 User's Guide

6.6. Placing A ToxiRAE Pro Monitor In The Cradle

The ToxiRAE Pro cradle requires one of two different adapters, and each is specific to the type of ToxiRAE Pro. They click into place and can be easily removed, in case you want to use one cradle for bump testing/calibrating/managing different types of ToxiRAE Pro monitors.

6.6.1. Installing Adapters In The ToxiRAE Pro Cradle

The two types of ToxiRAE Pro adapters are shown here:

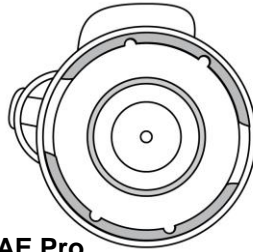

**Adapter for ToxiRAE Pro,
ToxiRAE Pro CO₂ and
ToxiRAE Pro LEL**

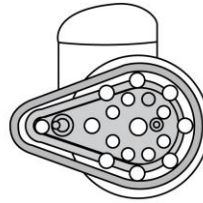

**Adapter for
ToxiRAE Pro PID**

Align the two holes in the appropriate adapter with the two matching ports inside the Capture Mechanism.

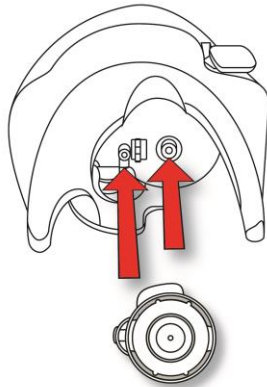

**Adapter for ToxiRAE Pro,
ToxiRAE Pro CO₂ and
ToxiRAE Pro LEL**

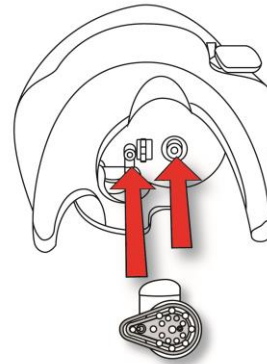

**Adapter for
ToxiRAE Pro PID**

Note: The adapters can be removed by pulling on the “thumb tab” at the top of each one (it fits into a niche in the capture mechanism).

AutoRAE 2 User's Guide

Each adapter comes with a sticker for the inside of the cradle. It is especially recommended that you install these stickers, particularly if both types of adapters are being used in multiple cradles connected to an AutoRAE 2 Controller.

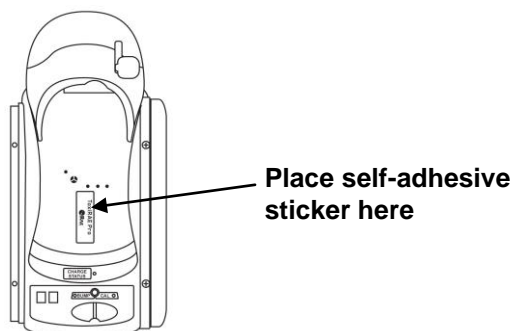

6.6.2. Placing A ToxiRAE Pro Monitor In The Cradle

1. Make sure the correct adapter is located in the cradle's capture mechanism.
2. Make sure the external filter on the instrument is not dirty or clogged and screwed onto the instrument inlet tightly.
3. Make sure the monitor is either turned off or is in AutoRAE 2 Communications Mode.
4. Place the instrument into the cradle face-down, making check that it is aligned correctly with the contacts on the AutoRAE 2 Cradle's charging port.
5. Press in on the capture mechanism to lock the ToxiRAE Pro in place.

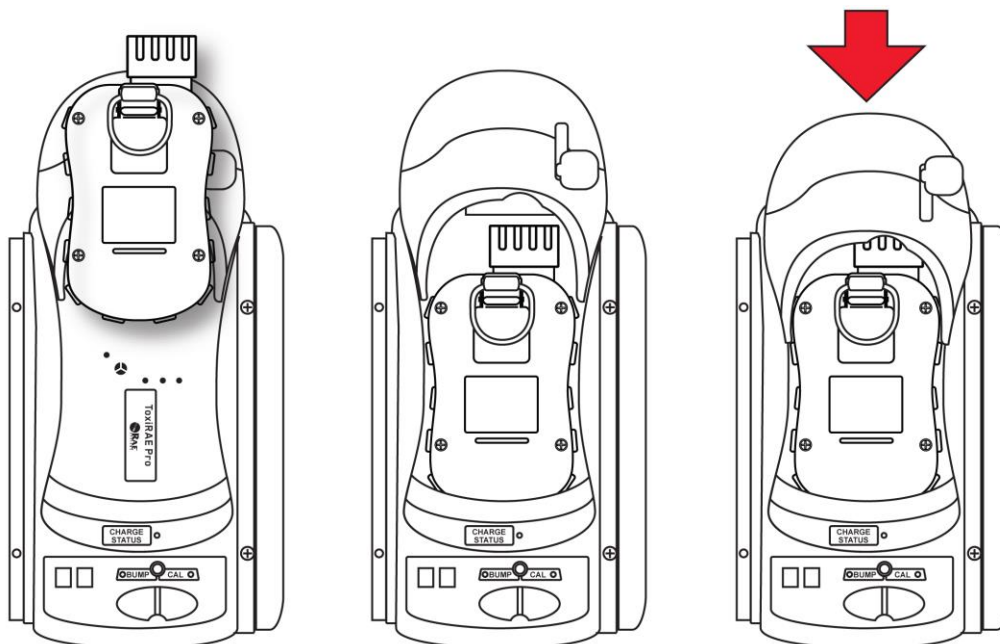

Note: There is no need to remove the external filter, rubber boot, belt clip or wrist strap from the monitor to use it with the AutoRAE 2.

AutoRAE 2 User's Guide

6.7. Placing A QRAE 3 Monitor In The Cradle

1. Make sure the external filter on the instrument is not dirty or clogged and screwed onto the instrument inlet tightly.
2. Make sure the monitor is either turned off or is in AutoRAE 2 Communications Mode.
3. Place the instrument into the cradle face-down, making sure that it is aligned correctly with the contacts on the AutoRAE 2 Cradle's charging port. There are two alignment points on one side and one alignment point on the other side, designed to mate with matching points on the bottom of the QRAE 3.
4. Press in on the capture mechanism to lock the QRAE 3 in place.

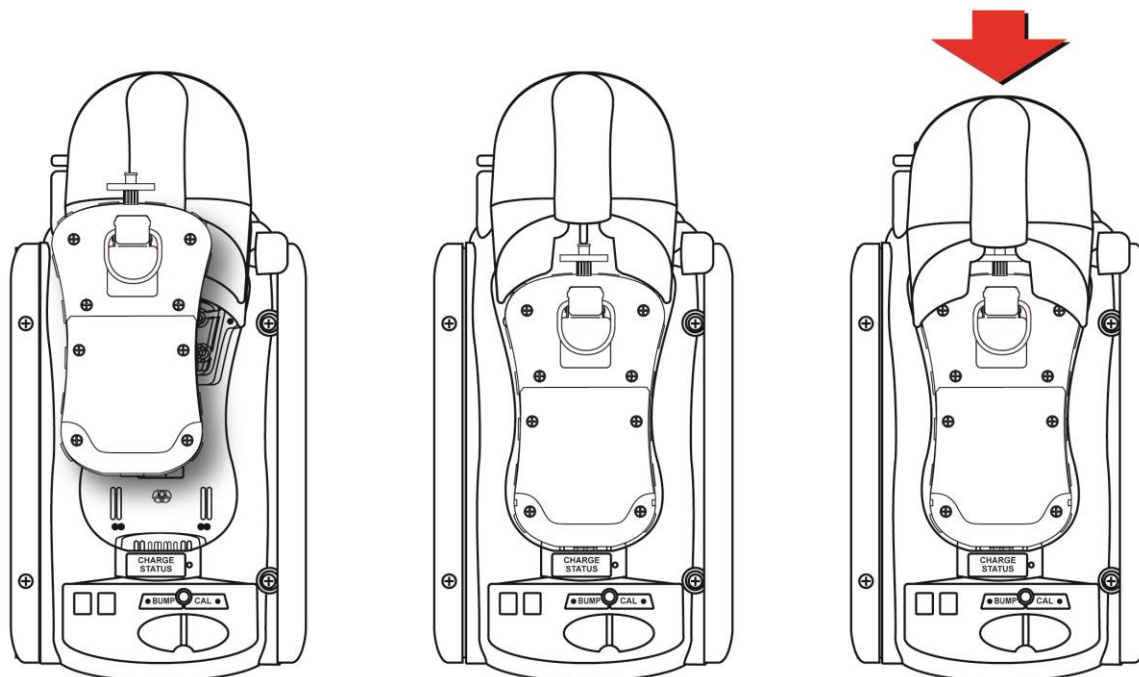

Note: There is no need to remove the external filter, belt clip or wrist strap from the monitor to use it with the AutoRAE 2.

AutoRAE 2 User's Guide

6.8. Placing A MicroRAE Monitor In The Cradle

1. Remove the external filter from the instrument.
2. Make sure the monitor is either turned off or is in AutoRAE 2 Communications Mode.
3. Place the instrument into the cradle face-down, making sure that it is aligned correctly with the contacts on the AutoRAE 2 Cradle's charging port. There are two alignment points on one side and one alignment point on the other side, designed to mate with matching points on the bottom of the MicroRAE.
4. Press in on the capture mechanism to lock the MicroRAE in place.

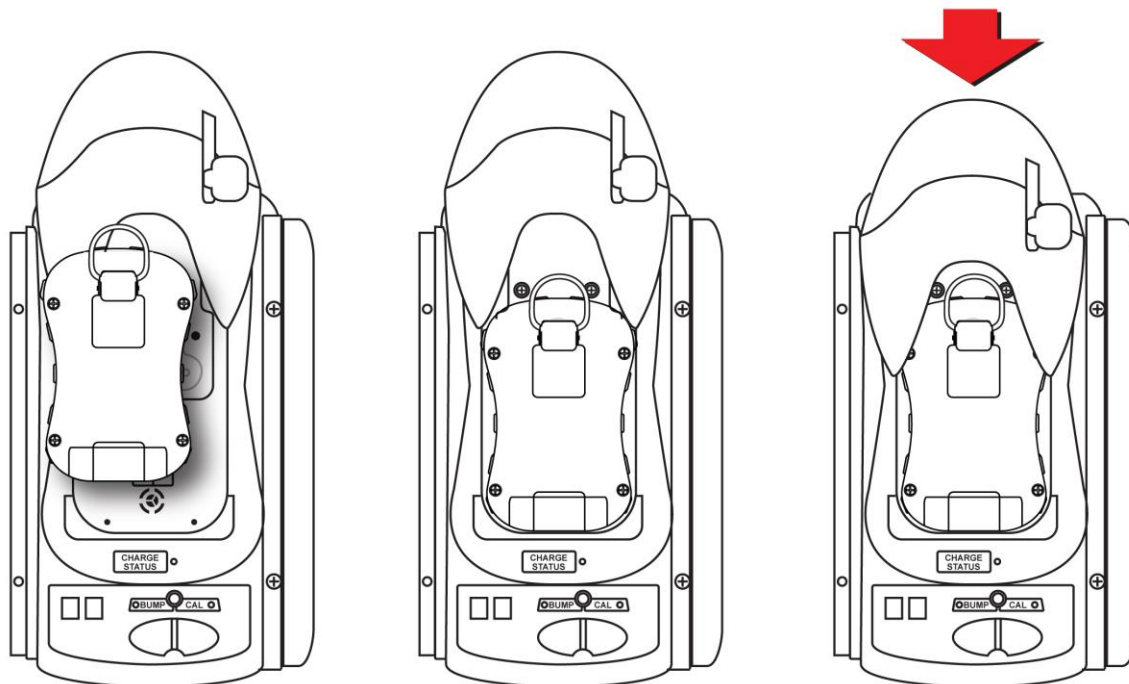

Note: There is no need to remove the belt clip or wrist strap from the monitor to use it with the AutoRAE 2.

6.9. Placing A Handheld PID Monitor In The Cradle

You must remove the inlet probe before placing a handheld PID instrument (MiniRAE Lite, MiniRAE 3000, ppbRAE 3000, or UltraRAE 3000) into the cradle. If the instrument does not have a Quick Connector (P/N: T02-3301-000) already installed, you must install one.

6.9.1. Installing A Quick Connector

MiniRAE Lite, MiniRAE 3000,
or ppbRAE 3000:

UltraRAE 3000:

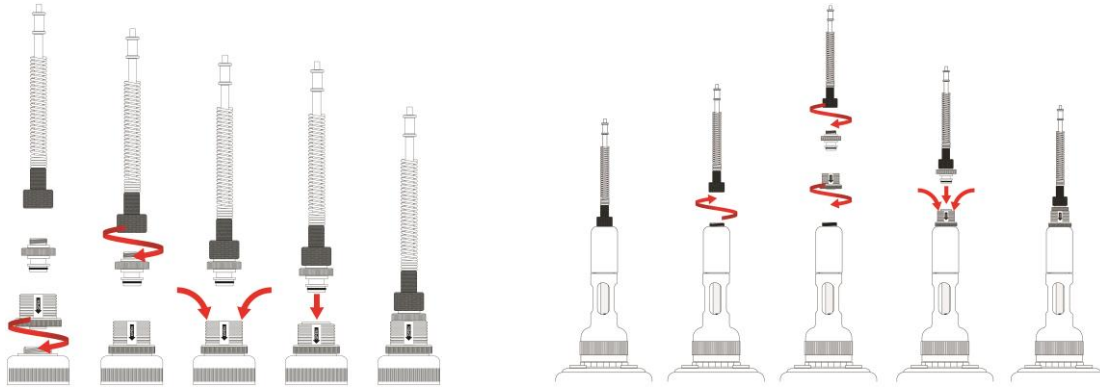

To remove the inlet:

1. Press down on the collar of the Quick Connector base.
2. Lift the inlet probe off of the base.

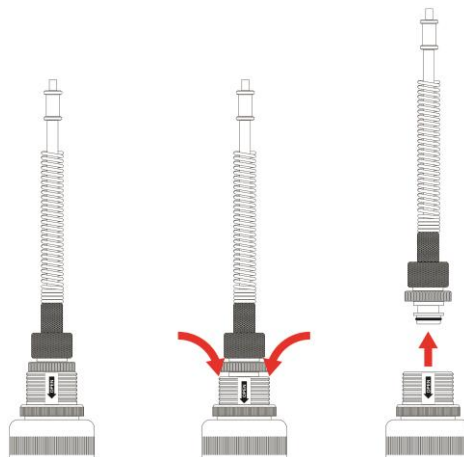

AutoRAE 2 User's Guide

6.9.2. Installing The Instrument In the Cradle

If the instrument is equipped with a Quick Connector, install the instrument in the cradle:

1. Remove the inlet probe by pressing down on both sides of the base and releasing the probe.
2. Make sure the monitor is either turned off or is in AutoRAE 2 Communications Mode.
3. Place the instrument into the cradle face-down, making sure that it is aligned correctly with the contacts on the AutoRAE 2 Cradle's charging port. There are two alignment points on one side and one alignment point on the other side, designed to mate with matching points on the bottom of the instrument.
4. Press in on the capture mechanism to lock the instrument in place.

For MiniRAE Lite, MiniRAE 3000, or ppbRAE 3000:

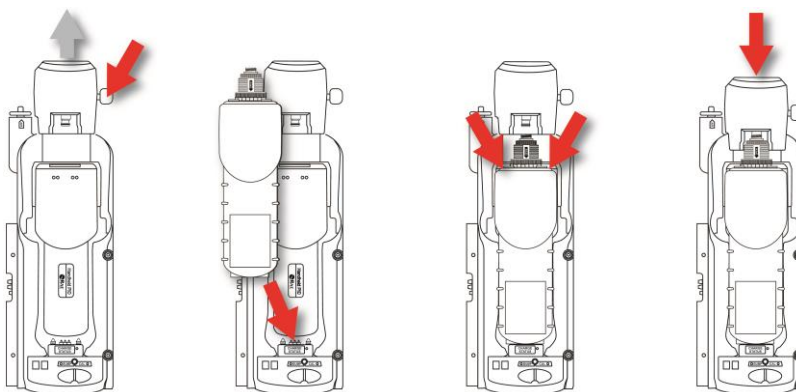

For UltraRAE 3000:

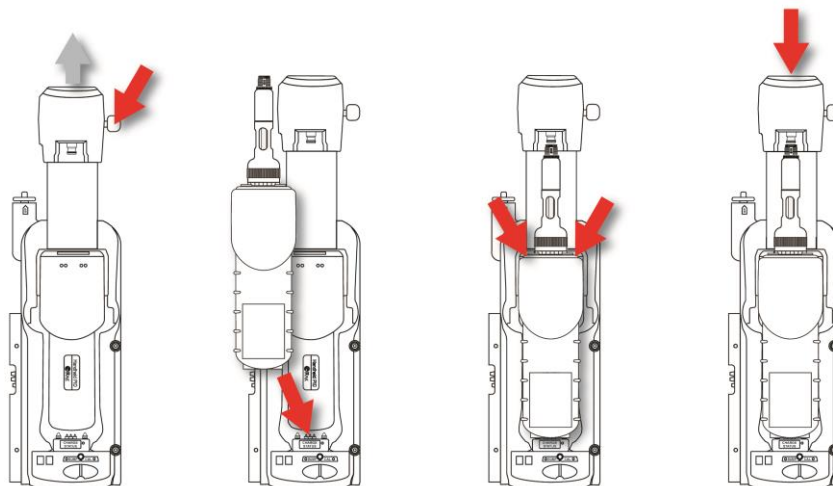

AutoRAE 2 User's Guide

6.10. Warm-Up

When you place a monitor in the cradle and lock the capture mechanism, the Cradle automatically starts charging the instrument and initiates a warm-up cycle to prepare the instrument for bump testing or calibration. In order for the warm-up cycle to commence, however, the monitor needs to be either turned off or in AutoRAE 2 Communications mode.

The warm-up time depends on the sensors installed in the instrument and their individual warm-up requirements. During warm-up, the two Cradle LEDs labeled “Bump” and “Cal” blink orange in alternation. When the instrument is warmed up, the two LEDs glow continuously green, indicating that you may now perform a bump test or calibration.

If the instrument fails to warm up, the Cradle’s Bump and Cal LED lights will blink red in alternation and the buzzer will alarm. Remove the monitor from the cradle and refer to the information on the instrument display.

An instrument to be placed in the cradle can be off or turned on and set for AutoRAE 2 Communications mode.

1. When you place an instrument that is turned off into the Cradle, the Cradle automatically starts charging the instrument and initiates a warm-up cycle to prepare the instrument for bump testing or calibration.
Note: If the instrument’s voltage is too low to power on, the cradle initiates a warm-up cycle until the voltage is sufficient to power on. That is to say the identification time is longer.
2. When instruments are turned on and entered into AutoRAE 2 communication mode, they are treated in different ways. Refer to this following table:

Instrument	Instrument powered off		Instrument powered on and in AutoRAE 2 Communications Mode	
	Time	Comments	Time	Comments
MultiRAE	2'12"	Performs self-test. PID sensor needs 2 minutes to warm up.	6"	All sensors are warmed. Mode transmits only. No self-test is performed.
ToxiRAE Pro	1'26"	Performs self-test. PID sensor needs 1 minute to warm up.	25"	All sensors are warmed. Performs self-test.
QRAE 3	1'22"	Performs self-test. Sensors need 1 minute to warm up.	8"	All sensors are warmed.
MiniRAE Lite	10"	Performs self-test.	6"	Sensor is warmed and AutoRAE 2 is ready
MicroRAE	30"	Performs self-test.	12"	All sensors are warmed.
MiniRAE 3000, ppbRAE 3000, UltraRAE 3000	10"/20"	Performs self-test. Normal time is 10". If wireless is supported, it requires 20".	6"	Sensor is warmed and AutoRAE 2 is ready

Important! If sensors are still warming when entering AutoRAE 2 Communications Mode, the instrument will not be ready until the sensors are warmed.

7. Performing A Bump Test

RAE Systems recommends that a bump test be performed on all portable instruments prior to each day's use. A bump test is defined as a brief exposure of the monitor to the test gas to make sure that sensor respond to gas and alarms are functional and enabled.

- The monitor must be calibrated if it does not pass a bump test, or at least once every 180 days, depending on use and sensor exposure to poisons and contaminants.
 - Calibration intervals and bump test procedures may vary due to national legislation.
1. Connect calibration gas cylinders that match the gas settings configured on the Cradle (as specified for Bottles 15 and 16 under Gas Config 8; see Section 13.1).
 2. Insert an instrument in the AutoRAE 2 Cradle (as described in Section 6.4) and wait for it to warm up (as described in Section 6.5).
 3. When the instrument is warmed up (both LEDs are glowing green), press “Bump” to initiate a bump test. The Cradle produces a beep to signal the start of a bump test.
 4. The Bump LED flashes green when a bump test is under way. The Cal LED stays dark.
 5. If the instrument passes a bump test, the Bump LED will turn solid green.

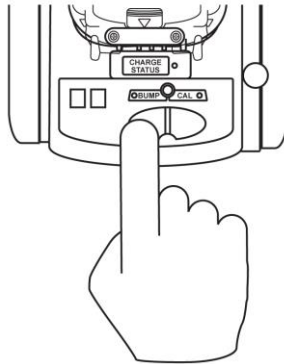

Note: See page 32 for an explanation of the LED indications that tell you which operations are underway and which LED indications tell you of errors during a bump test.

Note: In its standard configuration, if the instrument does not successfully pass a bump test, the AutoRAE 2 Cradle automatically initiates a full calibration.

8. Performing A Calibration

All portable instruments must be calibrated periodically in accordance with national and regional regulations, but no less frequently than every 180 days. Always perform a full calibration after replacing a sensor, using a new instrument for the first time, or if the instrument has been unused for a long period of time. In addition, if the instrument has failed a bump test, perform a full calibration as well.

1. Connect calibration gas cylinders that match the gas settings configured on the Cradle (as specified for Bottles 15 and 16 under Gas Config 8; see Section 12.1).
2. Insert an instrument in the AutoRAE 2 Cradle (as described in Section 6.5) and wait for it to warm up (as described in Section 6.10).
3. When the instrument is warmed up (both LEDs are glowing green), press “Cal” to initiate a calibration. The Cradle produces a beep to signal the start of the calibration process.
4. The Cal LED flashes green when a calibration is under way. The Bump LED stays dark.
5. If a calibration completes successfully, the Cal LED will turn solid green.

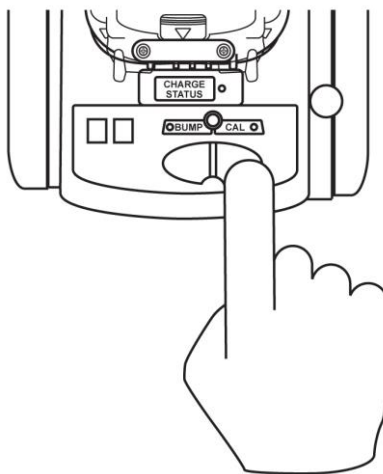

Note: See page 32 for an explanation of the LED indications that tell you which operations are underway and which LED indications tell you of errors during calibration.

9. Bump And Cal Error And Status Messages

The LEDs labeled “Bump” and “Cal” above the two keys on the AutoRAE 2 Cradle provide information about status during bump and calibration testing. The following table explains the various messages:

Status	Bump LED	Cal LED	User Action
Warm-up in progress	Orange blinking in alternation with Cal LED	Orange blinking in alternation with Bump LED	Pressing keys has no effect.
Warm-up error	Red blinking in alternation with Cal LED	Red blinking in alternation with Bump LED	Remove the instrument from the cradle and take the action indicated on the instrument's display.
Warm-up completed successfully	Green (solid)	Green (solid)	Press Bump or Cal key to perform a bump test or calibration.
Bump test in progress	Green (blinking)	Off	Do not remove the instrument, or the process will be interrupted. Pressing keys has no effect.
Bump test completed successfully	Green (solid)	Off	The bump test result (pass) has been logged. You may remove the instrument from the Cradle for use or leave it on the Cradle for the next AutoRAE 2 operation or to charge its battery.

AutoRAE 2 User's Guide

Status	Bump LED	Cal LED	User Action
Bump test failed	Red (blinking slowly)	Off	The bump test result (fail) has been logged.
Calibration in progress	Off	Green (blinking)	Do not remove the instrument, or the process will be interrupted. Pressing keys has no effect.
Calibration completed successfully	Off	Green (solid)	The result (pass) has been logged. You may remove the instrument from the Cradle for use or leave it on the Cradle for the next AutoRAE 2 operation or to charge its battery.
Calibration failed	Off	Red (blinking slowly)	The result has been logged in the instrument; you may remove it from the Cradle and read its display for an error code. If a Controller is used, the Controller's display shows the error code.
Sleep mode	Orange (solid)	Orange (solid)	Charging continues when in sleep mode. Press either key to wake up the instrument.
Monitor not connected / system idle	Off	Off	Check to make sure the monitor is properly installed in the cradle and the capture mechanism is fully engaged. Check to make sure the monitor is in AutoRAE 2 Communications Mode or turned off.
Cradle error	Red (blinking slowly at the same time as the Cal LED)	Red (blinking slowly at the same time as the Bump LED)	Take the action indicated in the Controller's display, if used. Otherwise, contact RAE Systems Technical Support.

10. Charging An Instrument's Battery

Placing an instrument in the cradle and locking it in position allows the instrument's battery to be charged.

When power is applied to the AutoRAE 2 Cradle and the instrument's battery is charging, the LED glows red.



The LED glows green when the battery is fully charged:

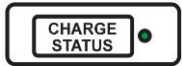

11. Removing An Instrument From A Cradle

When you want to remove an instrument from a cradle, press down on the red release lever until the capture mechanism springs forward, releasing the instrument. Then lift the instrument from the cradle, inlet side first.

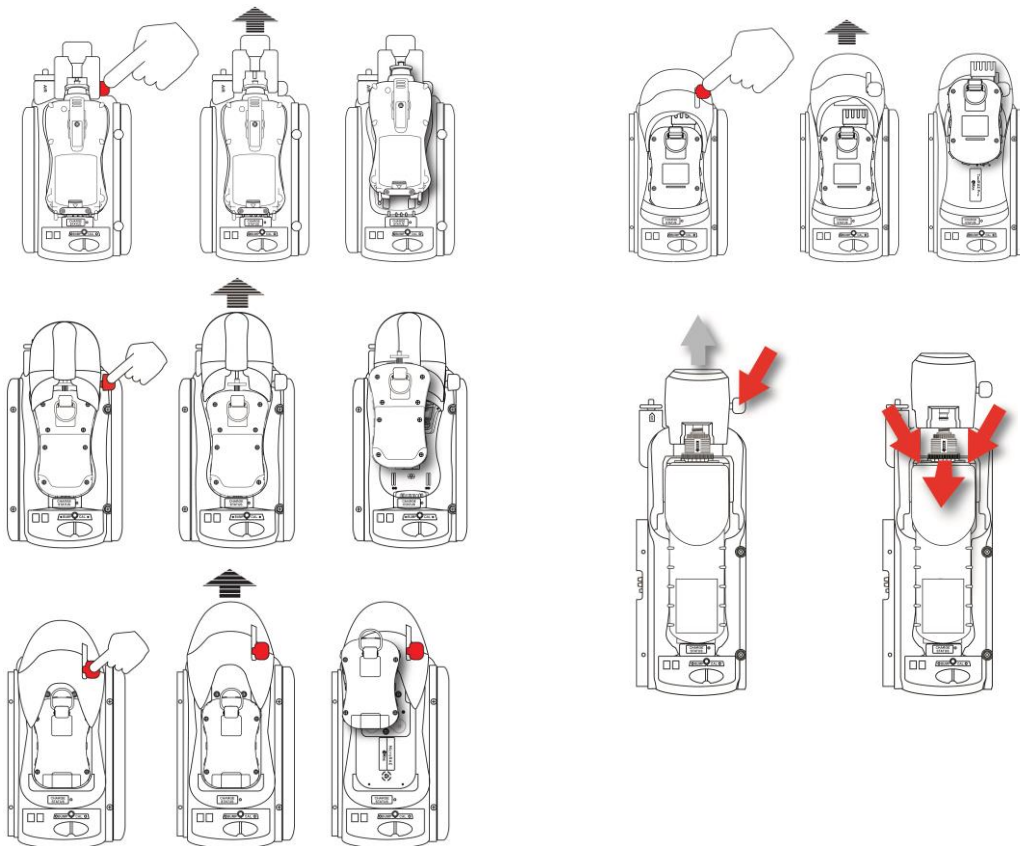

IMPORTANT!

If you remove an instrument that is warming up or under bump test or calibration, the process is interrupted, and requires that you place the instrument back in the cradle to restart the process. An interrupted process cannot be resumed.

AutoRAE 2 User's Guide

11.1. AutoRAE 2 Reports

After you perform any test on an instrument, the display on the instrument gives a report for each test that has been done.

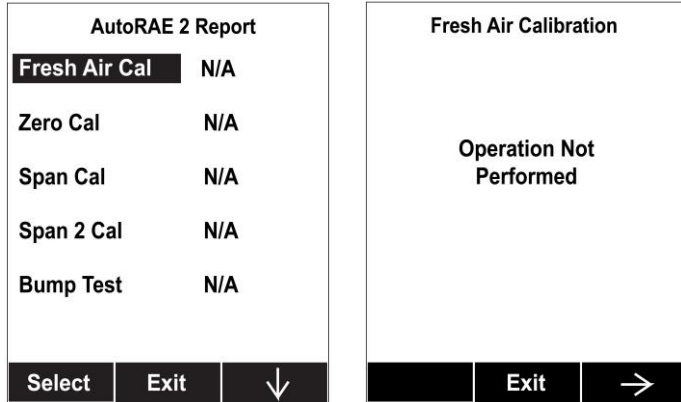

Step through the screens to see results from tests that were performed. For example, on the MultiRAE:

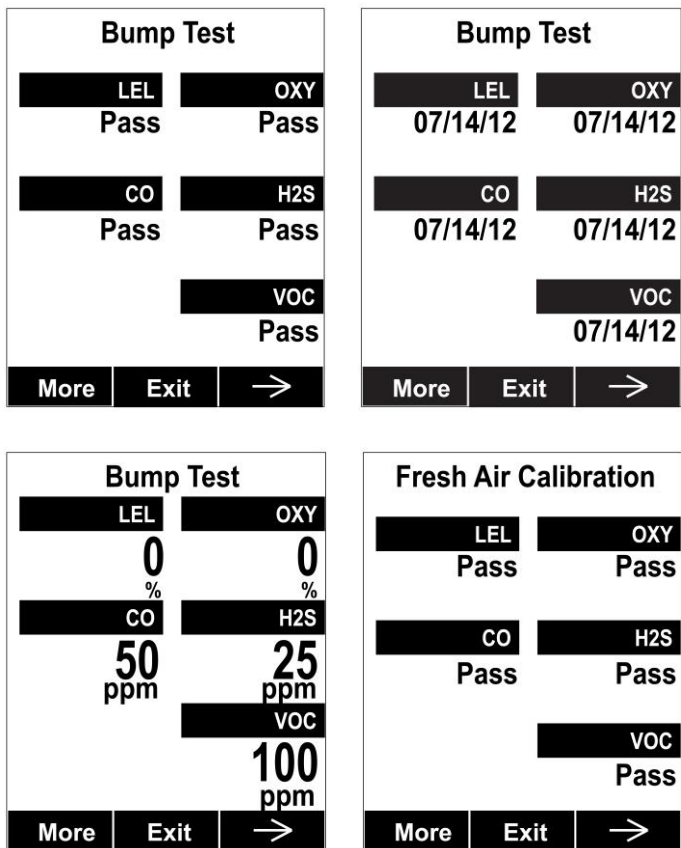

AutoRAE 2 User's Guide

Select Exit to return the monitor to Normal Measurement Mode.

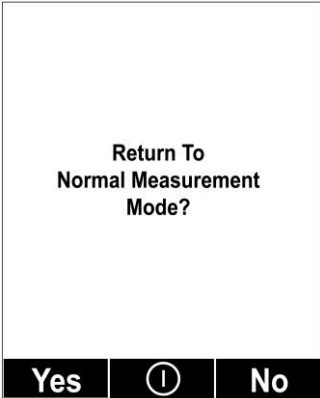

12. Programming A Stand-Alone AutoRAE 2 Cradle

The AutoRAE 2 Cradle gas configurations (gas inlet settings) as well as the system date and time comprise the configurable parameters available for an AutoRAE Cradle. You need a PC, ProRAE Studio II Instrument Configuration and Data Management Software, the AutoRAE 2 Cradle connected to a power source, and a USB PC communications cable.

1. Connect a USB cable between a PC with ProRAE Studio II and the AutoRAE 2 Cradle.
2. Make sure the AutoRAE 2 Cradle is on (AC adapter connected and plugged in).
3. Put the Cradle into PC communications mode. Press and hold the “Bump” key for five seconds, until the 2-digit LED display at the bottom left of the Cradle shows “PC.”
4. Start ProRAE Studio II software on the PC.
5. Select “Administrator” and input the password (the default is “rae”).
6. Click “Detect the instruments automatically” (the magnifying glass icon with the letter “A” in it). After a few seconds, the cradle is found and is shown.
7. Click “Select.”

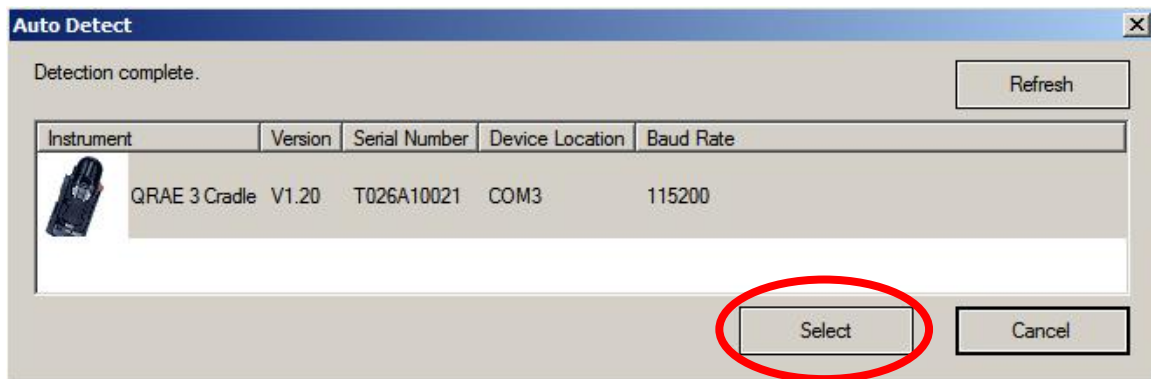

8. Click “Setup.”

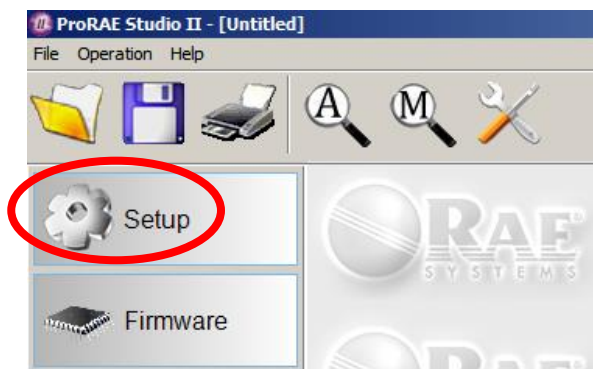

AutoRAE 2 User's Guide

9. ProRAE Studio II downloads the AutoRAE 2 Cradle's configuration data (a progress bar is shown during downloading).

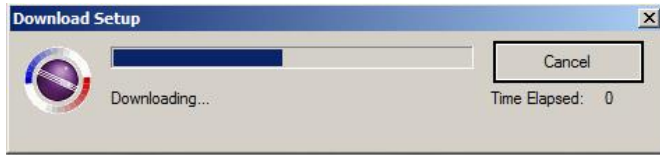

The AutoRAE 2 Cradle's data is shown, including its Model Number and Serial Number:

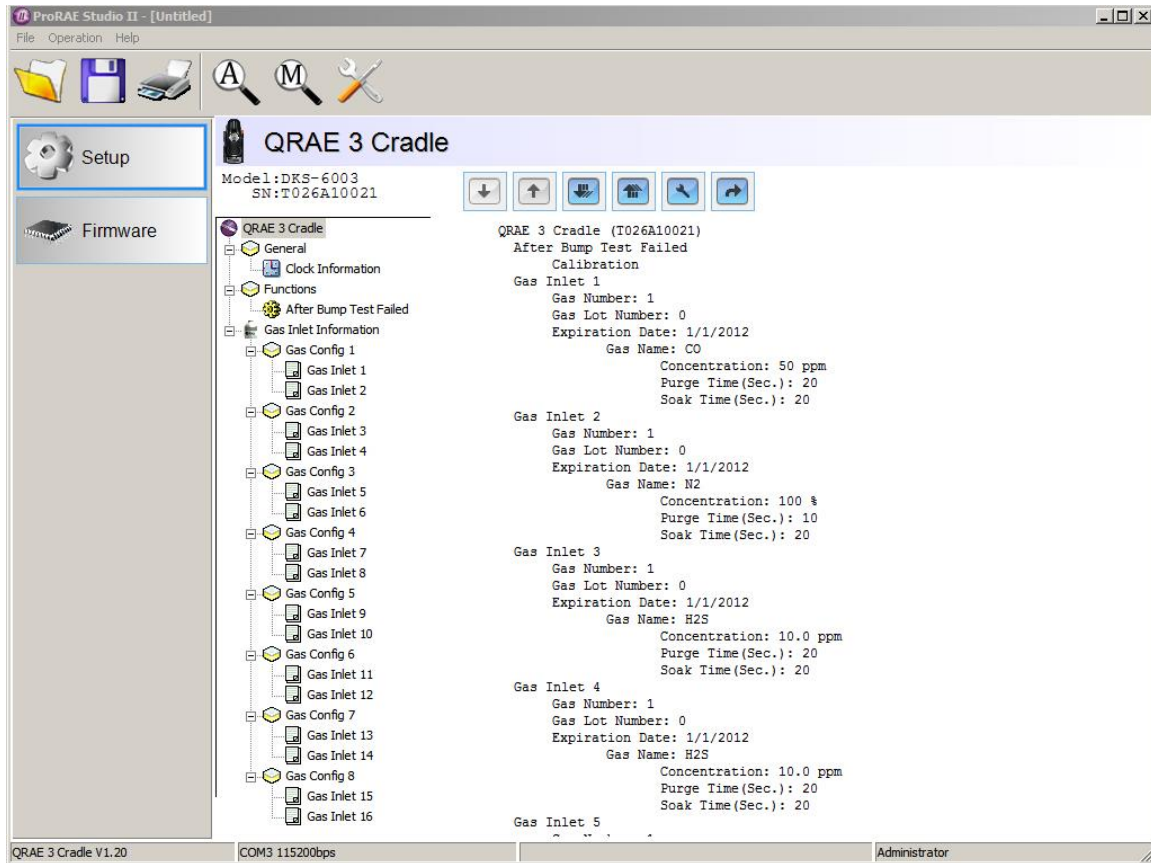

Click "Clock Information" to check or set the date and time:

AutoRAE 2 User's Guide

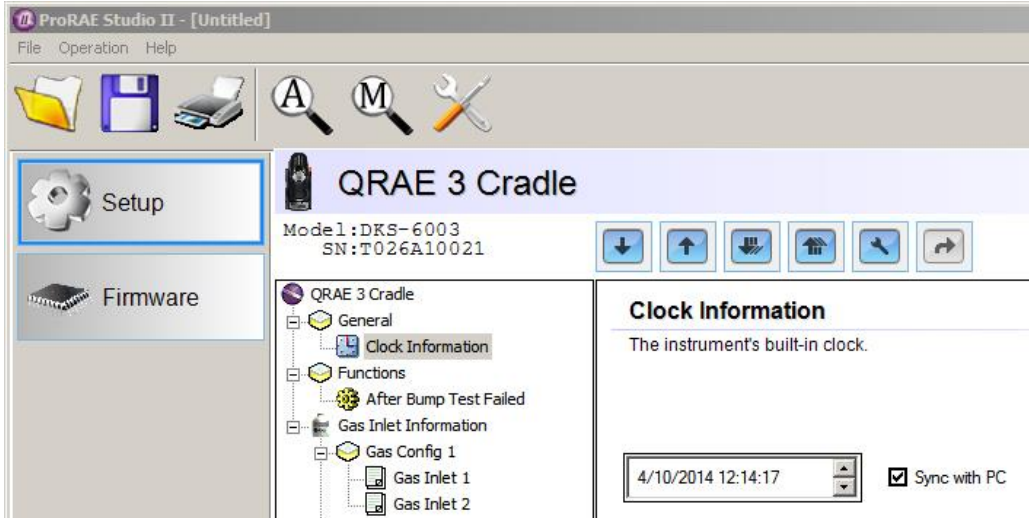

If you want to synchronize the date and time on the AutoRAE 2 Cradle with the time on the PC, click the box labeled “Sync with PC.”

AutoRAE 2 User's Guide

12.1. Gas Inlet Configuration Settings

“Gas Bottle Information” tells the AutoRAE 2 what kind of gas is supplied to each gas inlet. The “Gas Bottle Information” section includes configuration parameter settings for the two AutoRAE 2 Cradle gas inlets including gas types, concentrations, concentration units, purge time, and soak time for gas cylinders connected to each gas inlet. You can modify these values and upload them to your AutoRAE 2 Cradle(s) or download the values currently programmed into the Cradle to ProRAE Studio II.

There are eight gas configurations (“Gas Config”), of which only Gas Config 8 is used. Gas Config 8 corresponds to code G8 displayed on the cradle LED display.

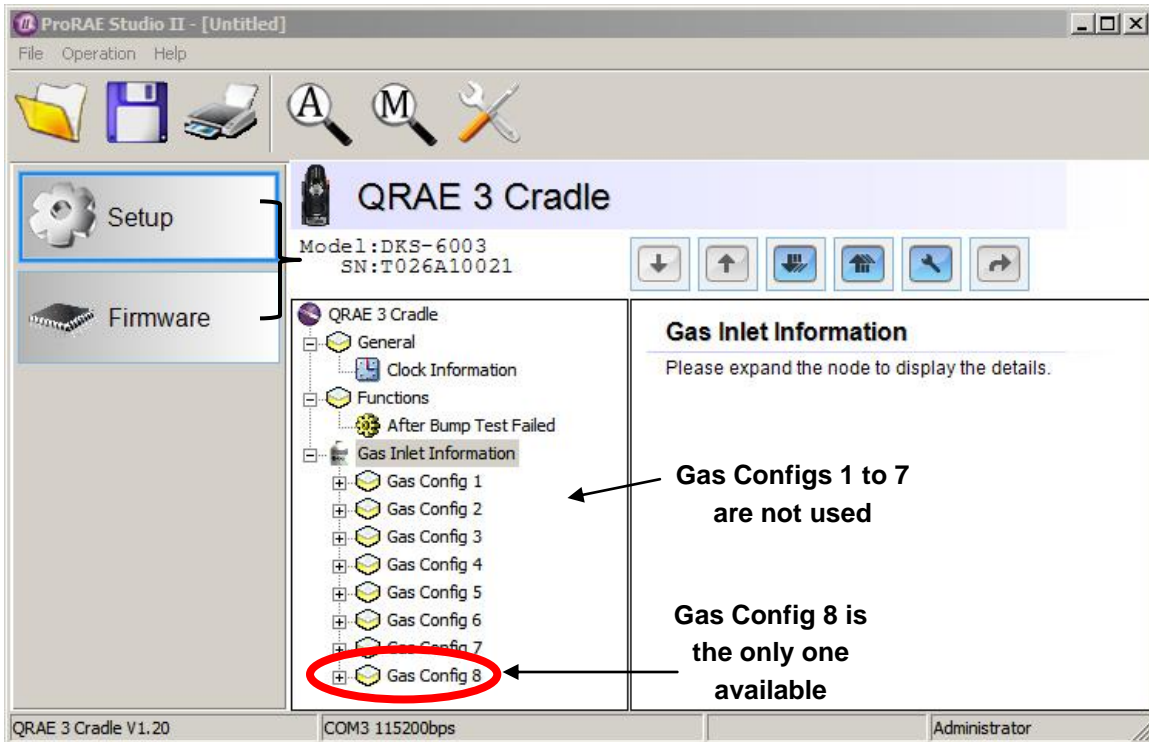
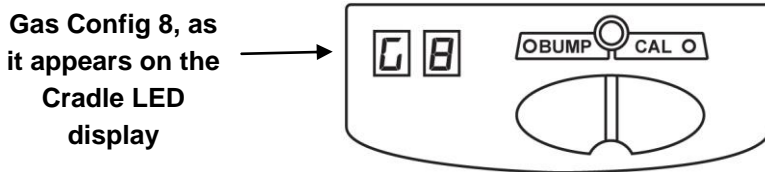

AutoRAE 2 User's Guide

When you click on Gas Config 8, the two gas bottles (Gas Inlet 15 and Gas Inlet 16) are shown:

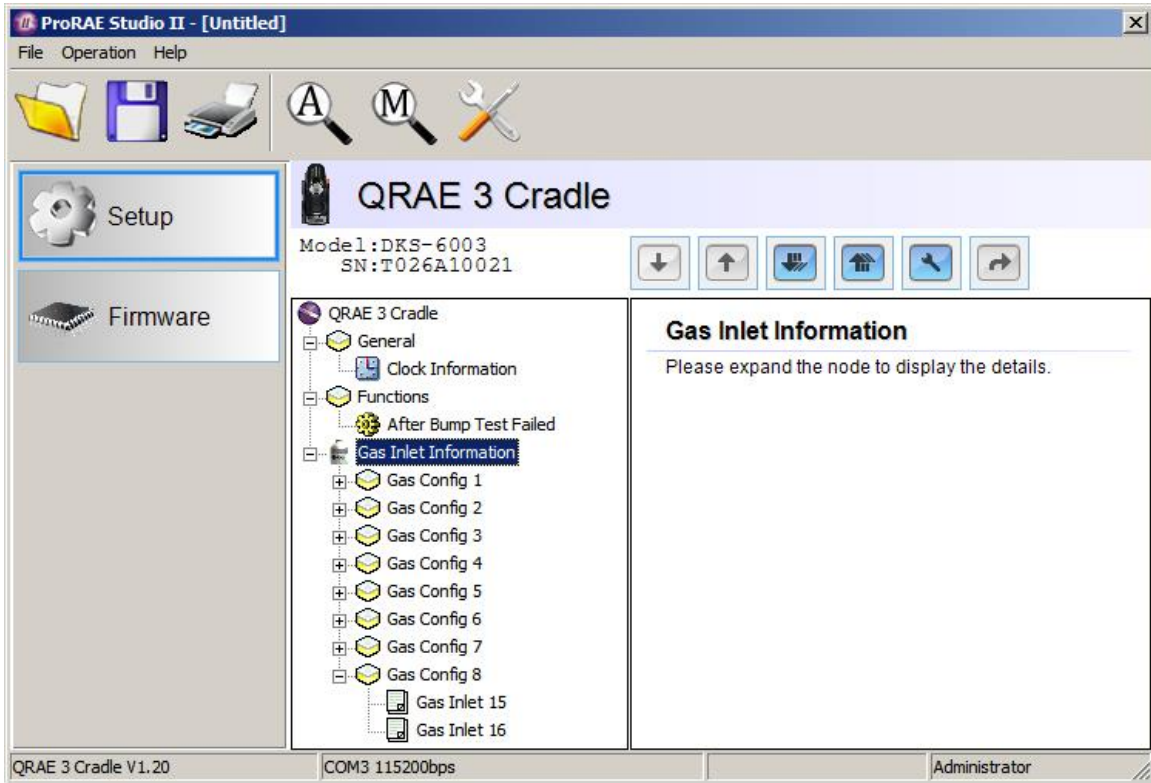

AutoRAE 2 User's Guide

Gas Config 8 covers settings for two cylinders of gas – Gas Bottle 15 and Gas Bottle 16. Gas Bottle 15 and Gas Bottle 16 correspond to gas inlets 1 and 2, respectively, on the side of the AutoRAE 2 Cradle.

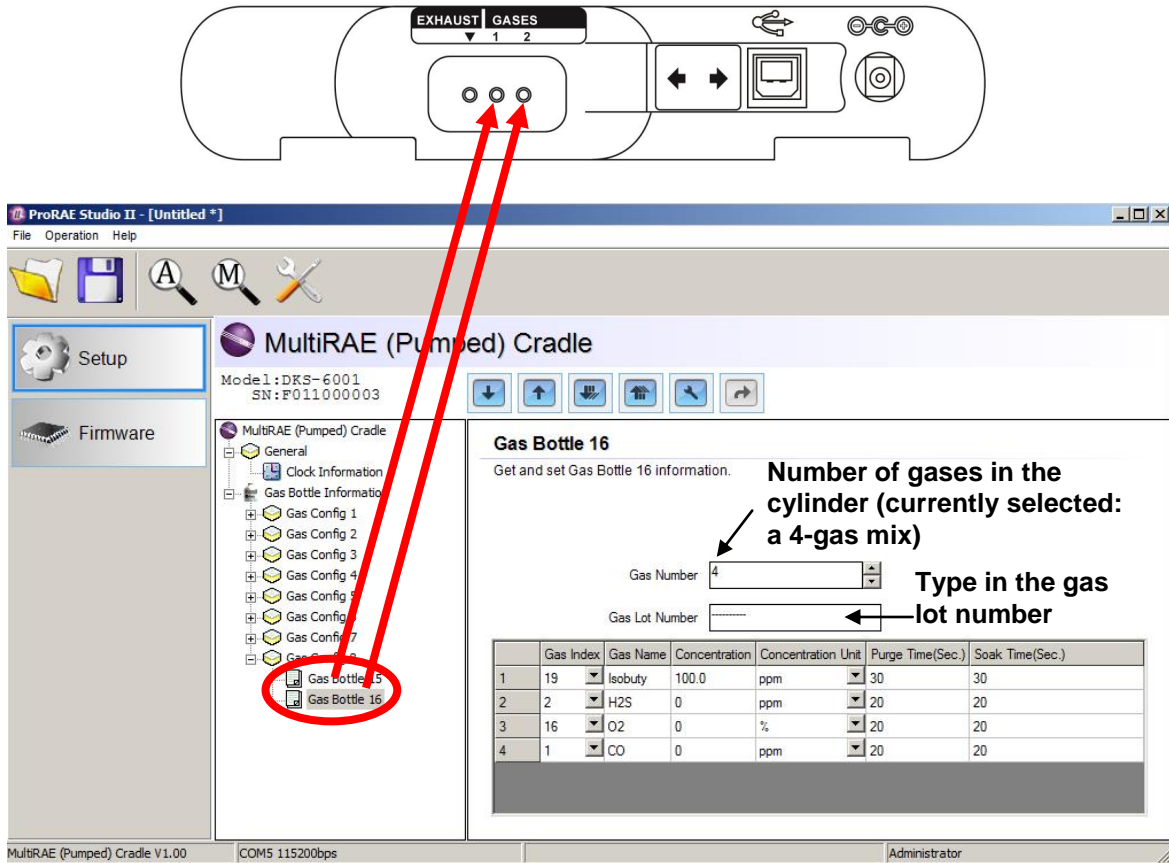

Select a Gas Bottle under Gas Config 8. The window now shows the selected Gas Bottle (Gas Bottle 16 shown), its Gas Number (number of gases in the gas mix, if the bottle contains more than one gas; 4-gas mix shown), Gas Lot Number, and data that includes Gas Index, Gas Name, Concentration, Concentration Unit, Purge Time (Sec.), and Soak Time (Sec.).

Note: Gas Configs 1 to 7 cannot be used. Gas Config 8 is the only configuration available.

12.2. Selectable Gas Index Values For Gas Config 8

You can use the pull-down menus to select Gas Index values for the two bottles (Gas Bottle 15 or Gas Bottle 16) to be used for Gas Config 8.

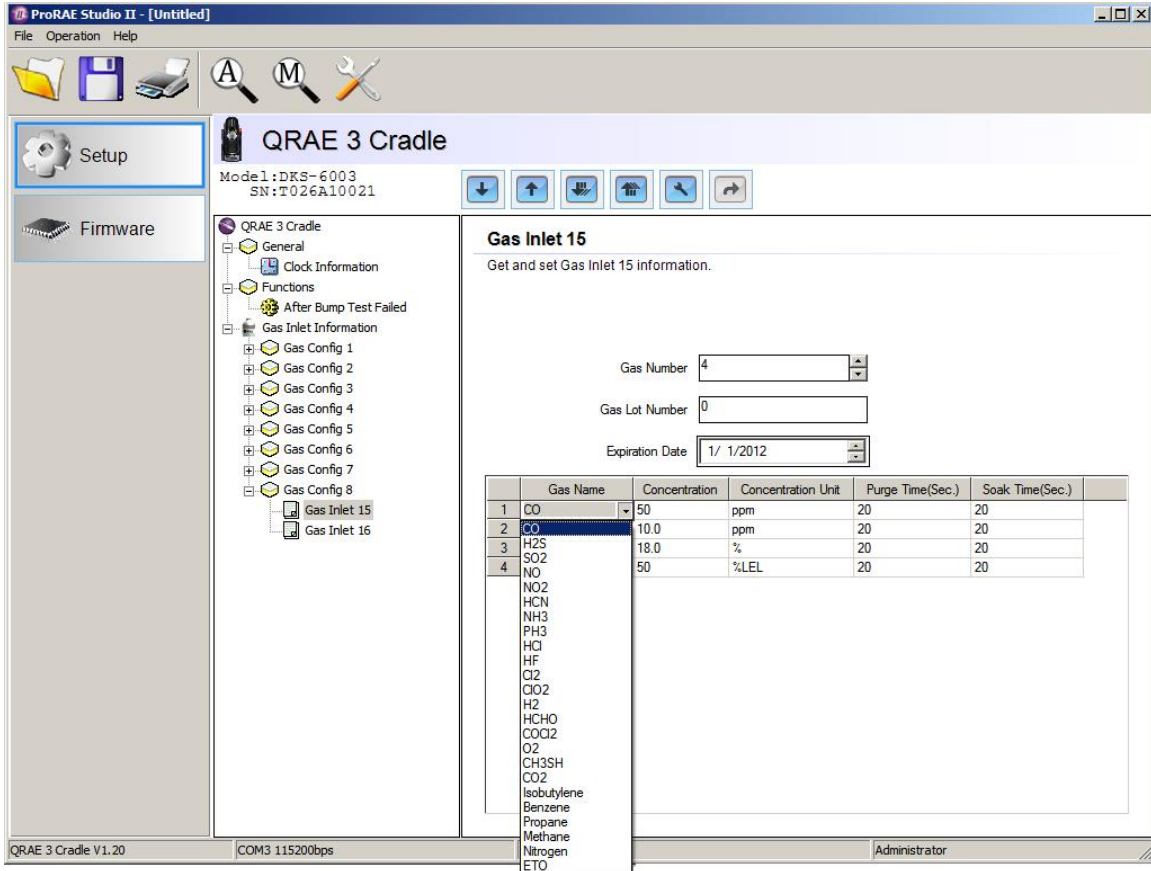

Supported gases include:

1 - CO	9 - HCl	17 - CH ₃ SH
2 - H ₂ S	10 - HF	18 - CO ₂
3 - SO ₂	11 - Cl ₂	19 - Isobutylene
4 - NO	12 - ClO ₂	20 - Benzene
5 - NO ₂	13 - H ₂	21 - Propane
6 - HCN	14 - HCHO	22 - Methane
7 - NH ₃	15 - COCl ₂	23 - Nitrogen
8 - PH ₃	16 - O ₂	24 - ETO

Note: The currently selected Gas Index (and name) is highlighted. Use the scroll bar to select the desired gas.

12.3. Gas Name

When you change the Gas Index number and then click elsewhere in the table, the Gas Name is updated automatically to the gas name corresponding to the selected Gas Index.

12.4. Concentration [Value]

You can set the concentration by double-clicking in the respective gas concentration box and then typing in the concentration value.

12.5. Concentration Unit

When you pull down the Concentration Unit menu, select the desired gas concentration units (there are other types of units).

- ppm
- %
- ppb
- mg
- ug
- %LEL
- %VOL
- %CH₄

12.6. Purge Time (Sec.)

Type to set the number of seconds for the system to purge with fresh air after performing a bump test or calibration.

12.7. Soak Time (Sec.)

Type to set the number of seconds for the system to allow the sensor to be pre-exposed to calibration gas before bumping or calibrating.

12.8. Uploading Settings To The AutoRAE 2 Cradle

1. When you are done setting the Gas Configs, upload them to the AutoRAE 2 cradle by clicking on the “Upload all settings to the instrument” icon:



2. A dialog box appears:

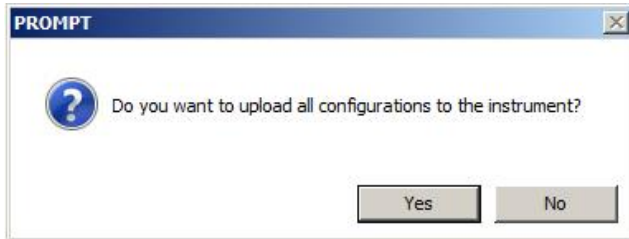

- Click “No” if you do not want to upload the configurations.
- Click “Yes” to upload the configurations.

3. During the upload process, a progress bar is shown:

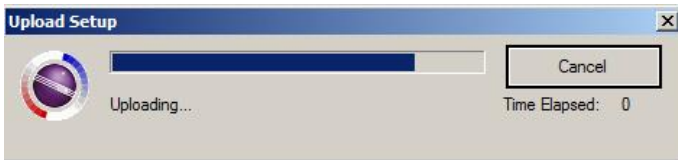

12.9. Downloading & Uploading Individual Gas Inlet Settings

If you only want to download a single set of Gas Inlet settings from the Cradle, click the name (Gas Inlet 4, for example), and then click the “Get Current Content Settings” button:



If you want to upload a single set of Gas Bottle settings to the Cradle, click the name (Gas Inlet 4, for example), and then click the “Set Current Content Settings” button:



12.10. Saving The Settings File

If you want to save the settings for backup or for use later, click the “Save Current Data” button and then save the file. The file has a “.prs” extension (a ProRAE Studio II file).

AutoRAE 2 User's Guide

12.11. Recalling Stored Settings

If you have previously stored settings in a separate file, you can call them up so that you can modify them and/or apply them to AutoRAE 2 Cradles. This feature is especially useful if you have multiple individual Cradles to which similar settings need to be populated.

1. Click the “Open A Saved File” (folder) icon.
2. Find the ProRAE Studio configuration file you want to upload from your PC (it will have a .prs suffix).
3. Click “Open.”

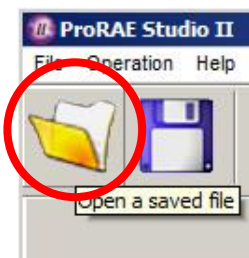

Note: Opening a file overwrites any settings (modified or unmodified) already in the active ProRAE Studio II session.

You may now modify or upload these settings.

12.12. Uploading Settings To Multiple AutoRAE 2 Cradles

You can apply settings to multiple cradles. Simply connect one cradle to the PC and upload the settings as outlined in the previous section, disconnect that cradle, connect another, and then upload settings.

12.13. Exiting Programming

When you are done programming and have saved the settings, do the following:

1. Exit ProRAE Studio II.
2. Disconnect the USB cable between the PC and the AutoRAE 2 Cradle.
3. Press the “Bump” key on the AutoRAE 2 Cradle (the display changes from “PC” to the active gas configuration, G8).

13. Upgrading Firmware On The AutoRAE 2 Cradle

Upgrades to a stand-alone AutoRAE 2 Cradle's firmware can be loaded into the AutoRAE 2 Cradle using ProRAE Studio II software running on a PC. If the Cradle (or multiple Cradles) is attached to an AutoRAE 2 Controller, follow the AutoRAE 2 Controller Firmware Upgrade instructions on page 99.

1. Download firmware from the RAE Systems web site or from a CD-ROM.
2. Connect a PC running ProRAE Studio II to the AutoRAE 2 Cradle via a USB cable.
3. Press and hold the Bump key until "PC" appears in the display.
4. Start ProRAE Studio II.



5. Click "Administrator."

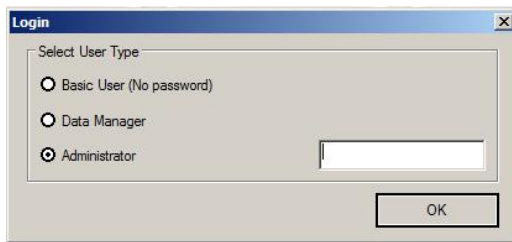

6. Enter the password (the default is "rae").

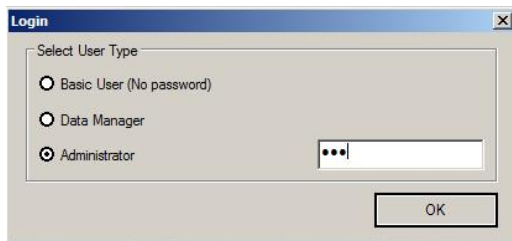

7. Click "OK."
8. Click "Detect the instruments automatically."



AutoRAE 2 User's Guide

9. Select the AutoRAE 2 Cradle.

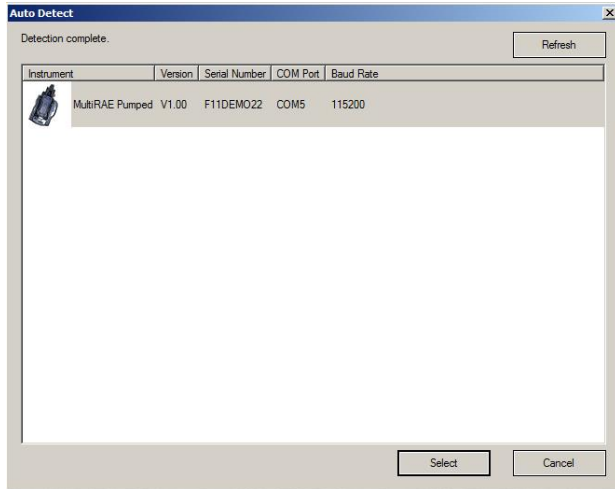

10. Click "Select."

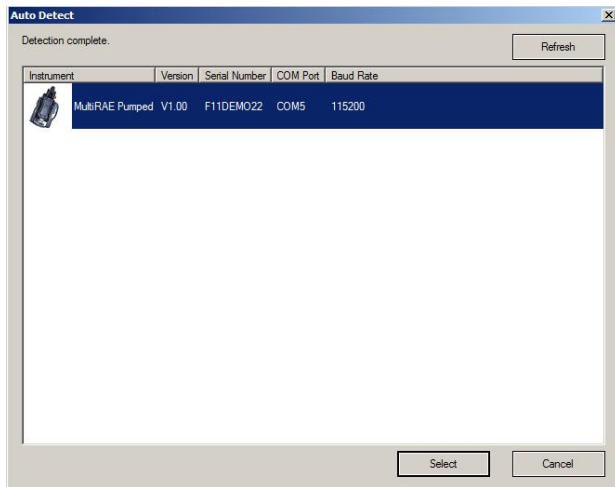

11. The three options on the left are "Setup," "Firmware," and "Tool." Click "Firmware."



AutoRAE 2 User's Guide

- Click “Run Programmer.”



The RAE Programmer 4000 window opens:

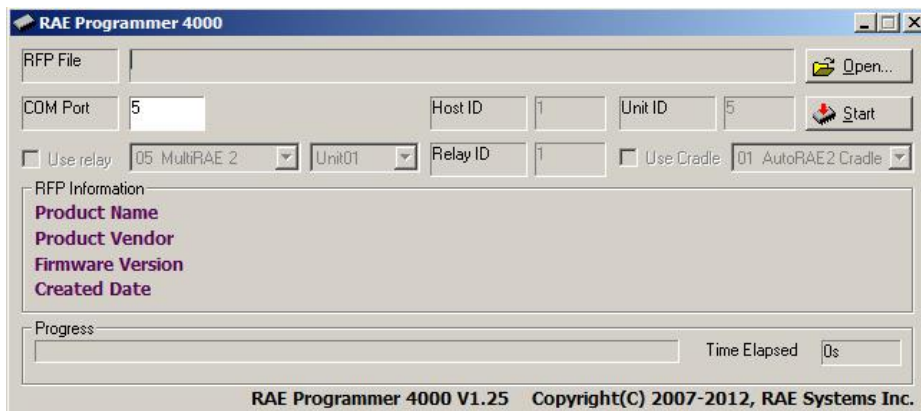

- Click the button that says, “Open...”

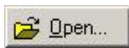

- Find and select the firmware file with a “.rfp” extension.



- Click “Open.”

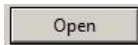

- Click “Start.”



- The firmware is uploaded to the AutoRAE 2 Cradle.
- Exit PC Communications mode on the AutoRAE 2 Cradle by pressing “Bump.” The display should now show “G8.”
- Exit ProRAE Studio II on the PC.
- Disconnect the USB cable.

14. Using A Stand-Alone AutoRAE 2 Cradle For Datalog Transfer, Monitor Configuration, and Firmware Upgrades

Datalogs can be downloaded from an instrument to a computer, and firmware updates and configuration data can be uploaded to an instrument via the USB port on a stand-alone AutoRAE 2 Cradle. Use the included USB cable to connect the AutoRAE 2 Cradle to a computer running ProRAE Studio II (version 1.10.0 or higher). Follow the instructions in the ProRAE Studio II User's Guide.

AUTORAE 2 CONTROLLER-BASED SYSTEM

15. Overview

The AutoRAE 2 Controller turns the AutoRAE 2 into a powerful, networked docking station that can support up to 10 monitors at a time and accommodate up to five distinct gas sources for multi-sensor calibration and bump testing.

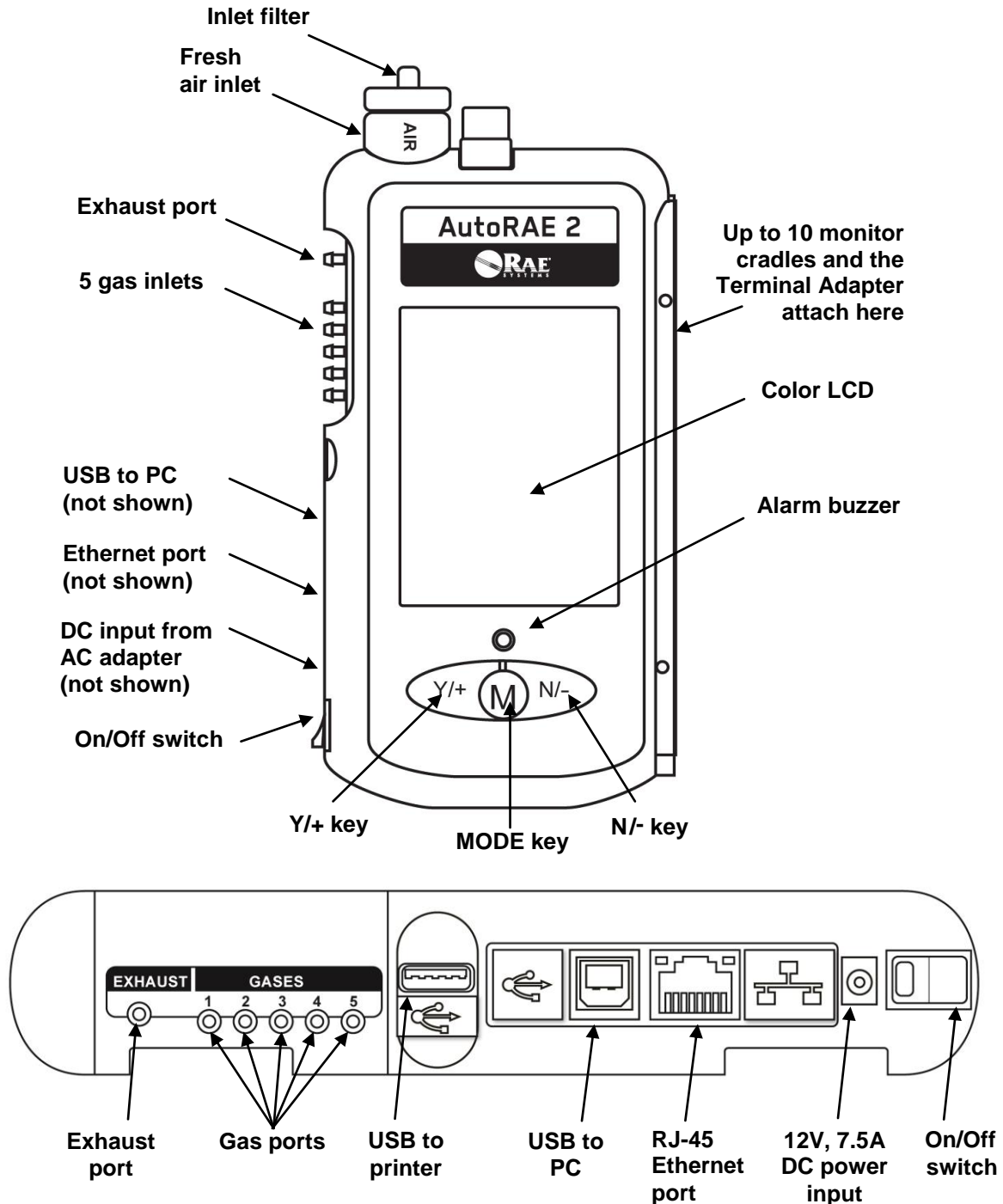

AutoRAE 2 User's Guide

The AutoRAE 2 Controller has sliding covers to protect its USB and Ethernet ports from contamination when they are not in use. Simply slide their respective covers over them.

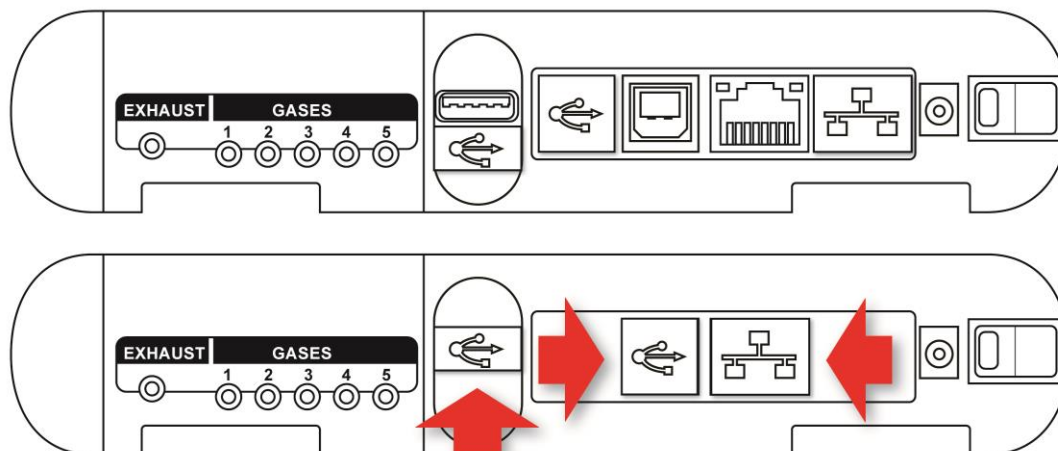

15.1. Standard Package Contents

The AutoRAE 2 Controller (P/N T02-0107-000) is shipped with the following:

- AutoRAE 2 Controller
- AutoRAE 2 Terminal Adapter
- PC Communications Cable, USB Type A (Male) to Type B (Male), P/N 410-0086-000
- 12-volt, 7.5A power supply (P/N 500-0141-000) with:
 - US (P/N 410-0036-000),
 - UK (P/N 410-0036-004), and
 - European (P/N 410-0036-005) power cords
- External inlet filters: 1 installed, three spare (P/N 008-3022-003, pack of 3)
- Tygon tubing (1/8" I.D., 15mm long), pack of 5, P/N 411-0018-037-05
- SD memory card - 2GB, P/N 550-0300-000
- Quick Start Guide, P/N T02-4002-000
- AutoRAE 2 Resource CD-ROM, P/N T02-4012-000
 - This disc includes:
 - User's Guide
 - QuickStart Guide
- ProRAE Studio II Instrument Configuration and Data Management Software CD-ROM, P/N 000-5007-001
- Product registration card
- Quality inspection and test certificate

16. Operation of an AutoRAE 2 Controller-based System

Deploying AutoRAE 2 Cradles with the AutoRAE 2 Controller significantly enhances the system's capabilities compared to those of a standalone cradle. An AutoRAE 2 Controller-based system can charge, test, and calibrate up to 10 instruments at the same time using up to 5 distinct gas inputs. The system supports USB printers (with HP Printer Command Language 5 or 5E) for direct printing, and has a standard SD card on which data are stored.

When one or more AutoRAE 2 Cradles are attached to the AutoRAE 2 Controller, the AutoRAE 2 controller acts as the "command center" for the system. The Controller powers the entire system, manages all the configuration settings, and its built-in pump and valves control the gas flow.

Note: An AutoRAE 2 Terminal Adapter must be attached to the rightmost cradle in order for an AutoRAE 2 Controller-based system to work.

IMPORTANT!

Before using the AutoRAE 2 Controller, it must be configured using ProRAE Studio II software to set the gas types and concentrations, as well as the time and date. See page 88 for details.

17. Setting Up an AutoRAE 2 Controller-based System

A single AutoRAE 2 Controller can connect with up to 10 AutoRAE 2 Cradles (these can be all of one kind, or mixed types). The Terminal Adapter must be connected to the final (rightmost) AutoRAE 2 Cradle.

To assemble an AutoRAE 2 Controller-Based System, slide an AutoRAE 2 Cradle snugly against the AutoRAE 2 Controller. If you have more than one AutoRAE 2 Cradle, slide each one against the other, until all are held snugly. Then slide the Terminal Adapter against the last one. Press them all into place once more, and then insert the Philips screws that hold the units securely together.

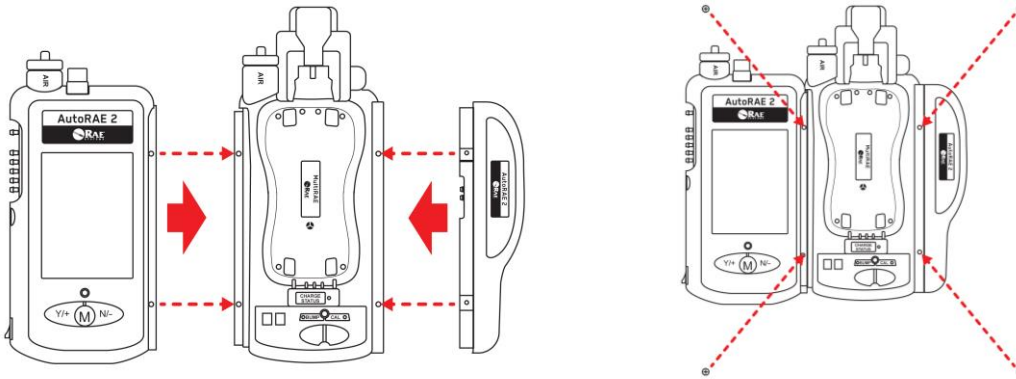

Tighten all of the Philips screws, and then press the black plastic caps over them.

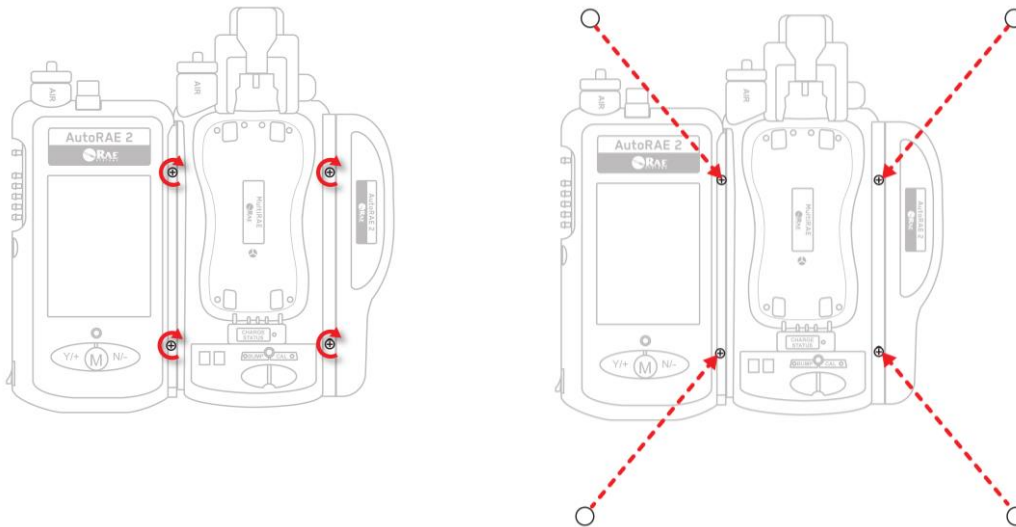

AutoRAE 2 User's Guide

17.1. Installing Batteries For The Real-Time Clock

The AutoRAE 2 Controller has an internal real-time clock (RTC), which is set via ProRAE Studio II. A small button cell is soldered to the main board to keep the clock running when power is removed from the system (it is recharged when power is connected). In addition, three AA replaceable batteries in the AutoRAE 2 Controller maintain the last calibration record in the event that it is not written to the SD card.

1. Make sure the AutoRAE 2 Controller is turned off and the AC adapter disconnected.
2. Remove the two Phillips-head screws that secure the battery compartment cover.
3. Remove the battery compartment cover.
4. Insert three AA batteries (alkaline or lithium), paying attention to their polarity.
5. Replace the cover.

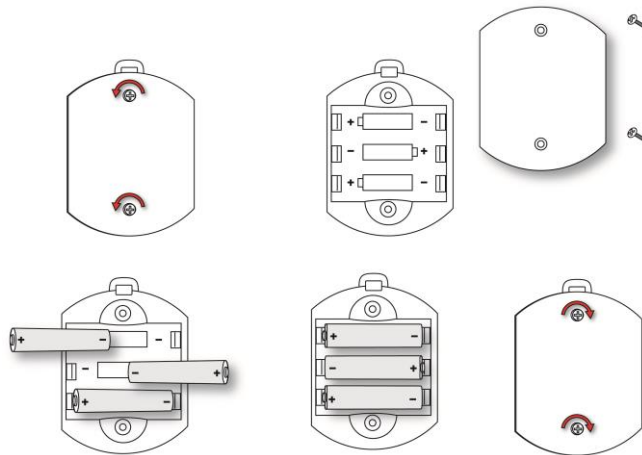

17.2. Attaching An External Filter

In order to ensure that fresh air is uncontaminated by dust or other materials, use a filter on the AutoRAE 2 Controller's fresh air inlet. The inlet is located at the top end on the left side. Inspect the filter periodically and replace it as necessary if it is dirty, damaged, or contaminated.

AutoRAE 2 Controller – top view

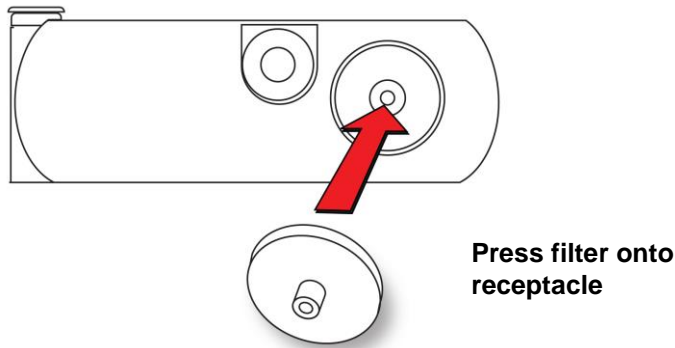

17.2.1. Active Carbon Filter For Removing VOC

Whether zeroing the ppbRAE 3000 or in an environment in which the ambient air has VOC (volatile organic compounds), you can use an Active Carbon Filter (P/N: 490-0006-000), which filters out VOC from the air. When an AutoRAE Controller is used with one or more Cradles, the air inlet on each attached cradle is disabled and air is taken in through the Controller's air inlet. Therefore, you only need to use one Active Carbon Filter for the Controller instead of on each cradle. To install the Active Carbon Filter on the cradle:

1. Remove the standard filter (if one is installed).
2. Remove the plastic filter adapter by twisting the plastic filter clockwise while gently pulling outward.
3. Press the Active Carbon Filter into the receptacle. The filter is designed for 20 uses. To help you keep track of how many calibrations are performed, there are 20 small boxes painted on the surface of the filter that you can mark with a pen after each use. **Note:** Make sure the arrow on the side of the filter points toward the cradle.

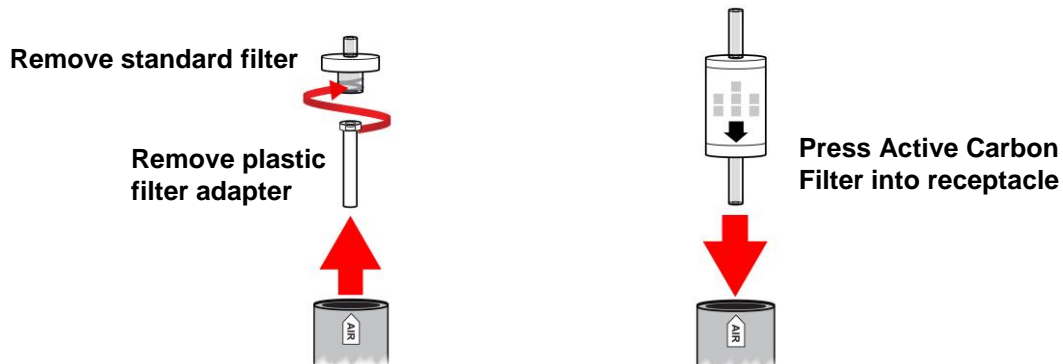

18. Powering an AutoRAE 2 Controller-Based System

An AutoRAE 2 Controller-based system is powered by its 12V, 7.5A AC adapter. The jack for the AC adapter connection is in the recess on the left side of the AutoRAE 2 Controller, next to the power on/off switch. Plug the barrel end of the AC adapter into the AutoRAE 2 and the transformer into an AC outlet.

Caution: Never use the AutoRAE 2 Controller or its AC adapter in wet or damp environments or hazardous locations.

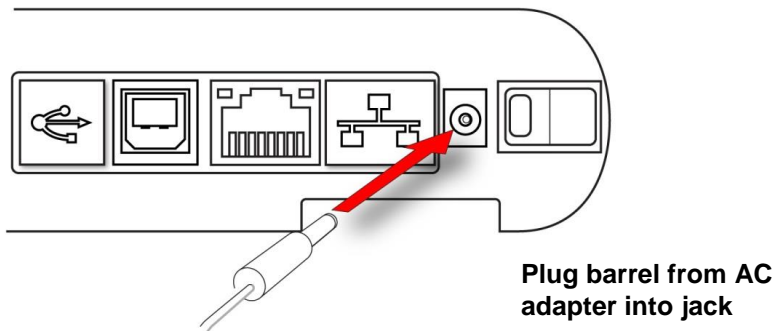

19. Operating A Controller And Attached Cradles

When An AutoRAE 2 Controller is attached to one or more AutoRAE 2 Cradles, the buttons on the AutoRAE 2 Cradles are only used to initiate a bump test or calibration. The two-character LED displays on each Cradle show the ID number for the respective Cradle. All operations and settings are controlled by the AutoRAE 2 Controller.

19.1. Turning The AutoRAE 2 Controller On

Toggle the switch on the side of the AutoRAE 2 Controller. The LCD display turns on and the LED on the on/off switch glows red. The system performs a self-test, covering the AutoRAE 2's internal pump and valves, Terminal Adapter, gas pressure in connected cylinders, and other vital components and parameters. As each cradle is powered up, its Bump and Cal LEDs turn on momentarily and the two-character LED display lights up showing the Cradle ID number in the system.

19.2. Turning The AutoRAE 2 Controller Off

Toggle the switch on the side of the AutoRAE 2 Controller. The display and power LED go dark, as do all the LEDs on attached cradles.

19.3. Startup Routine

When you turn on the system, the AutoRAE 2 Controller's display shows this screen:

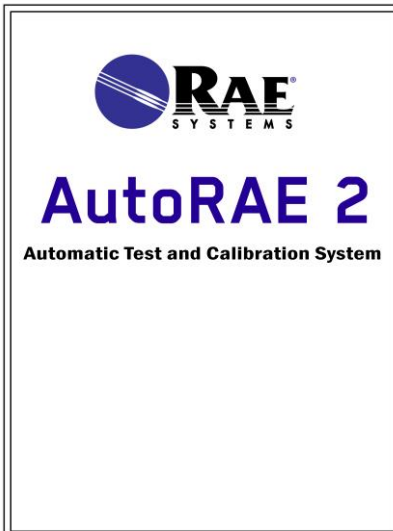

It then goes through a series of tests and shows several screens, including configuration information for the five gas inlets.

AutoRAE 2 User's Guide

If the system's initial checkout passes, then this screen is displayed:

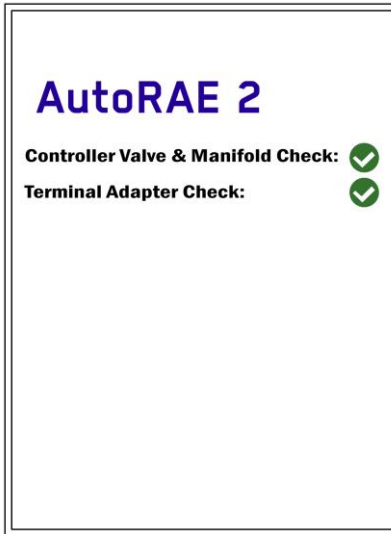

If either or both mechanical tests fail, then a red square with an "X" in it indicates the problem:

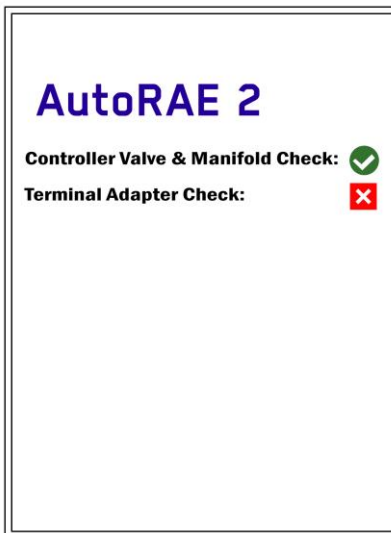

If the Controller Valve & Manifold Check fails, you should turn off the system and contact RAE Systems Technical Support.

If the Terminal Adapter Check fails, make sure the Terminal Adapter is connected to the last AutoRAE 2 Cradle, and that all of the AutoRAE Cradles in the system are firmly connected. Try restarting the system. If everything is connected but the test fails again, contact RAE Systems Technical Support.

AutoRAE 2 User's Guide

If all tests pass, then this screen is displayed, indicating that the AutoRAE 2 system is ready for use:

Cradle	Instrument	Status
▶ 1	No Instrument	
2	No Instrument	
3	No Instrument	
4	No Instrument	

Function More Info ↓

If there are instruments in the cradles, their warm-up process starts automatically as soon as their respective cradle has been powered up and identified by the AutoRAE 2 Controller.

19.4. User Interface

All functions and configurations are initiated by using the three buttons on the Controller, [Y/+], [MODE], and [N/-]:

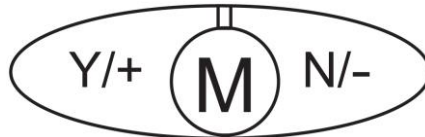

“Soft keys” are shown on the display, and the AutoRAE 2 Controller’s buttons correspond to soft keys directly above them. For example:

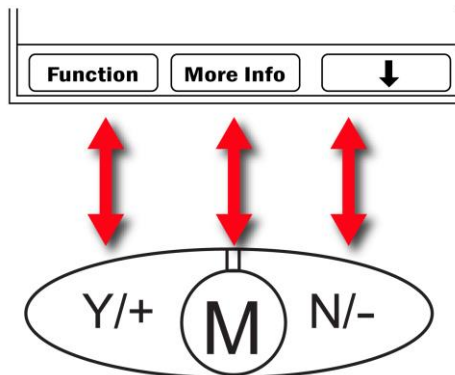

AutoRAE 2 User's Guide

19.5. Display Status Messages and Color Coding

The AutoRAE 2 Controller has a color display, so colors are used to indicate status in different categories of information.

Status	Color	Explanation
Pass	Green	1. All sensors and alarms passed bump test. 2. All sensors and alarms passed calibration.
Pass?	Green	1. All sensors that were tested passed bump test. Some sensors were not tested. 2. All sensors that were calibrated passed calibration. Some sensors were not calibrated.
Fail	Red	1. One or more sensors or alarms failed bump test. 2. One or more sensors or alarms failed calibration. 3. Monitor not detected after 30 minutes. 4. Monitor warm-up error or other error.
Warning	Yellow	Sensor does not match the gas.
Warm-up	None	Instrument warm-up.
Ready	None	Instrument ready to bump test or calibrate.

19.6. Warm-Up

When you place a monitor in the Cradle and lock the capture mechanisms, the system automatically starts charging the instrument and initiates a warm-up cycle to prepare the instruments for use with AutoRAE 2. In order for the warm-up cycle to commence, however, the monitors need to be either turned off or in AutoRAE 2 Communications mode.

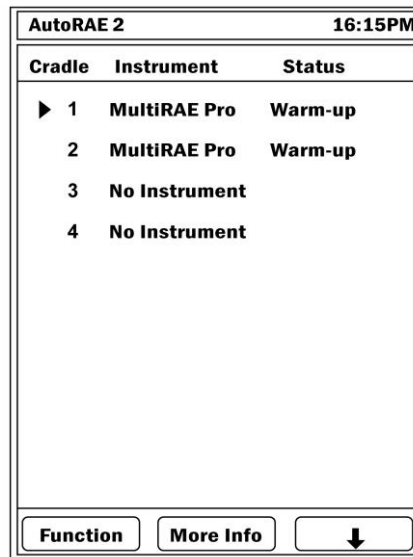

The screenshot shows the AutoRAE 2 display interface. At the top, it reads "AutoRAE 2" on the left and "16:15PM" on the right. Below this is a table with three columns: "Cradle", "Instrument", and "Status". The table contains four rows of data:

Cradle	Instrument	Status
▶ 1	MultiRAE Pro	Warm-up
2	MultiRAE Pro	Warm-up
3	No Instrument	
4	No Instrument	

At the bottom of the display, there are three buttons: "Function", "More Info", and a downward-pointing arrow button.

The warm-up time depends on the sensors installed in the instrument and their individual warm-up requirements. During warm-up, the two Cradle LEDs labeled "Bump" and "Cal" blink orange in alternation and the instrument's name in the AutoRAE 2 Controller's display is accompanied by "Warm-up." When an instrument is warmed up,

AutoRAE 2 User's Guide

the two LEDs glow continuously green, and the AutoRAE 2 Controller's display shows the word "Ready" next to the instrument name without highlighting. (**Note:** If there is a sensor mismatch, the name will be highlighted in yellow.) This indicates that you may now perform a bump test or calibration.

If the instrument fails to warm up, the Cradle's Bump and Cal LED lights will blink red in alternation and the buzzer will alarm. The AutoRAE 2 Controller's display highlights the instrument in red with the word "Error." Remove the monitor from the cradle and refer to the information on the instrument display.

19.7. Testing

When the AutoRAE 2 Controller is turned on, it performs a self-test, SD card checks (whether an SD card is present, whether it is full or nearing full capacity, etc.), a test of each attached AutoRAE 2 Cradle, and then a test of any instruments that are in the cradles. Bump testing and calibration can only take place on an instrument if its tests are passed, including compatibility between the gas settings in the AutoRAE 2 Controller and the instrument.

19.7.1. Compatibility Testing

The AutoRAE 2 Controller checks that the gas settings programmed into the AutoRAE 2 Controller match the settings in the instrument for each sensor and its calibration gas. If there is a mismatch, the "Status" column on the display shows "Warning." Press [N/-] to scroll to the instrument in the list that you want to read details on. Press [MODE] to get more info:

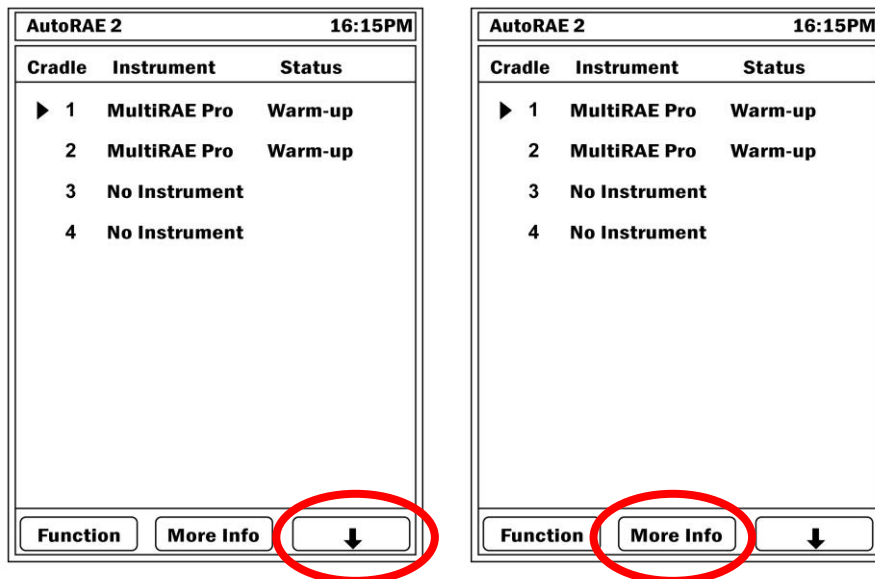

AutoRAE 2 User's Guide

Information is available that describes the detected problem:

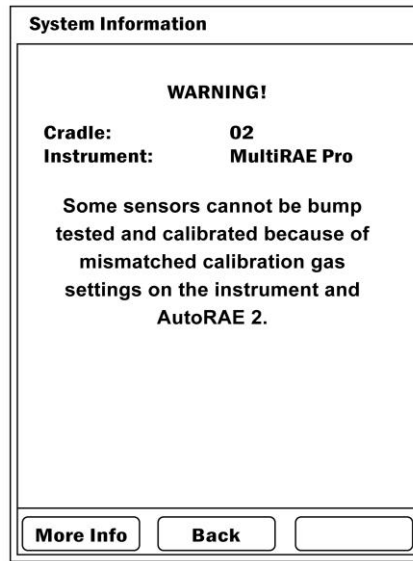

If there is a mismatch, check the instrument's settings in Programming Mode, as well as the settings programmed for the AutoRAE 2 via ProRAE Studio II.

If all instruments in the cradles warm up and all test without errors or incompatibilities, then they are listed as "Ready":

AutoRAE 2		16:15PM
Cradle	Instrument	Status
▶ 1	MultiRAE Pro	Ready
2	MultiRAE Pro	Ready
3	MultiRAE Pro	Ready
4	MultiRAE Pro	Ready
5	MultiRAE Pro	Ready
6	MultiRAE Pro	Ready
7	MultiRAE Pro	Ready
8	MultiRAE Pro	Ready
9	MultiRAE Pro	Ready
10	MultiRAE Pro	Ready

At the bottom of the table, there are three buttons: "Function", "More Info", and a button with a downward arrow.

20. Preparing For Bump Testing & Calibration

Before performing a bump test or calibration, the AutoRAE 2 must be set up (refer to Section 16 for details), have an SD card with sufficient available memory in it, power applied, and calibration cylinders connected.

20.1. SD Memory Card

The AutoRAE 2 Controller electronically stores system files and reports on a standard SD memory card, as well as system-specific data.

IMPORTANT!

The 2GB SD card that comes with the AutoRAE 2 Controller is pre-formatted and ready for use (RAE Systems P/N 550-0300-000). If you purchase an SD card from another vendor, it can be greater than 2GB, but only 2GB of space will be used by the AutoRAE 2 Controller.

Note: The SD card inside AutoRAE 2 can only be used for AutoRAE 2 recording. Do not save other files to the SD card.

Although a 2GB SD card can hold approximately 3 years' worth of daily bump, calibration, or combined data for 500 instruments, transferring reports from the SD card to a PC every 6 months is recommended. This enhances data security and speeds the data-transfer process.

IMPORTANT!

The AutoRAE 2 cannot operate without an SD card in its slot.

Note: If no SD card is in the slot when the AutoRAE 2 Controller is turned on, or the SD is locked, or if the SD card is removed during operation, the display shows this message:

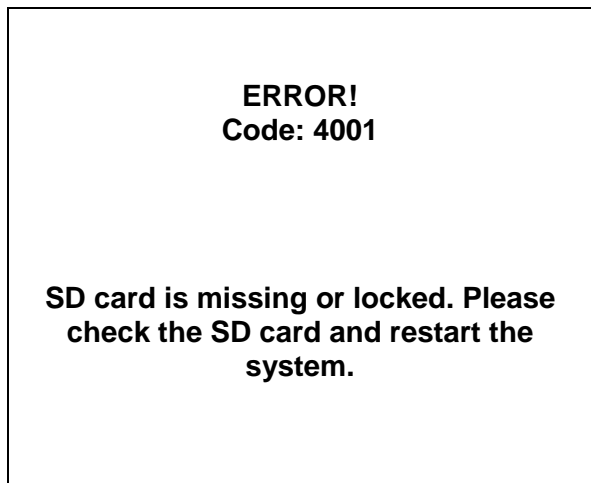

AutoRAE 2 User's Guide

CAUTION!

Do not remove the SD card from its slot or insert an SD card into an empty slot while the AutoRAE 2 Controller is running. This may damage the SD card or corrupt its data.

If the SD card is locked, the error message shown above is displayed. The AutoRAE 2 Controller cannot write data to a locked SD card. Remove the SD card and unlock it by moving the lock tab upward; then reinsert the SD card.

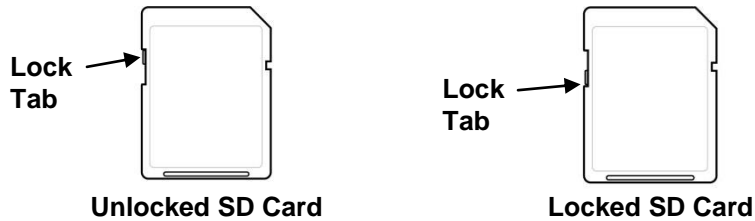

If remaining space for data on the SD card is very low, the display shows the message “SD card running low on space.” If the SD card is full, an error message appears on the display that says: “SD card full.” Replace the SD card with another with more space on it, or offload the data to a computer. Then erase the data from the card, using your computer, and reinsert the SD card back into the AutoRAE 2.

IMPORTANT!

Keep the SD card port cover closed whenever an SD card is not being inserted or removed. This helps to keep the reading mechanism and the SD card clean, especially in dusty environments.

AutoRAE 2 User's Guide

20.1.1. Installing An SD Card

1. Use a 2.0-size hex wrench to loosen and remove the screw holding the cover on the SD card port.
2. Slide the door down so that the port is visible.
3. Press the SD card into the slot with the angled notch on the right. Press until it locks into place, making a “click” sound. Slide the door up to cover the port.
4. Insert and tighten the screw.

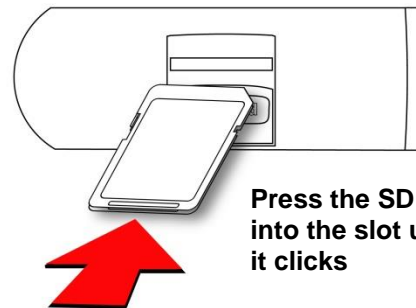
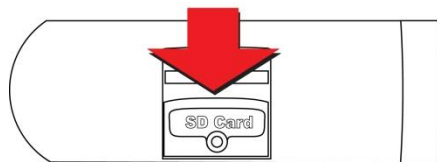
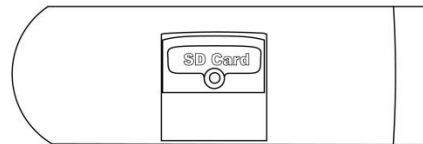
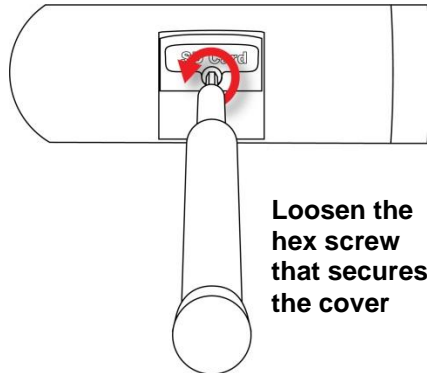

20.1.2. Removing An SD Card

To remove an SD card, press in on it until it makes a click and pushes part of the way out of the slot. Then pull it out with your fingers.

20.2. Connecting Calibration Gas

Connect cylinders of calibration gas to the inlet ports labeled “Gases” on the left side of the AutoRAE 2 Controller. Make sure that they are connected to the correct inlet, as defined in Gas Bottle settings described in Section 21.1.

All gas connections are barbed to secure the hoses to them. Appropriately non-reactive/non-adsorptive tubing with a 1/8" I.D. should be used (Teflon for PID or corrosive or reactive gases, Tygon for others). The cylinders must have demand-flow regulators (0 to 1,000 psig/70 bar) installed.

IMPORTANT!

Always check that the Gas Bottle configuration for each inlet on the AutoRAE 2 Controller matches the type/concentration of the actual calibration gas connected to it before you begin any bump test or calibration. Also, make sure the calibration gas is not past its due date.

Note: When a cylinder of gas is empty, or has low pressure, it should be replaced.

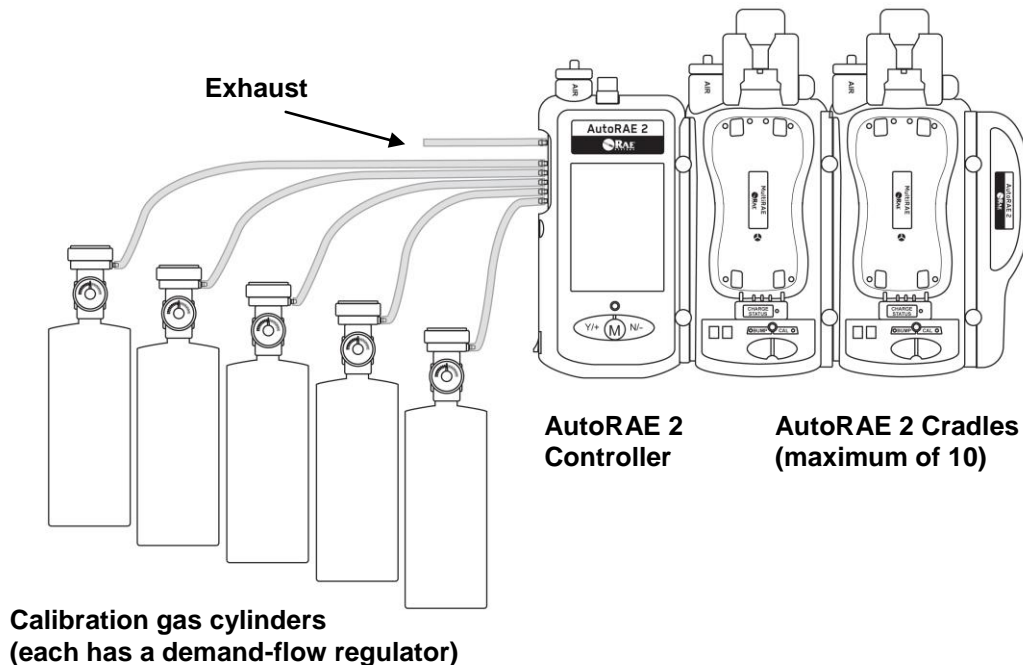

Cross-Sensitivities Determine The Order In Which Sensors Should Be Calibrated

Gases used for calibration should be configured and connected to inlet 1, inlet 2, inlet 3, etc., in the order in which the sensors should be calibrated. This applies to both a standalone cradle and controller-based systems. Refer to page 20 for more details. Information on the order of calibration is available in RAE Systems Technical Note TN-114.

AutoRAE 2 User's Guide

20.3. Placing Monitors In Cradles

When you are ready to perform bump tests or calibration tests, place monitors in the cradles, following the instructions shown on page 22.

20.4. Performing A Bump Test

The AutoRAE 2 Controller lets you perform bump tests on individual instruments or all instruments that are cradled. A bump test can be initiated by pressing a Bump button on the Cradle or selecting a Bump Test via the AutoRAE 2 Controller menus.

Press [Y/+], which selects “Function”:

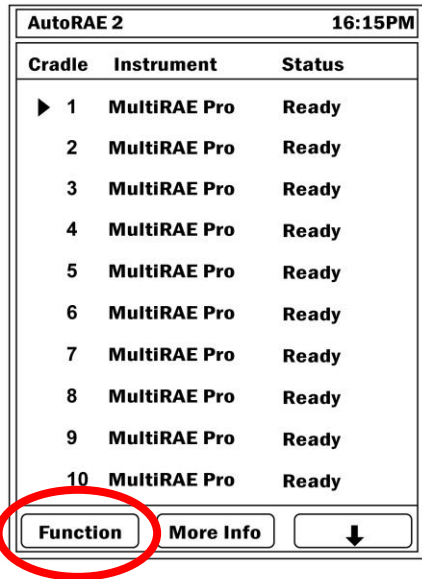

A menu is shown, with “Bump Test” at the top of the list, already selected (the triangle to the right of the name indicates the selection):

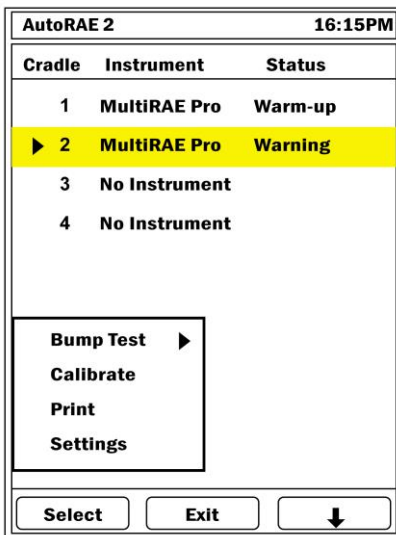

When you press [Y/+] to click “Select,” this screen appears:

AutoRAE 2 User's Guide

AutoRAE 2		16:15PM	
Cradle	Instrument	Status	
1	MultiRAE Pro	Warm-up	
▶ 2	MultiRAE P	Bump All	<input type="checkbox"/>
3	MultiRAE P	1 MultiRAE Pro	<input type="checkbox"/>
4	MultiRAE P	2 MultiRAE Pro	<input type="checkbox"/>
5	MultiRAE P	3 MultiRAE Pro	<input type="checkbox"/>
6	MultiRAE P	4 MultiRAE Pro	<input type="checkbox"/>
		5 MultiRAE Pro	<input type="checkbox"/>
		6 MultiRAE Pro	<input type="checkbox"/>
		7 MultiRAE Pro	<input type="checkbox"/>
		8 MultiRAE Pro	<input type="checkbox"/>
		9 MultiRAE Pro	<input type="checkbox"/>
		10 No Instrument	<input type="checkbox"/>
		Exit	
Bump Test	▶		
Calibrate			
Print			
Settings			

Toggle Back ↓

Note: A grayed-out box indicates that it cannot be selected.

When you check “Bump All,” the “Bump All” checkbox and all of the other checkboxes for identified instruments are checked.

AutoRAE 2		16:15PM	
Cradle	Instrument	Status	
▶ 1	MultiRAE Pro	Ready	
2	MultiRAE P	Bump All	<input checked="" type="checkbox"/>
3	MultiRAE P	1 MultiRAE Pro	<input checked="" type="checkbox"/>
4	MultiRAE P	2 MultiRAE Pro	<input checked="" type="checkbox"/>
5	MultiRAE P	3 MultiRAE Pro	<input checked="" type="checkbox"/>
6	MultiRAE P	4 MultiRAE Pro	<input checked="" type="checkbox"/>
		5 MultiRAE Pro	<input checked="" type="checkbox"/>
		6 MultiRAE Pro	<input checked="" type="checkbox"/>
		7 MultiRAE Pro	<input checked="" type="checkbox"/>
		8 MultiRAE Pro	<input checked="" type="checkbox"/>
		9 MultiRAE Pro	<input checked="" type="checkbox"/>
		10 No Instrument	<input type="checkbox"/>
		Exit	
Bump Test	▶		
Calibrate			
Print			
Settings			

Toggle Done ↓

AutoRAE 2 User's Guide

You can also select individual instruments for bump testing.

- Press [N/-] to scroll down the list.
- Press [Y/+] to toggle the selection between checked and unchecked.
- After you have made your selection(s), press [MODE] to start the bump test..

AutoRAE 2		16:15PM	
Cradle	Instrument	Status	
1	MultiRAE Pro	Warm-up	
▶ 2	MultiRAE P	Bump All	<input type="checkbox"/>
3	MultiRAE P	1 MultiRAE Pro	<input checked="" type="checkbox"/>
4	MultiRAE P	2 MultiRAE Pro	<input type="checkbox"/>
5	MultiRAE P	3 MultiRAE Pro	<input type="checkbox"/>
6	MultiRAE P	4 MultiRAE Pro	<input checked="" type="checkbox"/>
		5 MultiRAE Pro	<input type="checkbox"/>
		6 MultiRAE Pro	<input type="checkbox"/>
		7 MultiRAE Pro	<input checked="" type="checkbox"/>
		8 MultiRAE Pro	<input checked="" type="checkbox"/>
		9 MultiRAE Pro	<input checked="" type="checkbox"/>
		10 No Instrument	<input type="checkbox"/>
		Exit	
Bump Test	▶		
Calibrate			
Print			
Settings			

Toggle Done ↓

Press [N/-] to select “Exit,” and then press [Y/+] to exit.

A screen shows the instruments to be bump tested and begins a countdown. All bump tests are then performed automatically.

Bump Test Report		
Cradle	Instrument	Bump
1	MultiRAE Pro	✓
2	MultiRAE Pro	✓
3	MultiRAE Pro	✓
4	No Instrument	
5	MultiRAE Pro	✓
6	MultiRAE Pro	✓
7	MultiRAE Pro	✓
8	MultiRAE Pro	✓
9	MultiRAE Pro	✓
10	MultiRAE Pro	✓

Bump Test will start automatically in:

15 Sec

Start Quit

AutoRAE 2 User's Guide

If there is a mismatch between sensors and calibration gas settings, then this message is shown. The bump test countdown still proceeds. The sensors that do match the calibration gas settings will be bump tested.

WARNING!

Some sensors will not be bump tested or calibrated because of mismatched calibration gas settings on the instrument and AutoRAE 2.

Bump Test will start automatically in:

15 Sec

StartQuit

PERFORMING BUMP TEST

Warming up sensors.

Please Wait

Abort

PERFORMING BUMP TEST

Testing:

- Sensors
- Visual Alarms (LED Lights)
- Audible Alarm (Buzzer)

Please Wait

Abort

20.4.1. Interrupting A Bump Test

Pressing the Abort button during a bump test suspends the test, and this message appears on the AutoRAE 2 Controller's display:

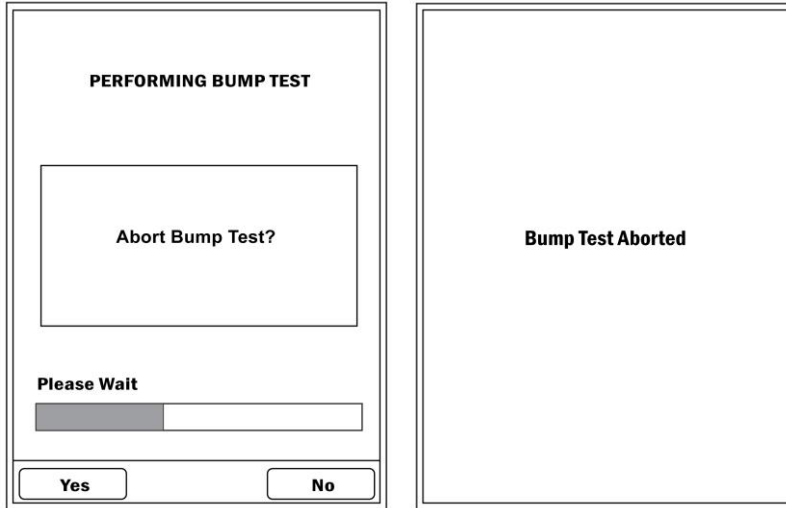

Removing an instrument from the cradle during a bump test interrupts it and results in the following message:

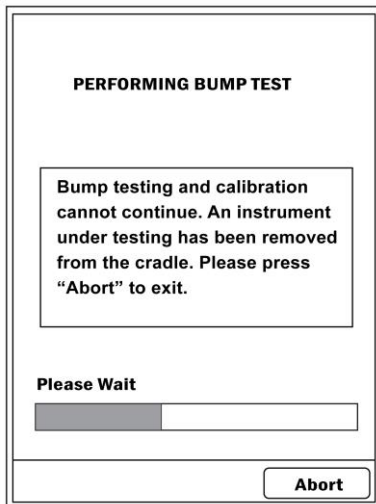

Press [N/-] to abort the bump test.

AutoRAE 2 User's Guide

When all bump tests are complete, the display shows results:

Bump Test Results		
Cradle	Instrument	Result
▶ 1	MultiRAE Pro	Pass
2	MultiRAE Pro	Pass
3	MultiRAE Pro	Pass
4	MultiRAE Pro	Pass
5	MultiRAE Pro	Pass
6	MultiRAE Pro	Pass
7	MultiRAE Pro	Pass
8	MultiRAE Pro	Pass
9	MultiRAE Pro	Pass
10	MultiRAE Pro	Pass

Reports
Exit
↓

This chart shows what the results mean:

Result	Description
Pass	All sensors passed successfully
Pass ?	All sensors that were tested passed successfully, but some sensors were not tested.
Fail	The instrument failed one or more tests
N/A	The instrument was not tested

Select a menu item, and then follow through its screens. Navigation markers are located along the bottom of each screen.

Available Information	
Instrument Details	
Bump Test Report	
Calibration Report	

Select
Exit
↓

Bump Test Report	
Monitor:	MultiRAE Pro
Cradle Number:	1
Bump Test Result:	Pass
Span 2 Calibration:	N/A
Test Performed:	8/25/2012 17:44:00



Back
→

AutoRAE 2 User's Guide

Bump Test Report

Detailed Test Results:

Monitor: MultiRAE Pro
 Cradle Number: 1
 Audible Alarm (Buzzer): Pass
 Visual Alarms (LED Lights): Pass

Sensors Installed	Status	Test Result
H2S (ppm)	Enabled	Pass
LEL (%LEL)	Enabled	Pass
Oxy (%)	Enabled	Pass
VOC (ppm)	Enabled	Pass
CO (ppm)	Disabled	N/A

● ○ ● ● ● ● ● ●

Back ➔

Bump Test Report

Sensor Information:

Monitor: MultiRAE Pro
 Cradle Number: 1

Sensors Installed	Serial Number
H2S (ppm)	32021364M5
LEL (%LEL)	03115196N3
Oxy (%)	03420044MC
VOC (ppm)	03A4*****
CO (ppm)	03060000MC

● ● ● ○ ● ● ● ●

Back ➔

Bump Test Report

Sensor Information:

Monitor: MultiRAE Pro
 Cradle Number: 1

Alarm Settings	Low	High
H2S (ppm)	10.0	10.0
LEL (%LEL)	10	50
Oxy (%)	19.5	23.5
VOC (ppm)	50.0	100.0
CO (ppm)	35	200

● ● ● ● ○ ● ● ●

Back ➔

Bump Test Report

Sensor Information:

Monitor: MultiRAE Pro
 Cradle Number: 1

Alarm Settings	STEL	TWA
H2S (ppm)	N/A	N/A
LEL (%LEL)	10	50
Oxy (%)	N/A	
VOC (ppm)	50.0	100.0
CO (ppm)	35	200

● ● ● ● ● ○ ● ●

Back ➔

Bump Test Report

Next Bump Test Due:

Monitor: MultiRAE Pro
 Cradle Number: 1

Sensor	On	In
H2S (ppm)	MM/DD/YYYY	XX Days
LEL (%LEL)	MM/DD/YYYY	XX Days
Oxy (%)	MM/DD/YYYY	XX Days
VOC (ppm)	MM/DD/YYYY	XX Days
CO (ppm)	MM/DD/YYYY	XX Days

● ● ● ● ● ○ ● ●

Back ➔

Bump Test Report

Monitor: MultiRAE Pro
 Model: PGM-6248
 Firmware: V1.03
 Serial Number: OXXXXOXXXXXX

Tested On Cradle: 1
 Cradle Type: MultiRAE Pumped
 Cradle Model: DSK-6001
 Firmware: V1.02
 Serial Number: OXXOXXXXXXXXXX

● ● ● ● ● ● ○ ●

Back ➔

AutoRAE 2 User's Guide

20.5. Performing Calibration

The AutoRAE 2 Controller lets you perform calibration on individual instruments or all instruments that are cradled. A calibration can be initiated by pressing a Cal button on the Cradle or selecting a Calibration via the AutoRAE 2 Controller menus.

Press [Y/+], which selects “Function”:

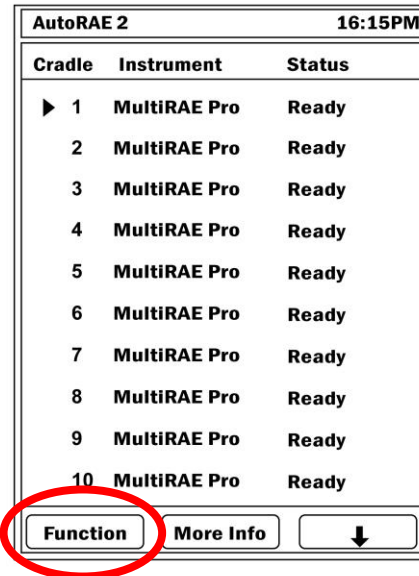

A menu is shown, with “Bump Test” at the top of the list, already selected (the triangle to the right of the name indicates the selection).

Press [N/-] until “Calibrate” is highlighted.

When you press [Y/+] to click “Select,” this screen appears:

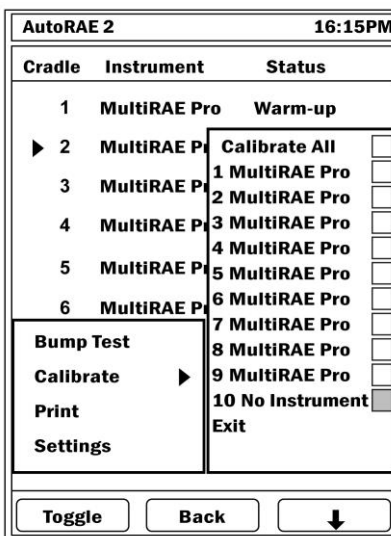

Note: A grayed-out box indicates that it cannot be selected.

AutoRAE 2 User's Guide

You can select "Calibrate All" or individual instruments.

To select "Calibrate All," press [Y/+] to check the "Calibrate All" box.

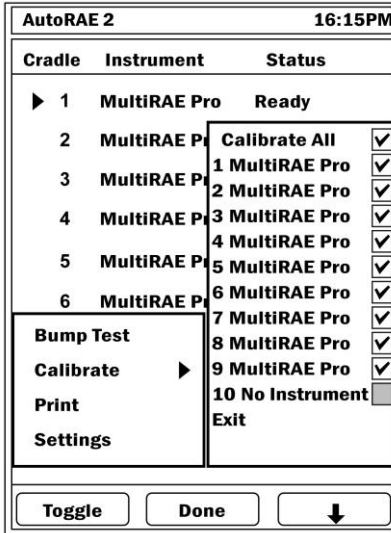

You can also select individual instruments for calibration.

- Press [N/-] to scroll down the list.
- Press [Y/+] to toggle the selection between checked and unchecked.
- After you make your selection(s), press [MODE] to select "Done" and start the calibration.

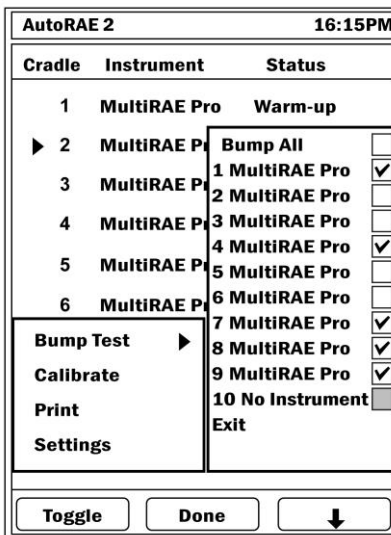

Press [N/-] to select "Exit", and then press [Y/+] to exit.

AutoRAE 2 User's Guide

A screen shows the instruments to be calibrated and begins a countdown. All calibrations are then performed automatically.

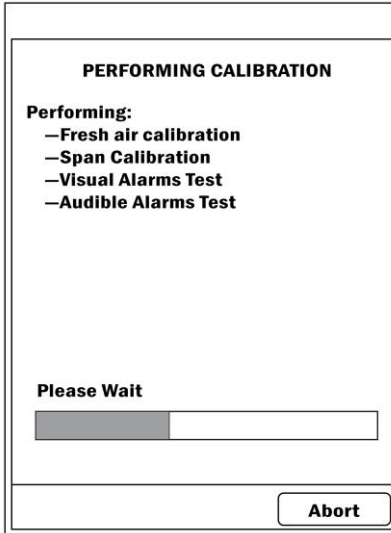

20.5.1. Interrupting A Calibration

Releasing an instrument from an AutoRAE 2 Cradle or otherwise interrupting a calibration suspends the test, and this message appears on the AutoRAE 2 Controller's display:

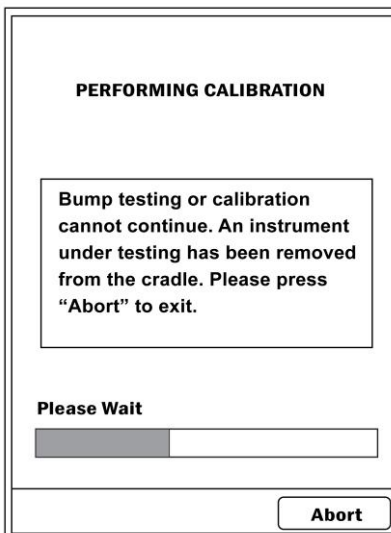

AutoRAE 2 User's Guide

If you remove the instrument, calibration cannot resume. You must abort the calibration and restart it. Press [N/-] to abort the calibration. This screen is displayed.

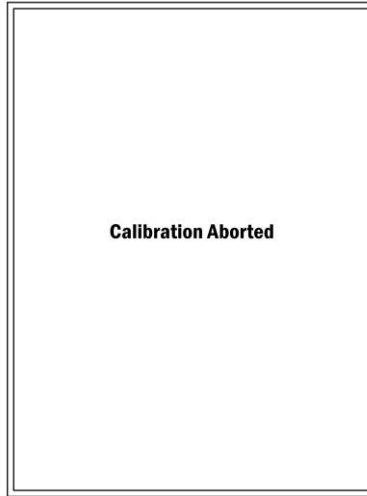

After calibration is complete, the AutoRAE 2 controller shows status:

Calibration Results		
Cradle	Instrument	Result
▶ 1	MultiRAE Pro	Pass
2	MultiRAE Pro	Pass
3	MultiRAE Pro	Pass
4	MultiRAE Pro	Pass
5	MultiRAE Pro	Pass
6	MultiRAE Pro	Pass
7	MultiRAE Pro	Pass
8	MultiRAE Pro	Pass
9	MultiRAE Pro	Pass
10	MultiRAE Pro	Pass

Reports Exit ↓

AutoRAE 2 User's Guide

When an instrument fails calibration, the word “Fail” is in the instrument’s row, and the row is highlighted in red. You can get a report for it and the other instruments in the system’s cradles by pressing [Y/+] (“Report”).

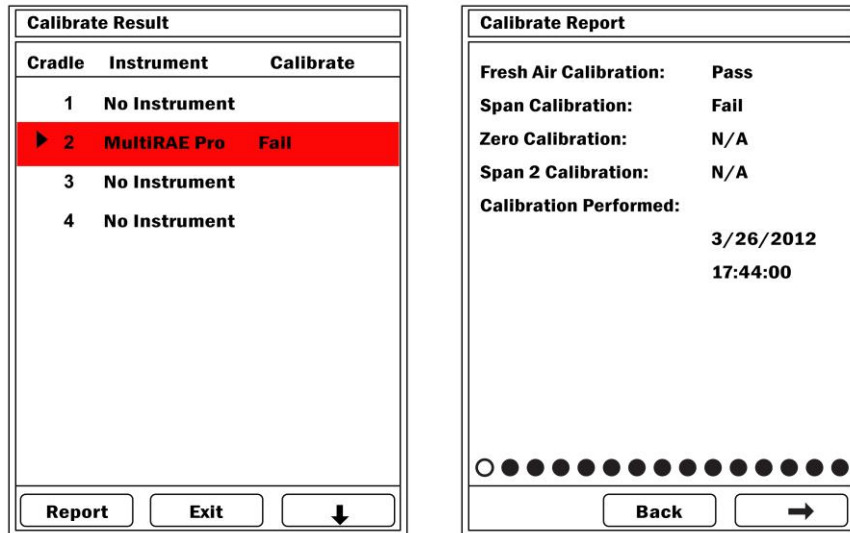

If an instrument does not pass calibration, check the sensor’s age, and consult the instrument’s User’s Guide.

20.6. Direct Bump Testing And Calibrating Via The Cradles’ Buttons

When multiple AutoRAE 2 Cradles are connected to a Controller, they can still be used individually to perform a bump test or calibration.

1. Place one or more instruments in the Cradles.
2. Press either Bump or Cal.

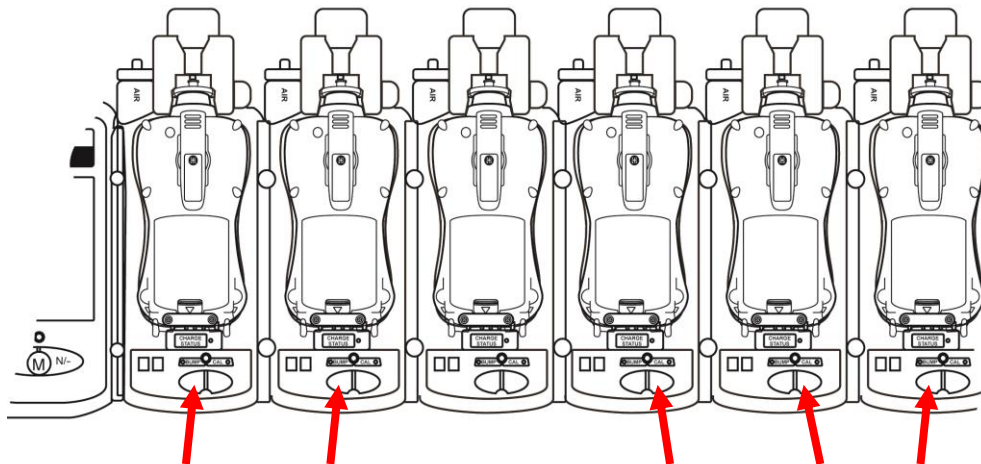

AutoRAE 2 User's Guide

You have five seconds to change your choice. After that, a screen with a list of the selected instruments and your choices of Bump or Cal. are shown. If no instrument is in one of the cradles, or if you did not choose either option, then there is no selection indicated.

Bump Test / Calibration Request			
Cradle	Instrument	Bump	Cal.
1	MultiRAE Pro	✓	
2	MultiRAE Pro	✓	
3	MultiRAE Pro	✓	
4	No Instrument		
5	MultiRAE Pro	✓	
6	MultiRAE Pro	✓	
7	MultiRAE Pro		✓
8	MultiRAE Pro		✓
9	MultiRAE Pro		✓
10	MultiRAE Pro		✓

Bump / Cal. will start automatically in:

15 Sec

Start Quit

You can start the bump tests and calibrations immediately by pressing [Y/+]. Otherwise, a countdown begins. When it reaches zero, the bump and calibrations are initiated. You can quit during this time (press [N/-]).

The instruments will undergo a bump test or calibration using parameters stored in the attached AutoRAE 2 Controller. (A stand-alone AutoRAE 2 Cradle uses the configuration stored in its internal configuration.)

AutoRAE 2 User's Guide

20.7. Configuration Settings

In addition to showing status of the most recent bump and calibration testing, the main screen provides access to check settings and change the password. At the main screen, press [Y/+], which selects “Function”:

AutoRAE 2		16:15PM
Cradle	Instrument	Status
▶ 1	MultiRAE Pro	Ready
2	MultiRAE Pro	Ready
3	MultiRAE Pro	Ready
4	MultiRAE Pro	Ready
5	MultiRAE Pro	Ready
6	MultiRAE Pro	Ready
7	MultiRAE Pro	Ready
8	MultiRAE Pro	Ready
9	MultiRAE Pro	Ready
10	MultiRAE Pro	Ready

Function More Info ↓

AutoRAE 2 User's Guide

20.8. Settings

At the main screen, press [Y/+], which selects “Function”:

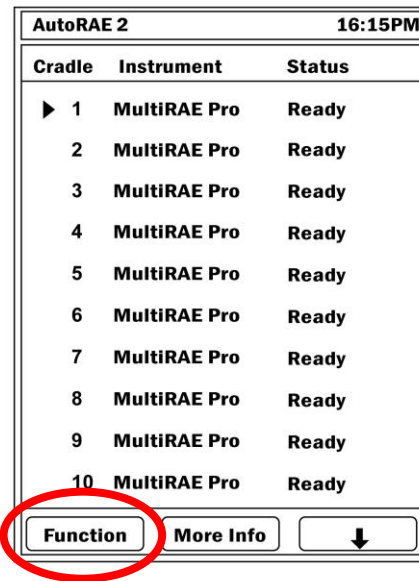

A menu is shown. Press [N/-] until “Settings” is selected (the triangle to the right of the name indicates the selection):

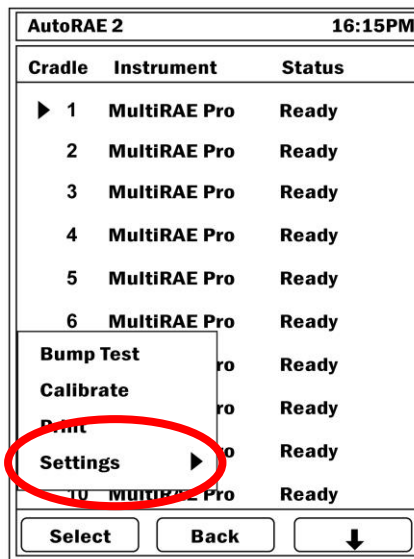

Click [Y/+] to enter Settings.

AutoRAE 2 User's Guide

A password screen is shown. You must input a password for Advanced access. (A Basic access level is reached with an incorrect password.)

The default value is “0000” (four zeroes).

- Press [Y/+] to increase a value (0 through 9).
- Press [N/-] to advance to the next digit.
- Press [MODE] after you have entered the password.

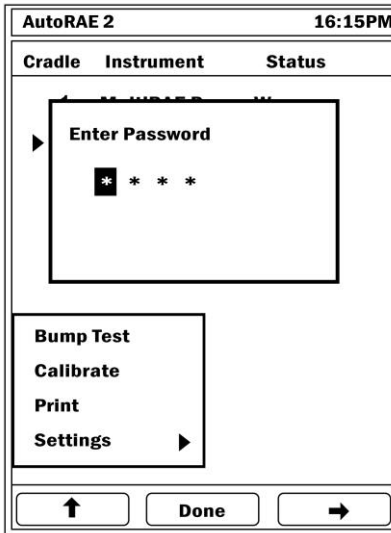

If you enter an incorrect password, this screen appears:

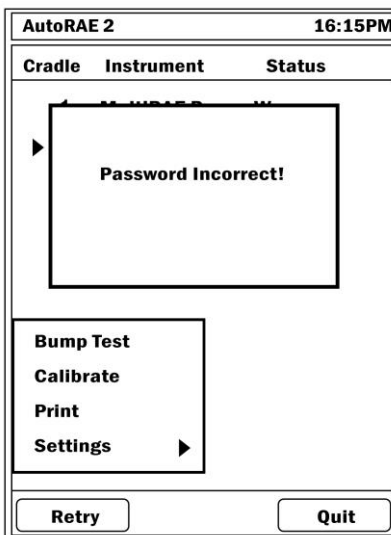

If you have entered the correct password, you see the “Gas Settings” screen.

AutoRAE 2 User's Guide

If you have entered an incorrect password again, then you access the Basic settings, which provides read-only information about the gases configured for each gas inlet:

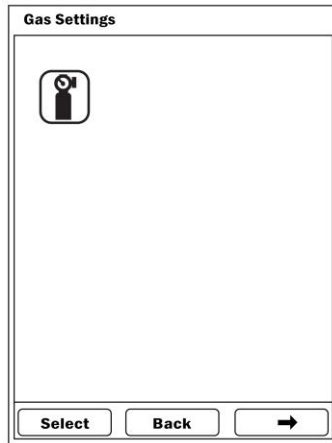

To navigate between the settings types in Advanced mode, press [N/-].
To select, press [Y/+].

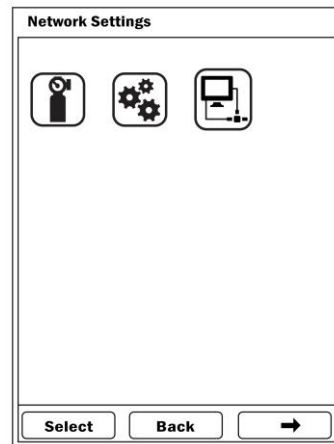
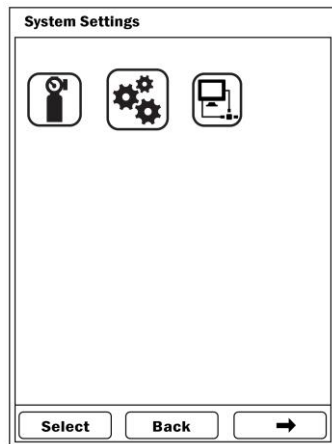
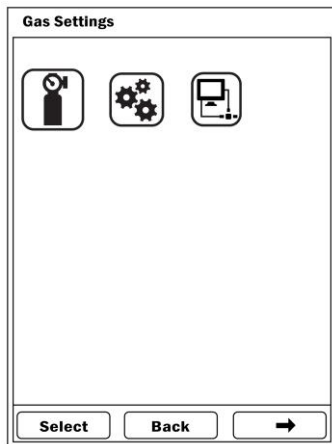

AutoRAE 2 User's Guide

20.8.1. Gas Settings

Gas Settings consists of read-only screens that show the gas configuration for each of the five gas inlets.



To advance through the settings, press [N/-]. The current screen is highlighted by the empty circle in the series of circles representing the five inlets.

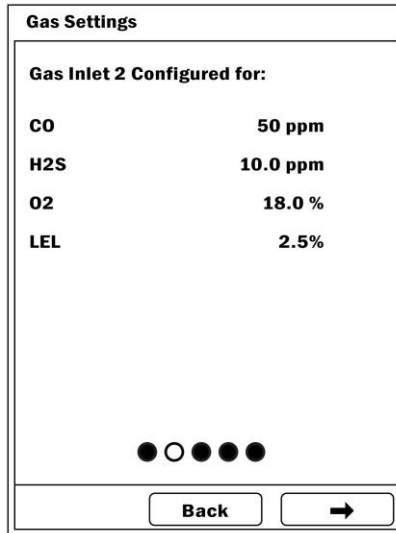
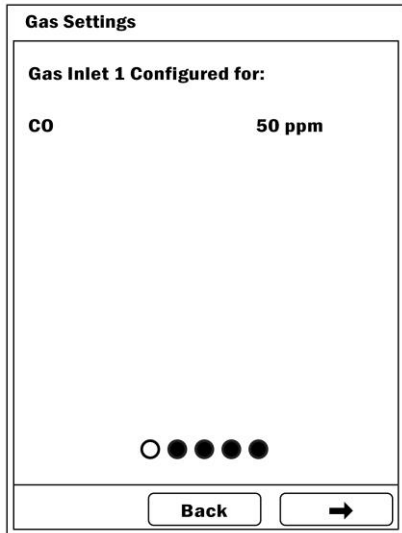

To exit from Gas Settings and return to the Settings screen, press [MODE].

AutoRAE 2 User's Guide

20.8.2. System Settings

In Advanced Mode, you are allowed to make changes to the system's settings.



System Settings (Advanced mode only) allow you to access the following:

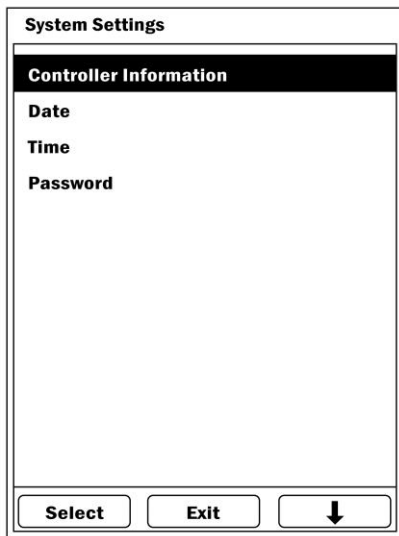

Controller Information

This is read-only information about the AutoRAE 2 Controller:

- Model
- Serial Number
- Firmware
- Built

Date

You can set the date according to the format set in ProRAE Studio II.

Press [Y/+] to advance through numbers 0 through 9.

Press [N/-] to advance to the next digit.

Press [MODE] to save the new date.

Note: If you have already set the date by using ProRAE Studio II, you do not need to set the date again. This screen is useful for checking that your date stamps are correctly set.

AutoRAE 2 User's Guide

Time

You can set the time according to the format set in ProRAE Studio II. Press [Y/+] to advance through numbers 0 through 9.

Press [N/-] to advance to the next digit.

Press [MODE] to save the new time.

Note: If you have already set the time by using ProRAE Studio II, you do not need to set the time again. This screen is useful for checking that your time stamps are correctly set.

Password

You can change the password at this screen, which shows:

- Current Password
- New Password

- Press [Y/+] to advance through numbers 0 through 9.
- Press [N/-] to advance to the next digit.
- Press [MODE] to save the new password.

Action after Bump Failed

You can select the action performed by the AutoRAE 2 if a bump test fails. Your options are:

- Calibration if Bump Test Fail
- Bump Test Only

- Press [N/-] to advance to the next option.
- Press [Y/+] to select the highlighted option or press [MODE] to go back, or press [N/-] to advance to the next option.
- Press [Y/+] to save your change or [N/-] to abort.

20.8.3. Network Settings



Network Settings lets you set up communication with a PC.

- DHCP Enable/Disable
- Host IP Address
- Subnet Mask
- Default Gateway
- Port Number

AutoRAE 2 User's Guide

DHCP Enable/Disable

You can enable or disable DHCP (Dynamic Host Configuration Protocol) at this screen.

With DHCP Enable/Disable highlighted in the Network Settings menu, press [Y/+] to access the Enable and Disable options. **Note:** The currently operational option is shown at the top in a box.

- Press [N/-] to advance to the next option.
- Press [Y/+] to select the highlighted option.
- Press [MODE] to close the window and return to the main menu.

Host IP Address

This is a read-only screen that shows the Host IP Address.

With Host IP Address highlighted in the Network Settings menu, press [Y/+] to access the Host IP Address screen.

- Press [MODE] to close the window and return to the main menu.

Subnet Mask

This is a read-only screen that shows the Subnet Mask.

With Subnet Mask highlighted in the Network Settings menu, press [Y/+] to access the Subnet Mask screen.

- Press [MODE] to close the window and return to the main menu.

Default Gateway

This is a read-only screen that shows the Default Gateway.

With Default Gateway highlighted in the Network Settings menu, press [Y/+] to access the Default Gateway screen.

- Press [MODE] to close the window and return to the main menu.

Port Number

You can view and change the Port Number at this screen.

With Port Number highlighted in the Network Settings menu, press [Y/+] to access the Port Number screen. **Note:** The default value is 9800.

- Press [Y/+] to advance through numbers 0 through 9.
- Press [N/-] to advance to the next digit.
- Press [MODE] to save the new Port Number.

21. Programming An AutoRAE 2 Controller-based System on the Computer

When it comes to an AutoRAE 2 Controller-based system configuration, some parameters, such as date and time, can be configured either on the PC or directly on the Controller screen. Other parameters, such as the AutoRAE 2 system password can only be configured directly on the Controller, whereas gas configurations (gas inlet settings), can be only configured on a PC. Firmware updates for both the Controller and all the Cradles connected to it can also only be done on a PC.

To program an AutoRAE 2 Controller-based system on a PC, you need ProRAE Studio II Instrument Configuration and Data Management Software, the AutoRAE 2 Controller-based system connected to a power source, and a USB PC communications cable.

1. Connect a USB cable between a PC with ProRAE Studio II and the AutoRAE 2 Controller.
2. Turn on the AutoRAE 2 Controller (with AC adapter connected and plugged in, power switch toggled so red LED light is glowing).
3. Start ProRAE Studio II software on the PC.
4. Select “Administrator” and input the password (the default is “rae”).
5. Click “Detect the instruments automatically” (the magnifying glass icon with the letter “A” in it). After a few seconds, the AutoRAE 2 Controller is found and it is shown, along with its firmware version, serial number, COM port:
6. Click “Select.”

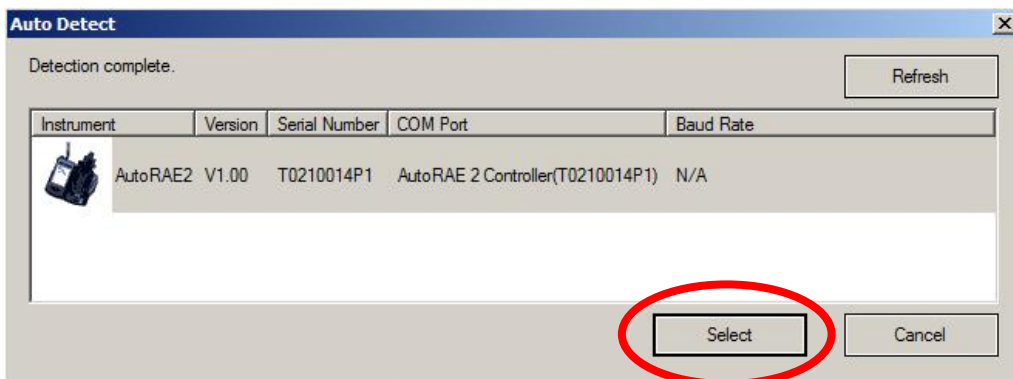

7. Click “Setup.”

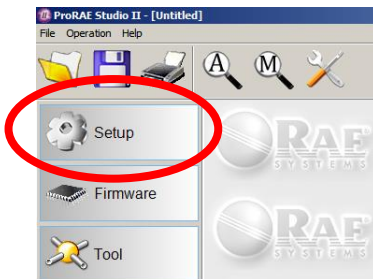

AutoRAE 2 User's Guide

ProRAE Studio II downloads the AutoRAE 2 Controller and all attached AutoRAE 2 Cradles' configuration data (a progress bar is shown during downloading).

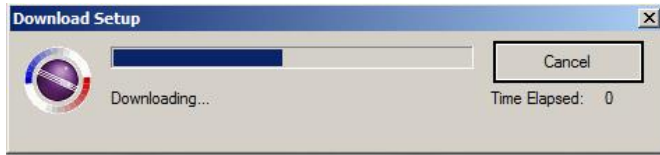

Note: The AutoRAE 2 Controller's display shows this message while it is connected and communicating with a PC running ProRAE Studio II:

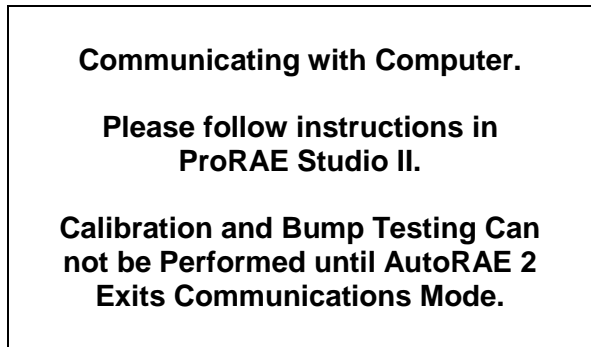

In ProRAE Studio II, the AutoRAE 2 Controller is shown, including its Serial Number, under "Online":

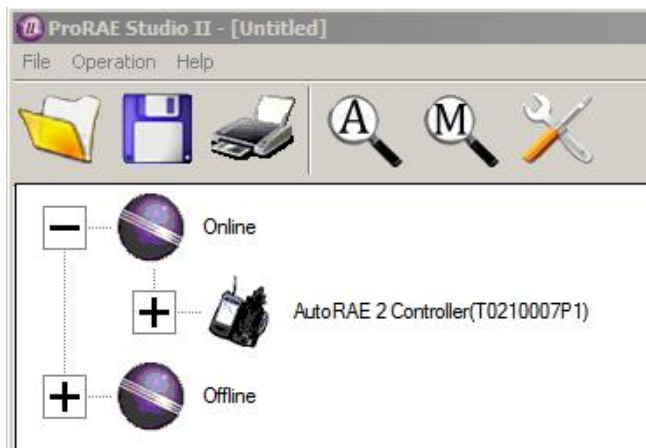

AutoRAE 2 User's Guide

You can expand the view to show AutoRAE 2 Cradles attached to the AutoRAE 2 Controller by clicking the “+” to the left of the image of the AutoRAE 2 Controller:

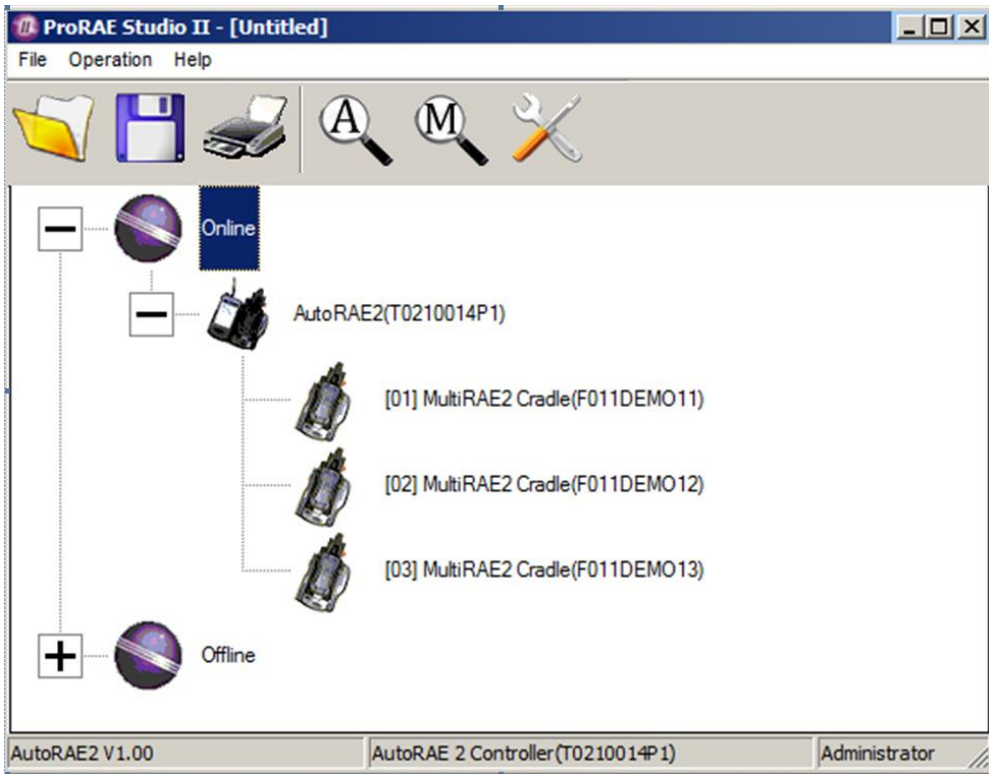

Double-click the AutoRAE 2 Controller to check its settings and to program it. The Setup/Firmware screen appears:

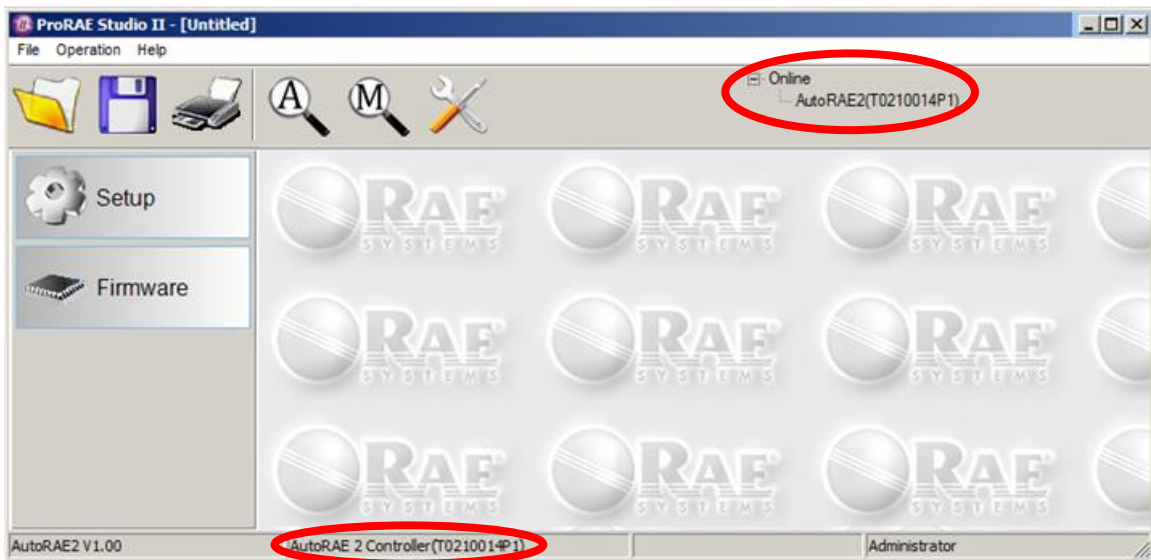

Notice that it shows the AutoRAE 2 controller is active, both in the status bar along the bottom and in the hierarchy at the top of the screen.

AutoRAE 2 User's Guide

Click “Setup” to begin programming. This setup screen is shown:

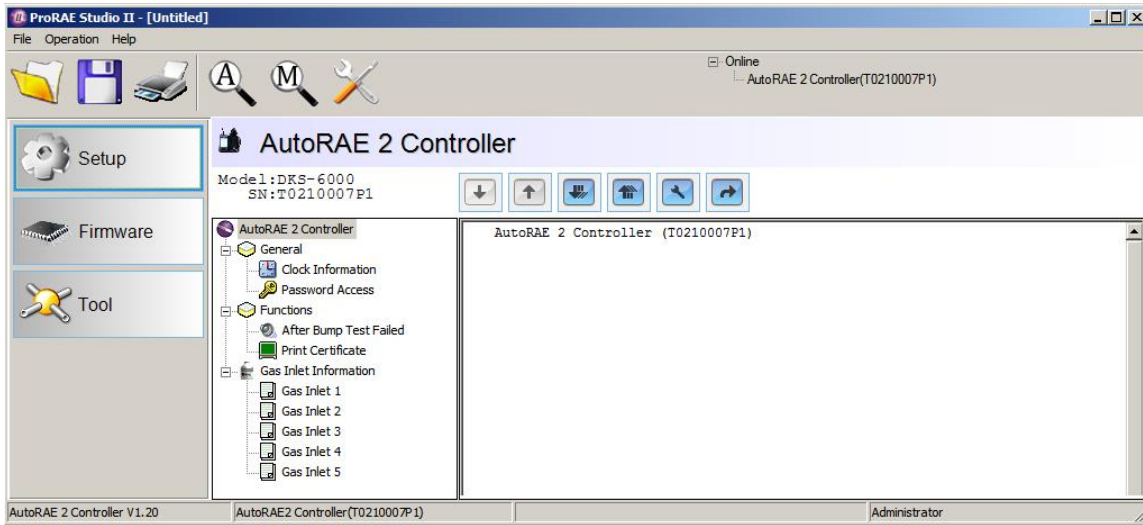

Click “Clock Information” to check or set the time:

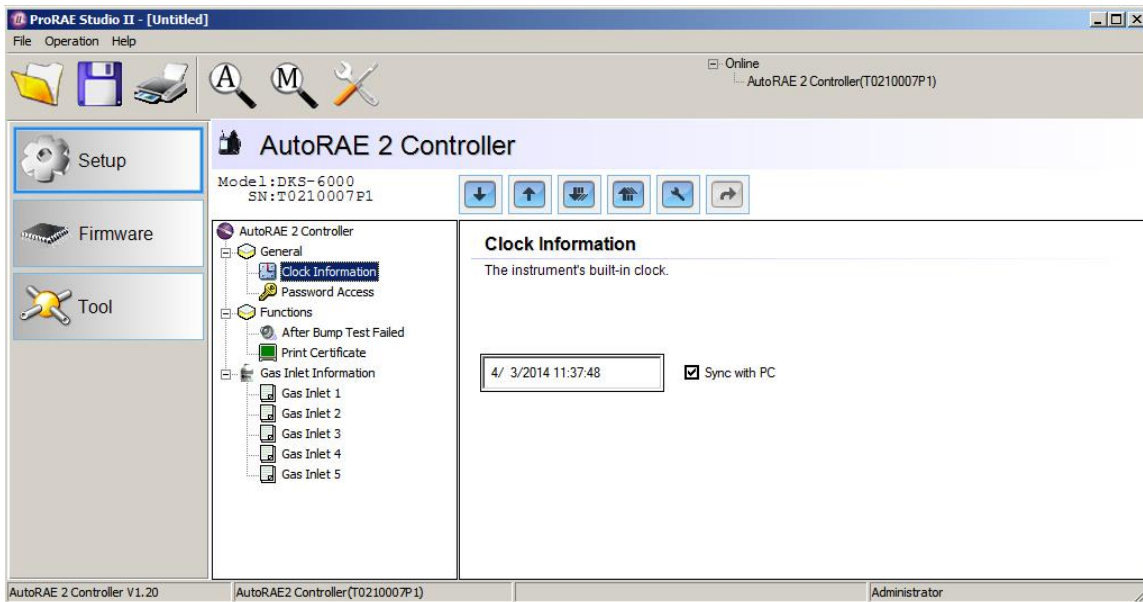

If you want to synchronize the date and time on the AutoRAE 2 Controller with the date and time on the PC, click the box labeled “Sync with PC.”

AutoRAE 2 User's Guide

Set the password for access to the AutoRAE 2.

Note: The default value is “0000.”

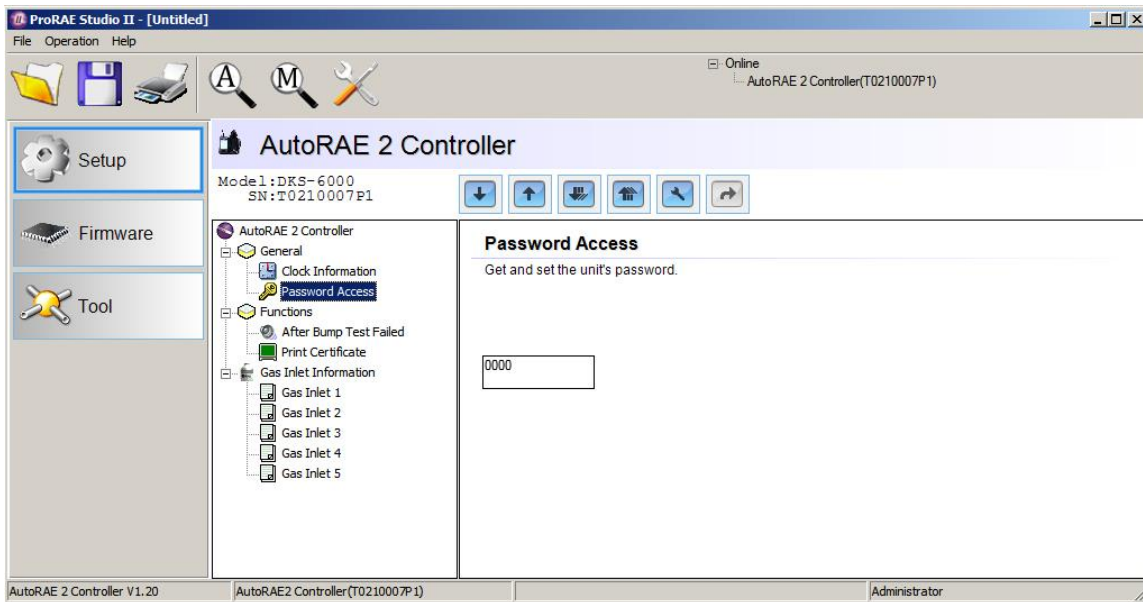

21.1. Gas Inlet Settings

“Gas Inlet Information” tells the AutoRAE 2 what kind of gas is supplied to each gas inlet. The “Gas Inlet Information” section includes configuration parameter settings for the five gas inlets on the AutoRAE 2 Controller. For each “Gas Inlet,” you can view and set the gas type, concentration, concentration unit, purge time, and soak time. You can modify these values and upload them to your AutoRAE 2 or download the values currently programmed into the AutoRAE 2 to ProRAE Studio II.

There are five gas configurations (Gas Inlet 1 through Gas Inlet 5), and each can be customized to suit the number and types of gases in each gas inlet.

Select a Gas Inlet under “Gas Inlet Information”:

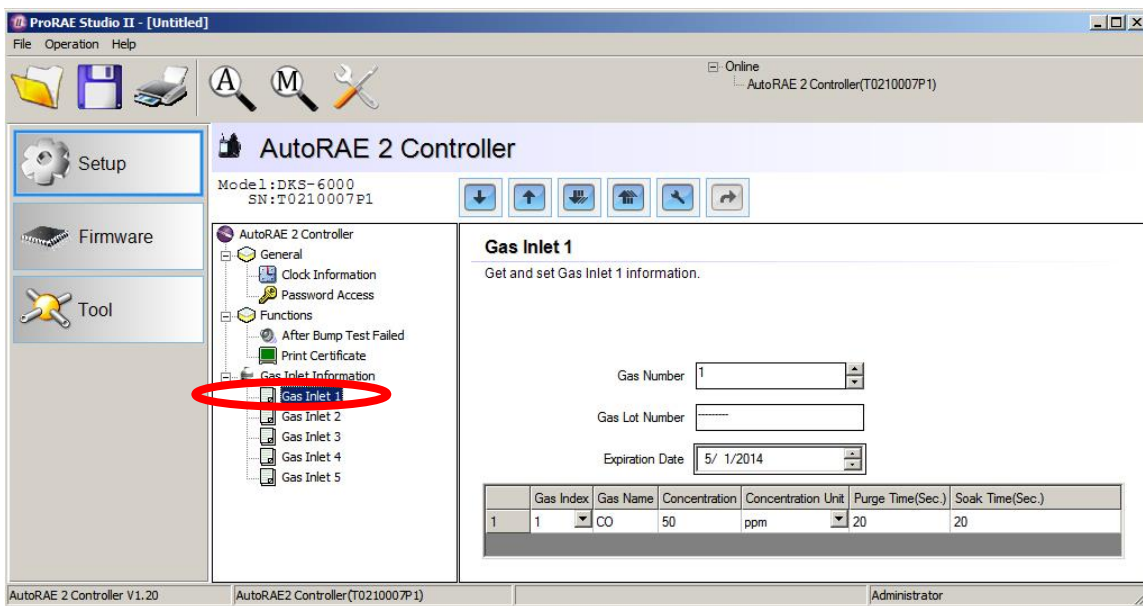

The window now shows the selected Gas Inlet (Gas Inlet 1 shown), its Gas Number (number of gases in the gas mix, if the cylinder contains more than one gas; single gas shown), Gas Lot Number, Expiration Date, and data that includes Gas Index, Gas Name, Concentration, Concentration Unit, Purge Time (Sec.), and Soak Time (Sec.).

21.2. Configuring A Gas Inlet

Each Gas Inlet section is designed so that you can define individual gases or gas combinations to match the cylinders you are planning to use with an AutoRAE 2 Controller-based system. Besides the number of gases, you can change each one's Gas Index (and Gas Name), Concentration, Concentration Unit, Purge Time, and Soak Time. In addition, you can change the Gas Lot Number and expiration date for each cylinder.

21.2.1. Gas Number

This is the number of gases (up to eight) present in a single Gas Inlet. Click the up arrow to increase the number or the down arrow to decrease the number. **Note:** The number can

AutoRAE 2 User's Guide

be zero (0). This allows you to effectively remove the corresponding inlet from calibrations and bump testing.

21.2.2. Gas Lot Number

Fill in the numbers to correspond to the lot number printed on the gas cylinder. This will be included in any test and calibration certificates generated while bump testing or calibrating instruments using this gas.

21.2.3. Expiration Date

Click on each number and use the up/down arrows to change the date numbers to correspond to the expiration printed on the gas cylinder. This will be included in any test and calibration certificates generated while bump testing or calibrating instruments using this gas.

21.2.4. Gas Index

You can use the pull-down menus to select Gas Index values corresponding to the gas of interest. Supported gases include:

1 - CO	9 - HCl	17 - CH ₃ SH
2 - H ₂ S	10 - HF	18 - CO ₂
3 - SO ₂	11 - Cl ₂	19 - Isobutylene
4 - NO	12 - ClO ₂	20 - Benzene
5 - NO ₂	13 - H ₂	21 - Propane
6 - HCN	14 - HCHO	22 - Methane
7 - NH ₃	15 - COCl ₂	23 - Nitrogen
8 - PH ₃	16 - O ₂	24 - ETO

Note: The currently selected Gas Index (and name) is highlighted. Use the scroll bar to select the desired gas.

21.2.5. Gas Name

When you change the Gas Index number, and then click elsewhere in the table, the Gas Name is updated automatically to the new gas name corresponding to the selected Gas Index.

21.2.6. Concentration [Value]

You can set the concentration by double-clicking in the respective gas concentration box and then typing in the concentration value.

AutoRAE 2 User's Guide

21.2.7. Concentration Unit

When you pull down the Concentration Unit menu, select the desired gas concentration unit (there are other types of units).

ppm
%
ppb
mg/m³
ug/m³
%LEL
%VOL
%CH₄

21.2.8. Purge Time (Sec.)

Type to set the number of seconds for the system to purge with fresh air after performing a bump test or calibration.

21.2.9. Soak Time (Sec.)

Type to set the number of seconds for the system to allow the sensor to be pre-exposed to calibration gas before bumping or calibrating.

21.3. Uploading Settings To The AutoRAE 2

When you are done setting the Gas Bottle parameters, upload them to the AutoRAE 2 by clicking on the “Upload all settings to the instrument” icon:



1. A dialog box appears:

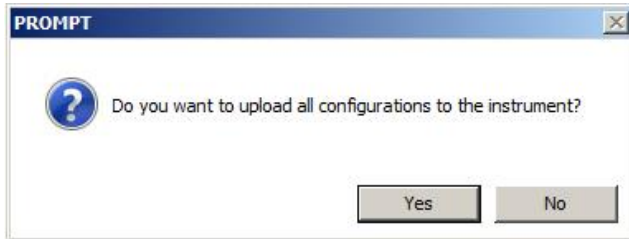

- Click “No” if you do not want to upload the configurations.
- Click “Yes” to upload the configurations.

2. During the upload process, a progress bar is shown:

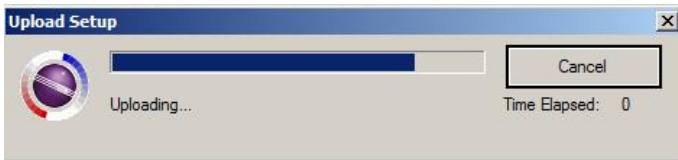

21.4. Downloading & Uploading Individual Gas Bottle Settings

If you only want to download a single set of Gas Bottle settings from the AutoRAE 2, click the name (Gas Bottle 1 through 5), and then click the “Get Current Content Settings” button:



If you want to upload a single set of Gas Bottle settings to the AutoRAE 2, click the name (Gas Bottle 1 through 5), and then click the “Set Current Content Settings” button:



21.5. Saving The Settings File

If you want to save the settings for backup or for use later, click the “Save Current Data” button and then save the file. The file has an extension of “.prs” (a ProRAE Studio II file).

21.6. Recalling Stored Settings

If you have previously stored settings in a separate file, you can call them up so that you can modify them and/or apply them to the AutoRAE 2 system. This feature is especially useful if you have multiple individual systems to which similar settings need to be populated.

1. Click the “Open A Saved File” (folder) icon.
2. Find the ProRAE Studio file you want to upload from your PC (it will have a .prs suffix).
3. Click “Open.”

Note: Opening a file overwrites any settings (modified or unmodified) already in the active ProRAE Studio II session.

You may now modify or upload these settings.

21.7. Uploading Settings To Multiple AutoRAE 2 Systems

You can apply settings to multiple AutoRAE 2 systems. Simply connect one system to the PC and upload the settings as outlined in the previous section, disconnect that system, connect another, and then upload settings.

21.8. Exiting Programming

When you are done programming and have saved the settings, do the following:

1. Exit ProRAE Studio II.
2. Press [MODE] on the AutoRAE 2 Controller to exit Communications Mode.
3. Disconnect the USB cable between the PC and the AutoRAE 2 Controller.

22. Updating Firmware On The AutoRAE 2 Controller

Updates to the AutoRAE 2 Controller's firmware may be produced, and these can be loaded into the AutoRAE 2 Controller using ProRAE Studio II software running on a PC.

1. Download firmware from the RAE Systems web site or from a CD-ROM.
2. Connect a PC running ProRAE Studio II to the AutoRAE 2 Controller via a USB cable.
3. Start ProRAE Studio II.



4. Click "Administrator."

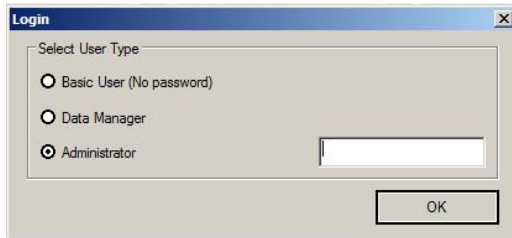

5. Enter the password (the default is "rae").



6. Click "OK."
7. Click "Detect the instruments automatically."



AutoRAE 2 User's Guide

8. Select the AutoRAE 2 Controller.

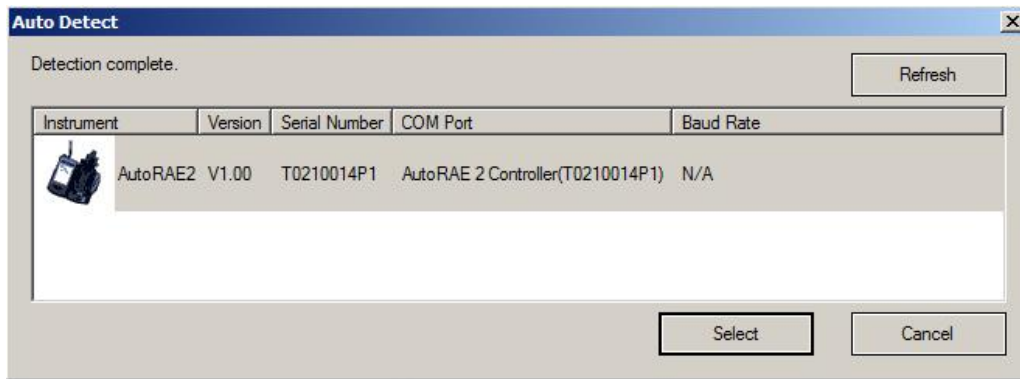

9. Click “Select.”
10. The AutoRAE 2 Controller is shown, along with its serial number. Click “Firmware.”

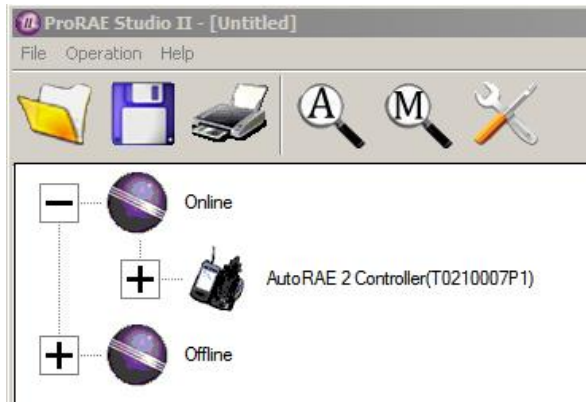

11. Double-click on the AutoRAE 2 Controller's icon, and this screen appears:



The options on the left are “Setup,” “Firmware,” and “Tool.”

AutoRAE 2 User's Guide

12. Click the “Firmware” button. Now this window appears:

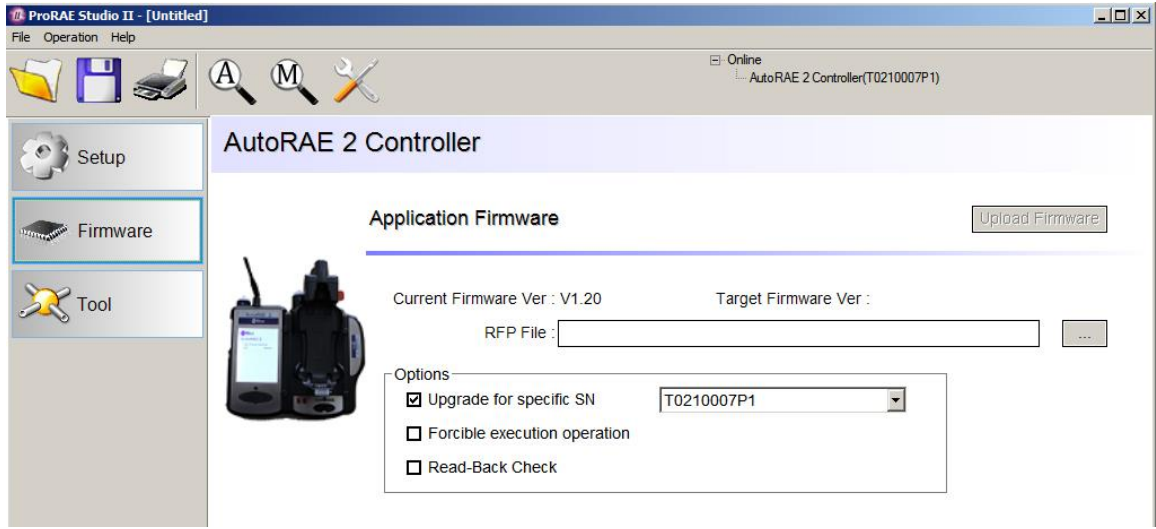

13. Where it says “RFP File:” click the button labeled “...” and locate the firmware file with the “.rfp” suffix. Then click “Upload Firmware.”
14. Click the box labeled “Upgrade for specific SN, and then pull down the menu and select the serial number that matches the one shown in the upper right side of the window.

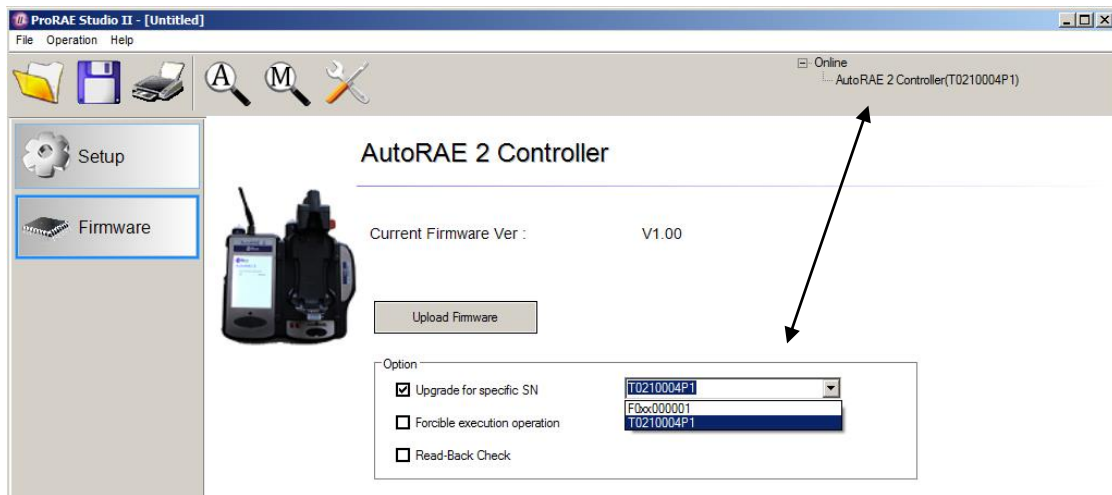

15. Click “Upload Firmware.”
16. Find and select the firmware file with a “.rfp” extension.



17. Click “Open.”

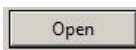

AutoRAE 2 User's Guide

18. The firmware file is uploaded to the AutoRAE 2 Controller's SD card, and the AutoRAE 2 Controller uploads the firmware to the AutoRAE 2 Controller or cradle, respectively.
19. Exit ProRAE Studio II on the PC.
20. Disconnect the USB cable.

23. Transferring AutoRAE 2 Controller Data To A Computer

Bump and calibration data is collected each time an instrument is bump tested or calibrated. The AutoRAE 2 Controller collects this data and stores it on an SD Card, providing a convenient means of storage and easy data transfer.

Follow this procedure for reading calibration and bump testing data from an AutoRAE 2 controller:

1. Connect a USB cable to the AutoRAE 2 Controller and to a PC running ProRAE Studio II software
2. Make sure the AutoRAE 2 Controller has power and is turned on.
3. Start ProRAE Studio II software on the PC.
Note: You can get reports with any level of access privileges.
4. Click “Detect the instruments automatically” (the magnifying glass icon with the letter “A” in it). After a few seconds, the AutoRAE 2 Controller is found and it is shown, along with its firmware version, serial number, COM port:
5. Click “Select.”

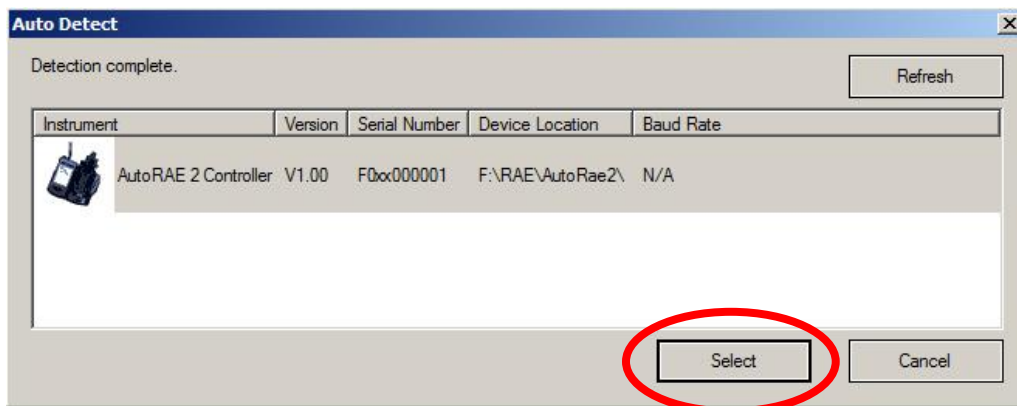

AutoRAE 2 User's Guide

6. This screen appears:

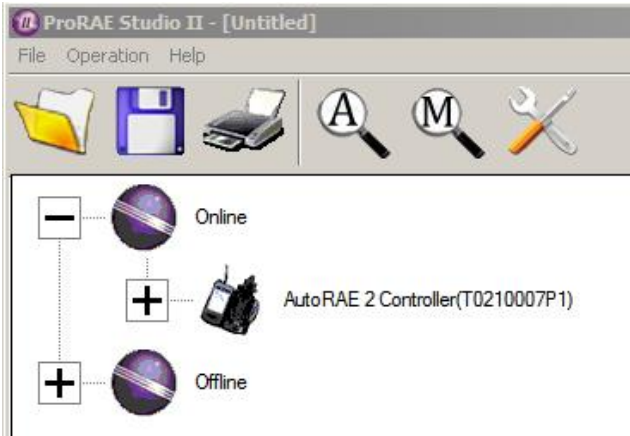

- 7. Expand either Online or Offline to view Instruments.
- 8. Click "Instruments."

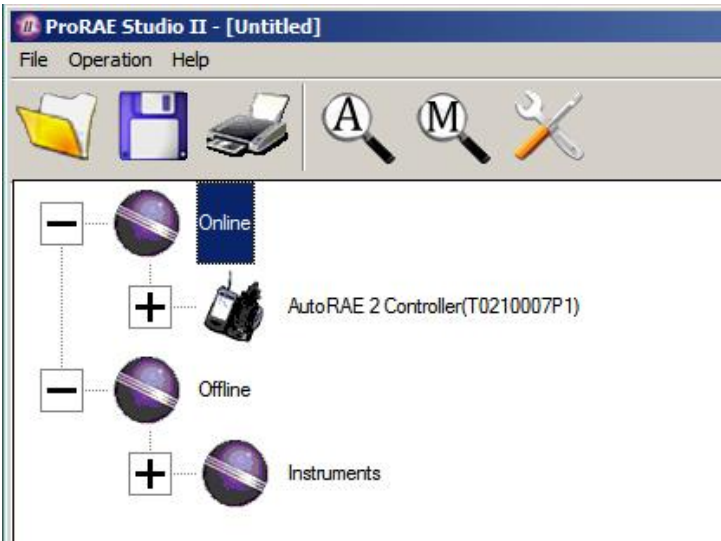

AutoRAE 2 User's Guide

Instruments that have been bump tested and calibrated on a system with this AutoRAE 2 Controller are shown:

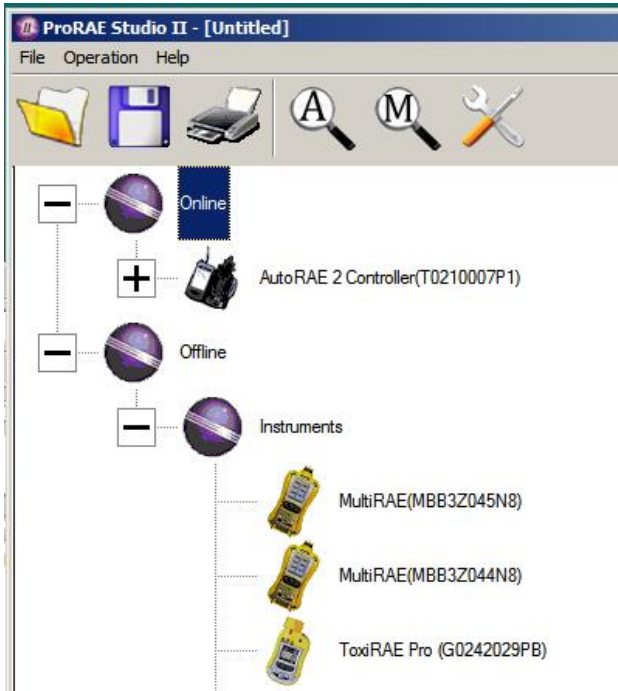

AutoRAE 2 User's Guide

9. Double-click on an instrument to view its reports:

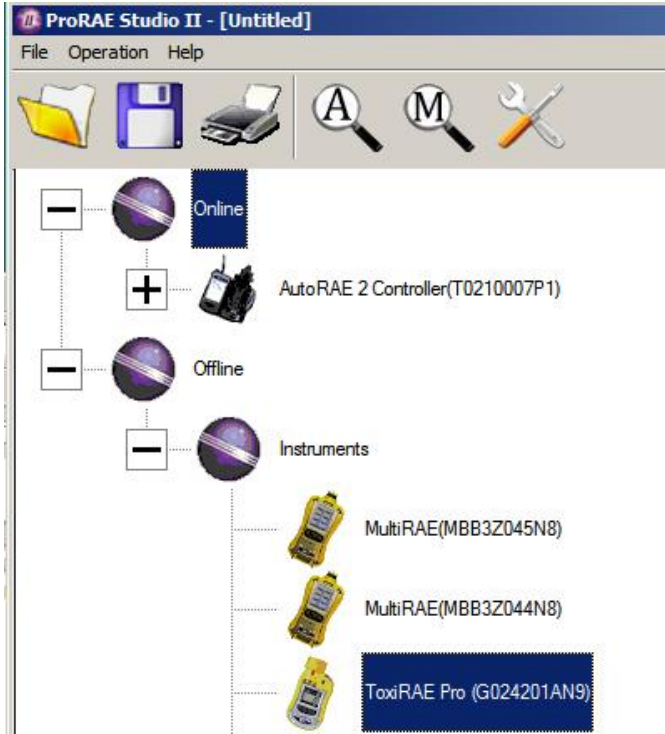

The Reports window opens for this instrument:



AutoRAE 2 User's Guide

10. Click “Reports,” and the window changes:

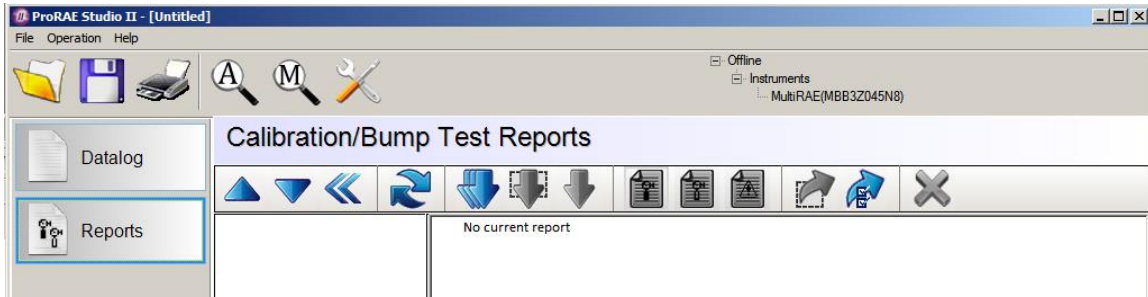

11. Click the “Download All Reports” button:



If there are no reports, an alert appears:



If there are reports, then they are downloaded and put in a list in the left column:

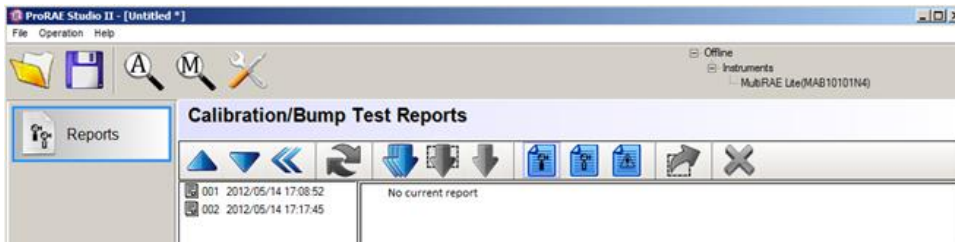

If the list is long, you can change the order so the list order is reversed (from 001, 002, 003, etc., to 003, 002, 001, etc.). Press one of these two buttons to change the sort order:



12. Select a report by clicking on the report's date and number.

Note: You can change the name of a report by double-clicking its name and then changing the name in the dialog box that pops up:





AutoRAE 2 User's Guide

13. When you are done, click “OK.”

Caution! Once you change the name of the report and click “OK,” the change cannot be undone. If you want to change the report's name back to its original, you must do it by typing in the information.

With a record set highlighted, click any of the three report types:

	Calibration report
	Bump Test report
	Policy Violation report

A typical bump or calibration report is shown in the right window:

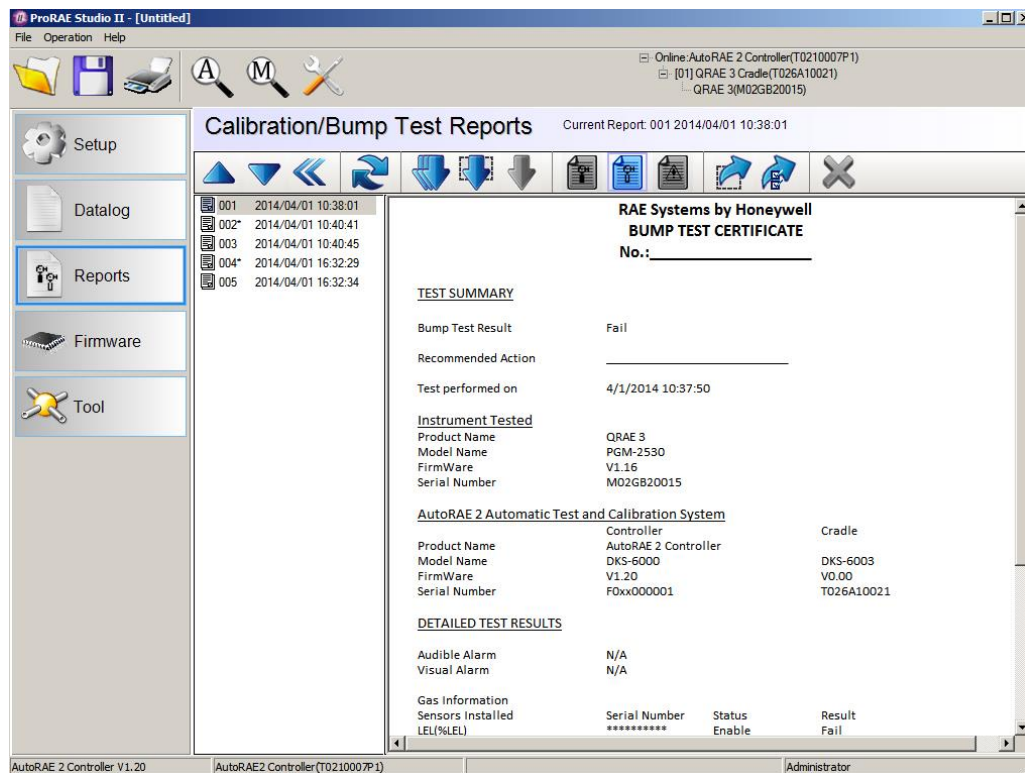

The screenshot displays the ProRAE Studio II interface. The main window shows a list of reports on the left and a detailed view of a Bump Test Certificate on the right. The certificate is titled "RAE Systems by Honeywell BUMP TEST CERTIFICATE" and includes the following information:

- TEST SUMMARY**
 - Bump Test Result: Fail
 - Recommended Action: _____
 - Test performed on: 4/1/2014 10:37:50
- Instrument Tested**
 - Product Name: QRAE 3
 - Model Name: PGM-2530
 - FirmWare: V1.16
 - Serial Number: M02GB20015
- AutoRAE 2 Automatic Test and Calibration System**
 - Product Name: Controller
 - Model Name: AutoRAE 2 Controller
 - FirmWare: DKS-6000
 - Serial Number: F0xx000001
 - Product Name: Cradle
 - Model Name: DKS-6003
 - FirmWare: V0.00
 - Serial Number: T026A10021
- DETAILED TEST RESULTS**
 - Audible Alarm: N/A
 - Visual Alarm: N/A
 - Gas Information: Serial Number Status Result
 - Sensors installed LEL(%LEL): ***** Enable Fail

23.1. Exporting Reports

The report can be exported for archiving or sending. It can be saved as a Rich Text Format (.rtf) file, making it easy to import into most word-processing programs such as Microsoft Word, or it can be saved as a text file (.txt). Click this button, locate where you want to save the file, select the type of file (RTF or TXT), rename it if you like, and then click “Save.”

AutoRAE 2 User's Guide

23.2. Saving A Configuration Upon Exit

When you close ProRAE Studio II after you have downloaded reports or made changes, you will see this prompt:

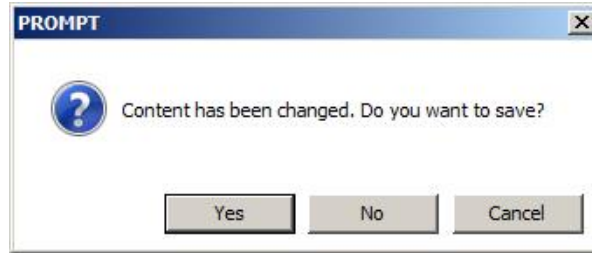

If you do not want to save changes to the configuration, click "No." If you want to save the changes, click "Yes." Select a name for the file, which will be saved as a ProRAE Studio configuration file with an extension of ".prs," and select where you would like to save it. Then click "Save."

24. Wireless Operation

The AutoRAE 2 Controller can communicate wirelessly with a PC running ProRAE Studio II, and operates in the same manner (that is, the wireless connection substitutes for a hardwired connection). This requires purchasing an optional WiFi Adapter and configuring it properly for your network. It also requires configuration of the AutoRAE II Controller.

Software and firmware requirements:

- ProRAE Studio 2 (PRS2) V1.8.1 Build 133 (or newer)
- AutoRAE2 controller firmware V1.20 (or newer)
- AutoRAE 2 Utility V1.02 Build 105 (or newer)

Note: This procedure has been tested with NetGear's WNCE2001 Universal Wi-Fi Internet Adapter (or equivalent)

24.1. Part One: Configure The AutoRAE 2 Network Interface

1. Connect an Ethernet cable between the PC and the AutoRAE 2 Controller.

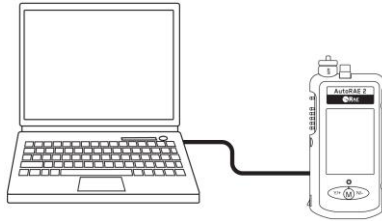

2. On the AutoRAE 2 Controller, enter Function and then Settings choose "Select."
3. When the dialog box appears, input your password. Select "Done."
4. Now choose Network Settings and "Select" again. The first option is DHCP Enable/Disable (see Figure 1).



Figure 1. AutoRAE2 Network Setting Menu.

AutoRAE 2 User's Guide

5. Enter or verify network settings. Following is an example that works with its relative PC settings throughout this procedure.
 - a. Disable DHCP.
 - b. Set the Host IP Address, which is the address of AutoRAE 2 Controller. (The following values are for reference only; use values specific to your network.)

Note: The AutoRAE 2 Controller is the host (or server) when connected to the PC via Ethernet.

Enter: 172.16.121.25

Subnet mask: 255.255.255.0

Default gateway: 172.16.121.1

Port number: (use your active port number)

6. Restart the AutoRAE 2 Controller (turn it off and on again).
7. Set the corresponding PC Ethernet port IP address, subnet mask, and default gateway manually as shown in Figure 2 for connection to AutoRAE2.

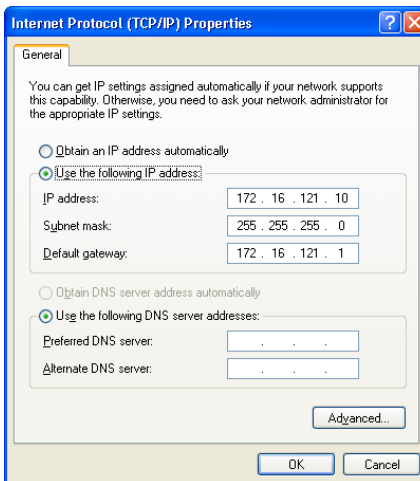

Figure 2. Manually Set PC network properties for connection to AutoRAE 2.

8. Run ProRAE Studio II. The program should be able to detect the AutoRAE 2 Controller via the Ethernet cable and communicate with the AutoRAE 2 Controller normally.

24.2. Part Two: Configure The WiFi Adapter & Test The Network

Disconnect the Ethernet cable from the PC and the AutoRAE 2 Controller. You will now use the PC's built-in Wi-Fi wireless modem and a WiFi Internet Adapter connected to AutoRAE2. Communication will be over a wireless network.

AutoRAE 2 User's Guide

1. Keep all the network settings that you provided in Part One. Disconnect and remove the Ethernet cable.
2. Connect a Wi-Fi Internet Adapter (the Netgear WNCE2001 NetGear Universal Wi-Fi Internet Adapter is recommended) to the PC's network port using the Ethernet cable shipped with the WiFi Internet Adapter. Connect power to the WiFi Internet Adapter.

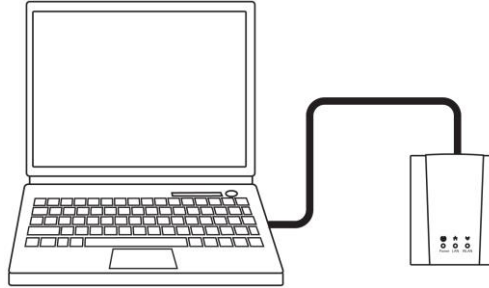

3. Open the Internet Protocol (TCP/IP) Properties of the PC network port. Set “Obtain an IP address automatically” as in Figure 3 for the WiFi Internet Adapter setup. Also make sure the “Obtain DNS server address automatically” button is selected.

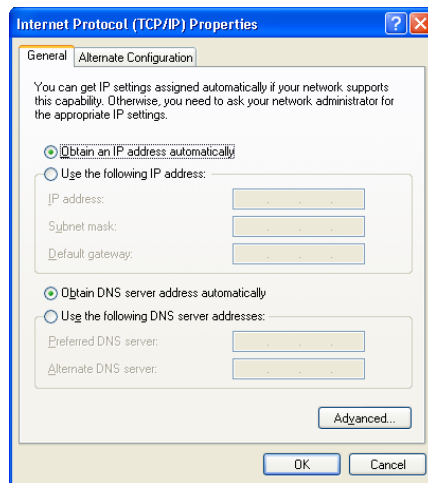

Figure 3. Set PC network properties to automatic for the WiFi Internet Adapter.

4. Make sure that the PC has no other Ethernet connection (wired or wireless), except the connection to the WiFi Internet Adapter. Open a web browser in Windows. The WiFi Internet Adapter setup menu will be shown as Figure 4 to Figure 6. Note: You must select a region. Then click the “Continue” button.
5. Following the process shown in Figure 4 to Figure 6, select a wireless network, enter the password for the wireless network, and confirm settings/connection.

AutoRAE 2 User's Guide



Figure 4. Select a wireless network. (This example shows all available wireless networks within range. Your choices will be different.)

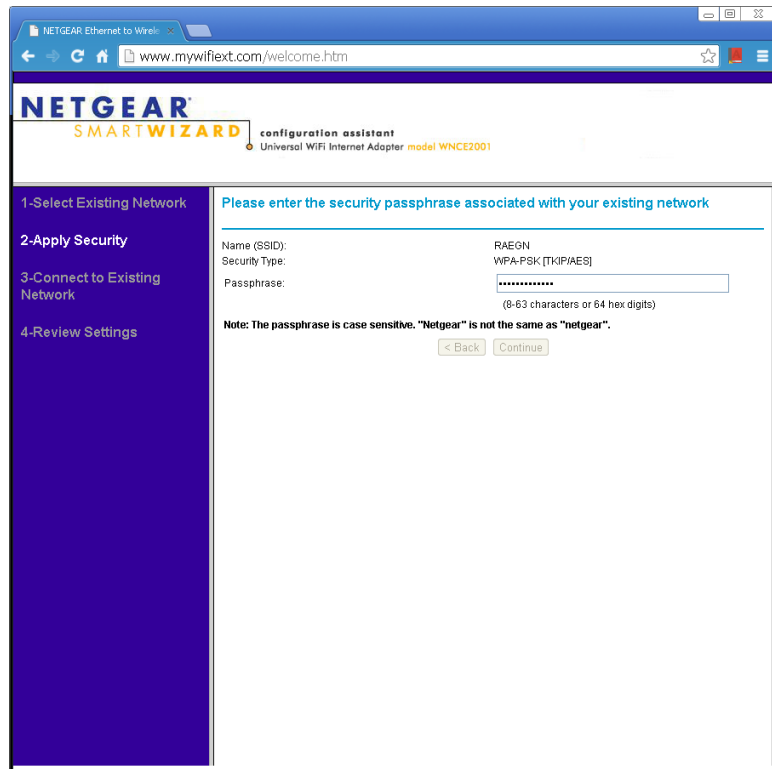

Figure 5. Enter a password to access the selected wireless network.

AutoRAE 2 User's Guide

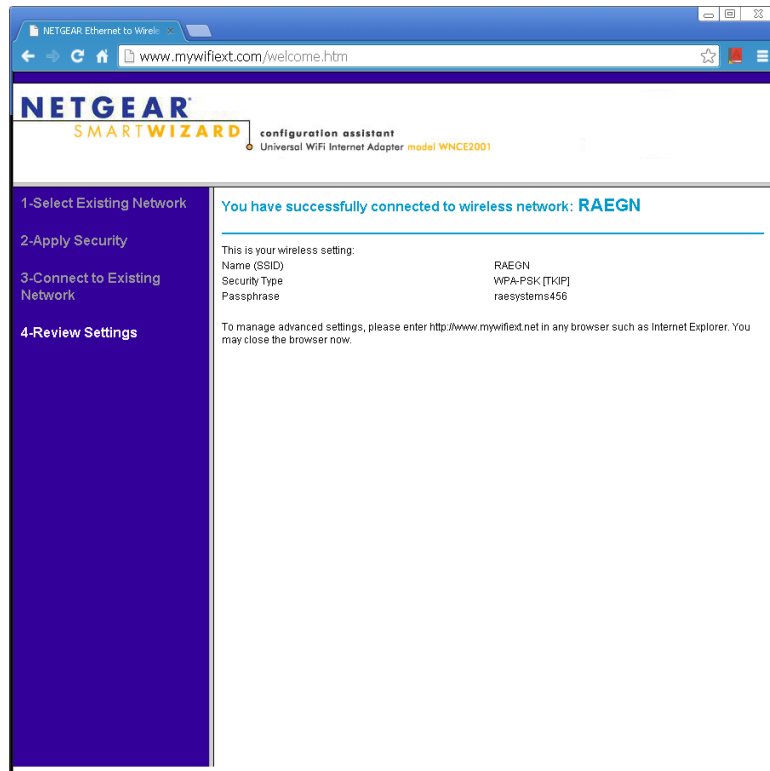
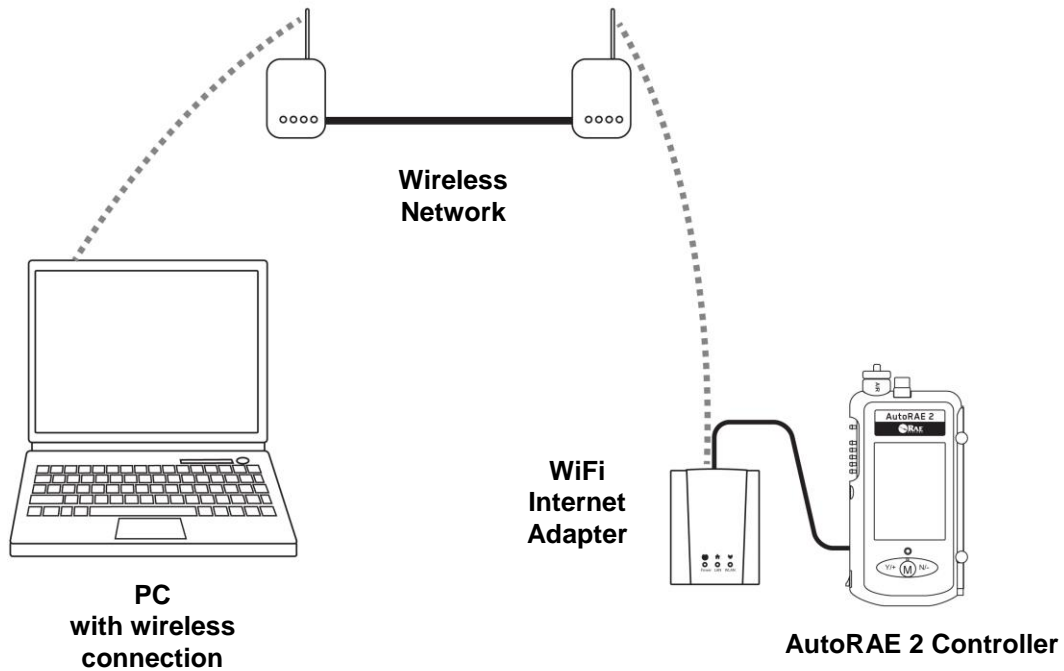

Figure 6. Confirm that the WiFi Internet adapter successfully connected to the selected wireless network.

6. Exit the WiFi Internet Adapter setup. Unplug the Ethernet cable between the WiFi Internet Adapter and the PC, and connect it to the AutoRAE 2 Controller.
7. Restart the AutoRAE 2 Controller.
8. Disable the PC's Ethernet port.
9. Enable the PC's Wi-Fi and connect the PC to the same wireless network as the WiFi Internet Adapter. (In this example, the wireless network used is RAEGN as shown in Figure 4.)
10. There are two ways to connect, using manual or automatic connection.
 - a. Manually.** Open the corresponding TCP/IP properties of the PC Wi-Fi (wireless) port. Manually set the IP address, subnet mask and default gateway as shown in Figure 4 for connection to the AutoRAE 2 Controller, which has DHCP disabled.
 - b. Automatically (DHCP enabled).** At the AR2 site, enter the AutoRAE 2 network setting menu. (See Figure 3.) Enable the DHCP function of the AutoRAE 2 Controller Ethernet port then exit to AR2 normal mode. Keep the PC wireless port setting as shown in Figure 3 (that is, set it to get the IP address automatically).

AutoRAE 2 User's Guide

9. Close the Windows Properties dialog box and wait for a few seconds. The PC will wirelessly connect to the AutoRAE 2 Controller.
10. Run ProRAE Studio II, which should be able to detect the AutoRAE 2 Controller via WiFi connection and communicate with the AutoRAE 2 Controller.



25. Wall Mounting A Controller & Cradles

The AutoRAE 2 can be used on a flat surface, or it can be mounted on a wall. This requires drilling holes into the wall and inserting screws to hold the AutoRAE 2.

Note: Handheld PID Cradles cannot be wall-mounted.

Important! Make sure the wall is strong enough to support the weight of the AutoRAE 2 Controller and attached AutoRAE 2 cradles. If necessary, mount a piece of plywood or use other reinforcement for the wall.

Use a pair of slotted TS35 DIN rails (35mm high x 7.5mm deep) cut to slightly longer than the length of the assembled system, and attach to a strong wall or other rigid surface using low-profile screws. Make sure the center-to-center spacing of the slotted rails is 135 mm.

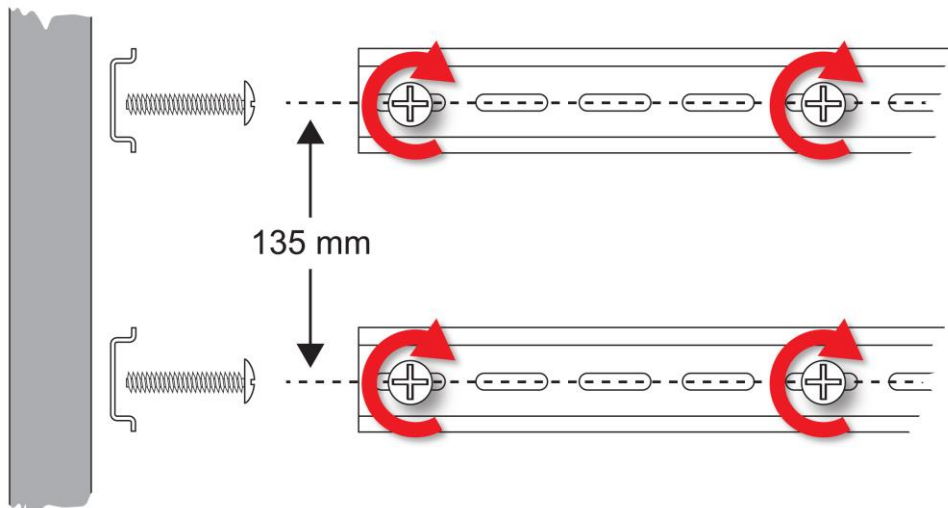

Once the rails have been firmly fastened to the wall, slide the AutoRAE 2 Controller from the left side onto the rails. Then slide an AutoRAE 2 Cradle onto the rails from the right side. Make sure that the last AutoRAE 2 Cradle has the Terminal Adapter from the AutoRAE 2 Controller attached.

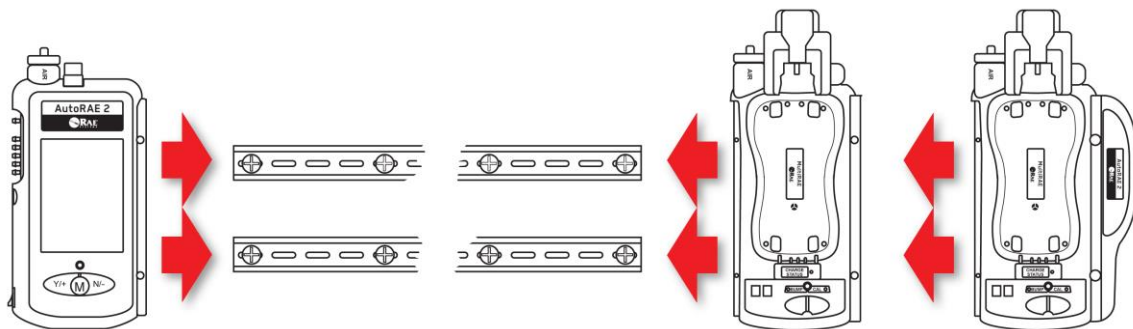

AutoRAE 2 User's Guide

Once all the AutoRAE 2 units have been slid onto the rails, press them together, insert the screws to secure them to each other, and then place the plastic caps over the screws. Refer to page 54 for assembly details.

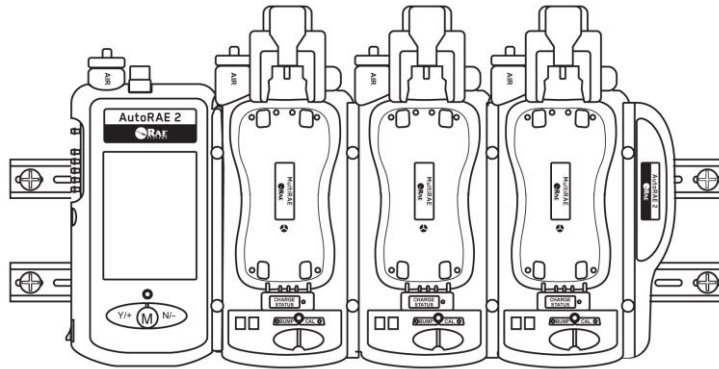

Make sure that the power cord and the AC Adapter, as well as all gas lines are properly protected from damage and tampering.

26. Transferring Bump And Calibration Data

Bump and calibration data is collected in the MultiRAE's datalog each time an instrument is bump tested or calibrated. To download the data, consult the MultiRAE User's Guide.

27. Maintenance

Occasional cleaning of the AutoRAE 2 Controller and AutoRAE 2 cradle exterior is recommended. Use a damp cloth (water only, no solvents or cleaners) to wipe the exterior case and the dock area. Do not use alcohol or solvents.

Inspect the ports in the dock and the space around and between the buttons and the case. If dirt has settled into any of these places, use a can of compressed air to blow it out.

Inspect the gas connections and make sure the tubing from gas cylinders is not damaged or cracked.

Inspect the optical sensor(s) on cradles to make sure they are clean. Dirty optical sensors may degrade testing performance for instruments' LED alarms, and may incorrectly cause an instrument to fail an alarm functional test while in the cradle.

Check the filters on the air inlets often, making sure that dirt and debris do not build up and affect performance.

Important! Never use sharp tools or solvents to dislodge small obstructions. If debris is lodged in any portion of the AutoRAE 2 Controller or AutoRAE 2 Cradle and cannot be removed by compressed air or soft cloth, refer it to qualified service personnel.

28. Technical Support

To contact RAE Systems Technical Support:

Monday through Friday, 7:00AM to 5:00PM Pacific (US) Time

Phone (toll-free): +1 877-723-2878

Phone: +1 408-952-8200

Fax: +1 408-952-8480

Email: RAE-tech@honeywell.com

29. RAE Systems Contacts

RAE Systems by Honeywell World Headquarters

3775 N. First St.

San Jose, CA 95134-1708 USA

Phone: +1 888-723-4800

E-mail: RAE-tech@honeywell.com

Web Site: www.raesystems.com

Training

Phone: +1 408-952-8260

Email: training@raesystems.com

Outside the Americas:

E-Mail: HZexpert@honeywell.com

Honeywell Analytics Ltd.

4 Stinsford Road

Nuffield Industrial Estate

Poole, Dorset, BH17 0RZ

United Kingdom

Tel: +44 (0) 1202 645 544

Fax: +44 (0) 1202 645 555

Honeywell Analytics

ZAC Athélia 4 – 375 avenue du Mistral

Bât B, Espace Mistral

13600 La Ciotat

France

Tel: +33 (0) 4 42 98 17 75

Fax: +33 (0) 4 42 71 97 05

Honeywell Analytics

Elsenheimerstrasse 43

80687 München

Germany

Tel: +49 89 791 92 20

Fax: +49 89 791 92 43

Honeywell Analytics

P.O. Box-45595

6th Street

Musaffah Industrial Area

Abu Dhabi

UAE

Tel: +971 2 554 6672

Fax: +971 2 554 6672



AutoRAE 2

User's Guide

CORPORATE HEADQUARTERS

RAE Systems by Honeywell

3775 North First Street

San Jose, CA 95134 USA

Phone: 408.952.8200

Fax: 408.952.8480

RAE-tech@honeywell.com

WORLDWIDE SALES OFFICES

USA/Canada 1.877.723.2878

Europe +800.333.222.44/+41.44.943.4380

Middle East +971.4.450.5852

China +86.10.5885.8788-3000

Asia Pacific +852.2669.0828