

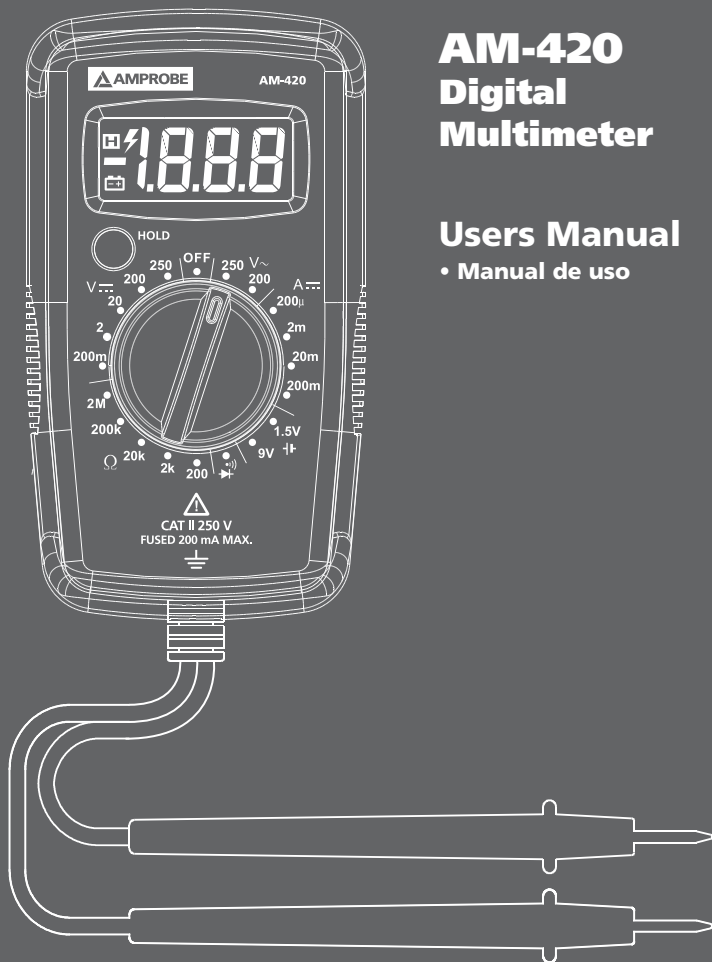

HARD AT WORK SINCE 1948.



AM-420 Digital Multimeter

Users Manual
• Manual de uso



AM-420

Digital Multimeter

Users Manual

English

Limited Warranty and Limitation of Liability

Your Amprobe product will be free from defects in material and workmanship for one year from the date of purchase unless local laws require otherwise. This warranty does not cover fuses, disposable batteries or damage from accident, neglect, misuse, alteration, contamination, or abnormal conditions of operation or handling. Resellers are not authorized to extend any other warranty on the behalf of Amprobe. To obtain service during the warranty period, return the product with proof of purchase to an authorized Amprobe Service Center or to an Amprobe dealer or distributor. See Repair Section for details. THIS WARRANTY IS YOUR ONLY REMEDY. ALL OTHER WARRANTIES - WHETHER EXPRESS, IMPLIED OR STATUTORY - INCLUDING IMPLIED WARRANTIES OF FITNESS FOR A PARTICULAR PURPOSE OR MERCHANTABILITY, ARE HEREBY DISCLAIMED. MANUFACTURER SHALL NOT BE LIABLE FOR ANY SPECIAL, INDIRECT, INCIDENTAL OR CONSEQUENTIAL DAMAGES OR LOSSES, ARISING FROM ANY CAUSE OR THEORY. Since some states or countries do not allow the exclusion or limitation of an implied warranty or of incidental or consequential damages, this limitation of liability may not apply to you.

Repair

All Amprobe returned for warranty or non-warranty repair or for calibration should be accompanied by the following: your name, company's name, address, telephone number, and proof of purchase. Additionally, please include a brief description of the problem or the service requested and include the test leads with the meter. Non-warranty repair or replacement charges should be remitted in the form of a check, a money order, credit card with expiration date, or a purchase order made payable to Amprobe.

In-warranty Repairs and Replacement – All Countries

Please read the warranty statement and check your battery before requesting repair. During the warranty period, any defective test tool can be returned to your Amprobe distributor for an exchange for the same or like product. Please check the "Where to Buy" section on www.Amprobe.com for a list of distributors near you. Additionally, in the United States and Canada, in-warranty repair and replacement units can also be sent to an Amprobe Service Center (see address below).

Non-warranty Repairs and Replacement – United States and Canada

Non-warranty repairs in the United States and Canada should be sent to an Amprobe Service Center. Call Amprobe or inquire at your point of purchase for current repair and replacement rates.

USA:

Amprobe

Everett, WA 98203

Tel: 877-AMPROBE (267-7623)

Canada:

Amprobe

Mississauga, ON L4Z 1X9

Tel: 905-890-7600

Non-warranty Repairs and Replacement – Europe

European non-warranty units can be replaced by your Amprobe distributor for a nominal charge. Please check the "Where to Buy" section on www.Amprobe.eu for a list of distributors near you.

Amprobe Europe*

Beha-Amprobe

In den Engematten 14

79286 Glottertal, Germany

Tel.: +49 (0) 7684 8009 - 0

www.Amprobe.eu

*(Correspondence only – no repair or replacement available from this address. European customers please contact your distributor.)





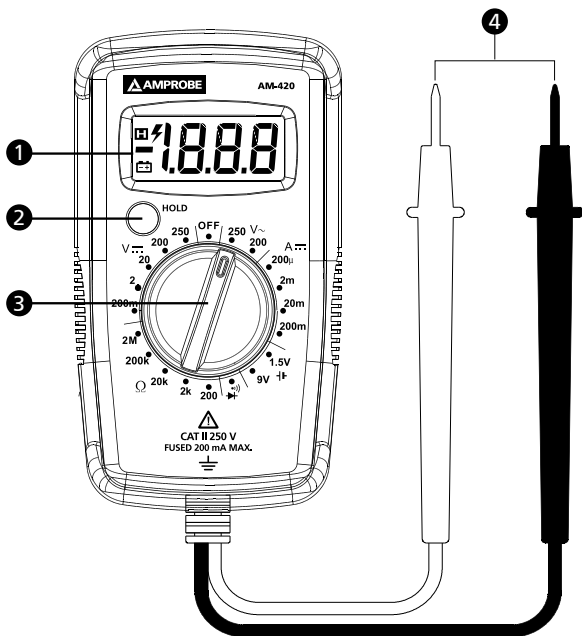





CONTENTS

SYMBOLS	2
SAFETY INFORMATION	3
UNPACKING AND INSPECTION	4
FEATURES	4
MAKING MEASUREMENTS	4
Rotary Switch Positions	4
HOLD Button	5
Measuring AC Voltage	6
Measuring DC Voltage	6
Measuring DC Current	7
Measuring Resistance	7
Measuring Continuity	7
Measuring Diode	7
Battery Test	7
DETAILED SPECIFICATIONS	8
MAINTENANCE	9
TROUBLESHOOTING	9
BATTERY AND FUSE REPLACEMENT	10



- | | |
|-----------------------|-------------------------|
| ① LCD display | ⑥ Display hold |
| ② Display HOLD button | ⑦ Negative reading |
| ③ Rotary switch | ⑧ Low battery indicator |
| ④ Test probe | ⑨ Measurement reading |
| ⑤ Hazardous voltage | |

SYMBOLS

	Caution! Risk of electric shock.
	Caution! Refer to the explanation in this manual.
	Alternating Current (AC).
	Direct Current (DC).
	The equipment is protected by double insulation or reinforced insulation.
	Earth (Ground).
	Battery.
	Complies with European Directives.
	Conforms to relevant Australian Standards
	Canadian Standards Association (NRTL/C)
	Do not dispose of this product as unsorted municipal waste. Contact a qualified recycler.

SAFETY INFORMATION

The Meter complies with:

IEC/EN 61010-1 3rd Edition, UL61010-1 2nd Ed. and CAN/CSA C22.2 No.

61010-1-04 + CSA Update No.1: 2008 to Category II 250 Volts, Pollution degree 2

IEC/EN 61010-2-030

IEC/EN 61010-2-31 for test leads

EMC IEC/EN 61326-1

"This product has been tested to the requirements of CAN/CSA-C22.2 No. 61010-1, second edition, including Amendment 1, or a later version of the same standard incorporating the same level of testing requirements".

Measurement Category II (CAT II) is for measurements performed on circuit directly connected to the low voltage installation. Examples are measurements on house hold appliances, portable tools and similar equipment.

CENELEC Directives

The instruments conform to CENELEC Low-voltage directive 2006/95/EC and Electromagnetic compatibility directive 2004/108/EC

Warning: Read Before Using

- *To avoid possible electrical shock or personal injury, follow these instructions and use the Meter only as specified in this manual.*
- *Do not use the Meter or test leads if they appear damaged, or if the Meter is not operating properly. If in doubt, have the Meter serviced.*
- *Always use the proper function and range for measurements.*
- *Before rotating the function range selection switch, disconnect test probe from circuit under test.*
- *Verify the Meter's operation by measuring on a known source.*

- *Do not apply more than the rated voltage, as marked on the Meter, between the test probe or between any test probe and earth ground.*
- *Use the Meter with caution for voltages above 30 Vac rms, 42 Vac peak, or 60 Vdc. These voltages pose electrical shock hazards.*
- *Disconnect circuit power and discharge all high-voltage capacitors before testing resistance, continuity and diode.*
- *Do not use the Meter around explosive gas or vapor.*
- *When using the test leads, keep your fingers behind the finger guards.*
- *Remove test leads from the Meter before opening the Meter's case.*
- *If the meter is used in a manner not specified in the users manual, the protection provided by the equipment may be impaired.*
- *To avoid injury, when the "battery low" indicator is present in the display, the product should NOT be used. A false measurement may occur. The battery should be replaced immediately.*

UNPACKING AND INSPECTION

Your shipping carton should include:

- 1 AM-420 Multimeter
- 1 9V alkaline battery (installed)
- 1 Users manual

If any of the items are damaged or missing, return the complete package to the place of purchase for an exchange.

FEATURES

Residential digital multimeter to check for voltage in receptacles, electrical circuits, fuses, light bulbs and electrical connections.



- Measurements: Voltage up to 250V AC/DC, DC Current and Resistance
- Special functions: Audible continuity and diode test
- Event: Data hold
- Low battery warning
- Safety: CAT II 250V

MAKING MEASUREMENT



1. Use the proper function and range for measurements.
2. To avoid possible electrical shock, personal injury or damages to the Meter, disconnect circuit power and discharge all high-voltage capacitors before testing resistance, continuity and diode.
3. Connecting test leads:
 - Connect the common (black) test lead to the circuit before connecting the live lead;
 - After measurement, remove live lead before removing the common (black) test lead from the circuit
4. Over-range indication: "1", "-1", or maximum display reading.

Rotary Switch Positions

Switch Position	Measurement Unit	Measurement Function	
V~	250	V AC	AC voltage measurement up to 250 V.
	200	V AC	AC voltage measurement up to 200 V.
V=	250	V AC	DC voltage measurement up to 250 V.
	200	V DC	DC voltage measurement up to 200 V.
	20	V DC	DC voltage measurement up to 200 V.
	2	V DC	DC voltage measurement up to 2 V.
A=	200m	mA DC	DC current measurement up to 200 mA.
	20m	mA DC	DC current measurement up to 20 mA.
	2m	mA DC	DC current measurement up to 2 mA.
	200μ	μA DC	DC current measurement up to 200 μA.
Ω	2M	MΩ	Resistance measurement up to 2 MΩ.
	200k	kΩ	Resistance measurement up to 200 kΩ.
	20k	kΩ	Resistance measurement up to 20 kΩ.
	2k	kΩ	Resistance measurement up to 2 kΩ.
	200	Ω	Resistance measurement up to 200 Ω.
	9V	V DC	For measurement of dry batteries of not exceeding 15 Vdc.
	1.5V	V DC	For measurement of dry batteries of not exceeding 2 Vdc.
		V DC	Voltage measurement of diode PN junction
		Ω	Continuity measurement, buzzer will sound when $\leq 10 \Omega$.

HOLD Button

Press HOLD button to freeze present reading on display. Press again to resume normal operation.

Warning

To avoid electric shock, do not use the HOLD mode to determine if a circuit is live. The Meter holds the reading on the display and does not refresh the reading automatically.

The "HOLD" button may be activated even when the product is **NOT** on (if "H" appears in the left-side of the display, HOLD is active). The HOLD function allows the meter to continue displaying the last reading, which may be "0". This reading will not change as long as the HOLD function is active, even if the meter is later connected to an energized circuit. "HOLD" can be disabled by pressing the "HOLD" button again. Readings will resume.

Measuring AC Voltage



Do not apply on a voltage source higher than AC 250V and use proper range for measurement. Over-range indication: "1", "-1" or a reading exceeds 250.

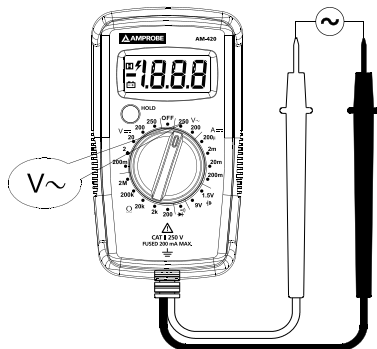

Measuring DC Voltage



Do not apply on a voltage source higher than DC 250V and use proper range for measurement. Over-range indication: "1", "-1" or a reading exceeds 250.

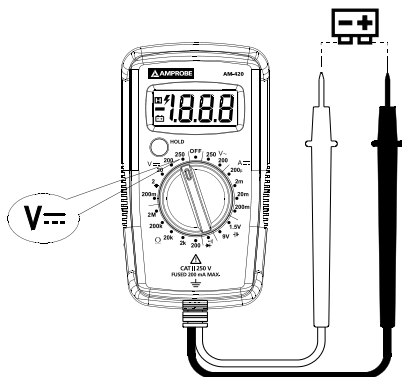

Measuring DC Current



To avoid personal injury or damage to the Meter:

1. Do not attempt to make an in-circuit current measurement when the open-circuit potential to earth ground exceeding 250V.
2. Switch to proper function and range for your measurement.
3. Do not place the test probe in parallel with a circuit when the test leads are connected to the current terminals.
4. Connect the test leads to the circuit before powering the circuit under test.
5. After measurement, switching OFF the circuit's power before removing test leads from the circuit.

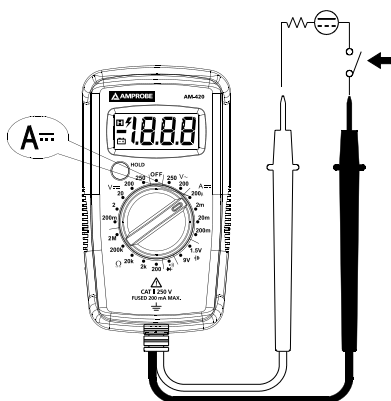

Measuring Resistance



Disconnect circuit power and discharge all high-voltage capacitors before testing resistance.

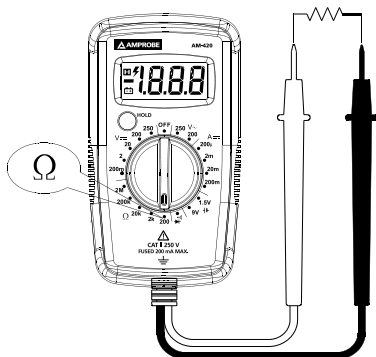

Measuring Continuity



Disconnect circuit power and discharge all high-voltage capacitors before testing continuity. Meter beeps at $\leq 10\Omega$, beeper turns off at $> 70\Omega$

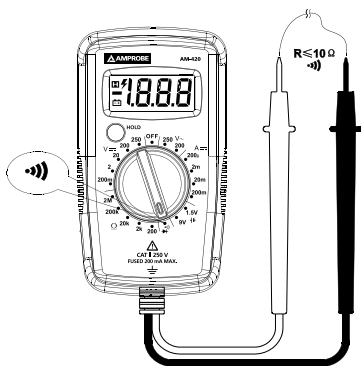

Measuring Diode



Disconnect circuit power and discharge all high-voltage capacitors before testing diode.

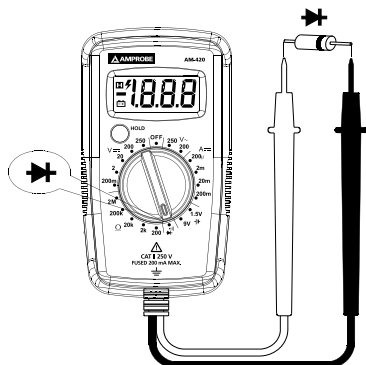

Battery Test



Applying a voltage source or incorrect battery type under battery test may cause personal injury or damage to the Meter.

Battery 1.5V range is for dry battery not exceeding 2Vdc. The resistance load is around 50Ω.

Battery 9V range is for dry battery not exceeding 15Vdc. The resistance load is around 1 k.

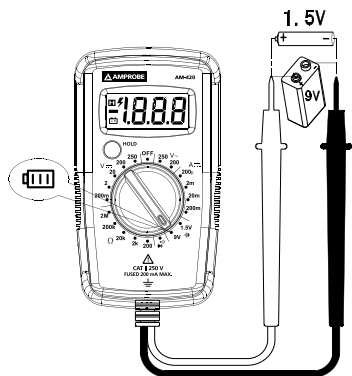

DETAILED SPECIFICATIONS

Ambient temperature: 23°C ± 5°C (73.4°F ± 9°F); **Relative temperature:** ≤ 75%

Accuracy: ± (% of reading + digits)

Maximum voltage between input terminal and earth ground: AC 250 Vrms or DC 250 V

 **Fuse:** F1 315 mA, H 250 V fast-fuse, (Φ5 × 20) mm

Maximum display: 1999, updates 2 to 3/sec

Over-range indication: " 1 ", "-1" or maximum display reading

Range: Manual ranging

Operating altitude: ≤ 2000 m

Operating temperature: 0°C to +40°C (32°F to 104°F)

Relative humidity: 0°C to +30°C (32°F to 86°F) ≤ 75%; +30°C to +40°C (86°F to 104°F) ≤ 50%

Storage temperature: -10°C to +50°C (14°F to 122°F)

Electromagnetic compatibility: In an RF field of 1V/m = Specified accuracy ± 5%.
RF field > 1V/m is not specified.

Power supply: One 9V alkaline battery (6LF22, 6LR61, MN1604) or equivalent

Low battery indication: 

Dimensions (L x W x H): 115 x 65 x 40 mm (4.5 x 2.6 x 1.6 in)

Weight: Approximately 275 g (0.61 lb) with battery installed

AC Voltage Measurement

Range	Resolution	Accuracy
200 V	0.1 V	±(1.5% + 4 LSD)
250 V	1 V	±(2.0% + 4 LSD)

Input impedance: around 0.5 MΩ

Frequency response: 45 Hz ~ 400 Hz

Overload protection: 250 VDC or AC rms

DC Voltage Measurement

Range	Resolution	Accuracy
200 mV	0.1 mV	±(1.2% + 2 LSD)
2 V	0.001 V	
20 V	0.01 V	
200 V	0.1 V	
250 V	1 V	±(1.5% + 2 LSD)

Input impedance: around 1 MΩ

Overload protection: 250 VDC or AC rms

DC Current Measurement

Range	Resolution	Accuracy
200 μA	0.1 μA	±(1.2% + 5 LSD)
2 mA	0.001 mA	±(2.5% + 4 LSD)
20 mA	0.01 mA	
200 mA	0.1 mA	

Overload protection: 250 V max.



 F1: 315 mA H 250 V fast-fuse, (Φ5x20)mm



Resistance Measurement

Range	Resolution	Accuracy
200Ω	0.1 Ω	±(1.5% + 5 LSD)
2 kΩ	0.001 kΩ	
20 kΩ	0.01 kΩ	
200 kΩ	0.1 kΩ	
2 MΩ	0.001 MΩ	±(2.0% + 4 LSD)

Open circuit voltage: around 3 VDC

Overload protection: 250 VDC or AC rms

 : Continuity  : Diode Measurement

Range	Resolution	Accuracy
	1 Ω	Open circuit voltage is around 3 VDC. Resistance >70Ω, buzzer will not sound. Resistance ≤10Ω, buzzer will sound. 11 < Resistance < 70, not specified.
	1 mV	Open-circuit voltage is around 1.5V. Normal voltage is around 0.5V to 0.8V for silicon PN junction.

Overload protection: 250 VDC or AC rms

Battery Test

Range	Resolution	Accuracy
1.5V	0.001 V	±(8.0% + 1 LSD)
9V	0.01 V	

For 1.5V range: Load resistance is around 50Ω.

For 9V range: Load resistance is around 1kΩ.

MAINTENANCE AND REPAIR

If the Meter fails to operate, check battery, test leads, etc., and replace as necessary.

Double check the followings

1. Replace the fuse or battery if the meter doesn't work.
2. Review the operating instructions for possible mistakes in operating procedure.

Except for the replacement of the fuse and battery, repair of the meter should be performed only by an authorized service center or by other qualified instrument service personnel.

The front panel and case can be cleaned with a mild solution of detergent and water. Apply sparingly with a soft cloth and allow to dry completely before using. Do not use aromatic hydrocarbons, Gasoline or chlorinated solvents for cleaning.

BATTERY AND FUSE REPLACEMENT

Warning

To avoid shock, injury, or damage to the Meter, disconnect the test lead from the measuring circuit before opening case. Use **ONLY** fuse with the amperage, interrupt, voltage, and speed ratings specified.

Replacing BATTERY and FUSE follow below steps:

1. Disconnect the test lead probe from measuring circuit.
2. Turn the Meter to OFF position.
3. Remove holster and the screws from the back cover, and then open the back cover.
4. Battery replacement: Remove the battery and replace with one 9 V Alkaline battery (6LF22, 6LR61, MN1604) or equivalent. Pay attention to the polarity signs.
5. Fuse replacement: Replace the broken fuse F1 with rating 315 mA H 250 V fast-fuse, ($\Phi 5 \times 20$)mm.
6. Put the back cover back, re-fasten the screw and install the holster back.

Battery: 9 V alkaline batteries (6LF22, 6LR61, MN1604) or equivalent

Fuse: 315 mA H 250 V fast-fuse, ($\Phi 5 \times 20$)mm

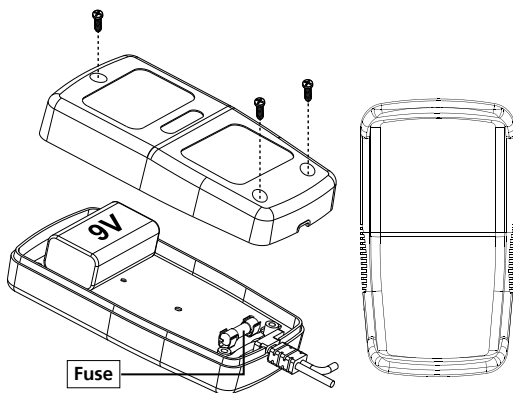

Visit www.Amprobe.com for

- **Catalog**
- **Application notes**
- **Product specifications**
- **User manuals**

Amprobe®

www.Amprobe.com

info@amprobe.com

Everett, WA 98203

Tel: 877-AMPROBE (267-7623)

Amprobe® Europe

Beha-Amprobe

In den Engematten 14

79286 Glottertal, Germany

Tel.: +49 (0) 7684 8009 - 0



Please
Recycle