

ASPYRE[®] **300A to 700A Power Controller**

User's Guide



1241 Bundy Boulevard., Winona, Minnesota USA 55987
Phone: +1 (507) 454-5300, Fax: +1 (507) 452-4507
<http://www.watlow.com>



1663-1873 Rev D



April 2019

Safety Information

We use note, caution and warning symbols throughout this book to draw your attention to important operational and safety information.







A “NOTE” marks a short message to alert you to an important detail.

A “CAUTION” safety alert appears with information that is important for protecting your equipment and performance. Be especially careful to read and follow all cautions that apply to your application.

A “WARNING” safety alert appears with information that is important for protecting you, others and equipment from damage. Pay very close attention to all warnings that apply to your application.

The safety alert symbol,  (an exclamation point in a triangle) precedes a general CAUTION or WARNING statement.

The electrical hazard symbol,  (a lightning bolt in a triangle) precedes an electric shock hazard CAUTION or WARNING safety statement. Further explanations follow:

Symbol	Explanation
	CAUTION - Warning or Hazard that needs further explanation than the label on unit can provide. Consult User's Guide for further information.
	Electrical Shock Hazard - Symbol (a lightning bolt in a triangle) precedes an electric shock hazard CAUTION or WARNING safety statement.
	ESD Sensitive product, use proper grounding and handling techniques when installing or servicing product.
	Do not throw in trash, use proper recycling techniques or consult manufacturer for proper disposal.
	Unit is a Listed device per Underwriters Laboratories. It has been investigated to ANSI/UL® 508 standards for Industrial Control Switches and equivalent to CSA C22.2 #14. For more detail search for File E73741 on www.ul.com .
	Unit is compliant with European Union directives. See Declaration of Conformity for further details on Directives and Standards used for Compliance.

 **WARNING!** To avoid damage to property and equipment, injury and loss of life, adhere to applicable electrical codes and standard wiring practices when installing and operating this product. Failure to do so could result in damage, injury and death.

 **WARNING!** All service including inspection, installation, wiring, maintenance, troubleshooting, fuse or other user-serviceable component replacement must be performed only by properly qualified personnel. Service personnel must read this manual before proceeding with work. While service is being performed other, unqualified personnel should not work on the unit or be allowed in the immediate vicinity.

 **WARNING!** When in use the power controller is connected to dangerous voltages. Do not remove the protective covers without first disconnecting and preventing power from being restored while servicing the unit.

 **WARNING!** Do not use in aerospace or nuclear applications.

 **WARNING!** The power controller's protection rating is IP20 with all covers installed and closed. It must be installed in an enclosure that provides all the necessary additional protections appropriate for the environment and application.

 **WARNING!** Ground the power controller via the provided protective earth grounding terminal. Verify ground is within impedance specifications. This should be verified periodically.

 **WARNING!** Electric Shock Hazard: when the power controller has been energized, after shutting off the power, wait at least one minute for internal capacitors to discharge before commencing work that brings you in to contact with power connections or internal components.

 **WARNING!** The installation must be protected by electromagnetic circuit breakers or by fuses. The semiconductor fuses located inside the power controller are classified for UL[®] as supplementary protection for semiconductor devices. They are not approved for branch circuit protection.

 **WARNING!** When making live voltage or current measurements, use proper personal protective equipment for the voltages and arc-flash potentials involved.

 **WARNING!** Verify the voltage and current ratings of the power controller are correct for the application.

 **CAUTION:** To avoid compromising the insulation, do not bend wire or other components beyond their bend radius specifications.

 **CAUTION:** Protect the power controller from high temperature, humidity and vibrations.

 **CAUTION:** The power controller warranty is void if the tested and approved fuses are not used.

 **CAUTION:** Only trained and authorized personnel should access and handle the internal electronics and they must follow proper electro-static prevention procedures.

 **CAUTION:** Install an appropriately sized RC filter across contactor coils, relays and other inductive loads.

 **NOTE!** Provide a local disconnect to isolate the power controller for servicing.

 **NOTE!** The nominal current is specified for ambient temperatures at or below 40° C. Ensure the application design allows for adequate cooling of each power controller. The power controller must be mounted vertically. The cooling design must prevent air heated by one power controller from causing power controllers mounted above to exceed the ambient operating temperature limit. When power controllers are mounted side by side allow a minimum spacing of 15mm between them.

 **NOTE!** Use only copper cables and wires rated for use at 75° C or greater.

 **AVERTISSEMENT!** Tous les services, y compris l'inspection, l'installation, le câblage, l'entretien, le dépannage, le remplacement de fusibles ou d'autres composants pouvant être réparés par l'utilisateur, doivent être effectués uniquement par un personnel dûment qualifié. Le personnel de service doit lire ce manuel avant d'effectuer tout travail. Pendant que l'entretien est exécuté, tout personnel non qualifié ne doit effectuer de travail sur l'appareil ni se trouver à proximité.

 **AVERTISSEMENT!** Pour éviter d'endommager la propriété et l'équipement, les blessures et la perte de vie, respecter les codes électriques en vigueur et les pratiques de câblage standard au moment de l'installation et de l'utilisation de ce produit. Dans le cas contraire, cela peut entraîner la mort, des blessures graves ou des dommages.

 **AVERTISSEMENT!** Au moment de l'utilisation, le régulateur de puissance est connecté à des tensions dangereuses. Ne retirer aucun couvercle de protection sans d'abord débrancher l'appareil et ainsi empêcher l'alimentation d'être rétablie pendant l'entretien.

 **AVERTISSEMENT!** Ne pas utiliser pour les applications aérospatiales ou nucléaires.

 **AVERTISSEMENT!** L'indice de protection du régulateur de puissance est de IP20 lorsque les couvercles sont installés et fermés. L'appareil doit être installé dans une enceinte qui assure toute la protection supplémentaire nécessaire pour l'environnement et l'application.

 **AVERTISSEMENT!** Mise à la terre du régulateur de puissance par le biais de la borne de prise de terre de protection fournie. Vérifier que la prise de terre est conforme aux spécifications de l'impédance. Cela doit être vérifié périodiquement.

 **AVERTISSEMENT!** Risque de décharges électriques : lorsque le régulateur de puissance est mis sous tension, après avoir été éteint, attendre au moins une minute pour que les condensateurs internes se déchargent avant de commencer tout travail incluant le contact avec les connexions électriques ou les composants internes.

 **AVERTISSEMENT!** L'installation doit être protégée par des disjoncteurs électromagnétiques ou des fusibles. Les fusibles pour semi-conducteurs situés à l'intérieur du régulateur de puissance sont classés UL® comme protection supplémentaire pour les dispositifs pour semi-conducteurs. Ils ne sont pas approuvés pour la protection des circuits de dérivation.

 **AVERTISSEMENT!** Au moment de relever des mesures de tension ou de courant en direct, utiliser un équipement de protection individuelle approprié pour les tensions et les potentiels d'arc électrique concernés.

 **AVERTISSEMENT!** Vérifier que les valeurs de tension et de courant du régulateur de puissance sont correctes pour l'application.

 **ATTENTION :** Pour éviter de compromettre l'isolation, ne pas plier le fil ou tout autre composant au-delà de ses spécifications en matière de rayon de courbure.

 **ATTENTION :** Protéger le régulateur de puissance contre les températures élevées, l'humidité et les vibrations.

 **ATTENTION :** La garantie du régulateur de puissance est nulle si aucun fusible testé et approuvé n'est utilisé.

 **ATTENTION :** Seul le personnel formé et autorisé peut accéder aux composants électroniques internes et les gérer, et il doit se conformer à des procédures de prévention électrostatique appropriées.

 **ATTENTION :** Installer un filtre RC de dimensions appropriées sur les bobines du contacteur, les relais et autres charges par induction.

⚠️ REMARQUE : Fournir une déconnexion locale afin d'isoler le régulateur de puissance pour l'entretien.

⚠️ REMARQUE : Le courant nominal est précisé pour des températures ambiantes égales ou inférieures à 40°C. S'assurer que la conception de l'application permette le refroidissement adéquat de chaque régulateur de puissance. Le régulateur de puissance doit être monté verticalement. La conception de refroidissement doit empêcher l'air chauffé par le régulateur de puissance de dépasser la limite de température de fonctionnement ambiante de la part des régulateurs de puissance montés au-dessus. Lorsque les régulateurs de puissance sont montés côte à côte, il faut conserver un espacement minimal de 15 mm entre les deux.

⚠️ REMARQUE : N'utiliser que des câbles et des fils en cuivre pour l'utilisation à 75°C ou plus.

Technical Assistance

If you encounter a problem with your Watlow® controller, review your configuration information to verify that your selections are consistent with your application: inputs, outputs, alarms, limits, etc. If the problem persists, you can get technical assistance from your local Watlow representative (see back cover), by e-mailing your questions to wintechsupport@watlow.com or by dialing +1 (507) 494-5656 between 7 a.m. and 5 p.m. Central Time USA & Canada. Ask for for an Applications Engineer. Please have the complete model number available when calling.

Return Material Authorization (RMA)

1. Call Watlow Customer Service, (507) 454-5300, for a Return Material Authorization (RMA) number before returning any failed product to Watlow. If you do not know why the product failed, contact an Application Engineer. All RMA's require:
 - Ship-to address
 - Bill-to address
 - Contact name
 - Phone number
 - Method of return shipment
 - Your P.O. number
 - Detailed description of the problem
 - Any special instructions
 - Name and phone number of person returning the product
2. Prior approval and an RMA number from the customer service department is required when returning any product. Make sure the RMA number is on the outside of the carton and on all paperwork returned. Ship on a freight prepaid basis.
3. After we receive your return, we will examine it to verify the reason for the product failure. Unless otherwise agreed to in writing, Watlow's standard warranty provisions, which can be located at, www.watlow.com/terms, will apply to any failed product.
4. In the event that the product is not subject to an applicable warranty, we will quote repair costs to you and request a purchase order from you prior to proceeding with the repair work.
5. Watlow reserves the right to charge for no trouble found (NTF) returns.

Warranty

The ASPYRE® power controller is warranted by Watlow® for a period of 36 months in accordance with the terms and conditions set forth on Watlow's website, which may be accessed at www.watlow.com/terms.

Document Number: 10-05823 Rev D

©2019 Watlow Electric Manufacturing Company, all rights reserved.

Watlow® and ASPYRE® are registered trademarks of Watlow Electric and Manufacturing Company.

Cooper Bussman® is a registered trademark of Cooper Industries Inc.

EtherNet/IP™ is a trademark of Open DeviceNet Vendors Association.

Kanthal® is a registered trademark of Bulten-Kanthal Aktiebolag Joint Stock Company

Windows® is a registered trademark of Microsoft Corporation.

Modbus® is a registered trademark of Schneider Automation Incorporated.

Siemens® is a registered trademark of Siemens Aktiengesellschaft Corporation.

UL® is a registered trademarks of Underwriter's Laboratories, Inc.



Contents

- Safety Information 2
- Technical Assistance 5
- Return Material Authorization (RMA) 5
- Warranty 5
- Overview 11**
 - Recognizing Product Features 11
 - Identifying the Product 11
 - Product Selection 12
 - Features and Benefits 14
 - Product Block Diagram 15
- Installation 17**
 - Installing the ASPYRE Power Controller 17
 - Environmental Conditions 17
 - Cooling Requirements 18
 - Mounting Dimensions 19
- Wiring 21**
 - Wiring the ASPYRE Power Controller 21
 - Good Wiring Practices 21
 - Wiring Overview Diagrams 22
 - Wire Selection, Prep and Torque 23
 - Removing the Covers 24
 - Connecting Control Signals 25
 - Powering the Cooling Fans 29
 - Connecting the Auxiliary Power 29
 - Wiring the Line Power and Load 30
- Initial Setup 31**
 - Using the ASPYRE Configurator Software 31
 - Configuring the ASPYRE Power Controller 31
- Operation 35**
 - Control Panel 35
 - Menu Navigation 36
 - Indicators (LEDs) 37
 - Alarms and Messages 38
- Using ASPYRE Configurator 39**
 - Overview 39
 - How To 39
 - Reference 44
- Parameter Reference 53**
 - Alarm Function 53

Analog In 1 [Signal Type]	53
Analog In 1 [Value]	54
Analog In 2 [Signal Type]	54
Analog In 2 [Value]	54
Analog In 2 Function	54
Aux Voltage	54
Bakeout Current (Models with Current Limit)	54
Bakeout Off Time (Models with Current Limit)	55
Bakeout Ramp Time (Models with Current Limit)	55
Command Bits	55
Cycle Time	56
Delay	56
Digital In 1	56
Digital In 1 Function	56
Digital In 2	57
Digital In 2 Function	57
Enable	57
Ethernet Address	57
Ethernet Subnet	58
Ethernet Gateway	58
Feedback	58
Firing	58
Frequency	59
Half Cycles to Delay	59
Heater Bakeout (Models with Current Limit)	59
HH:MM:SS	59
Host Name	59
Htr Break Delay	59
Htr Break Sensitivity	59
I Limit (Models with Current Limit)	60
I Limit Local / Remote (Models with Current Limit)	60
I Output	60
Integral Current (Models with Current Limit)	60
Integral Power	60
kVA Real Time	60
kW Real Time	60
kW Total	61
Leg 1 I Output (DT2 and DT3 Models)	61
Leg 2 I Output (DT2 and DT3 Models)	61
Leg 3 I Output (DT2 and DT3 Models)	61
Limit Peak Current (Models with Current Limit)	61
Load Ω	61
Logging	61
Logging Interval	62
Max Current	62
Max Voltage	62
Min Cycles	62
MM/DD/YY	62

Neutral Connected (DT2 and DT3 Models)	62
Nominal I	62
Nominal V	63
Out Scale	63
Port 1 Address	63
Port 1 Baud	63
Port 2	63
Port 2 Access	64
Port 2 Address	64
Port 2 Baud	64
Power	64
Power Factor	64
Prop Band Current (Models with Current Limit)	64
Prop Band Power	65
Release	65
Remote SP	65
Retransmit (Models with Retransmit)	65
Retransmit Scale (Models with Retransmit)	66
Retransmit Type (Models with Retransmit)	66
Safety Ramp Duration	66
Safety Ramp Off Time	66
SCR Temperature	67
Serial Number	67
Set Point	67
Set Point Source	67
Soft Start	67
Start Ramp	67
Startup Display	68
Status Bits	68
Thermal Alarm Counter	68
Unit Type	68
User Access Level	69
V Input	69
V Output	69
Version	69
Watchdog	69
Watchdog Reset Time	69
Wi-Fi	70
Wi-Fi Address	70
Features	71
Closed Loop Control	71
Feedback	72
Current Limit	74
Configurable Inputs and Outputs	74
Firing Types	76
Soft Start	82
Start Ramp (DT1 and DT3 Models)	82

Safety Ramp (DT1 and DT3 Models)	83
Heater Bakeout Function (Models with Current Limit)	83
Totalizer	83
Data Logging	84
Maintenance & Troubleshooting	85
Routine Maintenance	85
Alarms and Indicators	85
Removing the Covers	87
Replacement Fuses	88
Replacing the Battery	89
Calibration Procedures	89
Updating the Firmware	91
Troubleshooting	92
Troubleshooting Schematics	93
Communication	97
Overview	97
Enabling the Secondary Port	98
Ethernet Network Setup	98
Modbus® TCP	99
EtherNet/IP™ Setup	99
Profinet IO Setup	102
Profibus DP Setup	107
Holding Registers	113
Input Registers	114
Modbus® RTU	116
Modbus® RTU Holding Registers	117
Specifications	121
Declaration of Conformity	127

1

Overview

This chapter describes how to locate the model number of the ASPYRE® power controller, explains how to determine which ordering options are present, identifies its physical features, lists its main functional features and benefits and provides a functional overview in the form of a block diagram.

Recognizing Product Features

This illustration indicates the physical features of the product as referenced in this manual.



Identifying the Product

To identify the power controller, locate the part number on the product identification label, see the illustration. With the part number and the part number table you can determine important characteristics of the power controller.

Product Identification Label

The product identification label includes not only the part number but also the voltage and current ratings and auxiliary and fan voltage requirements.

Sample Label

Max. Load Current: 300A	Use Wire rated 75°C, Max Ambient 40°C For use in Pollution Degree 2 Environment User Manual: 1663-1873	 IND. CONT. EQ. E73741 2RD5
Max. Load Voltage: 600Vac ~ 50/60Hz		
Auxiliary Voltage : 540-660Vac ~ 50/60Hz 6VA		
Fan Voltage : 120 VAC		
Second Port : Modbus TCP		
1 Phase 1 Leg Control		

Part Number

1 2	3	4 5 Max. Line & Load Voltage	6 7 8	9 Nominal Voltage Supplied to SCR	10 Additional Options	11 Cooling Fan Voltage	12 Add'l Wired Comms.	13 Wireless Comm. & Data Logging	14 15 Custom Options - Firmware Overlay, Preset Parameters and Locked Code
DT									

3	Phase
1 =	1-phase, 1 controlled leg
2 =	3-phase, 2 controlled leg
3 =	3-phase, 3 controlled leg

4 5	Maximum Line and Load Voltage
48 =	480VAC
60 =	600VAC
69 =	690VAC - Only available for 60A and greater models

6 7 8	Amperage
035 =	35A
040 =	40A
060 =	60A
090 =	90A
120 =	120A
150 =	150A
180 =	180A
210 =	210A
300 =	300A
350 =	350A - Not available for 1-phase, 1 leg or 3-phase, 2 leg models
400 =	400A
450 =	450A - Not available for 1-phase, 1 leg models
500 =	500A
600 =	600A - Not available for 3-phase, 3 controlled leg models
700 =	700A - Not available for 3-phase, 3 controlled leg models

9	Nominal Voltage Supplied to SCR	
	Nominal	Maximum Operating Range
1 =	100 or 120VAC	90-135V
2 =	200, 208, 220, 230 or 240VAC	180-265V
3 =	277VAC	249-305V
4 =	380, 400, 415, 440 or 480VAC	342-528V
5 =	600VAC	540-660V
6 =	690VAC*	621-759V

* 690VAC only available for 60A and greater models.

10	Additional Options	
	Current Limit Loop	Analog Retransmit Output 1
A =	Yes	Yes
B =	No	No
C =	Yes	No
D =	No	Yes

Note 1: Current limit loop only available with 1-phase and 3-phase, 3-leg models (DT1 and DT3). Exception: Current limit not available with the 35A and 40A, 3-phase, 3-leg models (DT3xx-035xx-xxxx and DT3xx-040xx-xxxx).

Note 2: If using both Analog Retransmit (digit 10, options A or D) and Additional Wired Communication (digit 12, options 1-5) an external power supply will be required. Watlow power supply part number: 0847-0299-0000 Descriptions: AC/DC power supply converter for 90-263VAC to 24VDC, 1.30A, 31W.

11	Cooling Fan Voltage
0 =	No fan - option only valid for models ≤60A
1 =	120VAC*
2 =	240VAC*
3 =	24VDC*

* Fan voltage required on models ≥90A, not valid option for models ≤60A.

12	Additional Wired Communication (Modbus® RTU-485 Comes Standard in all Models)					
	No Add'l Comms.	Modbus® TCP	2 nd Modbus® RTU 485	Profibus DP	Profinet	EtherNet/IP™
0 =	X					
1 =		X				
2 =			X			
3 =				X		
4 =					X	
5 =						X

Note 1: All additional communication options include auxiliary 24VDC backup power supply for communications.

Note 2: If using both Analog Retransmit (digit 10, options A or D) and Additional Wired Communication (digit 12, options 1-5) an external power supply will be required. Watlow power supply part number: 0847-0299-0000 Descriptions: AC/DC power supply converter for 90-263VAC to 24VDC, 1.30A, 31W.

13	Wireless Communications & Data Logging	
	Wi-Fi	*Data Logging With Battery Back-Up and Real Time Clock
A =		
B =	X	
C =		X
D =	X	X

* 40A and lower models do not include battery back-up or real time clock.

14 15	Custom Options - Firmware Overlay, Preset Parameters and Locked Code
AA =	Standard with user manual documentation
AB =	Standard without user manual documentation
RC =	Replacement connector hardware only - for configuration entered above
XX =	Contact factory - custom firmware, preset parameters, locked code

! NOTE! No UL® on 690V models.

Product Selection

This section describes how to choose the appropriate ordering options.

Digit 3, Phase

Choose the number of switched legs. Ungrounded-wye and delta loads are most economically controlled with two-leg switching. Grounded-wye and open-delta loads require three-leg switching.

Digits 4 and 5, Maximum Line and Load Voltage

Choose the lowest voltage range that is equal to or greater than the nominal voltage supplied to the ASPYRE power controller. The actual voltage is specified with digit 9.

Digits 6, 7 and 8, Amperage

These digits indicate the maximum current that can be switched. Choose a power controller with adequate current capacity for your load. Use one of the formulas below to determine the nominal load current based on the load configuration, the line voltage and the load power or resistance.

In the formulas below:

- I is the nominal load current calculated according to the formula
- P is the total power of the load
- R is the resistance of each heating element
- V is the nominal voltage supplied to the ASPYRE power controller (see the 9th digit in the part number)

Single Phase Resistive Load

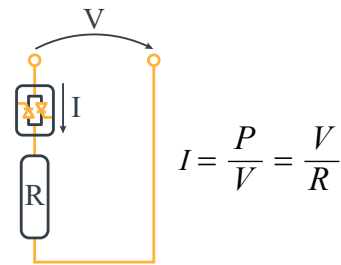

2-Leg, 3-Phase Resistive Load in Wye Configuration

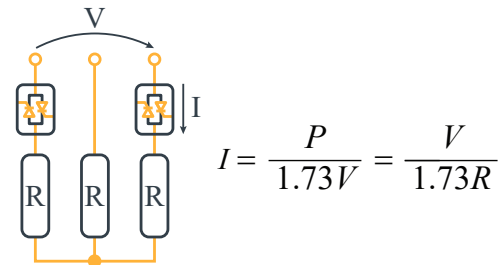

2-Leg, 3-Phase Resistive Load in Delta Configuration

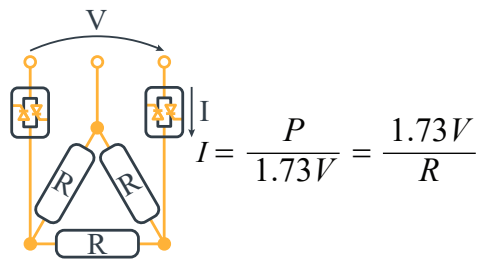

3-Leg, 3-Phase Resistive Load in Wye Configuration

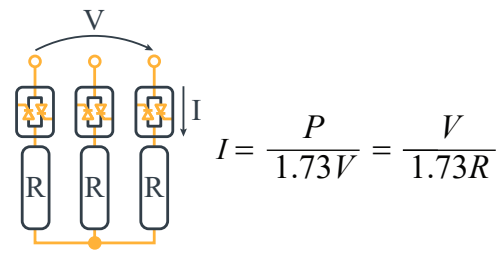

3-Leg, 3-Phase Resistive Load in Grounded Wye Config.

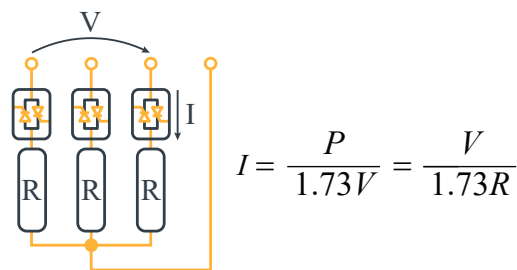

3-Leg, 3-Phase Resistive Load in Delta Configuration

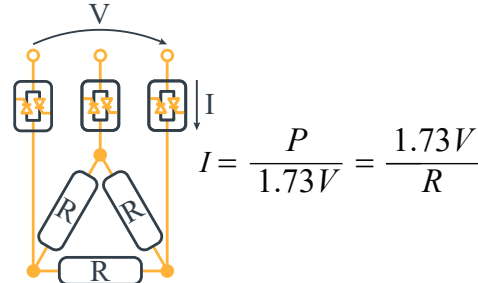

3-Leg, 3-Phase Resistive Load in Open Delta Config.

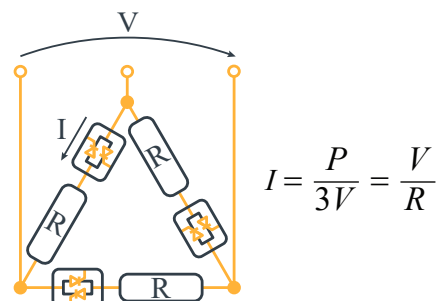

Digit 9, Nominal Voltage Supplied to SCR

Choose the voltage that will be used to power the load. This is also the voltage for the auxiliary power supply input. The voltage chosen here must be less than or equal to the Maximum Line and Load Voltage chosen with digits 4 and 5.

Digit 10, Current Limit Loop and Analog Retransmit Output 1*

Choose if the power controller limits current and/or can retransmit load voltage, current, power or measured input. The current limit option is available only with single phase and three-phase, three-leg models.

Digit 11, Cooling Fan Voltage

For power controllers that switch 90A or more, choose the voltage you will supply to power the fans in the ASPYRE power controller. Models that switch less than 90A do not require or include cooling fans.

Digit 12, Additional Wired Communication Option*

If desired, choose an optional communication port in addition to the EIA-485, Modbus® RTU port that comes standard on all models.

Digit 13, Wireless Communication and Data Logging Option

Choose the desired combination of Wi-Fi and data logging options.

Characters 14 and 15, Custom Options

Choose the desired options or use a factory supplied two-character option.

*If using both analog retransmit (digit 10, options A or D) and additional wired communication (digit 12, options 1 to 5) an external power supply is required.

Features and Benefits

This section provides a high-level overview of the features and benefits of the ASPYRE power controller.

Heater bakeout

- Protects heater upon start up
- Eliminates labor and time associated with checking for wet heaters

Integrated semiconductor fusing, current transformer and user interface

- Saves installation time and eases setup and commissioning
- Delivers a user-friendly, intuitive interface

Industry-leading design and serviceability

- Offers a robust SCR design to meet a rugged industrial environment's high quality and reliability needs
- Provides quick and easy access to maintain and service fuses and individual legs in minimal time
- Enables fast troubleshooting by providing helpful thermal system diagnostics

Comprehensive power controller range

- Provides wide range of options from simple single phase to complex three-phase loads to 690V

100KA short circuit current rating (SCCR)

- Enables greater protection in the event of a short circuit

c-UL® 508 Listed

- Shortens project schedules, agency testing and expenses

Control modes: contactor, voltage, current or power

- Satisfies a wide range of demanding thermal applications

Load firing modes: zero-cross, burst fire, phase angle, soft start, half-cycle, single-cycle, delayed triggering

- Handles a wide range of load types including nichrome, medium and long waveform infrared lamps, moly, transformers, silicon carbide, UV lamps and tungsten
- Protects and extends the life of connected loads

Wide range of communication protocols

- Enable factory and process automation with connectivity to process and equipment data via Modbus® RTU, Modbus® TCP, EtherNet/IP™, Wi-Fi, Profibus, Profinet, USB device (configuration and data file transfers)

Open heater and shorted SCR indication

- Minimizes production downtime with easy to understand, intelligent, troubleshooting diagnostics

Integrated USB and user interface for configuration

- Easily and safely program configuration settings as the user interface can be powered through USB connection
- Eliminates need to work in a high voltage hazard environment. High voltage to the power controller and system panel can be shut off and locked out for safety while configuring controller.

Product Block Diagram

This diagram represents the features and functions of the ASPYRE power controller in a graphical format showing the relationships between various functions. Optional features are indicated.

Product Block Diagram for 300A to 700A Models

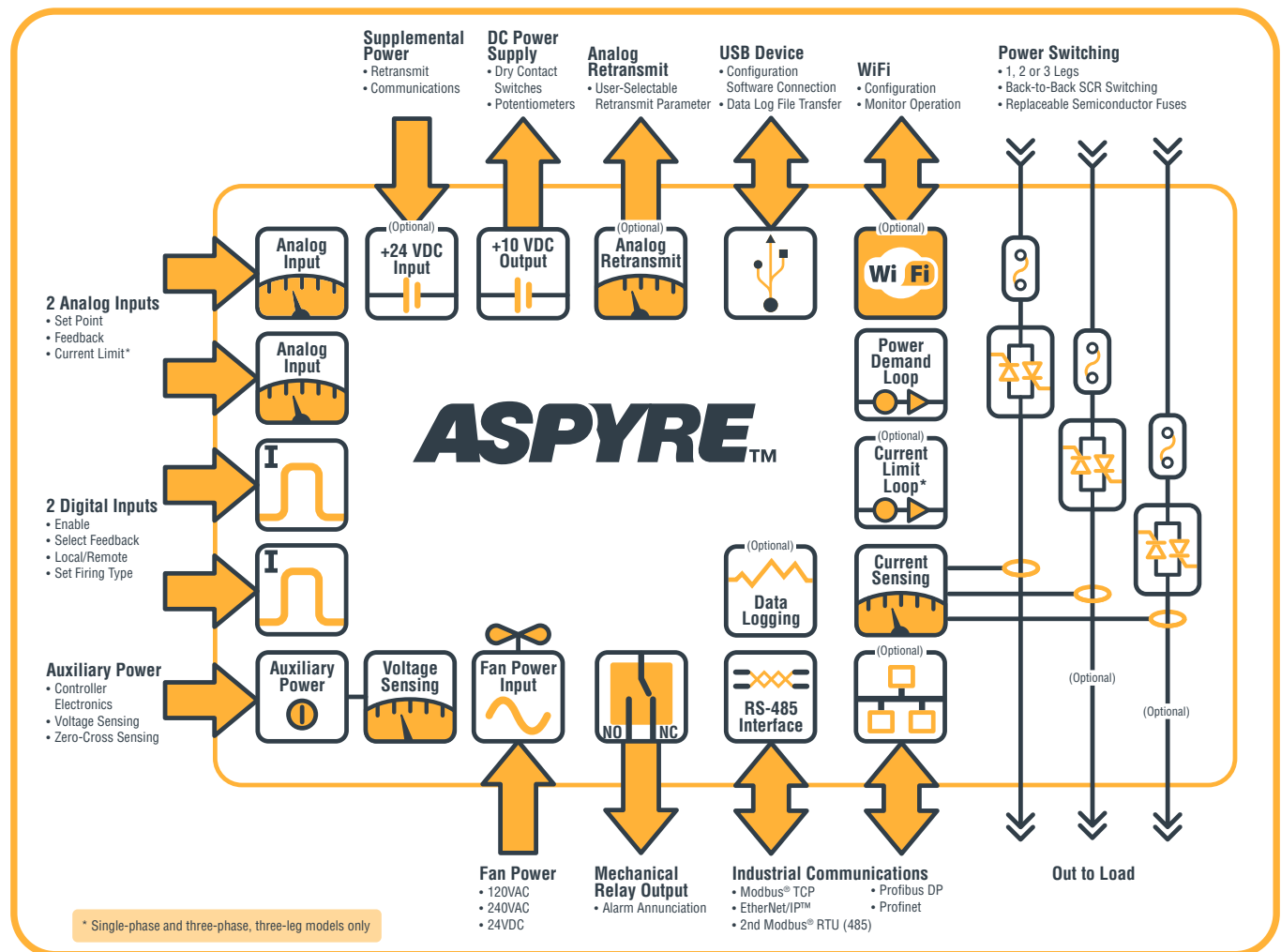

Wi-Fi Transmitter Module

Models DT____-____-_____[B or D]__ contain a Wi-Fi transmitter module. See the label on the module to determine which of the following modules is installed. The transmitter module is mounted on the top of the microprocessor board visible when the center cover is tipped forward.

Module FCC ID: 2ADUIESP-12-F WiFi module 802.11b/g/n 2412-2462 MHz

Output power:

- 802.11b: 15.58 dBm (Max.)
- 802.11g: 13.72 dBm (Max.)
- 802.11n: 12.53 dBm (Max.)

Antenna gain: 1.0 dBi PCB antenna 11 channels.

Module FCC ID: 2AL3B-ESP-F 802.11b/g/n 2412-2462 MHz

Output power:

- 802.11b: 14.0 dBm (Max.)
- 802.11g: 12.8 dBm (Max.)
- 802.11n: 13.6 dBm (Max.)

Antenna gain: 1.0 dBi PCB antenna 11 channels.

Unit is assembled from tested components, complete system not tested.

This equipment has been tested and found to comply with the limits for a Class B digital device, pursuant to Part 15 of the FCC Rules. These limits are designed to provide reasonable protection against harmful interference in a residential installation. This equipment generates, uses and can radiate radio frequency energy and, if not installed and used in accordance with the instructions, may cause harmful interference to radio communications. However, there is no guarantee that interference will not occur in a particular installation.

If this equipment does cause harmful interference to radio or television reception, which can be determined by turning the equipment off and on, the user is encouraged to try to correct the interference by one or more of the following measures:

- Reorient or relocate the receiving antenna.
- Increase the separation between the equipment and receiver.
- Connect the equipment into an outlet on a circuit different from that to which the receiver is connected.
- Consult the dealer or an experienced radio/TV technician for help.

2

Installation

 **WARNING:** To avoid damage to property and equipment, injury and loss of life, adhere to applicable electrical codes and standard wiring practices when installing and operating this product. Failure to do so could result in damage, injury and death.

 **AVERTISSEMENT!** Pour éviter d'endommager la propriété et l'équipement, les blessures et la perte de vie, respecter les codes électriques en vigueur et les pratiques de câblage standard au moment de l'installation et de l'utilisation de ce produit. Dans le cas contraire, cela peut entraîner la mort, des blessures graves ou des dommages.

Installing the ASPYRE Power Controller

This chapter provides the information necessary to select and prepare a location and to mount one or more ASPYRE power controllers.

Consider the spacing required for power, load, and control signal wiring before mounting the power controller. Take in to account the controller dimensions, wire bending radius, and cooling requirements. Use good wiring practices to minimize electrical noise problems.

Peripheral Components

Allow room for fuses and fuse holders for the auxiliary input power and fans (if present).

Mounting Orientation

Mount power controllers vertically.

Bend Radius

Allow adequate space to route cables without requiring bending more than permitted for the type of cable.

Environmental Conditions

Mount ASPYRE power controllers in a suitable electrical enclosure. Allow adequate wire bending space and cooling. The maximum ambient temperature in the enclosure must not exceed 104°F (40°C).

Ambient Temperature	32° to 104°F (0° to 40°C)
Storage Temperature	-13° to 158°F (-25° to 70°C)
Installation Location	Install away from direct sun light, conductive dust, corrosive gas, vibration, water and corrosive salts.
Altitude	Up to 6560 feet (2000m) above sea level At altitudes above 3280 feet (1000m) reduce the nominal current by 2% for each 328 feet (100m).
Humidity	From 5 to 95% relative humidity, non-condensing and without ice
Pollution degree	Installation Category III, Pollution degree 2

Cooling Requirements

To maintain the ambient temperature in the enclosure in which the power controller, circuit breakers, fuses and other components are installed, there must be adequate cooling to remove the heat generated by all the devices. The power controllers are designed to be cooled by drawing cool air in from the bottom and expelling heated air at the top. Typically cabinets are designed with one or more fans on the front door or on the top of the enclosure. The designer will need to know the heat generated by the power controller. See the table below.

Total Heat Generated by ASPYRE Power Controller

Model	Current (A)	Switched Legs	Generated Heat (W)
DT1__-300...	300	1	443
DT1__-400...	400	1	547
DT1__-500...	500	1	591
DT1__-600...	600	1	832
DT1__-700...	700	1	945
DT2__-300...	300	2	903
DT3__-300...	300	3	1324
DT3__-350...	350	3	1439
DT2__-400...	400	2	1092
DT3__-400...	400	3	1641
DT2__-450...	450	2	1259
DT3__-450...	450	3	2096
DT2__-500...	500	2	1407
DT3__-500...	500	3	2096
DT2__-600...	600	2	1528
DT2__-700...	700	2	1753

Spacing for Multiple Power Controllers

Maintain the minimum distances as shown in the diagram. When multiple power controllers are mounted side-by-side they may be placed as close together as is practical for installation and service.

Power Controller Spacing

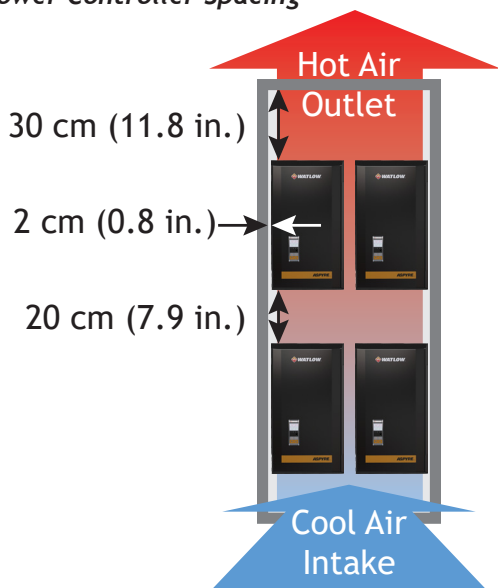

Mounting Dimensions

See the tables for the product dimensions, weight and keyhole mounting slot locations and size.

Power Controller Dimensions and Weight

Model	W	H	D	Weight
DT1...	5.39 in. 137 mm	20.47 in. 520 mm	10.63 in. 270 mm	33.1 lb. 15 kg
DT2...	10.32 in. 262 mm			49.6 lb. 22.5 kg
DT3...				

Dimensions

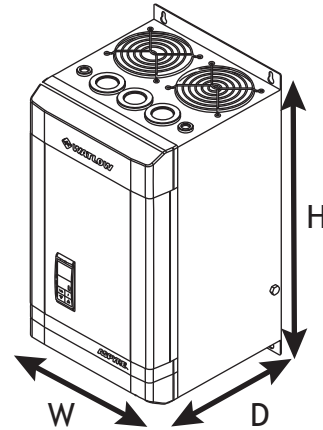

Mounting Slot Locations

Model	A	B
DT1...	3.82 in. 97 mm	19.29 in. 490 mm
DT2...	8.74 in.	19.29 in.
DT3...	222 mm	490 mm

Slot Locations

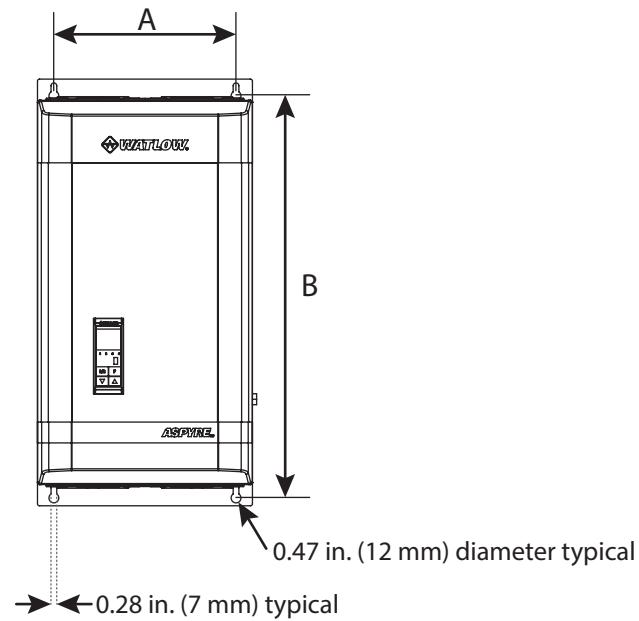



3

Wiring

 **WARNING:** To avoid damage to property and equipment, injury and loss of life, adhere to applicable electrical codes and standard wiring practices when installing and operating this product. Failure to do so could result in damage, injury and death.

 **AVERTISSEMENT!** Pour éviter d'endommager la propriété et l'équipement, les blessures et la perte de vie, respecter les codes électriques en vigueur et les pratiques de câblage standard au moment de l'installation et de l'utilisation de ce produit. Dans le cas contraire, cela peut entraîner la mort, des blessures graves ou des dommages.

 **WARNING:** The installation must be protected by electromagnetic circuit breakers or by fuses. The semiconductor fuses located inside the power controller are classified for UL® as supplementary protection for semiconductor devices. They are not approved for branch circuit protection.

 **AVERTISSEMENT!** L'installation doit être protégée par des disjoncteurs électromagnétiques ou des fusibles. Les fusibles pour semi-conducteurs situés à l'intérieur du régulateur de puissance sont classés UL® comme protection supplémentaire pour les dispositifs pour semi-conducteurs. Ils ne sont pas approuvés pour la protection des circuits de dérivation.

Wiring the ASPYRE Power Controller

This chapter describes how to select, prepare and attach power and signal wires to the power controller.

Good Wiring Practices

Follow good wiring practices to minimize the effects of interference from nearby equipment and the line power on the operation of the power controller:

- Install an appropriately sized RC filter across contactor coils, relays and other inductive loads
- Use shielded twisted-pair cables for input, output and communication signals
- Route control and signal cables away from motors and other sources of electromagnetic interference and not parallel to power cables
- Follow all local regulations applicable to electrical installations

 **NOTE:** Use only copper cables and wires rated for use at 75°C or greater.

 **REMARQUE :** N'utiliser que des câbles et des fils en cuivre pour l'utilisation à 75 °C ou plus.

Wiring Overview Diagrams

The diagrams in this section indicate the locations of the line power, load, earth ground and control signal connections on the power controller.

Connection Locations on Single Phase

Top and Bottom Covers Off

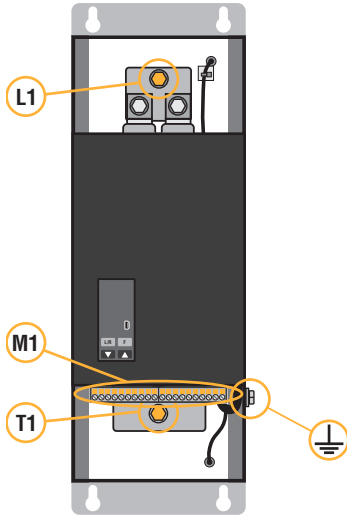

Center Cover Tipped Forward

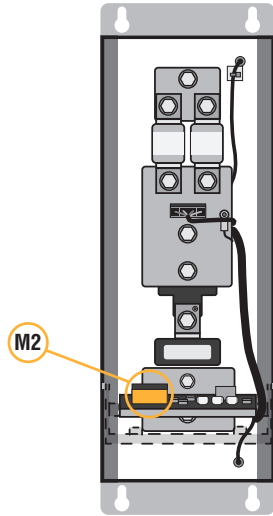

Connection Locations on Three-Phase Models

*Models with 30mm Bus Bar
Top and Bottom Covers Off*

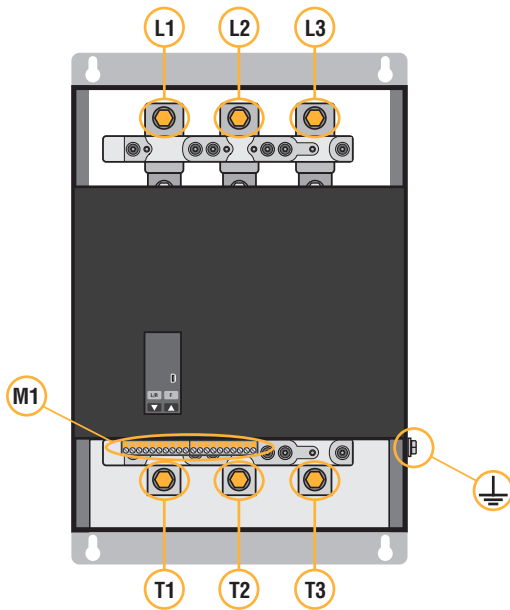

*Models with 60mm Bus Bar
Top and Bottom Covers Off*

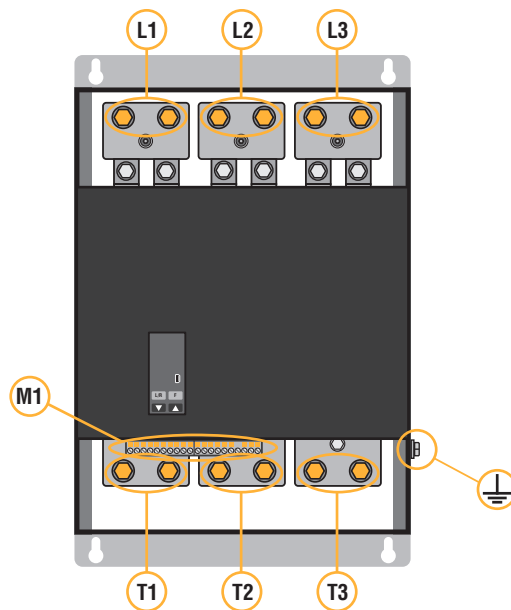

⚠ NOTE! See the tabel below for the bus bar width and number of bolts for your model.

M2 Location on Three-Phase Models

*Top and Bottom Covers Off and
Center Cover Tipped Forward*

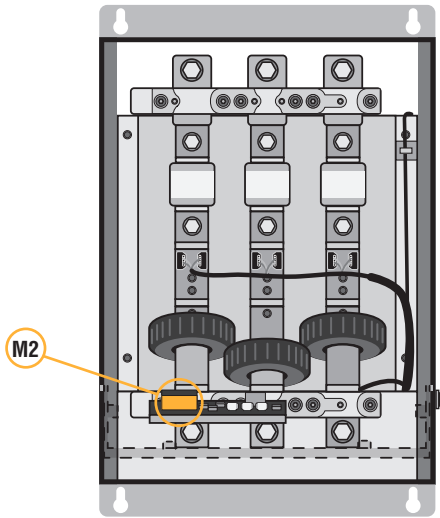

NOTE! Three-leg, 400A model shown. The number of fuses and their placement depends on the model. In all cases the M2 connector is found as indicated.

Wire Selection, Prep and Torque

This section lists the recommended cable and bus bar sizes for line power, load, earth ground and control signal connections. There are also recommendations for insulation stripping and termination torque.

Line Power and Load Cable and Bus Bar Size

Model	Bolt(s)	Bus Bar	Cable Size*
DT__-300...	1 ea. M10	1 ea. 30 x 6 mm	2 ea. 1/0 AWG (70 mm ²) or 1 ea. 350 kcmil (185 mm ²)
DT3_-350...	1 ea. M10	1 ea. 30 x 6 mm	2 ea. 2/0 AWG (70 mm ²) or 1 ea. 500 kcmil (300 mm ²)
DT__-400...	1 ea. M10	1 ea. 30 x 6 mm	2 ea. 3/0 AWG (95 mm ²) or 1 ea. 600 kcmil (400 mm ²)
DT2_-450...	1 ea. M10	1 ea. 30 x 6 mm	2 ea. 4/0 AWG (120 mm ²) or 1 ea. 700 kcmil (400 mm ²)
DT3_-450...	2 ea. M10	1 ea. 60 x 4 mm	2 ea. 4/0 AWG (120 mm ²) or 1 ea. 700 kcmil (400 mm ²)
DT1_-500...	2 ea. M10	1 ea. 60 x 4 mm	2 ea. 250 kcmil (150 mm ²) or 1 ea. 900 kcmil (400 mm ²)
DT2_-500...	1 ea. M10	2 ea. 30 x 6 mm	2 ea. 250 kcmil (150 mm ²) or 1 ea. 900 kcmil (400 mm ²)
DT3_-500...	2 ea. M10	1 ea. 60 x 4 mm	2 ea. 250 kcmil (150 mm ²) or 1 ea. 900 kcmil (400 mm ²)
DT1_-600...	2 ea. M10	1 ea. 60 x 5 mm	2 ea. 350 kcmil (185 mm ²) or 1 ea. 1500 kcmil (800 mm ²)
DT2_-600...	2 ea. M10	1 ea. 60 x 5 mm	2 ea. 350 kcmil (185 mm ²) or 1 ea. 1500 kcmil (800 mm ²)
DT1_-700...	2 ea. M10	1 ea. 60 x 6 mm	2 ea. 500 kcmil (300 mm ²)
DT2_-700...	2 ea. M10	1 ea. 60 x 6 mm	2 ea. 500 kcmil (300 mm ²)

*With UL® Listed (ZMVV) Copper Tube Crimp Lug

NOTE! The line power and load wires for the lower amperage units should enter and exit the package through the provided grommets. The grommets are not pre-cut. Use a knife to cut an appropriately sized slash in the center of each grommet.

Ground Cable Size

Model	Bolt	Wire Size
DT__ _300...	M8	1 AWG (50mm ²)
DT__ _350...		
DT__ _400...		
DT__ _450...		1/0 AWG (70mm ²)
DT__ _500...		
DT__ _600...		
DT__ _700...		

Control and Signal Cable Size

Range: 22 to 14 AWG (0.50 to 1.5mm²)

Recommended: 18 AWG (0.75mm²)

Insulation Stripping and Torque

To insure proper connections, but minimize hazardous exposure of conductors, strip the correct amount of insulation from each cable.

Insulation Stripping

Load & Line Power	Per crimp lug requirements
Ground	Per crimp lug requirements
Control and Signal	0.24 in. (6mm)

Control Signal and Ground Torque

Control & Signal	4 in.-lb. (0.11 Nm)
Ground	221 in.-lb. (25.0 Nm)

Line Power and Load Torque

Model	Wire Termination	Proper Torque
DT__ _-300...	UL® Listed (ZMVV) Copper Tube Crimp Lug or bus bar	505 in.-lb. (57 Nm)
DT__ _-350...		
DT__ _-400...		
DT__ _-450...		
DT__ _-500...		
DT__ _-600...		
DT__ _-700...		

Removing the Covers

 **WARNING:** To prevent injury and loss of life, shut off power and ensure it cannot be restored while performing work with the covers open or removed.

 **AVERTISSEMENT :** Pour éviter les blessures et les pertes de vie, couper l'alimentation électrique et s'assurer qu'elle ne peut être restaurée pendant l'exécution du travail avec les couvercles ouverts ou enlevés.

To remove the top cover (line power) or bottom cover (load connections):

1. Loosen and remove the fasteners (1 ea. single-phase, 2 ea. three-phase).
2. Tilt the cover toward you and remove it.

To access the M2 connector:

- After removing the top and bottom covers, tilt the center cover forward.



Connecting Control Signals

This section shows how to connect control signals to the M1 and M2 terminal strips.

M1 Terminal Connections

M1	Function	Description
1	Alarm output	NO (normally open contact)
2		C (common)
3		NC (normally closed contact)
4	Analog input 2+	Alternate set point, external feedback or current limit (DT1 and DT3)
5	Digital input 2	See “Configurable Digital Inputs (Digital Input 1 and Digital Input 2)” on page 27
6	Digital input 1	
7	Port 1 Modbus® RTU RS-485*	Connect to B+ on USB-to-485 adapter
8		Connect to A- on USB-to-485 adapter
9	+10VDC power supply	For dry contact digital inputs or potentiometers for analog inputs
10	Analog common 10 and 24V	For analog inputs, retransmit and RS-485 common
11	Analog common 10 and 24V	
12	Analog input 1+	Set point signal input
13	Digital input common	Reference to analog common, if necessary
14	Not Used	
15	Power input for fan	+ For DC fans, line or neutral for AC fans
16		- For DC fans, line or neutral for AC fans
17	Not used	
18	Auxiliary power input	Line 1
19	Not used	
20	Auxiliary power input	Line 2 or neutral on single phase units

M2 Terminal Connections

M2	Function
1	+24VDC supplemental power for applications that use both analog retransmit and the second communication port (other than Modbus® RTU)
2	Unused
3	Retransmit output+
4	Analog common 10 and 24V for 24VDC input, retransmit output and RS-485 common

Secondary Modbus® RTU Terminal Connections*

	Function	Description
A+	Port 2 Modbus® RTU RS-485	Connect to B+ on USB-to-485 adapter
B-		Connect to A- on USB-to-485 adapter

*Connect 485 signal here only on units with second Modbus® RTU 485 communications port option. Connecting signal here on units with other wired communications options will interfere with the operation of that option.

Set Point (Analog Input 1)

To control the power to the load with a device such as a temperature controller, connect the control signal to analog input 1.

This input accepts current (0 to 20mADC, 4 to 20mADC), voltage (0 to 10VDC) and potentiometer (0 to 10,000Ω) signals. Configure the power controller to recognize the signal on the hardware menu; see “Analog In 1 [Signal Type]” on page 53.

Analog Input 1 Wiring on M1 Terminals

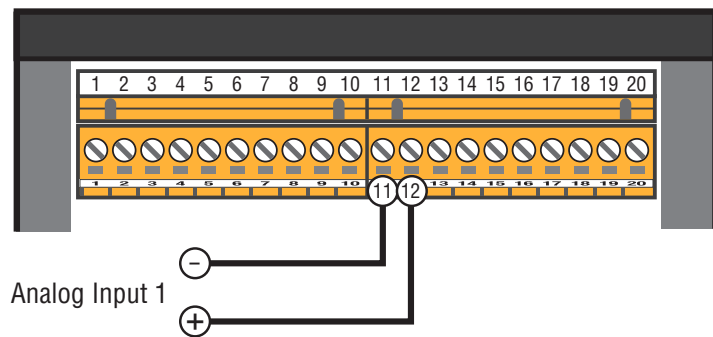

Set Point, Feedback or Current Limit (Analog Input 2)

What this input does is user-configurable. Connect an analog signal that indicates:

- An alternate set point signal
- Measured power, voltage or current for use as feedback
- In models with the current limit option: the maximum current to the load (current limit set point)

This input accepts current (0 to 20mADC, 4 to 20mADC), voltage (0 to 10VDC) and potentiometer (0 to 10,000Ω) signals. Configure the power controller to recognize the signal and how the power controller uses it on the hardware menu; see “Analog In 2 [Signal Type]” on page 54 and “Analog In 2 Function” on page 54.

Analog Input 2 Wiring on M1 Terminals

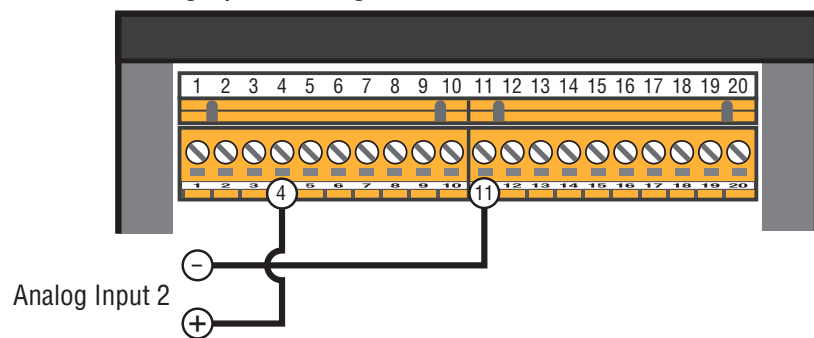

Configurable Digital Inputs (Digital Input 1 and Digital Input 2)

What these inputs do is user-configurable. Connect digital signals to:

- Enable the power controller to output power to the load
- Change the feedback to voltage
- Change whether the local or remote set point is used
- Change the firing type to phase angle

Configure how the power controller uses these signals on the hardware menu; see “Digital In 1 Function” on page 56 and “Digital In 2 Function” on page 57.

Digital Input Wiring on M1 Terminals

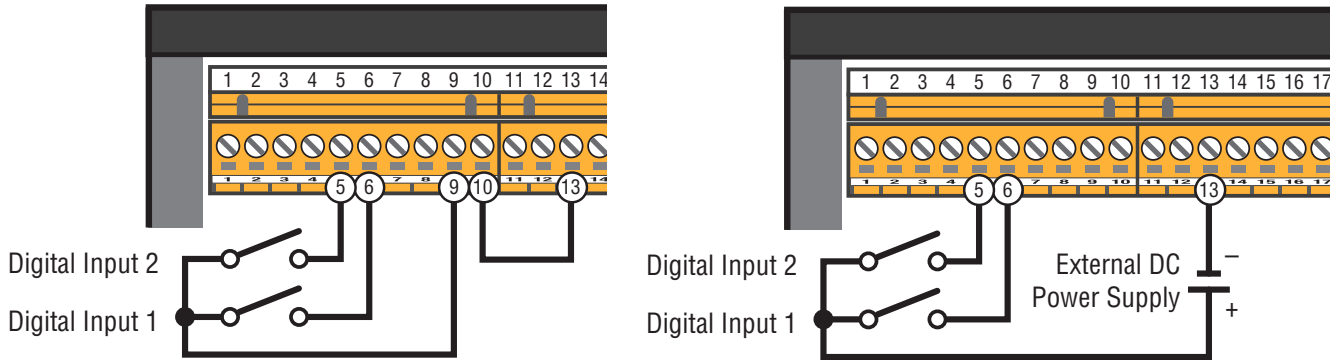

NOTE! If you use the +10VDC power supply to provide the input signal, connect the 10VDC common (M1 terminal 10) to the digital input common (M1 terminal 13).

Alarm Outputs

Connect to the relay contacts so that alarms in the power controller can be detected or enunciated by external devices. Configure which alarms cause the relay to energize with the hardware menu; see “Alarm Function” on page 53.

Alarm Wiring on M1 Terminals

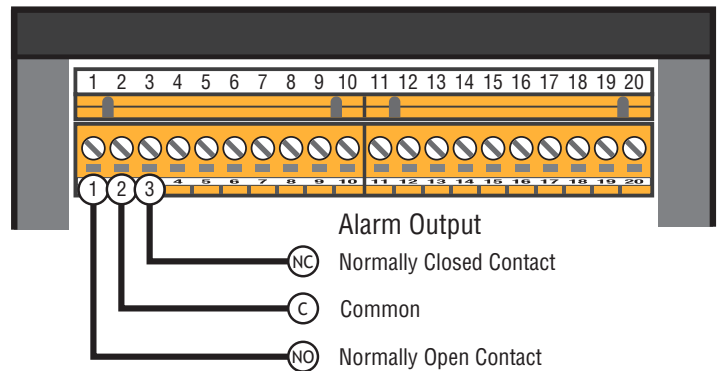

Retransmit Option

Connect the analog output to an external device so it can monitor or record set point, current, voltage, or actual power.

Which data is retransmitted and the scaling of the output are user-configurable on the hardware menu; see “Retransmit (Models with Retransmit)” on page 65, “Retransmit Type (Models with Retransmit)” on page 66 and “Retransmit Scale (Models with Retransmit)” on page 66.

If using the retransmit feature and any of the Ethernet protocols or Profibus, connect an external power to the supplemental 24VDC input.

Retransmit Wiring on M2 Terminals

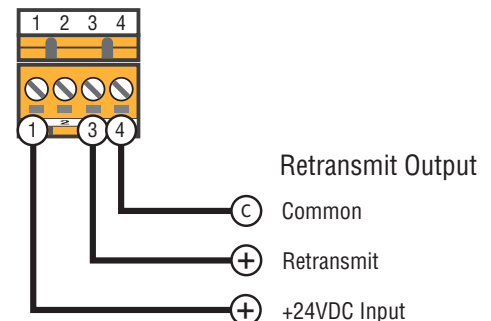

Communication Connections

All models include at least one RS-485 communication port. Some models include a second communication port. Connect these ports to allow other equipment to monitor, operate or configure the power controller. The communication protocols have adjustable software settings on the *Communication* menu see the “Menu Listing” on page 37. Connect RS-485 communication common to any analog common terminal.

RS-485, Modbus® RTU Wiring on M1 Terminals

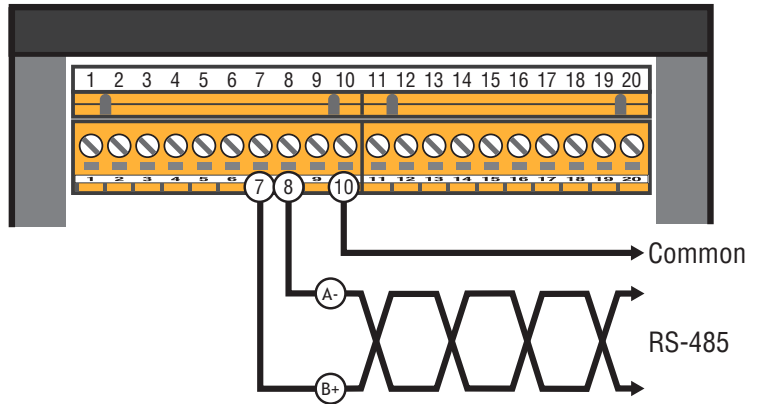

Accessing the Optional Second Communication Port

The second communication port, if present is located on a daughter card mounted on the back of the main electronics board. Tip the center cover forward and down to access the port.

Communication Options

Model	Communication Option	Connector Location on Daughter Card
DT_ _ _ _ _ 0 _ _ _	No additional port	N/A
DT_ _ _ _ _ 1 _ _ _	Modbus® TCP (Ethernet)	RJ-45 on right side
DT_ _ _ _ _ 2 _ _ _	Modbus® RTU (2nd RS485 port)	2-pin connector on left side*
DT_ _ _ _ _ 3 _ _ _	Profibus DP	DB9 connector on right side
DT_ _ _ _ _ 4 _ _ _	Profinet	RJ-45 on right side
DT_ _ _ _ _ 5 _ _ _	EtherNet/IP™	RJ-45

*Connect 485 signal here only on units with second Modbus® RTU 485 communications port option. Connecting signal here on units with other wired communication options will interfere with the operation of that option. Connect RS-485 communication common to any analog common terminal.

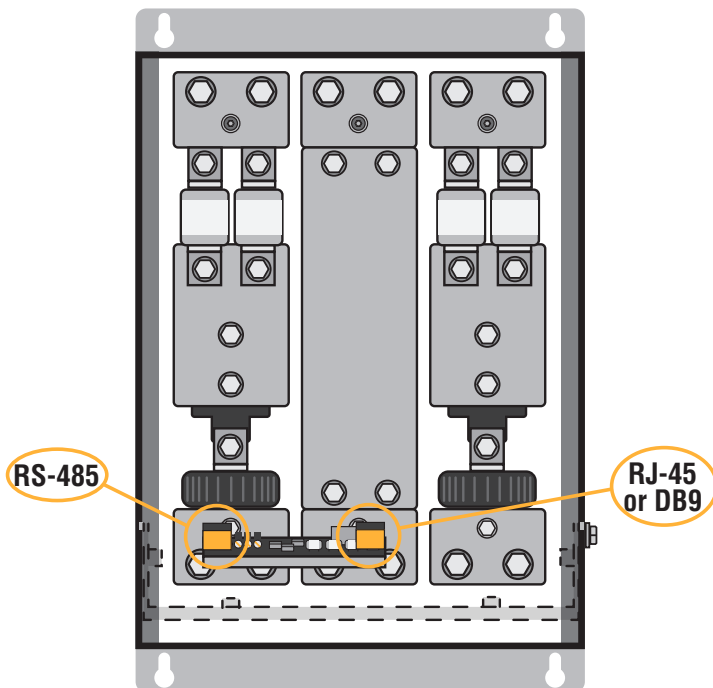

Powering the Cooling Fans

Connect power of the appropriate voltage for the cooling fans. Install fuses on each hot leg (not required for single-phase neutral). Use 2A class CC fuses rated for 600VAC similar to Cooper Bussman® LP-CC Series. Supply power for fans: 34W (single-phase models), 68W (three-phase models).

Cooling Fan Voltage

DT	-	-0	No Fan
DT	-	-1	120VAC
DT	-	-2	240VAC
DT	-	-3	24VDC

Fan Power

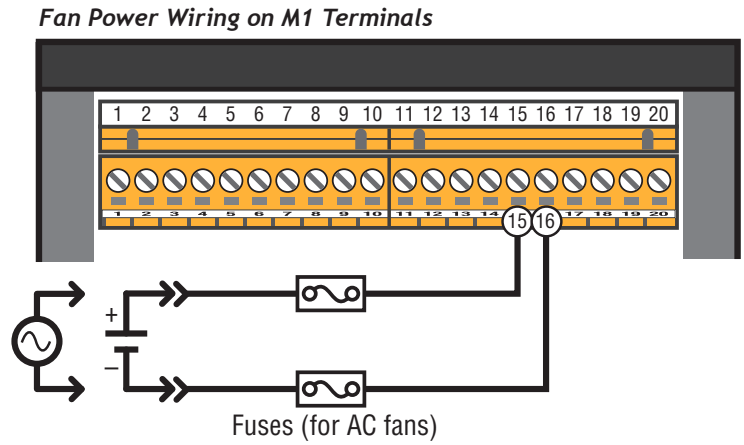

Connecting the Auxiliary Power

The auxiliary power input supplies the controller’s electronics. The voltage supplied at M1 terminal 18 must be synchronized with the phase that is connected to the L1 line power terminal. The auxiliary voltage is indicated on the product identification label and encoded in the part number as the *nominal voltage* (character 9).

Install fuses on each hot leg (not required for single-phase neutral). Use 2A class CC fuses rated for 600VAC similar to Cooper Bussman® LP-CC Series.

Auxiliary Power Input on M1 Terminals

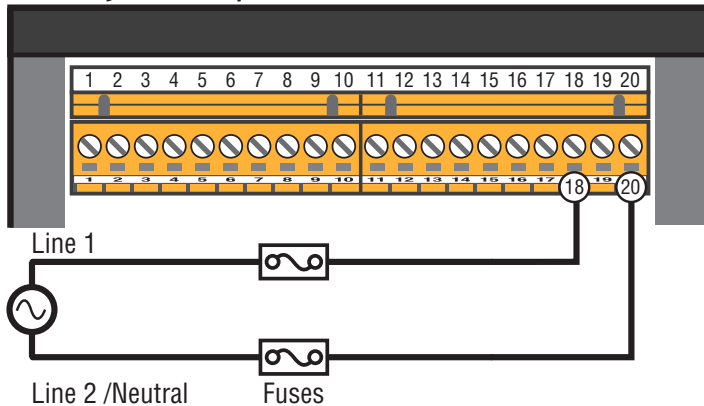

Wiring the Line Power and Load

Line Power Connection Locations

The following illustrations indicate how to connect line power and loads.

Single-Phase Line Power and Load Wiring

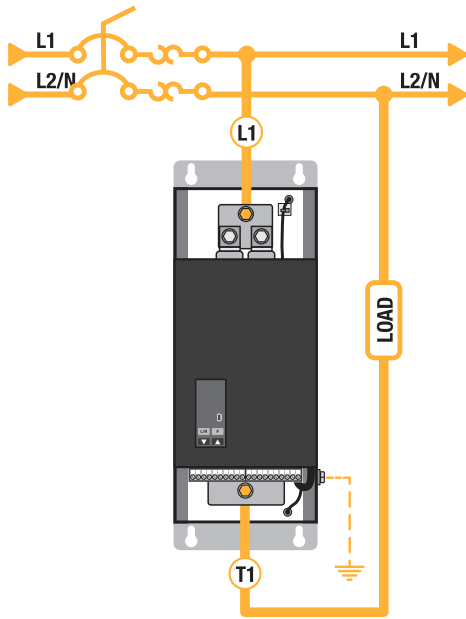

Three-Phase Line Power and Load Wiring

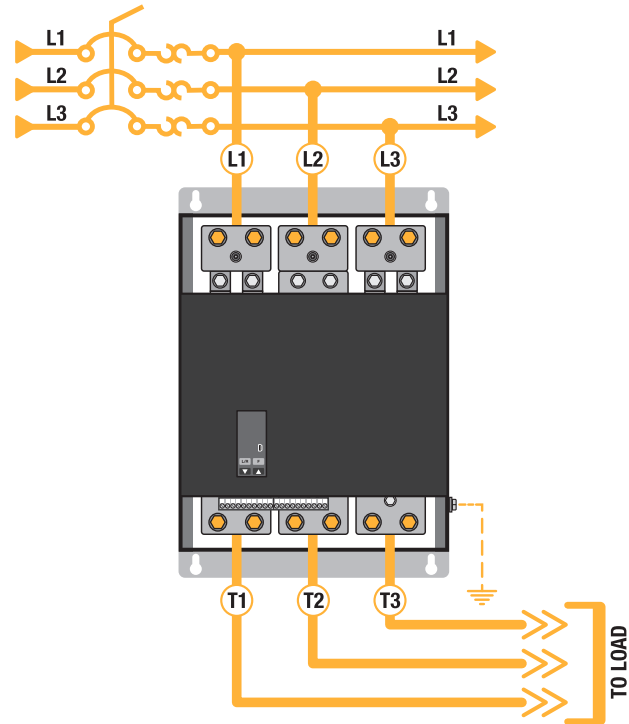

Three-Phase, Two-Leg Load Wiring Configurations

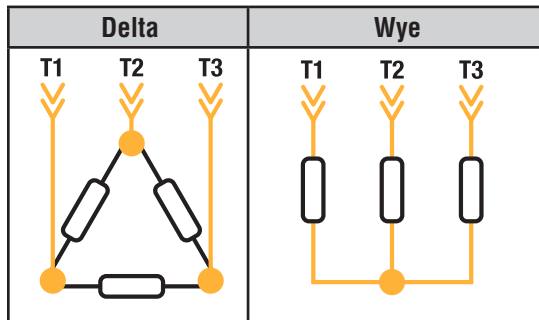

Three-Phase, Three-Leg Load Wiring Configurations

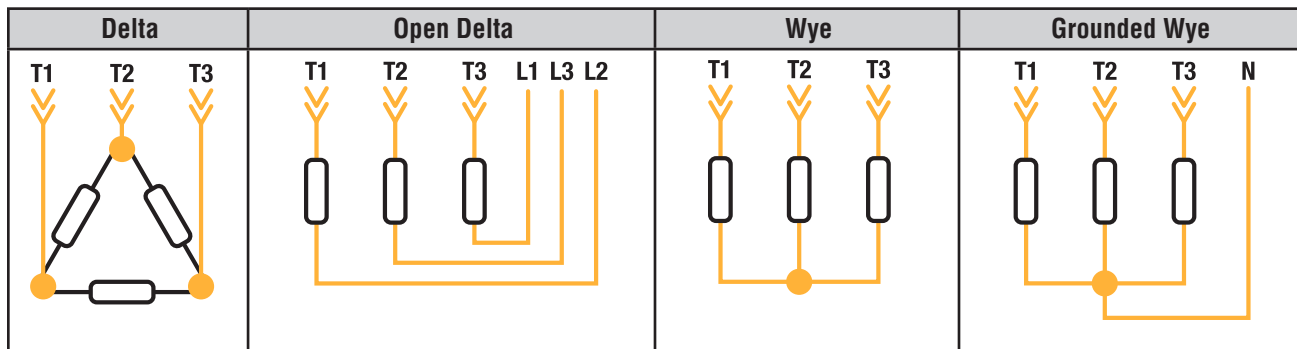

4

Initial Setup

This chapter provides the information necessary to begin using your ASPYRE power controller.

The procedures below call for setting and verifying parameter settings. These parameters can be set via the control panel or using the *ASPYRE Configurator* software. To learn more about how to use the control panel to access and set parameters on the menus; see “Menu Navigation” on page 36.

Using the ASPYRE Configurator Software

The power controller can be set up and monitored via the menus using the on-board keypad and display or using a computer running the ASPYRE Configurator software. The ASPYRE Configurator software is available on the Watlow website.

To use the software:

1. Download and run the ASPYRE Configurator software installation file and follow the on-screen instructions.
2. Connect a USB cable (Watlow p/n 0219-0480-0000) between a USB host port on the computer and the micro USB port on the front of the ASPYRE power controller.
3. Wait for the communications port installation to complete.
4. Launch the ASPYRE Configurator software
5. From the **Setting** menu, choose **Serial Port**.
6. Choose the communications port and click **OK**.
7. For a single-phase model select **ASPYRE** or for a 2-leg or 3-leg model, select **ASPYRE 3PH**.
8. Click **Upload from unit**.
9. Click **Read**.
10. In the **Selection** list under power controller click the menu to access.

ASPYRE Configurator Software



Configuring the ASPYRE Power Controller

The ASPYRE power controller includes many advanced features. You can learn more about these in the *Features* chapter of the manual. In order to get the optimum performance in your application, be sure to verify or adjust these settings before beginning operation.

Initial setup:

1. Nominal current and voltage
2. Firing type
3. Feedback type
4. Input for power request / set point
5. Enable input, if used
6. Current limit (DT1 and DT3 models), if used

Set Nominal Current and Voltage

In order for the power controller to function correctly, set the nominal line voltage and load current. To calculate the nominal load current see “Digits 6, 7 and 8, Amperage” on page 13. Otherwise it can be determined empirically after completing the installation and other setup steps by applying 100% power and measuring the resulting current.

	On this menu...	set this parameter...	to the...
1	Setup	Nominal V	nominal line voltage (RMS)
2	Setup	Nominal I	nominal current (RMS) in each leg of the load at 100% power

Set the Firing Type

Choose the firing type in order to optimize the performance of the load.

On this menu...	set this parameter...	to the...
Adv Setup	Firing	type of power switching appropriate for your load

Also on the *Adv Setup* menu set the parameters that adjust the behavior of the firing type you chose.

For...	set this parameter...	to the...
Phase Angle Soft Start	Soft Start	amount of time for the output to ramp to the set point
Burst Fire Start Ramp	Start Ramp	number of half cycles over which each burst should ramp
Burst Fire Burst Fire Start Ramp Burst Fire Delay Trigger BF Strt Rmp Delay Trigger	Min Cycles	fewest number of cycles the output should be on or off
Burst Fire Delay Trigger	Delay	firing delay from zero cross in degrees
BF Strt Rmp Delay Trigger	Half Cycles to Delay	number of half-cycles to which to apply the delayed firing
Zero Crossing	Cycle Time	duration of each on-off cycle
Half Cycle Safety Ramp	Safety Ramp Duration	amount of time for the output to ramp to the set point
	Safety Ramp Off Time	minimum amount of off-time before ramping is needed

Set the Feedback

Choose the variable to use for feedback to optimize the performance of the application.

On this menu...	set this parameter...	to the...
Adv Setup	Feedback	type of measured feedback appropriate for your application

Configure the Input for Power Demand / Set Point

The signal to analog input 1 indicates the desired percent of full output the power control should deliver to the load.

Configure the power request / set point signal:

On this menu...	set this parameter...	to the type of signal and range...
Hardware	Analog In 1	0-10 V / 10k pot (0 to 10 VDC or potentiometer)
		4-20mA (4 to 20 mADC)
		0-20mA (0 to 20 mADC)

⚠ NOTE! This procedure assumes the analog input signal wiring, if used has been connected and that the signal can be set to various values as needed to perform the procedure. See “Set Point” on page 67.

Configure the Enable Input

By default digital input 1 is used to enable the power controller.

To verify that digital input 1 is configured to enable the power controller:

- On the *Hardware* menu verify that *Digital In 1 Function* is set to *Enable*.

⚠NOTE! If the power controller is used to switch power on and off simply following an on-off or time proportioned signal, that signal can be connected to the enable input and the set point can be set to 100%.

Configure the Current Limit

For models with this option the current limit feature prevents the current from exceeding the user-set current limit. As the current approaches the limit, the power controller decreases its output to avoid exceeding the current limit. The current limit set point can be set with the *I Limit* parameter or by an analog input.

⚡CAUTION: This procedure must be performed only by qualified persons.

⚡CAUTION: This procedure requires turning on full power to the load. This should only be performed once the installation is complete and when it is safe to provide full power.

⚠NOTE! this procedure assumes the analog input signal wiring, if used has been connected and that the signal can be set to various values as needed to perform the procedure. See “Set Point, Feedback or Current Limit (Analog Input 2)” on page 26.

⚡ATTENTION : Cette procédure ne doit être effectuée que par le personnel qualifié.

⚡ATTENTION : Cette procédure nécessite la mise sous tension totale de la charge. Cela ne doit être effectué qu’une fois l’installation terminée et lorsque la puissance maximale peut être fournie en toute sécurité.

To limit the current using the parameter setting:

1. On the *Hardware* menu set *I Limit Local / Remote* to *Local*.
2. On the *Operator* menu set *I Limit* to 0%.
3. Enable the power controller and set the power demand set point to 100%.
4. Gradually increase the current limit set point until the RMS current is at the maximum desired value.
5. Disable the power controller.

To limit the current using the signal to analog input 2:

1. On the *Hardware* menu set *Analog In 2* for the type of signal and range:

0 to 10 VDC or 10k potentiometer	0-10 V / 10k
4 to 20 mADC	4-20mA
0 to 20 mADC	0-20mA

2. On the *Hardware* menu set the *Analog In 2 Function* to *I Limit*.
3. On the *Hardware* menu set the *I Limit Local / Remote* to *Analog In 2*.
4. Set the signal to the analog input to the minimum value (typically 0 V).
5. Enable the power controller and set the power demand / set point to 100%.
6. Gradually increase the signal to the analog input until the RMS current is at the maximum desired value.
7. Disable the power controller.

5

Operation

This chapter describes how to operate the controller using its control panel interface, how to access and navigate the menus and how to interpret the indicators and alarm messages.

Control Panel

The control panel is located on the front of the power controller. The display indicates the alarms, input and output signals, and by navigating the menus with the keypad, provides access to the configuration parameters.



Output Current RMS



Output Voltage (RMS)



Output Power (Average)



Alarms

On the home page the keys are used as follows:

Press...	to...	
F	Function	Scroll through the parameters on the home page
L/R	Local / Remote	Switch between local and remote set point for power demand
	Up	Increment power demand set point when set to local
	Down	Decrement power demand set point when set to local
L/R + F		Press and hold for about two seconds to access the menus

To view the status parameters:

- Press function F once to advance from one parameter to the next

To set the set point locally:

1. Press local / remote L/R (Note: indicator 1 flashes steadily when set point is set locally.)
2. Use down and/or up to set the local set point.

Menu Navigation

The menus are accessible using the control panel keypad and display.

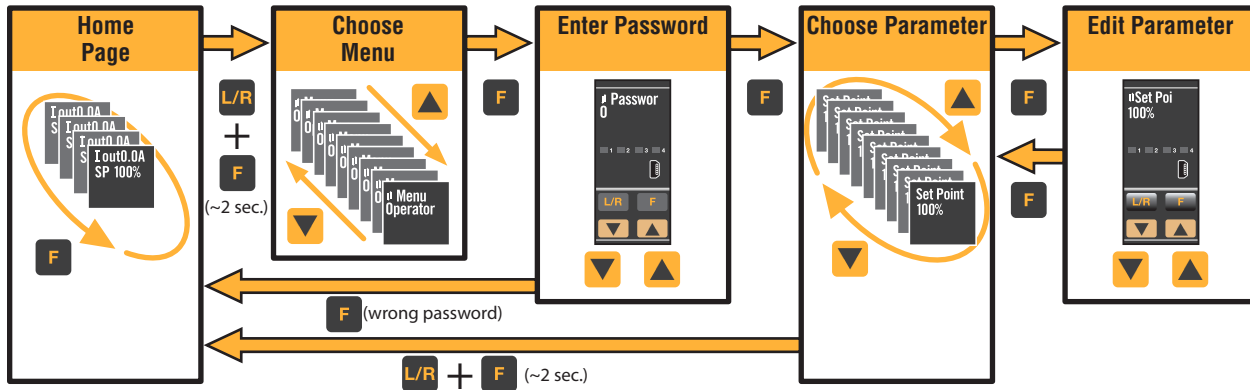

To access a menu and edit a setting:

1. Press and hold local / remote and function together **L/R + F** until the upper display flashes Menu.
2. Press up **▲** to choose the menu. (Press down **▼** if you overshoot the menu you want.)
3. Press function **F** to advance to the password prompt.
4. Use up **▲** and/or down **▼** to set the password (see the table).
5. Press function **F** to enter the password and advance to the first parameter on the menu.
6. Press up **▲** to advance to the next parameter and repeat to reach the desired parameter.
7. Press function **F** to start editing the parameter. The parameter name flashes in the upper display.
8. Use up **▲** and/or down **▼** to change the parameter setting.
9. Press function **F** to stop editing the parameter. The parameter name stops flashing.
10. Press and hold local / remote and function together **L/R + F** for about two seconds to exit the menus.

Menu	Password	Parameters Used To...
Operator	0	View measured values and basic settings including current, voltage and set point
Setup	2	Configure the power controller for the load
Adv Setup	10	Configure power switching, closed-loop control of power and adjustable settings for data logging and heater bakeout
Hardware	5	Configure the functions of the analog and digital inputs and outputs, and the re-transmission parameters
Comm	3	Configure communication parameters
Monitor	0	View the states of digital inputs, values of analog inputs and information about the power controller such as serial number and software version

Menu Listing

The table below lists the parameters found on each menu. See “Parameter Reference” starting on page 53 for descriptions and the other details of each parameter.

Operator	Setup	Advanced Setup	Hardware	Communication	Monitor
Set Point	Out Scale	Firing	Analog In 1	Port 1 Baud	Digital In 1
V Output	I Limit ²	Min Cycles	Analog In 2	Port 1 Address	Digital In 2
I Output	Nominal V	Soft Start	Analog In 2 Function	Port 2 Baud	Enable
Leg 1 I Output ¹	Nominal I	Safety Ramp Off Time	Digital In 1 Function	Port 2 Access	Set Point Source
Leg 2 I Output ¹	Soft Start	Safety Ramp Duration	Digital In 2 Function	Watchdog	Analog In 1
Leg 3 I Output ¹	Remote SP	Start Ramp	Alarm Function	Watchdog Reset Time	Analog In 2
Power		Half Cycles to Delay ²	I Limit Local / Remote ²	Wi-Fi Address ³	Version
V Input		Delay	Retransmit ³	Ethernet Address ³	Release
Frequency		Cycle Time	Retransmit Scale ³	Ethernet Subnet ³	Unit Type
Power Factor		Feedback	Retransmit Type ³	Ethernet Gateway ³	Max Voltage
Load Ω		Prop Band Power	Startup Display	Host Name	Max Current
I Limit ²		Integral Power		Port 2 Address	Aux Voltage
Out Scale		Prop Band Current ²		Port 2	Serial Number
Nominal V		Integral Current ²		Wi-Fi ³	SCR Temperature
Nominal I		Htr Break Sensitivity			MM/DD/YY ³
		Htr Break Delay			HH:MM:SS ³
		Logging			kW Real Time
		Logging Interval			kW Total
		Heater Bakeout ²			kVA Real Time
		Bakeout Ramp Time ²			Thermal Alarm Counter
		Bakeout Current ²			
		Bakeout Off Time ²			
		Neutral Connected ¹			

Shaded items are read only.

¹DT2 and DT3 models

²DT1 and DT3 models with the current limit option

³Models with corresponding options (retransmit, Ethernet, Wi-Fi and/or real-time clock)

Indicators (LEDs)

The four indicators on the control panel show the general state of the power controller.

	1	Local/Remote	Flashing	Power output set locally or via communications
			Off	Power output set remotely (via analog input)
	2	Enable	On	Output enabled
			Off	Output disabled
3	Communication	Flashing	Active communications	
4	Alarm	On	Active alarm	
		Off	No alarm	

Alarms and Messages

The power controller display indicates certain modes of operation and alarms by flashing a message on the top display.

Alarm or Message	DT1	DT2	DT3	Description
Aux High	X	X	X	Aux voltage too high
Aux Line Loss	X	X	X	Auxiliary power is not detected
Aux Low	X	X	X	Aux voltage too low
Bakeout	X		X	Heater bakeout function is active
Heater Break	X	X	X	Heater break alarm
I Limit	X		X	Output reduced by current limit feature
PH Loss		X	X	One or more phases of the line power are disconnected
SD Card Error	X	X	X	SD card error
SCR Short	X	X	X	Shorted SCR causing output to be on continuously
SCR Over Temp	X	X	X	Thermal switch over temperature
Unbalance Load		X	X	One or more legs of the load are open
Watchdog	X	X	X	Communication watchdog error

6

Using ASPYRE Configurator

This chapter explains how to use the ASPYRE Configurator software as an alternative to using the power controller's keypad and display for viewing and setting parameters as well as the advanced features not available via the power controller's onboard user interface.

Overview

This section describes the scope and intent of the ASPYRE Configurator software.

Typical Uses

The software may be used during commissioning to set and make a record of settings that determine how the power controller operates and performs; to copy or clone the setup of one power controller to another; on a day-to-day basis to monitor operation and power usage; if necessary, to examine performance in more detail to determine if any corrective actions are needed; or to restore the setup of the power controller.

Communicating with Power Controllers

ASPYRE Configurator software can communicate with ASPYRE power controllers via USB or RS-485. When initially commissioning the power controller it is convenient to connect a computer to the power controller via the USB port located below the control panel's display. The power controller's electronics are powered by the computer via the USB connection when the auxiliary line power is turned off. This makes it possible to examine and configure the power controller's settings prior to applying power to the panel.

USB is designed to connect consumer electronics and peripheral devices such as cameras and keyboards to computers in home and office environments; it is not an industrial communications protocol. To continue communicating once the panel door is closed and line power is on, connect the computer to the power controller via the RS-485 communications port. See "Communication Connections" on page 28.

Recipes

A *recipe* is a computer file which contains a setting for each user adjustable parameter in a power controller. A recipe can be used to configure a power controller for a particular application or job. A recipe can be used to copy the settings of one power controller to another. A recipe can be created by *uploading* the settings from a power controller to the ASPYRE Configurator software and saving it as a file on the computer. A power controller can be configured by *downloading* a saved recipe from the ASPYRE Configurator software to the power controller.

How To

This section provides step-by-step procedures for common tasks.

Communicate For the First Time

These procedures are for installing the software and establishing communications for the first time.

To install ASPYRE Configurator:

1. Locate the installer:
 - On www.watlow.com linked to the ASPYRE power controller product page. Download the installer to your computer
 - On the Controls Tools DVD ROM disk.

2. Double-click the installer program.
3. Follow the on-screen instructions to complete the installation.

To communicate with a power controller:

1. For the direct USB connection:
 - Connect the USB cable (Watlow p/n 0219-0480-0000) between the computer and the micro USB connector between the display and keypad on the ASPYRE power controller's control panel.
 - Wait for the USB driver to install, if necessary.
2. For an RS-485 connection:
 - Connect the computer to the ASPYRE power controller. See "Communication Connections" on page 28. For most computers a USB-to-485 converter is required (Watlow p/n 0847-0326-0000).
3. Launch the ASPYRE Configurator software.
4. Select:
 - **ASPYRE** to communicate with a single-phase power controller
 - **ASPYRE 3PH** to communicate with a three-phase power controller (two or three switched legs)
5. From the **Setting** menu, choose **Serial Port**.
6. For **Port**, select the COM port that is connected to the power controller (see the note below).
7. To verify communications, click **Test**.
8. Click **OK**.

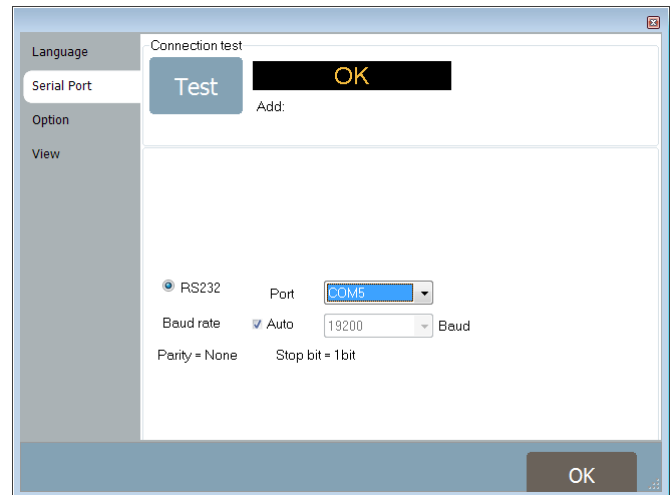
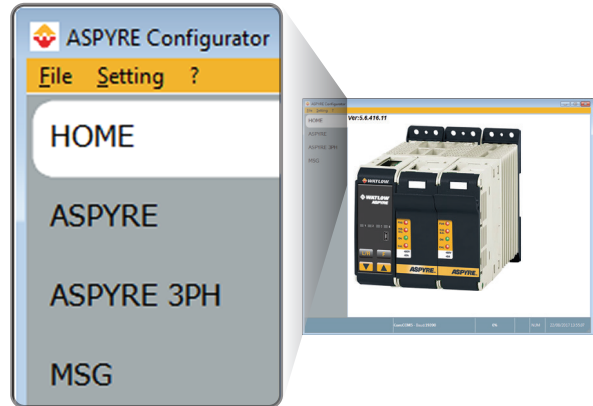

NOTE! There are several ways to determine which port is connected to the power controller. You can look in the Windows® Device Manager under Ports (COM & LPT) for the COM port named "LPC USB VCOM Port (COMx)" where x is the port number. You can also disconnect the USB cable from the computer, run ASPYRE Configurator and note the ports available in the list on the Serial Port dialog, then close ASPYRE Configurator, reconnect the USB cable and run the program again; the port that did not appear previously is the correct one.

Using ASPYRE Configurator

These procedures are for using the software once communication has been set up. They assume the software has been installed and the COM port and model type (ASPYRE or ASPYRE 3PH) have already been selected.

To view or save a power controller's settings using the Simple view:

1. Click **Simple**, if not already on the simple view.
2. Click **Upload from unit**.
3. Set the address, if necessary.
4. Click **READ**.
5. Wait for the software to read the parameter settings.
6. Click **OK**.

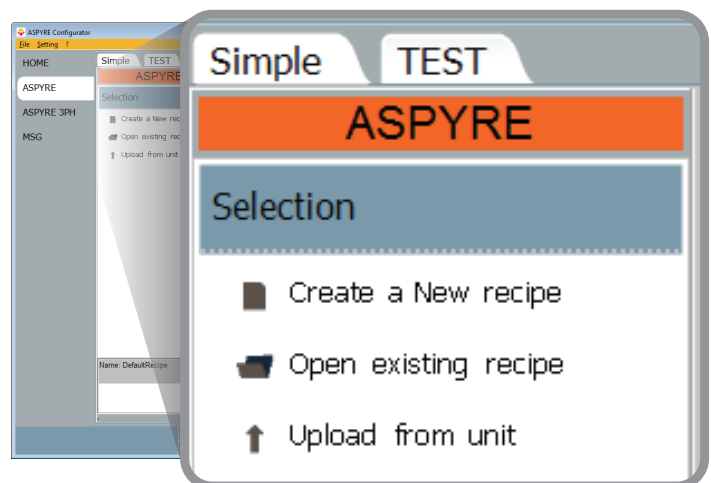

7. If desired, to save the settings in a recipe file:

- Click **Save**.
- Name the recipe.
- Click **Save**.

NOTE! In the simple view, the parameter values are only read from the power controller when the user uploads the settings. Changes to parameter values are only set in the controller when the user downloads the settings.

To edit a setting in a recipe:

1. Click **Simple**, if not already on the simple view.
2. Click **Open** existing recipe.
3. Locate and select the recipe file and click **Open**.
4. Click **OK**.
5. Click the menu with the setting you want to change (**Setup**, **Advanced setup**, **Hardware** or **Communications**).
6. Select the value you want to change.
7. Edit the value with the increment and decrement buttons in the field or type the new value and press the Enter key.
8. Repeat steps 5 to 7 for all the changes you want to make.
9. To save the settings in a recipe file:
 - Click **Save**.
 - Name the recipe.
 - Click **Save**.

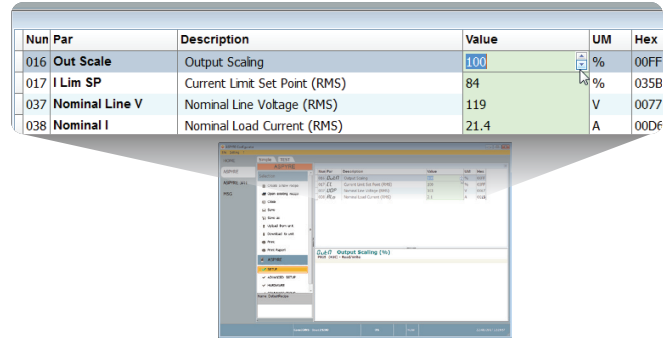
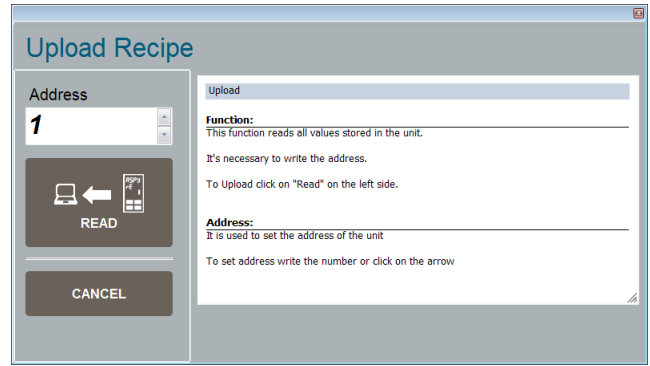

To download a recipe file into a power controller:

1. Click **Simple**, if not already on the Simple view.
2. Click **Open** existing recipe.
3. Locate and select the recipe file and click **Open**.
4. Click **OK**.
5. Click **Download to unit**.
6. Set the address, if necessary.
7. Click **SEND**.
8. Wait for the software to write the parameter settings.
9. Click **OK**.

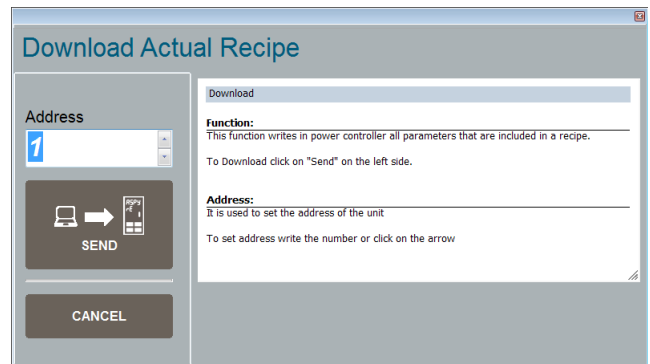

To monitor a power controller with the Test view:

1. Click **Test**, if not already on the test view.
2. Click **Connect**.

To log in on the test view to change the digital input and analog input functions:

1. Click the **Access Level** value (zero when logged out).
2. Type the password: **1111**.
3. Click **OK**.

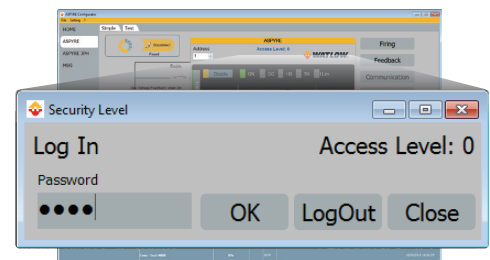

To log out the test view:

1. Click the **Access Level** value.
2. Click **Log out**.
3. Click **OK**.

To view data on the scope:

1. Click **Test**, if not already on the test view.
2. Click **Connect**.
3. Click **Load Analyzer**.
4. For each of up to three channels (Ch 1 to Ch 3):
 - With **PV1** choose the value to monitor
 - Select **Show**.
 - Click the color swatch to change the color
 - Click the button to turn the channel on.

To reset the power totals:

1. Click **Test**, if not already on the test view.
2. Click **Connect**.
3. Click **Reset Totals**.
4. Click **Yes**.

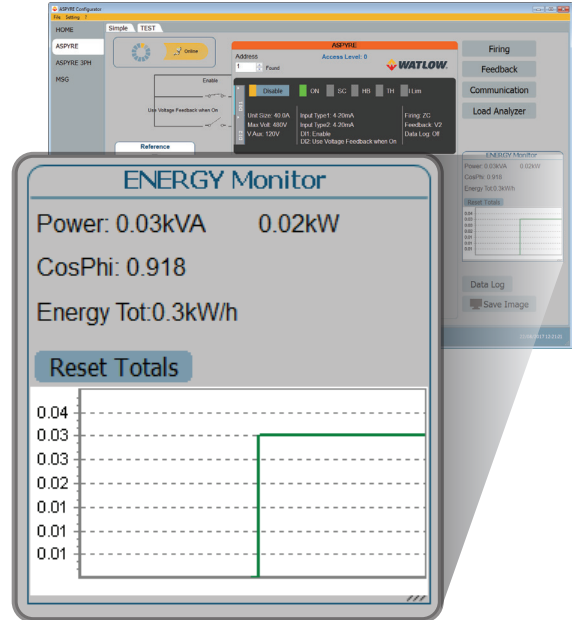

Setting Up and Using Data Logging

To set up data logging:

1. Click **Test**, if not already on the test view.
2. Click **Connect**.
3. Click **Data Log**.
4. In the **Data Log** window ensure the slider is set to **Log Enabled**.
5. Click **Set Time**.
6. Set the date and time and close the date/time window.
7. Set **Log Time** to the number of seconds between records.
8. Click **Connect**.
9. Click **Config**.
10. For up to ten parameters to log:
 - Click **+** to add a parameter to the list
 - In a row in the list either:
 - Type a parameter's Modbus® address in the **Par** field
 - OR
 - Select the parameter from the drop down list in the **Name** field
11. Click **Save** to send the parameter list to the controller
12. Click **OK** when prompted that the download is complete.
13. Click **Close**.

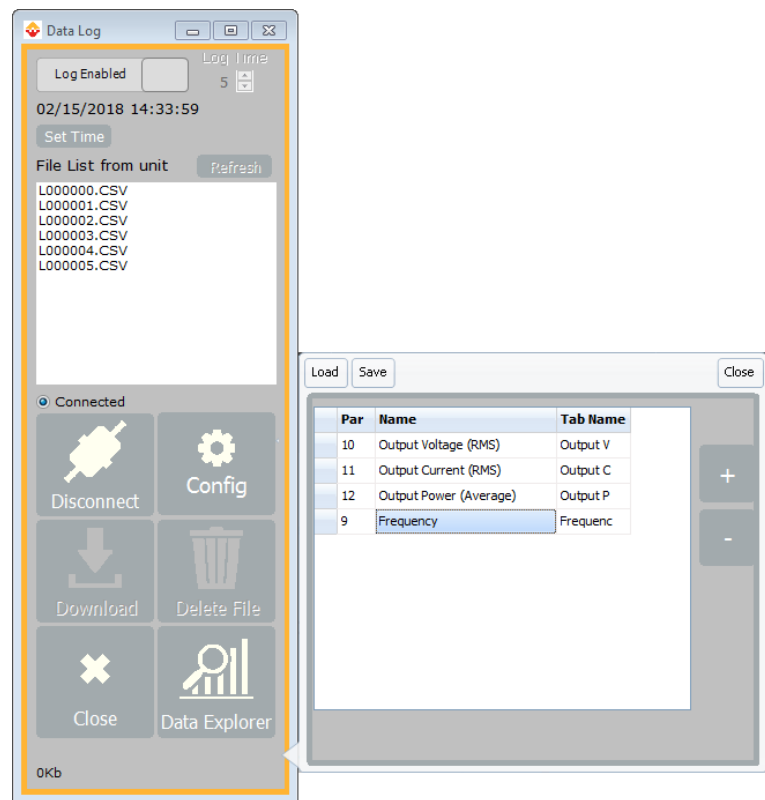

14. Click **Disconnect**.
15. Close the **Data Log** window.

To retrieve a data log file from the power controller:

1. Click **Test**, if not already on the test view.
2. Click **Connect**.
3. Click **Data Log**.
4. Click **Connect**.
5. Select a file from the list.
6. Click **Download**.
7. Select a location and click **Save**.
8. Wait for the file to download. The progress is indicated at the bottom of the **Data Log** window.
9. Click **OK** when prompted that the download is complete.
10. To delete the log file from the controller memory, if desired, click **Delete File**.
11. Click **Disconnect**.
12. Close the **Data Log** window.

To view a data log file after downloading it:

1. Click **Test**, if not already on the test view.
2. Click **Data Log**.
3. Click **Data Explorer**.
4. Click **Open**.
5. Locate and open the data log file.
6. If desired, click **Graph** to view the data on a graph.

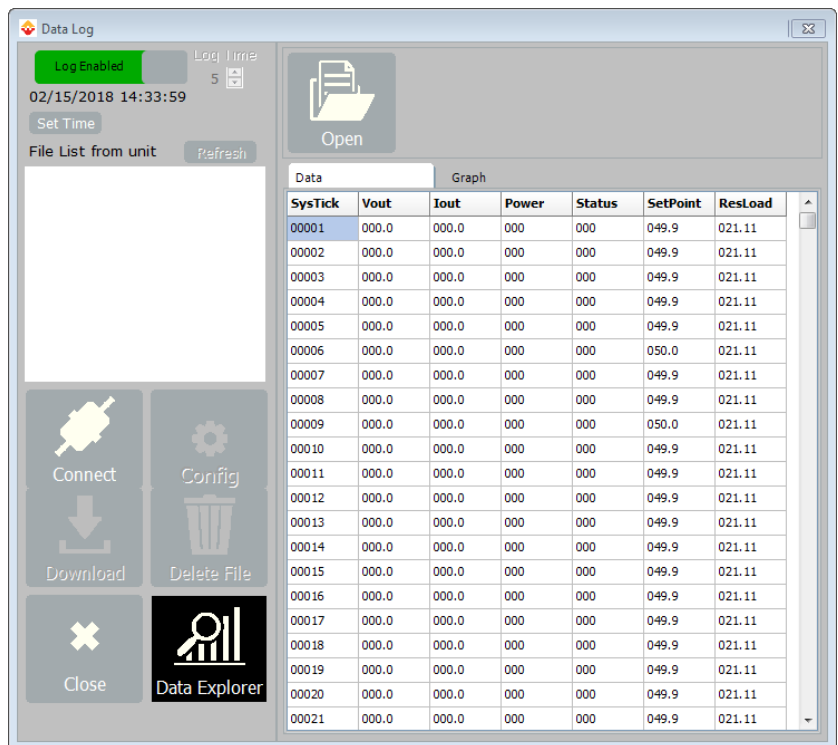

Reference

This section provides explanations of the features found in the ASPYRE Configurator Software.

Program Window

Main Menu

Access these menus.

File menu

- **Exit**—close the program

Setting menu

- **Language**—open the Settings dialog to the language section
- **Serial Port**—open the Settings dialog to the serial port section
- **Option**—open the Settings dialog to the options section

? (Help) menu

- **Message Log**—opens the message view
- **About**—displays the About dialog with the program name and version and Watlow contact information



View selector

Select the view to use:

- **HOME**—the default view
- **ASPYRE**—access the Simple and Test views for a single-phase power controller
- **ASPYRE 3PH**—access the Simple and Test views for a three-phase power controller
- **MSG**—use the tools for monitoring and analyzing serial communication between the computer and the power controller.

Status Bar

Indicates information such as time and date, communications port and baud rate.

Simple view

Use this view to create, save, upload and download recipes, saved sets of parameters settings. You can also use this view to see the settings in a controller.

Access this view by selecting ASPYRE for a single-phase power controller or ASPYRE 3PH for a three-phase power controller and clicking the Simple tab below the main menu, if not already selected.

NOTE! The parameter values are not updated continuously. They are read only when you upload them from the power controller.

Click one of these options to open or create a recipe:

- **Create a New recipe**—create a recipe file with the standard default settings
- **Open existing recipe**—open a previously saved recipe file
- **Upload from unit**—create a new recipe with the settings of the currently connected power controller

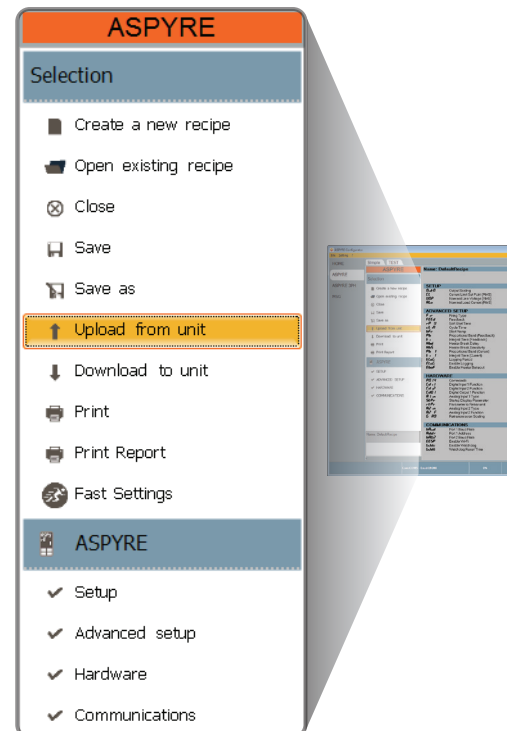

Click one of these options to manipulate the recipe:

- **Close**—close the recipe
- **Save**—save the recipe in a file
- **Save as**—save a copy of the recipe in a file
- **Download to unit**—set the parameters in the currently connected power controller to the values in the recipe
- **Print**—print the recipe (see sample at left)
- **Print report**—print the recipe (see sample at left)
- **Fast Settings**—opens the setup wizard

Click a parameter menu to edit the corresponding parameters:

- **Setup**
- **Advanced setup**
- **Hardware**
- **Communications**

Click a parameter’s value to alter it.

NOTE! Changes to the values here affect the open recipe only. To apply these changes to the power controller settings, download them to the power controller using the Download to unit option.

Par	Display Name	Desc	Val
P016 RW	OutS	Output Scaling	100%
P017 RW	CL	Current Limit Set Point (RMS)	100%
P018 RW	Lim SP	Nominal Line Voltage (RMS)	119V
P038 RW	NLI	Nominal Line Current (RMS)	21.4A

Nun	Par	Description	Value	UM	Hex
016	Out Scale	Output Scaling	100	%	00FF
017	Lim SP	Current Limit Set Point (RMS)	84	%	035B
037	Nominal Line V	Nominal Line Voltage (RMS)	119	V	0077
038	Nominal I	Nominal Load Current (RMS)	21.4	A	00DF

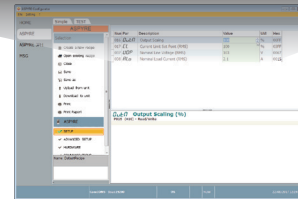

Test view

Use this view to monitor and adjust the operation of the power controller while communicating with it in real time.

Access this view by selecting ASPYRE for a single-phase power controller or ASPYRE 3PH for a three-phase power controller and clicking the Test tab below the main menu, if not already selected.

Use these features to communicate with a power controller:

- **Communications status indicator**—sweeps clockwise when the software is communicating with a power controller and data is updating continuously
- **Connect/Disconnect** button—click to start or stop communication updates with the power controller
- **Address** selector—set the address of the power controller
- **Access Level**—click the value to log in or out. Password is “1111”.
- **Fast Tune**—when logged in, click to open the **Fast Tune** window.
- **Port 2**—set whether the secondary port is used only to read data or to read and write data (does not apply to Modbus® RTU).

Use these features to configure and monitor the digital inputs:

- **Digital input states and functions**—show whether each input detects an open or closed circuit and the function the input performs
- **Digital Input States and Function Selectors**—set the function for each digital input. Click DI1 or DI2 to expand the options.



View these indicators and fields for an overview or the configuration and status of the power controller.

Status and Setup Indicators:

- Digital input status—illuminated when the input detects a closed circuit
- Enable indicator—illuminated when the power controller is enabled
- **Enable/Disable** button—click to enable the power controller if a digital input is not configured for this function
- **ON** indicator—illuminated when there is demand for the output to be on
- **SC** indicator—illuminated when there is a shorted SCR error
- **HB** indicator—illuminated when there is a heater break error
- **TH** indicator—illuminated when the heat sink is over temperature
- **I Lim** indicator—illuminated when the current being called for exceeds the current limit setting
- **Unit Size**—indicates the maximum rated current of the power controller
- **Max Volt**—indicates the maximum rated voltage for the power controller
- **V Aux**—indicates the voltage the auxiliary input is configured to use for powering the electronics
- **Input Type1**—indicates the type of signal analog input 1 is set to measure
- **Input Type2**—indicates the type of signal analog input 2 is set to measure
- **DI1**—indicates digital input 1’s function
- **DI2**—indicates digital input 2’s function
- **Firing**—indicates the firing type the power controller is set to use
- **Feedback**—indicates the type of feedback the power controller is set to use
- **Data Log**—indicates whether or not data is being logged by the power controller

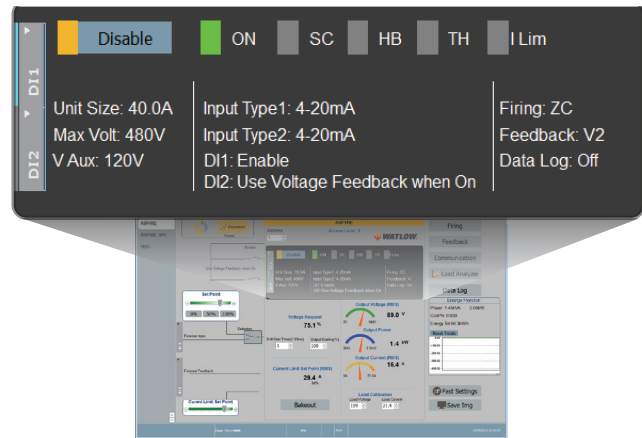

NOTE! The data log indicator appears whether or not the connected power controller has the data logging option.

Use these buttons to access the setup options:

- **Communication**—view and set the options for the communication ports and protocols
- **Feedback**—view and set what is used for feedback
- **Firing**—view and set the firing type and the associated parameters
- **Load Analyzer**—view the graphing utility
- **Data Log**—click to open the Data Log window.

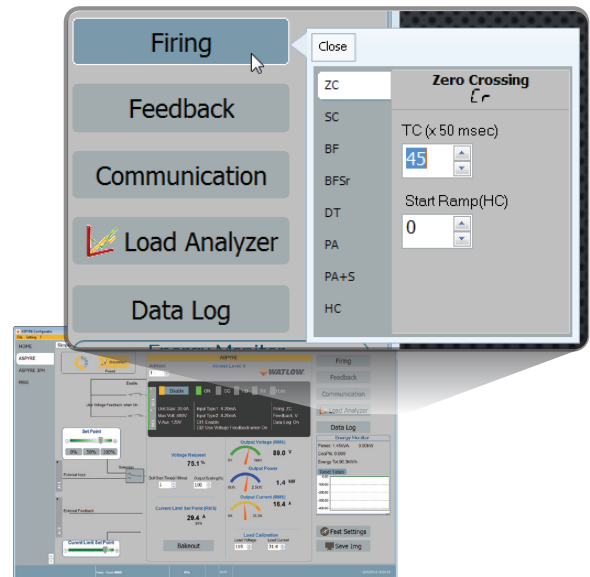

Use these features to configure and monitor the analog inputs:

- Analog Input 1—click Ai 1 to view the signal type
- **Input** button (Local/Remote set point source selector)—click to toggle between using the signal received at analog input 1 (remote) or the slider (local) to set the set point.
- **Set Point**—drag the slider, click the increment (+) or decrement (-) buttons or click one of the three percentages (0%, 50% or 100%) to set the set point when the set point source is set to local.
- Analog Input 2—click Ai 2 to view the signal type and function

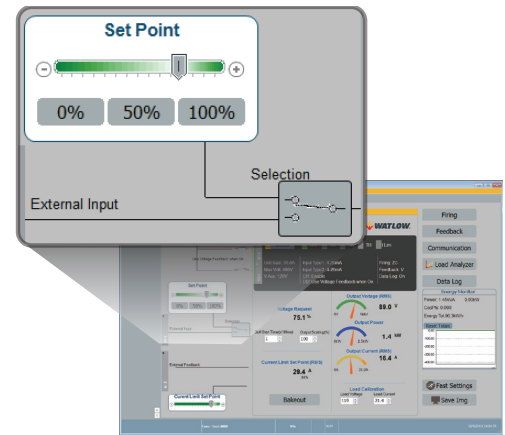

Use these options to configure and monitor the power controller:

- **Power Request**—indicates the set point signal received via analog input 1 as a percent of full scale or as set with the reference slider
- **Soft Start Time**—indicates the time over which set point changes are ramped
- **Output Scaling**—indicates the scaling applied to the set point signal before it is used by the control loop
- **Output Voltage (RMS)**, **Output Power (RMS)** and **Output Current (RMS)** indicators—indicates the RMS current, RMS voltage and RMS power output by the power controller
- **Current Limit Set Point (RMS)**—indicates the current limit set point
- **Bakeout** button—click to view and set the heater bakeout feature options
- **Load Calibration**—set or view the nominal line voltage and nominal load current settings for the application.

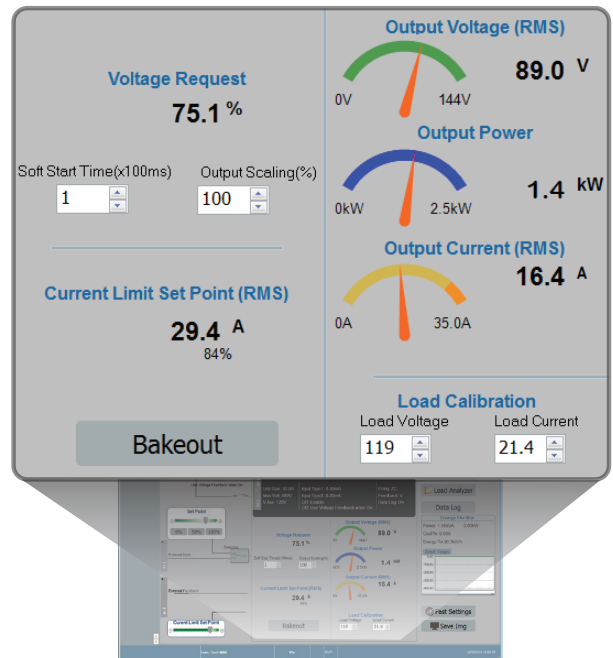

NOTE! The Load Calibration settings, Load Voltage and Load Current define 100% power for the load.

Energy Monitor—indicates power, power factor and energy usage over time which may be reset with the **Reset Totals** button.

Data Log—use to configure the data logging feature if present and retrieve data logs.

Fast Settings—opens the setup wizard.

Save Image—click to save a JPEG file with an image of the test view.

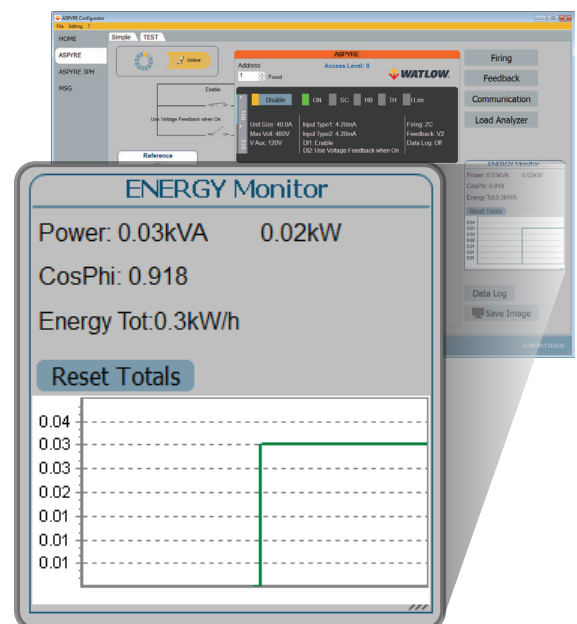

Load Analyzer (ASPYRE Scope)

Click **Load Analyzer** on the test view to open this window.

For each of up to three channels (Ch 1, Ch 2 and Ch 3) configure a pen on the graph:

- **On/Off** button—click to start trending data
- **PV**—choose the parameter to trend
- **Show**—set this option to display the trend
- **Show Mark**—set this option to display data markers along the trend in the graph area

Live!—click to view a detailed graph of the current in the Live! window.

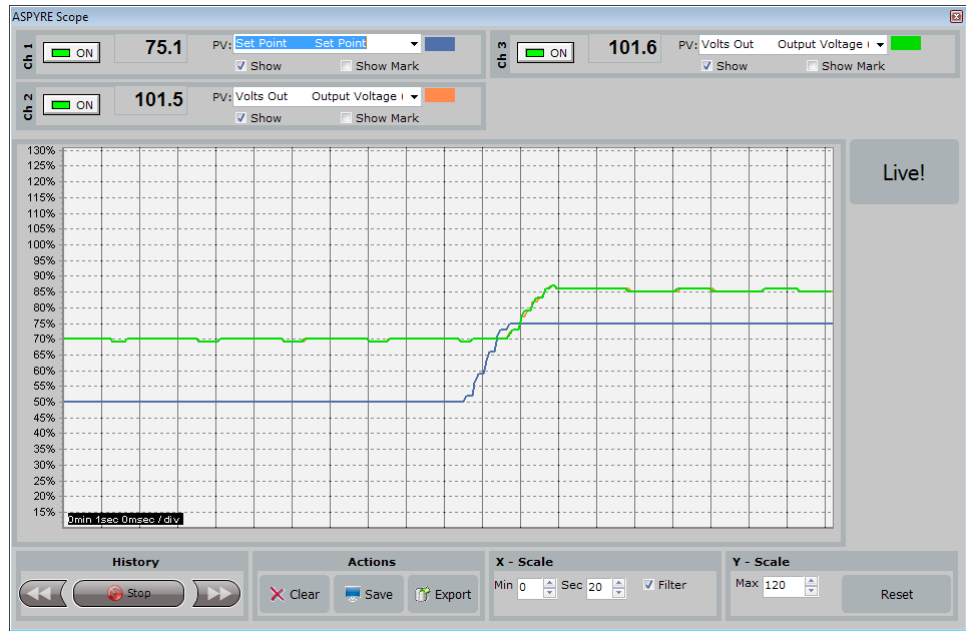

Use the **History** options to control the movement of the chart

- **Scroll left**—click to move the chart left to view more recent data
- **Stop/Play**—click to toggle chart movement on and off
- **Scroll right**—click to move the chart right to view older data

Use the **Actions** to:

- **Clear**—click to clear the data from the graph
- **Save**—click to save a JPEG image of the ASPYRE Scope window with the current trends
- **Export**—click to open a window and that includes the trend graph and table with the currently displayed data that can be saved as a JPEG or exported to a CSV file.

Use the **X - Scale** settings to adjust the horizontal (time) axis:

- **Min**—set the number of minutes of data displayed
- **Sec**—set the number of seconds of data displayed
- **Filter**—set this option to filter the data

Use the **Y - Scale** settings to adjust the vertical (percent of full scale) axis

- **Max**—set the maximum value for the vertical axis
- **Reset**—click to reset the vertical axis scaling

NOTE! Use the increment (up arrow) and decrement (down arrow) buttons to adjust the x and y scales. Numeric entry does not allow the full range of values to be set.

Live! Scope

This view provides a detailed graph of instantaneous current over a few sample cycles. The data updates automatically.

Use these options to configure the displayed data:

- **Enable**—set this option to view the current on the graph
- **Save**—click to save a JPEG image of the ASPYRE Scope window with the current trend
- **Show Data**—click to open the **Data** pane to the right of the graph that shows the data points for the current sample

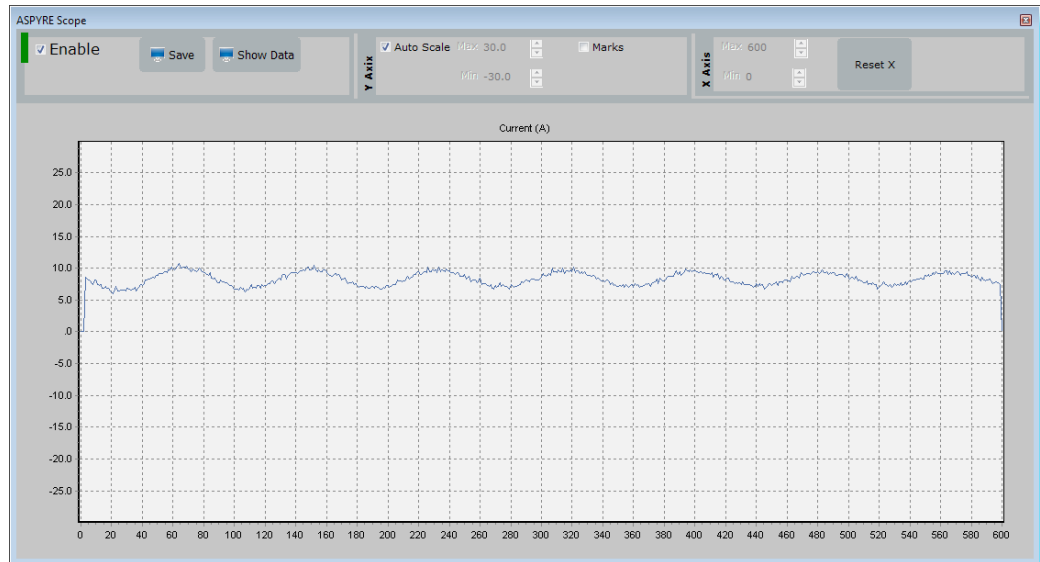

Y Axis:

- **Auto Scale**—set this option to have ASPYRE Configurator automatically adjust the vertical and horizontal axis settings
- **Max**—set the high end of the vertical axis
- **Min**—set the low end of the vertical axis
- **Marks**—set this option to display data markers along the trend in the graph area

X Axis (future use):

- **Max**
- **Min**
- **Reset X**

Data Log Window

Use the data log window to set up data logging and manage the memory used for data log files in the power controller.

- **Log Enabled/Log Disabled** slider—starts and stops data logging. Must be set to *enabled* to configure logging or retrieve files.
- **Log Time**—the time between data log records in seconds
- **Config**—opens the data log configuration window
- **File List**—lists the data log files available in the power controller
- **Connect**—displays and allows downloading and deleting data log files in the power controller
- **Disconnect**—stops displaying data log files in the power controller
- **Download**—copies the selected file from the power controller to the computer
- **Delete File**—erases the selected file from the power controller
- **Close**—closes the **Data Log** window
- **Data Explorer**—expands the data explorer

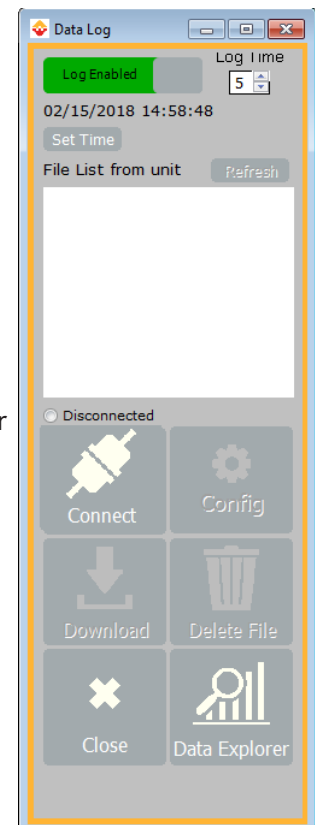

Data Log Configuration window

Use the data log configuration window to view and set which parameters are logged.

- **Close**—closes the window
- **Load**—reads and displays the list of parameters being logged
- **Logged parameters list**—the parameters being logged
- **Par**—view or enter the Modbus® address of the parameter to log
- **Name**—view or choose the name of a parameter to log
- **Tab Name**—view or enter the name of the logged parameter displayed in the log file
- **+ button**—adds a row to the list
- **- button**—removes the last row from the list
- **Save**—sends the list of parameters to be logged to the controller

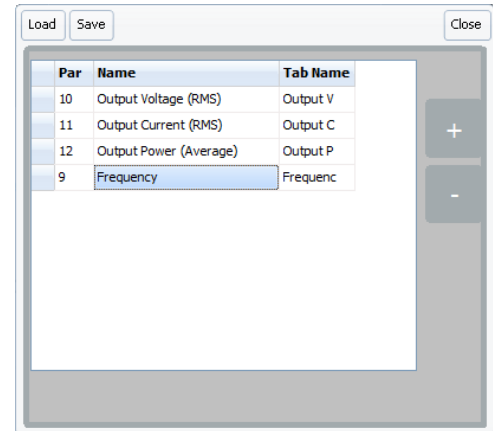

Data Explorer

Use the data explorer to view data logged in files that have been downloaded from the power controller.

- **Open**—displays the open file dialog. Use this to open and display a data log that has been saved on the computer.
- **Data**—click to display the data from the log file in a table
- **Graph**—click to display the data from the log file in a graph
- **Data table**—displays the contents of the data log file.

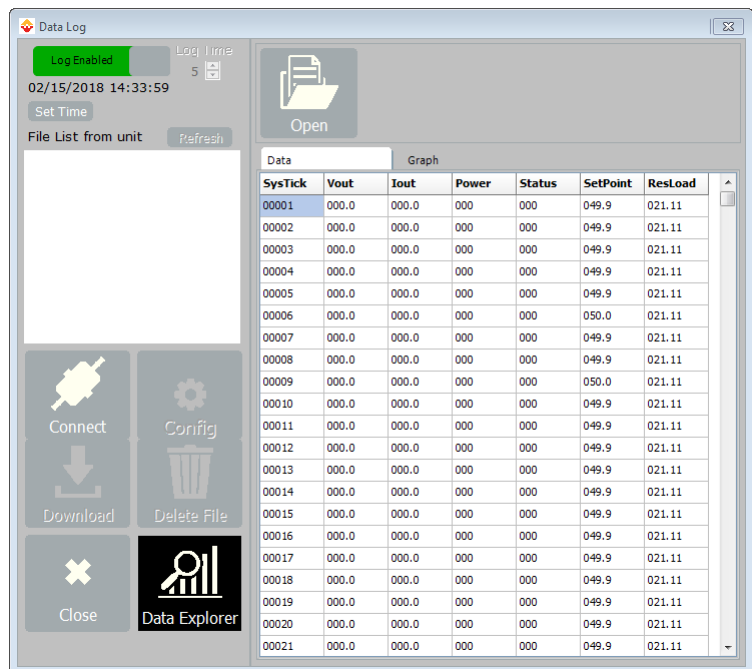

Data Explorer Graph

Use the data explorer graph view data logged in files that have been downloaded from the power controller.

- Graph series check boxes—select the data to include on the graph.
- Settings (gear icon)—click to open the graph settings dialog to set the range of the graph and other options
- Graph—displays the contents of the data log file.

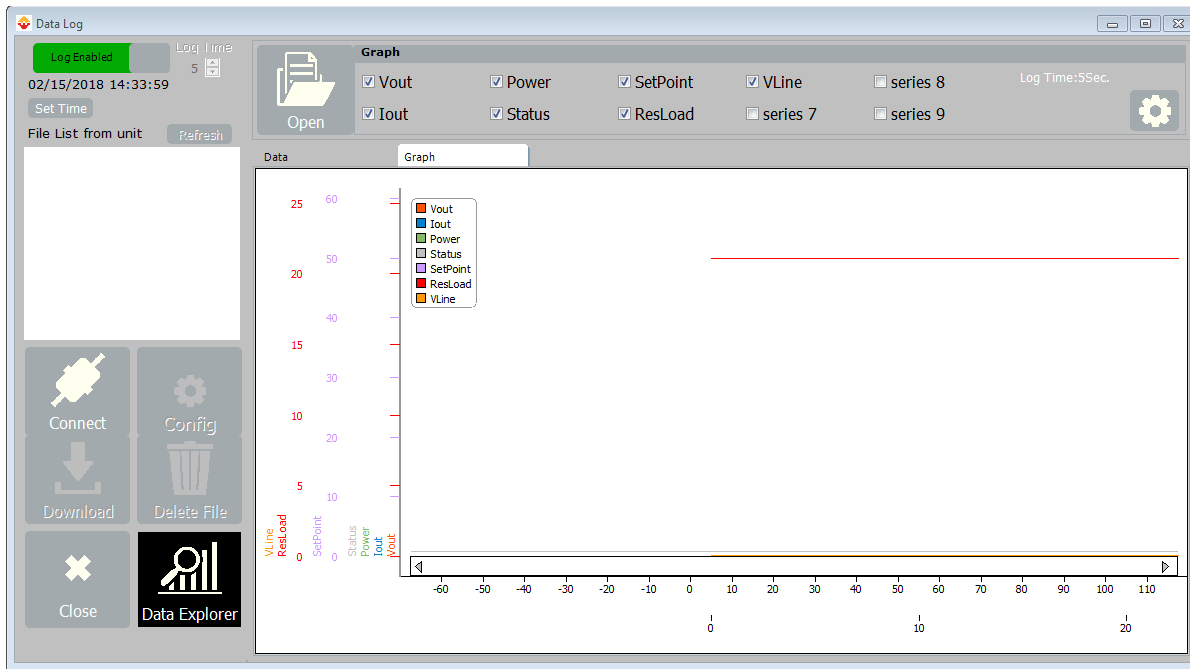

MSG view

Use the message view to monitor communication activity between the computer and the power controller.

- **PORT/COM**—view when the COM port is accessed and its settings
- **MODBUS/READ Area**—view the parameters being polled
- **MODBUS/WRITE Area**—view what parameters are being set and the values to which they are being set
- **MODBUS/Log Msg**—view the raw Modbus® messages (in hex) between ASPYRE Configurator and the power controller
- **MODBUS/Status**—view the status and settings of the COM port
- **SYSTEM/Memory**—view the memory usage of the ASPYRE Configurator program on the computer

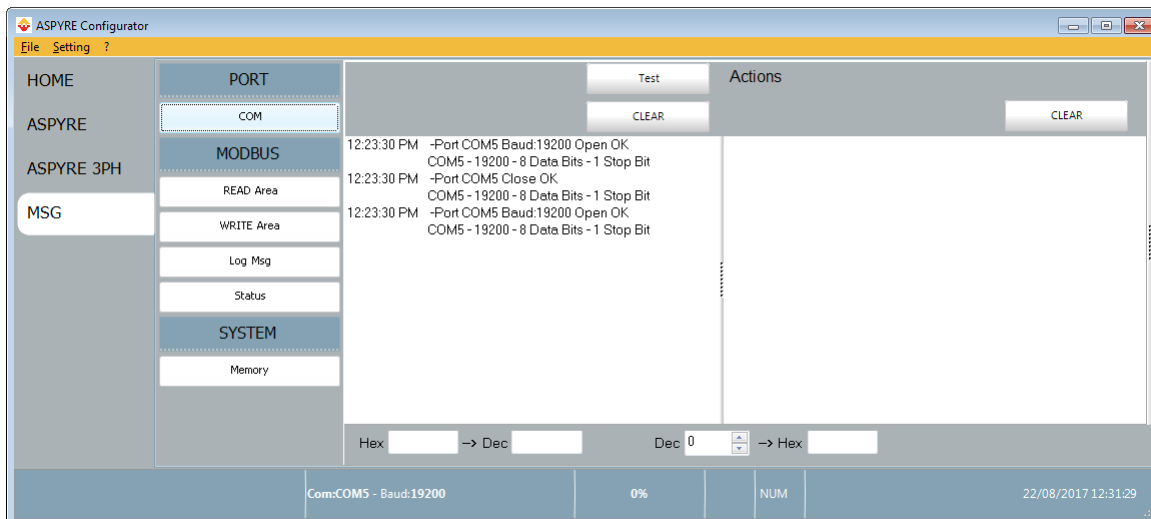

Settings window

Use this window to choose user-settable options for the ASPYRE Configurator software. To open the Settings window, choose any of the items on the Settings menu, then select the tab you want.

Language:

- **Available Languages**—choose the language used in the program

Serial Port:

- **Test**—click to test for communication with a power controller via the selected port
- **Port**—select the computer’s COM port to use to communicate with power controllers
- **Baud rate**—select Auto to allow ASPYRE Configurator to set the baud rate for the COM port or deselect the option to set the baud rate yourself

Options:

- **List Options**—set whether or not parameter values are displayed in hexadecimal in simple view recipes
- **Directory**—set the directories in which recipes and images are saved
- **Disable Check Type**—set to allow communication with power controllers that are not precise matches for the supported types.

View:

- **Hide Tool Bar**—future use
- **Hide Status Bar**—select to hide the status bar that appears at the bottom of the program window.

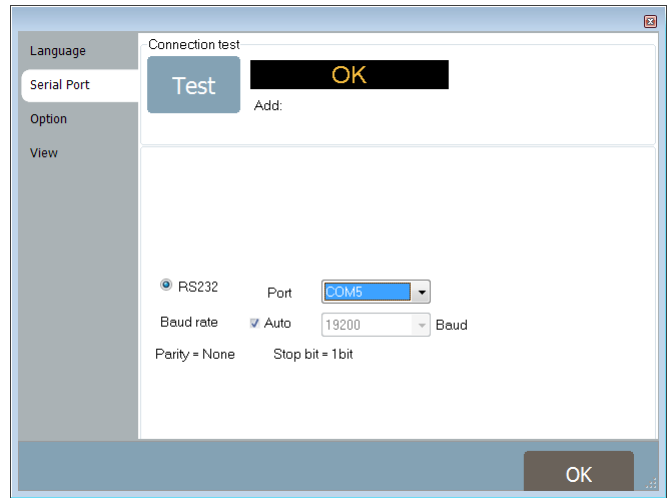

7

Parameter Reference

This chapter describes the parameters accessed via the control panel, ASPYRE Configurator software and serial communications. To learn how to access the menus described below see “Menu Navigation” on page 36.

Alarm Function

Choose for which conditions the digital output indicates an alarm. The output always indicates an alarm when the heat sink is over temperature. The digital output is energized for normal operating conditions and de-energized when the power controller is off or when there is an alarm.

NOTE! The power controller monitors for heater break or shorted SCR conditions only when included in the option selected for Alarm Output Function.

Option	Description
None	SCR over temperature only
Heater Break	Heater break or SCR over-temperature
SCR Short	Shorted SCR or SCR over-temperature
I Limit*	Current limit or SCR over-temperature
HB / SC	Heater break, shorted SCR or SCR over-temperature
HB / IL*	Heater break, current limit or SCR over-temperature
SC / IL*	Shorted SCR, current limit or SCR over-temperature
All*	Heater break, shorted SCR, current limit or SCR over-temperature
These options may be set via communication only	Communication watchdog error or SCR over-temperature
	Communication watchdog error, heater break or SCR over-temperature
	Communication watchdog error, shorted SCR or SCR over-temperature
	Communication watchdog error, heater break, shorted SCR or SCR over-temperature
	Communication watchdog error, SCR over-temperature or current limit*
	Communication watchdog error, heater break, SCR over-temperature or current limit*
	Communication watchdog error, shorted SCR, SCR over-temperature or current limit*

*Models with current limit

Default: Heater Break

Menu: Hardware (read-write)

Analog In 1 [Signal Type]

Choose the type of signal to be measured by analog input 1.

Option	Description
0-10V / 10k Pot	0 to 10 Vdc or 10,000Ω potentiometer
4-20mA	4 to 20 mAdc
0-20mA	0 to 20 mAdc

Default: 0-10V / 10k Pot

Menu: Hardware (read-write)

Analog In 1 [Value]

Indicates the percent of full scale measured by analog input 1.

Range: 0 to 100.0%

Menu: Monitor (read-only)

Analog In 2 [Signal Type]

Choose the type of signal to be measured by analog input 2.

Option	Description
0-10V / 10k Pot	0 to 10 Vdc or 10,000Ω potentiometer
4-20mA	4 to 20 mAdc
0-20mA	0 to 20 mAdc

Default: 0-10V / 10k Pot

Menu: Hardware (read-write)

Analog In 2 [Value]

Indicates the percent of full scale measured by analog input 2.

Range: 0 to 100.0%

Menu: Monitor (read-only)

Analog In 2 Function

Choose how the signal measured by analog input 2 is used.

Option	Description
I Limit*	Current limit set point
Feedback	External feedback
Set Point	Power demand set point

*DT1 and DT3 models

Default: I Limit or Feedback for units without current limit option

Menu: Hardware (read-write)

Aux Voltage

Indicates the measured line voltage.

Range: 0 to 1023V

Menu: Monitor (read-only)

Bakeout Current (Models with Current Limit)

Set the maximum current for the heater bakeout.

Range: 0 to 999.9 A

Default: 0

Menu: Advanced Setup (read-write)

Bakeout Off Time (Models with Current Limit)

Set the maximum off time before the heater bakeout is required.

Range: 1 to 1,999 minutes

Default: 1

Menu: Advanced Setup (read-write)

Bakeout Ramp Time (Models with Current Limit)

Set the total time for the bakeout ramp in minutes.

Range: 1 to 1,999 minutes

Default: 1

Menu: Advanced Setup (read-write)

Command Bits

Set the bit corresponding to the option to be enabled or command to be executed.

Bit	Description	Clear Bit (0)	Set Bit (1)
0	Not used		
1	Local/remote set point*	Remote	Local
2	Enable Output (if no digital input is configured as Enable)**	Not Enabled	Enable output
3	Not used		
4	Local/remote current limit	Remote (set via Analog input 2)	Local (set via keypad or communications)
5 to 15	Not used		

*When using a power controller with a secondary communication port other than Modbus® RTU, with Port 2 Access set to *Read and Write*, the local / remote option is determined only by command bit 1 regardless of whether or not a digital input is configured to set this option.

**When using a power controller with a secondary communication port other than Modbus® RTU, with Port 2 Access set to *Read and Write* and the power controller configured to be enabled by a digital input, the power controller is enabled only when the digital input and command bit 2 are *both* on.

Set the value corresponding to the combination of features you want to enable.

Value	Set Point	Enable Output	Current Limit
0	Remote	Off	Remote
2	Local	Off	Remote
4	Remote	On	Remote
6	Local	On	Remote
16	Remote	Off	Local
18	Local	Off	Local
20	Remote	On	Local
22	Local	On	Local

Cycle Time

Set the duration of one on-off cycle in increments of 50 ms. Applies to zero crossing; see “Zero-Crossing” on page 76.

Range: 0 to 255 (0 to 12.75 sec)

Default: 30 (1.5 sec)

Menu: Advanced Setup (read-write)

Delay

Set the firing delay in degrees. Applies to burst fire with delay trigger. For more information see “Burst Firing with Delayed Triggering (DT1 and DT3 Models)” on page 79.

Range: 0 to 90°

Default: 60°

Menu: Advanced Setup (read-write)

Digital In 1

Indicates the state of the signal to digital input 1.

Option
Off
On

Menu: Monitor (read-only)

Digital In 1 Function

Choose how the signal detected by digital input 1 is used.

Option	Description
Enable ¹	Enable power output
Voltage Feedback	Use voltage feedback when on
Local / Remote ²	Local when on / remote when off
Phase Angle ³	Use phase angle firing when on
Set Point Analog In 1 / 2	Select remote set point source: analog input 1 when off or analog input 2 when on
Logging	Enable logging
Heater Bakeout ⁴	Enable heater bakeout

¹When using a power controller with a secondary communication port other than Modbus® RTU, with Port 2 Access set to *Read and Write* and the power controller configured to be enabled by a digital input, the power controller is enabled only when the digital input and command bit 2 are *both* on.

²When using a power controller with a secondary communication port other than Modbus® RTU, with Port 2 Access set to *Read and Write*, the local / remote option is determined only by command bit 1 regardless of whether or not a digital input is configured to set this option.

³DT1 and DT3 models

⁴Models with current limit

Default: Voltage Feedback

Menu: Hardware (read-write)

Digital In 2

Indicates the state of the signal to digital input 2.

Option
Off
On

Menu: Monitor (read-only)

Digital In 2 Function

Choose how the signal detected by digital input 2 is used.

Option	Description
Enable ¹	Enable power output
Voltage Feedback	Use voltage feedback when on
Local / Remote ²	Local when on / remote when off
Phase Angle ³	Use phase angle firing when on
Set Point Analog In 1 / 2	Select remote set point source: analog input 1 when off or analog input 2 when on
Logging	Enable logging
Heater Bakeout ⁴	Enable heater bakeout

¹When using a power controller with a secondary communication port other than Modbus® RTU, with Port 2 Access set to *Read and Write* and the power controller configured to be enabled by a digital input, the power controller is enabled only when the digital input and command bit 2 are *both* on.

²When using a power controller with a secondary communication port other than Modbus® RTU, with Port 2 Access set to *Read and Write*, the local / remote option is determined only by command bit 1 regardless of whether or not a digital input is configured to set this option.

³DT1 and DT3 models

⁴Models with current limit

Default: Enable

Menu: Hardware (read-write)

Enable

Indicates whether or not the power controller is enabled. The enable signal must be on for the unit to output power to the load.

Option
Off
On

Menu: Monitor (read-only)

Ethernet Address

Indicates the IP address of the power controller with an Ethernet communication option.

Range: 0 to 255 each part

Default: 193.168.0.221 (Modbus® TCP), 193.168.0.220 (EtherNet/IP™)

Menu: Communication (read-only)

Ethernet Subnet

Indicates the subnet mask of the power controller with an Ethernet communication option.

Range: 0 to 255 each part

Default: 255.255.255.0

Menu: Communication (read-only)

Ethernet Gateway

Indicates the gateway address of the power controller with an Ethernet communication option.

Range: 0 to 255 each part

Default: 0.0.0.0

Menu: Communication (read-only)

Feedback

Choose the measured value used as feedback for controlling to the set point. See “Firing Types” on page 76.

Option	Description
Voltage ²	Voltage squared
None	No feedback
Current ²	Current squared
Voltage	Voltage
Current	Current
Power	Power
External	External signal via analog input 2

Default: Voltage

Menu: Advanced Setup (read-write)

Firing

Choose how the output turns on and off to deliver the requested percent power. See “Feedback” on page 72.

Option
Zero Cross
Single Cycle*
Burst Fire
Phase Angle**
Burst Fire Start Ramp**
Phase Angle Soft Start**
Burst Fire Delay Trigger**
BF Strt Rmp Delay Trigger**
Half Cycle*
Half Cycle Safety Ramp*

*DT1 models

**DT1 and DT3 models

Default: Burst Fire

Menu: Advanced Setup (read-write)

Frequency

Indicates the frequency of the power input.

Range: 0 to 655.35 Hz

Menu: Operator (read-only)

Half Cycles to Delay

Set the number of half cycles with a delay for burst fire delay trigger firing.

Range: 0 to 255

Default: 1

Menu: Advanced Setup (read-write)

Heater Bakeout (Models with Current Limit)

Enable or disable the heater bakeout feature.

Option
Off
On

Default: Off

Menu: Advanced Setup (read-write)

HH:MM:SS

Indicates the time setting in the real time clock.

Default: 00:00:00 January 1, 2000

Menu: Monitor (read-only), ASPYRE Configurator Test view (read-write)

Host Name

Indicates the name of the power controller.

Default: none

Menu: Communication (read-only)

Htr Break Delay

Set a delay between when the resistance drops below the value set for heater break sensitivity and when the heater break alarm is indicated. This is set in increments of 50 ms.

Range: 0 to 255 (0 to 12.75 seconds)

Default: 50 (2.5 seconds)

Menu: Advanced Setup (read-write)

Htr Break Sensitivity

Set the threshold of resistance that activates the heater break alarm. This setting is in percentage of the nominal load resistance.

Range: 0 to 100%

Default: 20%

Menu: Advanced Setup (read-write)

I Limit (Models with Current Limit)

Set the maximum percent of the nominal current the power control allows. This parameter is in RMS current by default, but can be set to limit peak current. "Limit Peak Current (Models with Current Limit)" on page 61.

Range: 0 to 100.0%

Default: 100.0%

Menu: Operator (read-only), Setup (read-write)

I Limit Local / Remote (Models with Current Limit)

Choose how the current limit is set.

Option	Description
Analog In 2	Set point set via analog input
Local	Set point set via keypad or communications

Default: Local

Menu: Hardware (read-write)

I Output

Indicates the average (RMS) current of all phases.

Range: 0 to 999.9A

Menu: Operator (read-only)

Integral Current (Models with Current Limit)

Set how aggressively the integral acts in the current loop. A smaller setting yields a larger adjustment to the output for a given deviation over a given time.

Range: 0 to 255

Default: 30

Menu: Advanced Setup (read-write)

Integral Power

Set how aggressively the integral part of the control algorithm acts. A smaller setting yields a larger adjustment for a given deviation over a given time.

Range: 0 to 255

Default: 10

Menu: Advanced Setup (read-write)

kVA Real Time

Indicates the instantaneous apparent power consumption.

Range: : 0 to 655.35 kVA

Menu: Monitor (read-only)

kW Real Time

Indicates the instantaneous real power consumption taking power factor into account.

Range: : 0 to 9,999 kW

Menu: Monitor (read-only), ASPYRE Configurator Test view (read-write)

kW Total

Indicates the totalized energy consumption in kWh. The kW total is stored with tenths resolution in two registers with the most significant word in the higher register. Set kW Real Time to zero (0) to reset this total.

Range: 0 to 429,429,729.5 kWh

Default: 0

Menu: Monitor (read-only)

Leg 1 I Output (DT2 and DT3 Models)

Indicates the RMS current measured for leg 1.

Range: 0 to maximum current

Menu: Operator (read-only)

Leg 2 I Output (DT2 and DT3 Models)

Indicates the RMS current measured for leg 2.

Range: 0 to maximum current

Menu: Operator (read-only)

Leg 3 I Output (DT2 and DT3 Models)

Indicates the RMS current measured for leg 3.

Range: 0 to maximum current

Menu: Operator (read-only)

Limit Peak Current (Models with Current Limit)

Set whether to limit the peak current or RMS current.

Option
RMS Current
Peak Current

Default: 0

Menu: ASPYRE Configurator Test view (read-write)

Load Ω

Indicates the resistance of the load.

Range: 0 to 655.35 Ω

Menu: Operator (read-only)

Logging

Enable or disable data logging on the internal SD card.

Option
Off
On

Default: Off

Menu: Advanced Setup (read-write)

Logging Interval

Set how often data is logged.

Range: 0 to 255 seconds

Default: 5 seconds

Menu: Advanced Setup (read-write)

Max Current

Indicates the maximum current capacity of the power controller.

Range: 0 to 9,999A

Menu: Monitor (read-only)

Max Voltage

Indicates the maximum voltage rating of the power controller.

Range: 0 to 1,023V

Menu: Monitor (read-only)

Min Cycles

Set the minimum number of on cycles and off cycles for burst firing.

Range: 0 to 255

Default: 8

Menu: Advanced Setup (read-write)

MM/DD/YY

Indicates the date setting in the real time clock.

Default: 00:00:00 January 1, 2000

Menu: Monitor (read-only), ASPYRE Configurator Test view (read-write)

Neutral Connected (DT2 and DT3 Models)

For three-phase loads, set whether or not the AC neutral is connected to the load.

Option	Description
No Neutral	Delta or ungrounded wye wiring
Neutral Connected	Grounded wye wiring

Menu: Advanced Setup (read-write)

Nominal I

Set the nominal load current.

Range: 0 to 999.9 A

Default: maximum current for power control

Menu: Operator (read-only), Setup (read-write)

Nominal V

Set the nominal value for the line voltage input.

Range: 0 to 1023V

Default: 220V

Menu: Operator (read-only), Setup (read-write)

Out Scale

Set the percentage by which the set point is scaled. For example, if a 0 to 10V analog input providing the set point is 5V and Output Scaling is 80%, then the effective set point is 40%.

Range: 0 to 100.0%

Default: 100%

Menu: Setup (read-write)

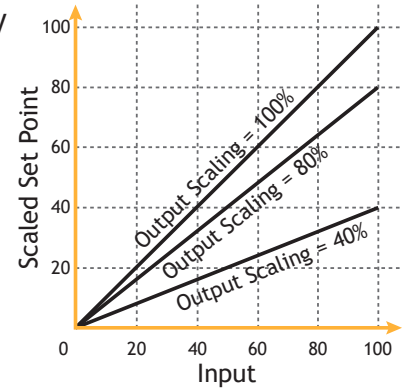

Port 1 Address

Set the address for the primary serial port.

Range: 0 to 255

Default: 1

Menu: Communication (read-write)

Port 1 Baud

Choose the baud rate for the primary serial port.

Option
9600
19200
38400
115200

Default: 38400

Menu: Communication (read-write)

Port 2

Indicates the type of secondary communication port.

Option	Description
Disabled	No secondary communications port
Ethernet	Protocols that use Ethernet
RS-485	RS-485

Menu: Hardware (read-write)

Port 2 Access

Use this parameter to disable writing data via port 2 and disable the secondary communication watchdog. Note for protocols other than Modbus® RTU the output from the power controller will be disabled if data is not written at least as often as the communications watchdog is set to expect communications. See “Communication Watchdog” on page 97

Option	Description
Read and Write	Data may be written via port 2 and the watchdog function is enabled.
Read Only	Data may not be written via port 2 and the watchdog function is disabled.

Default: Read and Write

Menu: Communication (read-write)

Port 2 Address

Set the address for the secondary serial port or the Profibus address.

Range: 0 to 255

Default: 0

Menu: Communication (read-write)

Port 2 Baud

Choose the baud rate for the secondary serial port.

Option
9600
19200
38400
115200

Default: 9600

Menu: Communication (read-write)

Power

Indicates the average power output as a percent of full power.

Range: 0 to 100%

Menu: Operator (read-only)

Power Factor

Indicates the power factor of the output power.

Range: 0 to 1.000

Menu: Operator (read-only)

Prop Band Current (Models with Current Limit)

Set the proportional relationship between the output and the feedback for the current limit control loop. This setting determines how big a correction the proportional part of the control algorithm makes when the feedback deviates from set point. Set the gain for the current loop. A smaller proportional band yields a larger adjustment for a given deviation.

Range: 0 to 255%

Default: 15%

Menu: Advanced Setup (read-write)

Prop Band Power

Set the proportional relationship between the output and the feedback for the power demand control loop. This setting determines how big a correction the proportional part of the control algorithm makes when the feedback deviates from set point. A smaller proportional band yields a larger adjustment for a given deviation.

Range: 0 to 255%

Default: 5%

Menu: Advanced Setup (read-write)

Release

Indicates the software release date year and week (yyww).

Range: 0 to 65535

Menu: Monitor (read-only)

Remote SP

Choose the source for the remote set point. If a digital input is configured to select between the analog inputs as the source of the set point, the digital input takes precedence and this parameter indicates the analog input selected with the digital input.

Option
Analog Input 1
Analog Input 2

Default: Analog Input 1

Menu: Setup (read-write)

Retransmit (Models with Retransmit)

Choose which parameter is retransmitted by the analog output.

Option	Description
None	Do not retransmit a value
Set Point	Set point
V Output	RMS voltage output
I Output	RMS current output
Power	Average output power

Default: Power

Menu: Hardware (read-write)

Retransmit Scale (Models with Retransmit)

Set the value of the retransmitted parameter to be represented by the full scale of the analog output. See the table below.

Range: 0 to 9,999

Default: 0

Menu: Hardware (read-write)

Retransmit Settings

Retransmit	Recommended Retransmit Scaling	Resulting Signal (4 to 20mADC)	Resulting Signal (0 to 20mADC)	Resulting Signal (0 to 10VDC)
Set point	100	4mADC = 0% 20mADC = 100%	0mADC = 0% 20mADC = 100%	0VDC = 0% 10VDC = 100%
V Output	xV where x is the Nominal Line Voltage	4mADC = 0% 20mADC = xV	0mADC = 0% 20mADC = xV	0VDC = 0% 10VDC = xV
I Output	xA where x is the Nominal Load Current	4mADC = 0A 20mADC = xA	0mADC = 0A 20mADC = xA	0VDC = 0A 10VDC = xA
Power	100	4mADC = 0% 20mADC = 100%	0mADC = 0% 20mADC = 100%	0VDC = 0% 10VDC = 100%

Retransmit Type (Models with Retransmit)

Choose the type of signal for the retransmit output.

Option
0-10V
4-20mA
0-20mA

Default: 4-20mA

Menu: Hardware (read-write)

Safety Ramp Duration

Enable the safety ramp feature and set how long the ramp takes by setting a value greater than zero in increments of 50ms.

Range: 0 to 65,535 x50ms

Default: 10 (500 ms)

Menu: Advanced Setup (read-write)

Safety Ramp Off Time

Set the minimum amount of time the power to the load is off before the safety ramp occurs in increments of 50ms.

Range: 0 to 65,535 x50ms

Default: 200 (10 seconds)

Menu: Advanced Setup (read-write)

SCR Temperature

Indicates whether the SCR is below or above the factory-set trip point.

Option	Description
Disabled	No sensor present / temperature below limit
Over Temp	Over temperature

Menu: Monitor (read-only)

Serial Number

Indicates the serial number of the power controller.

Range: 1 to 9999 (each part)

Menu: Monitor (read-only)

Set Point

View the set point.

Range: 0 to 100%

Menu: Operator (read-write)

Set Point Source

Indicates whether the power controller is in local or remote set point mode.

Option	Description
Remote	Set point set via analog input
Local	Set point set via keypad or communications

Default: Remote

Menu: Monitor (read-only)

Soft Start

Set the duration of the soft start in increments of 50 ms. The power controller ramps set point changes over the time set here. For more information see "Soft Start" on page 82.

Range: 0 to 255 (0 to 12.75 seconds)

Default: 8 (400 ms)

Menu: Setup (read-write), Advanced Setup (read-write)

Start Ramp

Set the number of half cycles over which the power ramps each time the output turns on. Available on DT1 and DT3 models. For more information see "Start Ramp (DT1 and DT3 Models)" on page 82.

Range: 0 to 1,023

Default: 0

Menu: Advanced Setup (read-write)

Startup Display

Choose which parameter is displayed on the home page at power-up.

Option
Current
Voltage
Power

Default: Current

Menu: Hardware (read-write)

Status Bits

Indicates the state of various features.

Bit	Description	Clear Bit (0)	Set Bit (1)
0	Shorted SCR alarm	No alarm	Alarm
1	Heater Break Alarm	No alarm	Alarm
2	Output Enabled	Disabled	Enabled
3	Not used		
4	Current Limit Alarm	No alarm	Alarm
5	Thermal Alarm	No alarm	Alarm
6	Communication Alarm (WD)	No alarm	Alarm
7	Not used		
8	Digital input 1 status	Off	On
9	Digital input 2 status	Off	On
10	Unbalance load alarm	No alarm	Alarm
11	Not used		
12	Not used		
13	Phase Loss (loss of power on one or more legs)	No alarm	Alarm
14	Heater Bakeout	Off	On
15	Latched Thermal Alarm (indicates thermal alarm has occurred since last power cycle)	Off	On

Access: Read-only

Thermal Alarm Counter

Indicates the number of times the SCR Over Temp alarm has occurred.

Range: 0 to 65,535

Menu: ASPYRE Configurator Test view (read-only)

Unit Type

Indicates the type of power controller.

Option	Description
1 Leg	Single phase
2 Leg	Two-Leg, three-phase
3 Leg	Three-Leg, three-phase (zero cross)
3 Leg PA	Three-Leg, three-phase (phase angle)

Menu: Monitor (read-only)

User Access Level

Set this parameter to the code corresponding to the level of access to be granted for writing parameter values via the primary communications port.

Range: 0 to 65,535

Value	Allows...
0	Access to monitor and operation parameters
1111	Access to setup parameters

Menu: ASPYRE Configurator Test view (read-write)

V Input

Indicates the average (RMS) voltage input.

Range: 0 to 6,553.5V

Menu: Operator (read-only)

V Output

Indicates the average (RMS) voltage of all phases.

Range: 0 to 1,023V

Menu: Operator (read-only)

Version

Indicates the software version number (x.xx.x).

Range: 0 to 65535

Menu: Monitor (read-only)

Watchdog

Enable or disable the watchdog on the primary serial port.

Option
Off
On

Default: Off

Menu: Communication (read-write)

Watchdog Reset Time

Set the amount of time to wait for a message before triggering the watchdog error.

Range: 0 to 255 seconds

Default: 5 seconds

Menu: Communication (read-write)

Wi-Fi

Enable or disable Wi-Fi communication.

Option
Off
On

Default: Off

Menu: Communication (read-write)

Wi-Fi Address

Indicates the IP address of the WiFi connection in the power controller.

Range: 0 to 255 (each part)

Default: 192.168.4.1

Menu: Communication (read-only)

8

Features

This chapter describes the programmable features of the ASPYRE power controller.

CAUTION: all parameter settings should be determined only by qualified persons.

ATTENTION : Toutes les configurations de paramètre doivent être déterminées uniquement par le personnel qualifié.

Closed Loop Control

The ASPYRE power controller measures the voltage and current delivered to the load, and depending on how it is configured, corrects for, among other things, variations in line voltage and load resistance.

DT1 Models and DT3 Models

Single-phase and three-phase, three-leg models that include the current limit option, use two control loops to regulate power to the load. One loop attempts to drive the output to match the power demand set point. The other loop attempts to drive the current through the load to match the current limit. By using the lesser of the outputs from the two control loops, the power is controlled to the set point but prevented from exceeding the current limit.

While the current limit loop overrides the power demand loop, the output is phase angle fired and the display indicates the current limit alarm. If the alarm output function is set to indicate the current limit, the alarm relay is de-energized.

Closed Loop Control (DT1 and DT3 models)

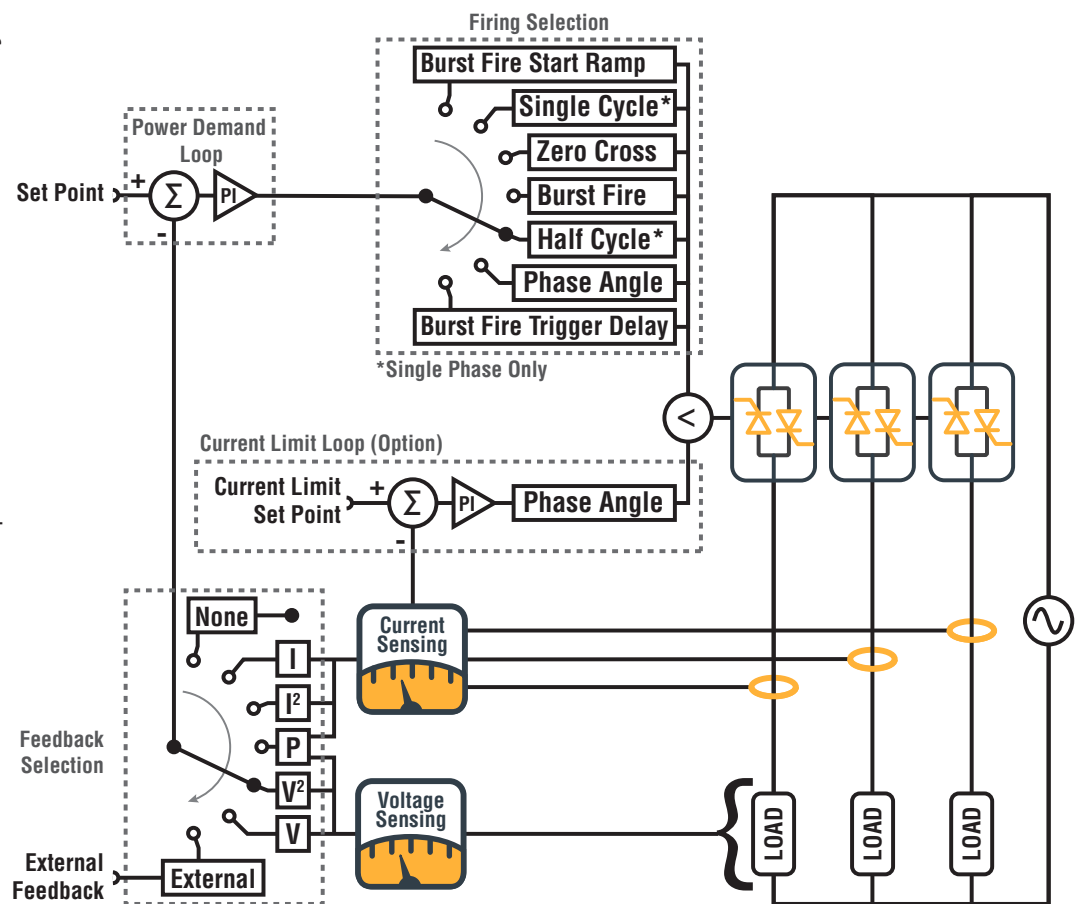

Each loop adjusts its output based on its measurement of error, the difference between the set point and the measured and calculated feedback. For the current limit loop, the error is the difference between the current

limit set point and the measured current. For the power demand loop, the error is the difference between the set point and the user-selected feedback. See *Feedback* below.

The two loops use proportional and integral (PI) control which allows them to compensate for both transient and long-term variations in conditions, including line voltage and load resistance. The performance of each loop can be tuned by adjusting the corresponding proportional band and time integral settings. The Prop Band Power and Integral Power parameters determine how the power controller adjusts its output to match the set point. The Prop Band Current and Integral Current parameters determine how the power controller adjusts the output to ensure that the current limit set point is enforced. These parameters are on the advanced setup menu.

The power demand set point can be set with the Set Point parameter on the Operator menu via the keypad or via communications. Alternatively it can be set by an analog voltage or current signal from a potentiometer or another piece of automation equipment such as a temperature controller.

DT2 Models

Three-phase, two-leg models use one control loop to regulate power to the load. The power demand loop attempts to drive the output to match the power demand set point.

The loop adjusts its output based on its measurement of error, the difference between the set point and the measured and calculated feedback. See *Feedback* below.

The power demand loop uses proportional and integral (PI) control which allows it to compensate for both transient and long term variations in conditions, including line voltage and load resistance. The performance of this loop can be tuned by adjusting the proportional band and time integral settings. The Prop Band Power and Integral Power parameters determine how the power controller adjusts its output to match the set point. These parameters are on the advanced setup menu.

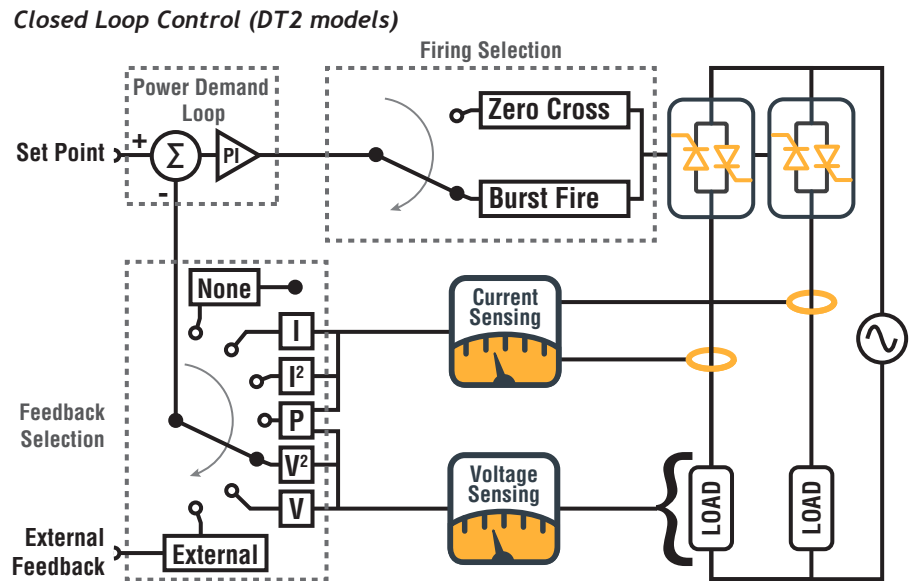

The power demand set point can be set with the Set Point parameter on the Operator menu via the keypad or via communications. Alternatively it can be set by an analog voltage or current signal from a potentiometer or another piece of automation equipment such as a temperature controller.

Feedback

The feedback setting determines what the power controller attempts to keep constant and therefore what variations are minimized.

Because closed-loop control reacts to the difference between the user-supplied set point and the measured feedback, the feedback selection also determines the meaning of the set point. For example, if Feedback is set to Voltage, the set point is interpreted as a percentage of the nominal load voltage. In that case, with set point at 50%, the power controller adjusts the output to make the voltage drop across the load half the Nominal V setting.

These options are available for feedback:

- **Voltage**—the power controller adjusts the output to make the measured load voltage divided by the nominal load voltage equal to the set point. This method of control compensates for line voltage fluctuations; the power remains constant as long as the load impedance does not change.

$$\text{Feedback} = \left(\frac{V_{rms}}{V_{nominal}} \right) 100\% \quad \text{Set Point is a percentage of } V_{nominal}$$

- **Voltage Squared**—the power controller adjusts the output to make the square of the measured load voltage divided by the square of the nominal load voltage equal to the set point. The output power responds linearly to changes in the set point for loads with constant resistance. This method of control compensates for line voltage fluctuations; the power remains constant as long as the load impedance does not change.

$$\text{Feedback} = \left(\frac{V_{rms}}{V_{nominal}} \right)^2 100\% \quad \text{Set Point is a percentage of } V_{nominal}^2$$

- **Power**—the power controller adjusts the output to make the product of the measured load current and voltage divided by the product of the nominal load voltage and nominal load current equal to the set point. With this method of control the power remains constant even when the line voltage or load impedance varies.

$$\text{Feedback} = \left(\frac{V_{rms} I_{rms}}{V_{nominal} I_{nominal}} \right) 100\% \quad \text{1 Phase} \quad \text{OR} \quad \left(\frac{V_{rms} (I_{1rms} + I_{2rms})}{2 V_{nominal} I_{nominal}} \right) 100\% \quad \text{2 Leg, 3 Phase} \quad \text{OR} \quad \left(\frac{V_{rms} (I_{1rms} + I_{2rms} + I_{3rms})}{3 V_{nominal} I_{nominal}} \right) 100\% \quad \text{3 Leg, 3 Phase}$$

Set Point is a percentage of $V_{nominal} \times I_{nominal}$

- **Current Squared**—the power controller adjusts the output to make the square of the measured load current divided by the square of the nominal load current equal to the set point. The set point is a percentage of the square of the nominal load current. With this method of control the power remains constant as long as the load impedance does not change.

$$\text{Feedback} = \left(\frac{I_{rms}}{I_{nominal}} \right)^2 100\% \quad \text{1 Phase} \quad \text{OR} \quad \left(\frac{I_{1rms} + I_{2rms}}{2 I_{nominal}} \right)^2 100\% \quad \text{2 Leg, 3 Phase} \quad \text{OR} \quad \left(\frac{I_{1rms} + I_{2rms} + I_{3rms}}{3 I_{nominal}} \right)^2 100\% \quad \text{3 Leg, 3 Phase}$$

Set Point is a percentage of $I_{nominal}^2$

- **Current**—the power controller adjusts the output to make the measured load current divided by the nominal load current equal to the set point. This method of control maintains constant current even when the line voltage or load impedance varies.

$$\text{Feedback} = \left(\frac{I_{rms}}{I_{nominal}} \right) 100\% \quad \text{1 Phase} \quad \text{OR} \quad \left(\frac{I_{1rms} + I_{2rms}}{2 I_{nominal}} \right) 100\% \quad \text{2 Leg, 3 Phase} \quad \text{OR} \quad \left(\frac{I_{1rms} + I_{2rms} + I_{3rms}}{3 I_{nominal}} \right) 100\% \quad \text{3 Leg, 3 Phase}$$

Set Point is a percentage of $I_{nominal}$

- **External**—the power controller adjusts the output to make the signal received as external feedback on analog input 2 equal to the set point.
- **No Feedback**—the power controller output is on for a percentage of time equal to the set point. The power demand loop does not adjust the output based on the measured voltage or current.

Keep in mind that in single-phase and 60A to 500A three-phase models, the output is limited by the current limit loop. Therefore, at times the actual output may be less than the power demand loop's set point. See "Current Limit" on page 74.

Set the feedback on the advanced setup menu see "Feedback" on page 58. The feedback can also be set with a digital input. See "Digital Inputs" on page 74.

Current Limit

For models that include current limiting, this feature is always active. By default it limits the RMS load current by reducing the output whenever the power demand control loop would tend to drive current above the current limit set point.

You can configure the power controller to limit peak rather than RMS current. The controller limits peak current by switching to phase angle firing whenever the peak current would otherwise exceed the limit. When peak current limiting is enabled, the current limit set point is interpreted as peak rather than RMS current. See “Limit Peak Current (Models with Current Limit)” on page 61.

Set the current limit set point, I_{Limit} , on the setup menu. To determine the current limit set point empirically, see “Configure the Current Limit” on page 33.

Configurable Inputs and Outputs

The ASPYRE power controller features two digital inputs, up to two analog inputs and a relay output. Some models also include an analog output for retransmitting a measured value to other automation equipment. This section describes the various functions of these inputs and outputs and how they interact with other features of the power controller.

Digital Inputs

The ASPYRE power controller has two optically-isolated, digital inputs that can be connected to control panel switches or other automation equipment such as a temperature controller or programmable logic controller. See “Configurable Digital Inputs (Digital Input 1 and Digital Input 2)” on page 27 for information on connecting to the digital inputs.

Using *Digital In 1 Function* and *Digital In 2 Function* on the hardware menu each digital input can be configured to perform one of the following:

- **Enable**—the power output is off unless this signal is on. If both digital inputs are set to this option, the state of digital input 2 takes precedence.
- **Voltage Feedback**—this signal overrides the feedback setting. When this signal is on, the control loop uses voltage feedback. When the signal is off, the loop reverts to the feedback parameter setting.
- **Local / Remote**—this signal selects how the set point is set. When this signal is on, the control loop’s set point is set using the keypad or through communications. When this signal is off, the set point is set by the an analog input. When a digital input is set to this function, the Local/Remote (L/R) button on the front panel cannot be used to choose the source of the set point.
- **Phase Angle**—this signal overrides the *Firing* setting. When this signal is on, the power controller uses phase-angle firing. When the signal is off, the controller uses the method set with the firing parameter on the advanced setup menu. This option is available with single-phase and 60A to 500A three-phase models.
- **SP Analog In 1 / 2**—this signal chooses which of the two analog inputs is used as the source of the set point when the remote set point is in effect. When this signal is off, analog input 1 is the source of the remote set point. When the signal is on, analog input 2 is the source of the remote set point.
- **Logging**—this signal turns data logging on or off. When the signal is on, data is logged. When the signal is off, data is not logged. When this signal is on, it supersedes the setting of the *Logging parameter* on the advanced setup menu.
- **Heater Bakeout**—this signal turns the heater bakeout feature on or off. When the signal is on, the heater bakeout feature is enabled. When the signal is off, the heater bakeout feature is disabled. When this signal is on, it supersedes the setting of the *Heater Bakeout* parameter on the advanced setup menu. This option is available with single-phase and 60A to 500A three-phase models.

To configure how the power controller uses these signals, see “Digital In 1 Function” on page 56 and “Digital In 2 Function” on page 57.

Analog Input 1: Set Point

To control the power to the load with a device such as a temperature controller, connect the control signal to analog input 1.

This input accepts current, voltage and potentiometer signals. The signal is interpreted as set point by comparing the measured value to the input's full scale. For example, the set point is 50% when the analog input detects 5V and the input is configured to receive 0 to 10VDC.

Configure the power controller to recognize the signal with the hardware menu; see "Analog In 1 [Signal Type]" on page 53. For instructions for wiring this input see "Set Point (Analog Input 1)" on page 26.

Analog Input 2: Set Point, Feedback or Current Limit Set Point

What this input does is user-configurable. Connect an analog signal that indicates:

- An alternate set point signal
- Measured power, voltage or current from an external device used as feedback
- Maximum current to the load (current limit) in single-phase and 60A to 500A three-phase models

This input accepts current, voltage and potentiometer signals. The signal is interpreted by comparing its measured value to the input's full scale. For example, the signal is 50% when the analog input detects 12mADC and the input is configured to receive 4 to 20mADC.

Configure the power controller to recognize the signal and how the power controller uses it on the hardware menu; see "Analog In 2 [Signal Type]" on page 54 and "Analog In 2 Function" on page 54. For instructions for wiring this input see "Set Point, Feedback or Current Limit (Analog Input 2)" on page 26.

Alarms and Alarm Relay Output

When an alarm occurs and while the condition persists, the alarm relay is de-energized. The alarm relay is energized when power is supplied to the controller's electronics via the auxiliary power input and there are no alarms.

Choose which conditions determine the alarm relay output with the *Alarm Function* setting on the hardware menu. See "Alarm Function" on page 53.

⚠ NOTE! The alarm relay output indicates an alarm whenever the temperature of the heat sink is too high even when Alarm Function on the hardware menu is set to None.

⚠ NOTE! The power controller monitors for heater break or short circuit conditions only when included in the option selected for Alarm Function.

Alarm Function Options

	Alarm Output Energizes for...				
	Heater Break	Shorted SCR	Current Limit	Communication Watchdog Error	Heat Sink Over Temperature
None					X
Heater Break (HB)	X				X
SCR Short (SC)		X			X
I Limit (IL)*			X		X
Hb / SC	X	X			X
Hb / IL*	X		X		X
SC / IL*		X	X		X
HB / SC / IL*	X	X	X		X
Watchdog (WD)				X	X
WD / HB	X			X	X
WD / SC		X		X	X
WD / SC / HB	X	X		X	X
WD / IL*			X	X	X
WD / IL / HB*	X	X		X	X
WD / IL / HB*	X	X		X	X
WD / IL or SC / HB*	X	X	X	X	X

*Models with current limit

Retransmit Output

Connect the analog output to an external device so the external device can monitor or record set point, current, voltage or actual power.

Which parameter is retransmitted and the scaling of the output are user-configurable on the hardware menu; see “Retransmit (Models with Retransmit)” on page 65, “Retransmit Type (Models with Retransmit)” on page 66 and “Retransmit Scale (Models with Retransmit)” on page 66.

Firing Types

This section describes the options for the *Firing* parameter. Using the correct firing ensures the optimum performance of the power controller with a particular type of load. Set *Firing* on the advanced setup menu.

Zero-Crossing

This firing type is used with relatively slow loads and when it is desirable to minimizing radio frequency emissions by switching only as the line voltage crosses zero volts. Power to the load is on for a percentage of the fixed time-base proportional to the required output percentage. The time base is defined by the *Cycle Time* parameter. For example, if the cycle time is ten seconds and 75% power is called for, the output turns on for 7.5 seconds and off for 2.5 seconds, and repeats.

The illustration shows examples of zero-cross firing with a cycle time of 10 seconds:

- 25%, the output is on for 2.5 out of every 10 seconds (150 out of 600 cycles at 60Hz)
- 50%, the output is on for 5 out of every 10 seconds (300 out of 600 cycles at 60Hz)
- 75%, the output is on for 7.5 out of every 10 seconds (450 out of 600 cycles at 60Hz)
- 100%, the output is on continuously

Zero-Cross Firing Examples

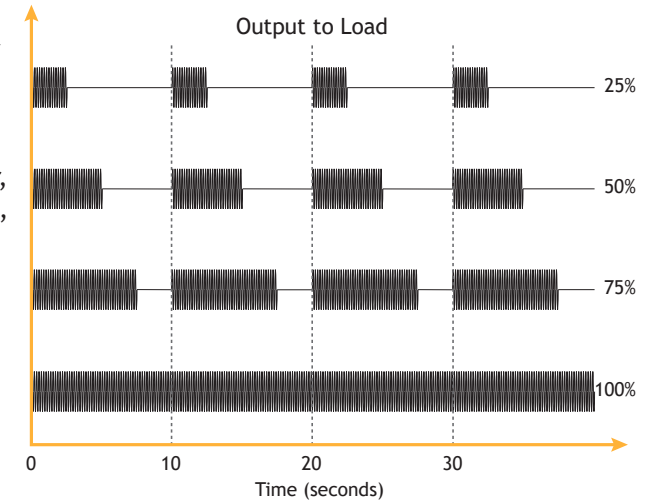

Zero-Crossing Settings

In order to operate the power controller with zero-cross firing, set the following parameters as indicated.

Menu	Parameter	Setting
Adv Setup	Feedback	As desired
	Firing	Zero Cross
Set Point:		
Hardware	Analog In 1	According to the connected signal
OR		
Operator	Set Point	As desired

Contactor Operation

The power controller can be configured to switch power on and off following a signal from, for example, a temperature controller's output. In this case, power to the load is on when the signal from the temperature controller to the power controller's digital input is high, and off when the signal is low. The power controller is said to operate as a contactor. When controlled by a device such as a temperature controller, any time proportioning is determined by that device, not the power controller. In this configuration the power controller's power demand loop does not adjust the output or use feedback, but in single-phase and 60A to 500A three-phase models the current limiting loop is active and will reduce power delivered to ensure current does not exceed the limit.

Contactor Operation Example

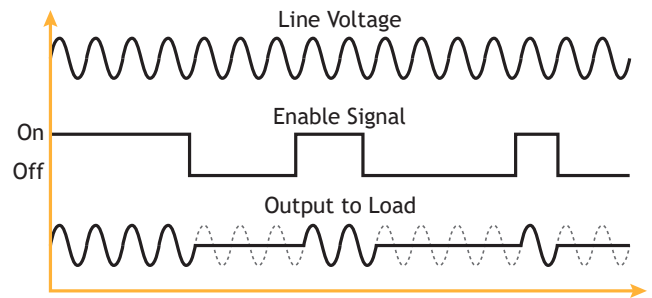

Though the output is said to follow the enable input, power to the load is actually switched on or off only at the voltage zero cross in order to minimize radio frequency emissions.

Contactor Operation Settings

In order to operate the power controller as a contactor, set the following parameters as indicated.

Menu	Parameter	Setting
Adv Setup	Feedback	No feedback
	Firing	Zero Cross
Hardware	Digital In 1 Function	Enable
Operator	Set Point	100%

Single Cycle (DT1 Models)

Use this firing type when it is desirable for the power to the load to switch on and off as frequently as every ac line cycle while still minimizing radio frequency emissions by switching only as the line voltage crosses zero volts.

With single-cycle firing, power to the load is on for a number of cycles proportional to the required output percentage.

The illustration shows examples of single-cycle firing:

- 25%, the output is on for one out of every four cycles
- 50%, the output is on one out every two cycles
- 75%, the output is on for three out of every four cycles
- 100%, the output is on continuously

Single-Cycle Firing Examples

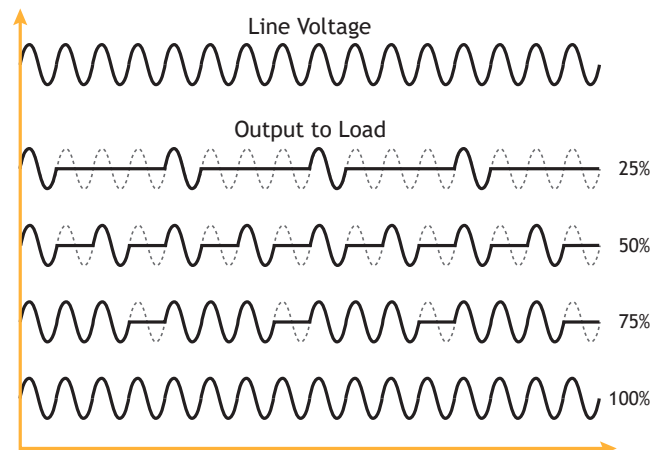

Single-Cycle Settings

In order to operate the power controller using single-cycle firing, set the following parameters as indicated.

Menu	Parameter	Setting
Adv Setup	Feedback	As desired
	Firing	Single Cycle
Set Point:		
Hardware	Analog In 1	According to the connected signal
OR		
Operator	Set Point	As desired

Burst Firing

Use this firing type when it is desirable for the power to the load to switch on and off frequently but not as frequently as every ac line cycle. Burst firing minimizes radio frequency emissions by switching only as the line voltage crosses zero.

With burst firing, power to the load is on for a number cycles proportional to the required output percentage.

Burst firing is similar to single-cycle firing, but the output is on and off for a minimum number of cycles specified by the user with the *Min Cycles* setting on the advanced setup menu.

The illustration shows examples of burst firing with four minimum cycles:

- 25%, the output is on for four out of every sixteen cycles
- 50%, the output is on for four out every eight cycles
- 75%, the output is on for twelve out of every sixteen cycles
- 100%, the output is on continuously

Burst Firing Examples

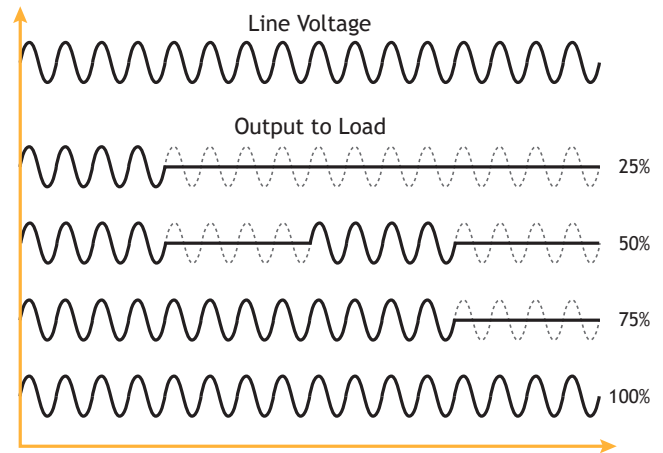

Burst Firing Settings

In order to operate the power controller using burst firing, set the following parameters as indicated.

Menu	Parameter	Setting
Adv Setup	Feedback	As desired
	Firing	Burst Fire
	Min Cycles	As desired
Set Point:		
Hardware	Analog In 1	According to the connected signal
OR		
Operator	Set Point	As desired

Burst Firing with Start Ramp (DT1 and DT3 Models)

This firing type is similar to burst firing, however, the addition of the start ramp feature causes the output to be phase-angle fired for a user-specified number of half cycles at the beginning of each burst. This intermittent phase-angle firing increases radio frequency emissions compared with purely zero-cross switching firing types. This firing type is recommended for use with small inductive loads to avoid inrush current.

The illustration shows examples of burst firing with four minimum cycles and a six half-cycle start ramp:

- 25%, the output ramps up for three and is on for one full cycle out of every sixteen
- 50%, the output ramps up for three and is on for one full cycle out of every eight
- 75%, the output ramps up for three and is on for nine full cycles out of every sixteen
- 100%, the output ramps up for three cycles and then is on continuously

Burst Firing with Start Ramp Examples

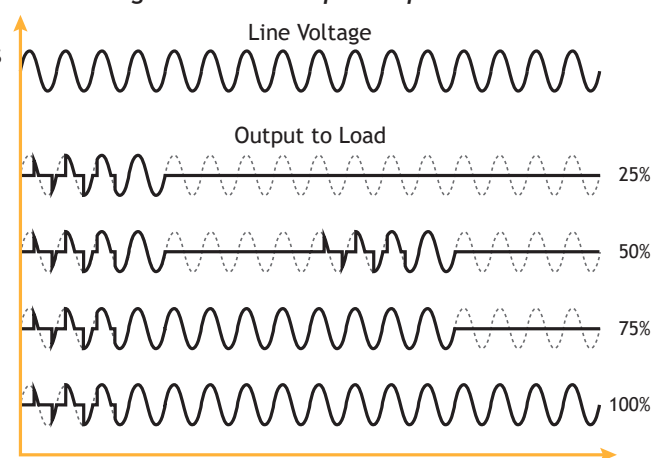

Burst firing is similar to single-cycle firing, the load switches on for a number cycles proportional to the required output percentage, but the output is on and off for a minimum number of cycles specified by the user on the advanced setup menu with the *Minimum Cycles* setting.

Burst Firing with Start Ramp Settings

In order to operate the power controller using burst firing with Start Ramp, set the following parameters as indicated.

Menu	Parameter	Setting
Adv Setup	Feedback	As desired
	Firing	Burst Fire Start Ramp
	Min Cycles	As desired
	Start Ramp	As desired
Set Point:		
Hardware	Analog In 1	According connected signal
OR		
Operator	Set Point	As desired

Burst Firing with Delayed Triggering (DT1 and DT3 Models)

This firing type is similar to burst firing except that it turns on at a user-specified firing angle at the beginning of each burst.

Delaying the firing angle is recommended when switching the primary of a transformer coupled to a load with stable resistance on the secondary. Zero-cross switching of inductive loads such as transformer-coupled heaters can generate transient over currents that can blow fuses. By delaying the point the output is switched on to the point at which the current will be zero rather than when relative to when the voltage crosses zero, minimizes these adverse effects.

The illustration shows examples of burst firing with two minimum cycles and a delay of 50 degrees applied to one half-cycle:

- 25%, the output turns on at 50° and remains on for the remainder of two out of every eight cycles
- 50%, the output turns on at 50° and remains on for the remainder of two out of every four cycles
- 66%, the output turns on at 50° and remains on for the remainder of two out of every three cycles
- 100%, the output turns on at 50° and remains on continuously

Burst Firing with Delay Triggering Examples

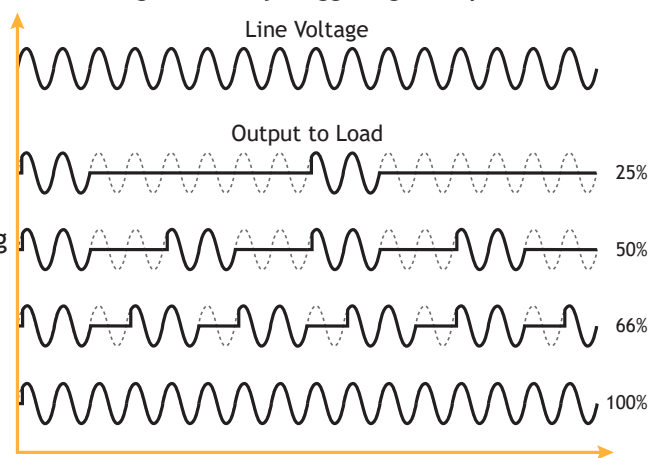

⚠️ NOTE! Do not use this firing type with transformer-coupled loads that have low resistances when cold, such as heaters with silicon carbide, molybdenum and tungsten elements. Instead consider using phase-angle firing.

Delayed triggering increases radio frequency emissions compared with purely zero-cross switching firing types.

Other than the programmable delay, this firing method is similar to burst firing. The load switches on for a number cycles proportional to the required output percentage. The output is on and off for at least the user-specified number of cycles.

The illustrations below contrast burst firing with and without the switching delay.

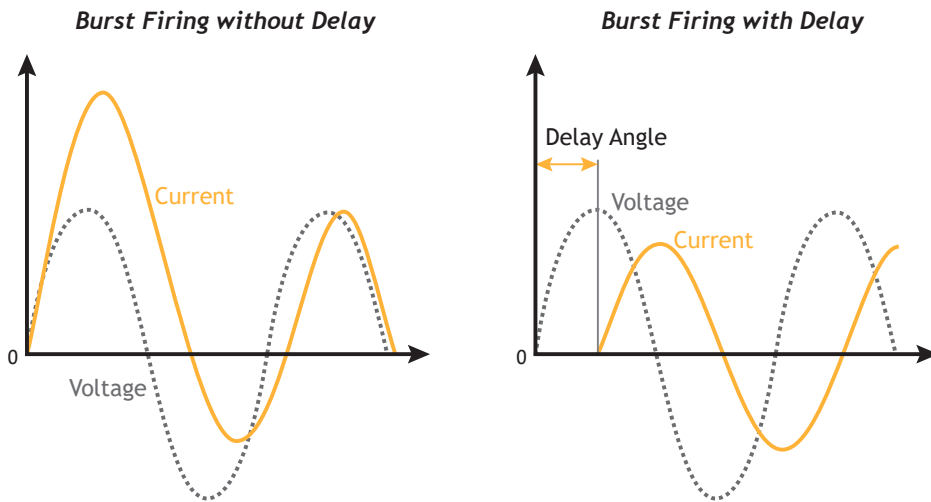

The ideal delay angle is the delay necessary to switch when the current is zero. This angle depends on the power factor. The delay angle suggested for most applications is 80°.

Burst-Firing-with-Delay Settings

In order to operate the power controller using burst firing with delay, set the following parameters as indicated.

Menu	Parameter	Setting
Adv Setup	Feedback	As desired
	Firing	Burst Fire Delay Trigger
	Min Cycles	As desired
	Delay	As desired
	Half Cycles to Delay	As desired
Set Point:		
Hardware	Analog In 1	According to the connected signal
OR		
Operator	Set Point	As desired

Half Cycle (DT1 Models)

Use this firing type when faster switching than single-cycle firing is desired to reduce power fluctuations while maintaining the minimized radio frequency emissions of zero-cross switching. Rather than switching every line cycle, the power can be switched every half cycle. Positive and negative cycles are balanced to prevent DC bias. This firing type is recommended for shortwave infrared lamps.

The load switches on for a number half-cycles proportional to the required output percentage.

The illustration shows examples of half-cycle firing:

- 25%, the output turns on for one half cycle out of every one and a half cycles
- 50%, the output turns on for one half cycle out of every cycle
- 66%, the output turns on for two half cycles out of every one and a half cycles
- 100%, the output is on continuously

Half Cycle Firing Examples

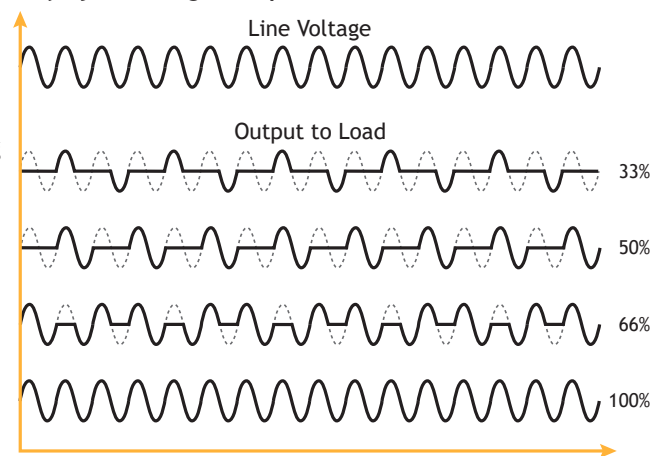

Half Cycle Firing Settings

In order to operate the power controller using half-cycle firing, set the following parameters as indicated.

Menu	Parameter	Setting
Adv Setup	Feedback	As desired
	Firing	Half Cycle
Set Point:		
Hardware	Analog In 1	According to the connected signal
OR		
Operator	Set Point	As desired

Phase Angle (DT1 and DT3 Models)

This firing type is recommended for controlling inductive loads including the primary of transformer-coupled load and for loads with low resistances when cold such as heaters with silicon carbide, molybdenum and tungsten elements. The disadvantage is increased radio frequency emissions compared with zero-cross firing types.

The load switches on for a portion of each half line cycle. This limits the voltage applied across the load when the power is less than 50%.

The illustration shows examples of phase-angle firing:

- 25%, the output is on for a quarter of each half cycle (on at 135° , off at 180° , on at 315° , off at 360°)
- 50%, the output is on for one half of each half cycle (on at 90° , off at 180° , on at 270° , off at 360°)
- 75%, the output is on for three quarters of each half cycle (on at 45° , off at 180° , on at 225° , off at 360°)
- 100%, the output is on continuously

Phase-Angle Firing Examples

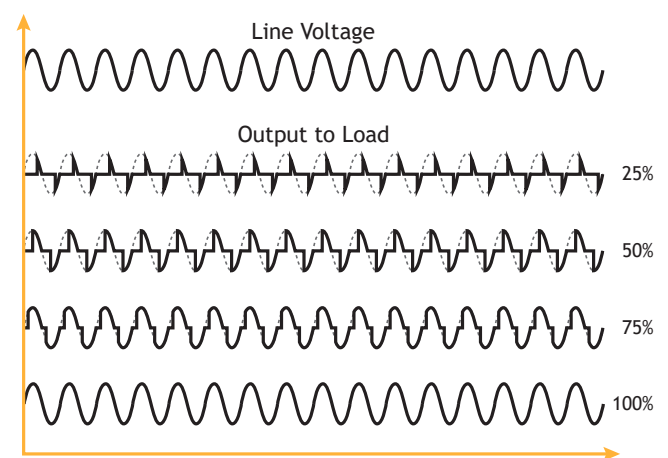

Phase-Angle Firing Settings

In order to operate the power controller using phase-angle firing, set the following parameters as indicated.

Menu	Parameter	Setting
Adv Setup	Feedback	As desired
	Firing	Phase Angle
Set Point:		
Hardware	Analog In 1	According to the connected signal
OR		
Operator	Set Point	As desired

NOTE! When the firing type is set to *Phase Angle*, the soft start feature is ignored. To use soft start with phase angle, set the firing type to *Phase Angle with Soft Start*.

Phase Angle with Soft Start (DT1 and DT3 Models)

This firing type is the same as *Phase Angle* except it does use the soft start feature. Whenever the set point is changed, the firing angle is gradually adjusted rather than being instantaneously changed. The set point is ramped from the previous set point to the new set point over the user-set Soft Start Time which is set in 50ms increments on the advanced setup menu.

The soft start feature also applies when the enable signal turns on. For example if the set point is 60% but the enable signal is off, when the enable signal turns on, the output gradually increases as if the set point was ramped up from 0% to 60% over the soft start time. However, when the enable signal turns off, unlike the case of lowering the set point, the output turns off immediately rather than ramping down.

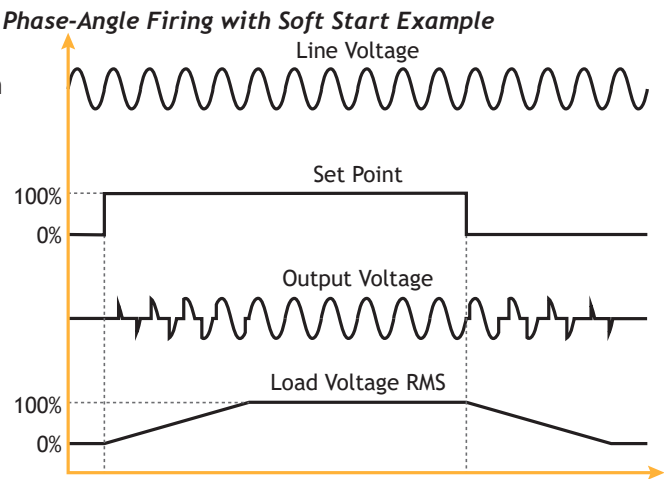

This firing type is recommended to reduce inrush current with transformers during the cycle of magnetization or with cold resistance loads that are nearly short circuits when they are first turned on.

Phase Angle with Soft Start Settings

In order to operate the power controller using phase-angle firing with soft start, set the following parameters as indicated.

Menu	Parameter	Setting
Adv Setup	Feedback	As desired
	Firing	Phase Angle Soft Start
	Soft Start Time	As desired
Set Point:		
Hardware	Analog In 1	According to the connected signal
OR		
Operator	Set Point	As desired

Soft Start

The soft start feature can be used with all firing types except *Phase Angle*. Soft start acts as a filter on the set point gradually applying changes to the set point over the user-set soft start time. The soft start time is set in 50ms increments on the advanced setup menu.

The soft start feature also applies when the enable signal changes state. For example, if the set point is 60% but the enable signal is off, when the enable signal turns on, the output gradually increases as if the set point was ramped up from 0% to 60% over the soft start time setting.

⚠️ NOTE! When the firing type is set to *Phase Angle*, the soft start feature is ignored. To use soft start with phase angle, set the firing type to *Phase Angle Soft Start*.

Start Ramp (DT1 and DT3 Models)

Start ramp causes the output to be phase-angle fired for a user-specified number of half cycles each time the output is turned on. This intermittent phase-angle firing increases radio frequency emissions compared with purely zero-cross firing types. Set the duration of the ramp using the *Start Ramp* parameter on the advanced set-up menu in increments of half cycles.

Safety Ramp (DT1 and DT3 Models)

This feature is the same as start ramp except it is active only if the output is off for longer than a user-set time. Safety ramp can be used with single-phase and 60A to 500A three-phase models using burst firing with delay or half cycle firing. Use it to ramp up the voltage applied to a heater or other load which has been off for more than a user set time.

With this option enabled, after power to the load has been off for more than the user-set time, once power is called for, the firing type is temporarily changed to phase angle and the power is ramped up from zero to the set point over the safety ramp time. Once the ramp is complete, the firing type reverts to the user setting.

Because it uses phase-angle firing, safety ramp increases radio frequency emissions when active compared with purely zero-cross switching.

Enable the safety ramp feature and set how long the ramp takes by setting the *Safety Ramp Duration* (#66) to a value greater than zero (in increments of 50ms). Set the minimum amount of time the power to the load is off before the ramp occurs with the *Safety Ramp Off Time* parameter in increments of 50ms (#65).

Heater Bakeout Function (Models with Current Limit)

When a heater insulated with magnesium oxide (MgO) is powered off, not in use or in storage for a long period of time, it can absorb moisture. If full power is applied, excessive current can damage the heater or blow fuses. The heater bakeout feature limits the voltage and current applied as the heater is brought back in to service. This drives moisture out of the heater and prevents blown fuses and damage to the heater.

Using Heater Bakeout

While the heater bakeout feature is active, the ASPYRE power controller ramps the current according to the user-set current and ramp time parameters for the heater bakeout function. The heater bakeout function does not ramp the output above the normal process set point. Once the function has run for the user-set time, the bakeout function terminates and the power controller attempts to perform control to set point normally.

Use Heater Bakeout Ramp Time to set the duration of the bakeout in minutes. Use Heater Bakeout Current to set the current to which the function attempts to ramp in Amperes. Use Heater Bakeout Off Time to set how many minutes the heater can be off before the bakeout function runs the next time the heater is used.

While performing the heater bakeout function, the power controller displays a message.

Heater Bakeout Indication



Totalizer

The ASPYRE power controller includes a power totalizer that sums the power over time in various terms. The total power over time can be viewed on the ASPYRE Configurator PC software's Test view.

Totalizer Function in ASPYRE Configurator

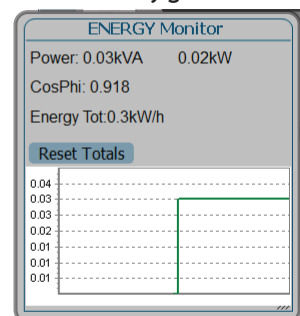

Data Logging

The ASPYRE power controller offers an optional data logging feature. Record up to ten parameters as often as once per second. Use ASPYRE Configurator software to set the real-time clock, to select which parameters to log, to retrieve data log files and to manage the logging memory. See “Setting Up and Using Data Logging” on page 42. The ASPYRE Configurator software also supports viewing the data in log files after downloading them from the power controller.

Data logging can be turned on and off using:

- ASPYRE Configurator software (see “Setting Up and Using Data Logging” on page 42.)
- The advanced setup menu in the power controller’s user interface (see “Logging” on page 61)
- A digital input (see “Digital In 1 Function” on page 56, “Digital In 2 Function” on page 57 and “Digital Inputs” on page 74)

9

Maintenance & Troubleshooting

This chapter describes the routine maintenance that should be planned, provides information for troubleshooting and includes procedures for corrective actions.

!NOTE! To ensure proper and safe operation of the equipment all investigation, adjustments and replacement procedures must be performed by qualified individuals.

!REMARQUE : Pour assurer un fonctionnement approprié et sécuritaire de l'équipement, toutes les recherches, les réglages et les procédures de remplacement doivent être effectués par le personnel qualifié.

Routine Maintenance

With very little maintenance you can expect the ASPYRE power controller to provide years of trouble-free operation.

1. To prevent overheating, periodically clean the heat-sink and protective grill on the fans. Depending on the environment, this cleaning may be necessary more or less frequently.
2. Periodically verify the torque on the bolts for the line, power and safety earth ground connections.

Alarms and Indicators

This section describes the alarms that can occur and what can cause them.

Alarm Indicator

When an alarm occurs and while the condition persists, the indicator labeled "4" on the display is lit. The indicator is normally off.



Alarm Relay Output

When an alarm occurs and while the condition persists, the alarm relay is de-energized. The alarm relay is energized when power is supplied to the controller's electronics via the auxiliary power input and there are no alarms. The alarm relay can be configured to indicate various combinations of alarms using the hardware menu see "Alarm Function" on page 53.

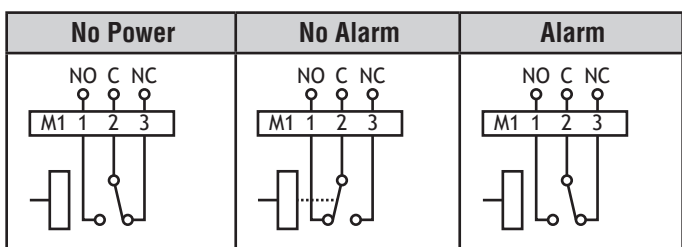

Alarms and Messages

The display normally indicates the power demand set point and one of the home page parameters such as output current. When an alarm or other condition occurs and while the condition persists, the upper display flashes the corresponding message. See the table below and the following sections for descriptions of each.

Alarms and Messages

Alarm or Message	DT1	DT2	DT3	Description
Aux High	X	X	X	Aux voltage too high
Aux Line Loss	X	X	X	Auxiliary power is not detected
Aux Low	X	X	X	Aux voltage too low
Bakeout	X		X	Heater bakeout function is active
Heater Break	X	X	X	Heater break alarm
I Limit	X		X	Output reduced by current limit feature
PH Loss		X	X	One or more phases of the line power are disconnected
SD Card Error	X	X	X	SD card error
SCR Short	X	X	X	Shorted SCR (output on continuously)
SCR Over Temp	X	X	X	Thermal switch over temperature
Unbalance Load		X	X	One or more legs of the load are open
Watchdog	X	X	X	Communication watchdog error

Aux High

This alarm occurs when the auxiliary voltage is over the maximum required. Verify the auxiliary power requirement per the model number.

Aux Line Loss

This alarm is indicated when the line power is off, but the electronics are powered by another means, such as the USB port or the optional 24VDC input.

Aux Low

This alarm occurs when the auxiliary voltage is below the minimum required. Verify the auxiliary power requirement per the model number.

Bakeout

The heater bakeout feature is controlling the output. See "Heater Bakeout Function (Models with Current Limit)" on page 83.

Heater Break Alarm

This alarm occurs when the measured load resistance is higher than expected. See "Heater Break Calibration Procedure" on page 90.

I Limit

In models with the current limit option this alarm indicates when the current loop overrides the power demand loop to prevent the load current from exceeding the current limit set point. In DT3 models this alarm indicates when the current exceeds the user-set current limit. DT1 and DT3 models reduce the output to enforce the limit; DT2 models do not. For more information see "Current Limit" on page 74.

PH Loss

One or more phases of the line power are disconnected.

SD Card Error

This error occurs when the SD memory card option is present but does not work properly or when it is impossible to read or write data. Contact your supplier.

SCR Short

This alarm occurs when the SCR is stuck on and the output is on continuously.

Thermal Switch

This alarm occurs when the temperature sensor on the power switch indicates it is too hot. The thermal switch alarm triggers the alarm relay output. Until the temperature is reduced, power to the load is turned off. Correct the environmental conditions that caused the over temperature or reduce the load current to resume operation. Operating the unit at temperatures outside the specified range can void the warranty. For information on proper cooling see "Cooling Requirements" on page 18.

Unbalanced Load

The resistance of one or more legs of the load has gone outside the tolerance for a balanced load. The alarm indication specifies which leg of the load is outside the tolerance. This likely indicates one or more legs of the load are open.

Watchdog

This error occurs when the communications watchdog feature is enabled but no transmission has been received for longer than the user-set watchdog reset time. When this error occurs, power to the load is turned off. See "Watchdog" on page 69 and "Watchdog Reset Time" on page 69.

Removing the Covers

 **WARNING:** To prevent injury and loss of life, shut off power and ensure it cannot be restored while performing work with the covers open or removed.

 **CAUTION:** Take appropriate precautions to prevent electrostatic discharges from damaging electronic components when handling the boards.

 **AVERTISSEMENT :** Pour éviter les blessures et les pertes de vie, couper l'alimentation électrique et s'assurer qu'elle ne peut être restaurée pendant l'exécution du travail avec les couvercles ouverts ou enlevés.

 **ATTENTION :** Prendre les précautions appropriées pour empêcher que les décharges électrostatiques n'endommagent les composants électroniques au moment de la manipulation des cartes de circuits.

To remove the top cover (line power) or bottom cover (load connections):

1. Loosen and remove the fasteners (1 ea. single-phase, 2 ea. 3-phase).
2. Tilt the cover toward you and remove it.
3. After removing the top and bottom covers, tilt the center cover forward.



Replacement Fuses

The ASPYRE power controller contains fast-blow fuses protecting the SCR power switches. These fuses are critical to safe operation of the power controller particularly in preventing catastrophic failure in the event of a shorted load. The agency approvals are contingent upon the use of the same fuses (manufacturer and model) that were tested. The table below lists the tested and approved fuses for the various models.

⚠ CAUTION: These fuses protect life and property against catastrophic failure in the event of a shorted load. They do not provide and are not approved for branch circuit protection.

⚠ CAUTION: The power controller warranty is void if the tested and approved fuses are not used.

⚠ WARNING: Before opening the cover, disconnect and lock out the line power and control signals to the unit and verify that power and control cables are isolated from voltage sources.

⚠ ATTENTION : Ces fusibles protègent la vie et la propriété contre des pannes catastrophiques en cas de charge en court-circuit. Ils n'assurent aucune protection des circuits de dérivation et ne sont pas approuvés à cette fin.

⚠ ATTENTION : La garantie du régulateur de puissance est nulle si aucun fusible testé et approuvé n'est utilisé.

⚠ AVERTISSEMENT : Avant d'ouvrir le couvercle, débrancher et verrouiller les signaux d'alimentation de ligne et de commande, puis vérifier que les câbles d'alimentation et de commande sont isolés des sources de tension.

Replacement Fuses

ASPYRE Model	Qty.	Fuse Part Numbers		
		Watlow	Cooper Bussman®	Siba
DT1__-300...	1	0808-0362-0000	350FM	
DT1__-400...	1	0808-0358-0000	550FMM	
DT1__-500...	1	0808-0359-0000	700FMM	
DT1__-600...	4	0808-0363-0250		20 559 20.250
DT1__-700...	4			
DT248-300...	3	0808-0357-0000	450FMM	
DT260-300...	3			
DT269-300...	3	2055-5072	400FMM	
DT2__-400...	3	0808-0358-0000	550FMM	
DT2__-450...	6	0808-0360-0000	315FM	
DT2__-500...	6			
DT2__-600...	4	0808-0357-0000	450FMM	
DT2__-700...	4			
DT348-300...	3			
DT360-300...	3	2055-5072	400FMM	
DT369-300...	3			
DT3__-350...	3	0808-0358-0000	550FMM	
DT3__-400...	3			
DT3__-450...	3	0808-0359-0000	700FMM	
DT3__-500...	3			

Replacement Fuse Torque

Replacement Fuse Torque	221.3 in.-lb. (25 Nm)
-------------------------	-----------------------

Replacing the Battery

The real time clock option includes a battery so that the time and date settings and the clock function persist when line power is shut off. The battery is expected to provide years of service, but must be replaced when the clock fails to keep time when the power is off.

 **WARNING:** Before opening the cover, disconnect and lock out the line power and control signals to the unit and verify that power and control cables are isolated from voltage sources.

 **CAUTION:** Take appropriate precautions to prevent electrostatic discharges from damaging electronic components when handling the boards.

 **NOTE!** Dispose of the battery properly.

 **REMARQUE :** Éliminer la batterie de manière appropriée.

 **AVERTISSEMENT :** Avant d'ouvrir le couvercle, débrancher et verrouiller les signaux d'alimentation de ligne et de commande, puis vérifier que les câbles d'alimentation et de commande sont isolés des sources de tension.

 **ATTENTION :** Prendre les précautions appropriées pour empêcher que les décharges électrostatiques n'endommagent les composants électroniques au moment de la manipulation des cartes de circuits.

To replace the battery:

1. Shut off the line power and auxiliary power to the power controller.
2. Remove the top and bottom covers and tilt the center cover forward to access the electronics.
3. Disconnect the smaller microprocessor board from the larger board by pulling straight up.
4. Replace the battery on the bottom of the microprocessor board.
5. Re-connect the microprocessor board to the larger board carefully aligning all the connector pins.
6. Replace all the covers.
7. Dispose of the battery properly.

Calibration Procedures

The procedures in this section can be used to adjust the performance of the corresponding features.

Configure the Current Limit

The current limit feature acts to prevent the RMS current from exceeding the user-set current limit. As the current approaches the limit, the power controller decreases its output. The current limit set point can be set with the I Limit parameter or by an analog input.

 **CAUTION:** This procedure must be performed only by qualified persons.

 **CAUTION:** This procedure requires turning on full power to the load. This should only be performed once the installation is complete and when it is safe to provide full power.

 **ATTENTION :** Cette procédure ne doit être effectuée que par le personnel qualifié.

 **ATTENTION** : Cette procédure nécessite la mise sous tension totale de la charge. Cela ne doit être effectué qu'une fois l'installation terminée et lorsque la puissance maximale peut être fournie en toute sécurité.

For help with entering and accessing the menus see "Menu Navigation" on page 36.

To limit the current using the parameter setting:

1. On the *Hardware* menu set *I Limit Local / Remote* to *Local*.
2. On the *Operator* menu set the *I Limit* to 0%.
3. Enable the power controller and set the power demand / set point to 100%.
4. Gradually increase the current limit set point until the RMS current is at the maximum desired value.
5. Disable the power controller.

To limit the current using the signal to analog input 2:

1. On the *Hardware* menu set *Analog In 2* for the type of signal and range:

0 to 10 VDC or 10k potentiometer	0-10 V / 10k
4 to 20 mADC	4-20mA
0 to 20 mADC	0-20mA

3. On the *Hardware* menu set the *Analog In 2 Function* to *I Limit*.
4. On the *Hardware* menu set the *I Limit Local / Remote* to *Analog In 2*.
5. Set the signal to the analog input to the minimum value (typically 0 V).
6. Enable the power controller and set the power demand / set point to 100%.
7. Gradually increase the signal to the analog input until the RMS current is at the maximum desired value.
8. Disable the power controller.

 **NOTE!** This procedure assumes the analog input signal wiring, if used has been connected and that the signal can be set to various values as needed to perform the procedure. See "Set Point (Analog Input 1)" on page 26.

Heater Break Calibration Procedure

The heater break alarm is automatically set when you set the nominal load current and nominal line voltage. If the load resistance increases due to a partial or total load failure, the heater break alarm occurs.

You can adjust the resistance threshold at which the heater break alarm occurs with the *Htr Break Sensitivity* parameter on the advanced setup menu. This parameter is set as a percent of the nominal load resistance (from 1% to 100%). A lower value causes the alarm to occur with less change to the resistance.

For example, if the nominal line voltage is 300V and the nominal load current is 3A, the nominal load resistance is 100Ω. With the heater break sensitivity set to 20%, the heater break alarm occurs if the measured load resistance rises above 120Ω.

If the heater break alarm occurs due to transient conditions, you can suppress these nuisance alarms by increasing the *Htr Break Delay* parameter.

 **CAUTION:** To work properly the load must be powered at least about 160msec.

 **NOTE!** The minimum current is 10% of the current transformer size. If the load current is below this value, the Heater Break Alarm does not work properly.

 **ATTENTION** : Pour fonctionner correctement, la charge doit être alimentée à au moins 160 m/s.

⚠️ REMARQUE : Le courant minimal est de 10 % de la taille du transformateur de courant. Si le courant de charge est inférieur à cette valeur, l’alarme de rupture du réchauffeur ne fonctionnera pas de manière appropriée.

Updating the Firmware

The firmware program that operates the ASPYRE power controller can be updated by connecting a Windows® computer via USB to the controller. Firmware updates, when available, can be found on the Watlow website.

Firmware Updates for 300A to 700A Models

Current Firmware	Upgrade DT1	Upgrade DT2 or DT3
Prior to 1.14.0	Contact Factory	Contact Factory
From 1.14.0 to 1.24.0	Version ending in .0	Version ending in .0
After 1.24.0	Version ending in .0	Version ending in .1

To update the firmware program:

1. On the Monitor menu check the current firmware Version, and on the power controller’s label check the first three characters of the part number. Then select the appropriate upgrade program file. See the table.
2. Check the power controller’s current firmware version and part number and select the appropriate upgrade program file. See the table.
3. Shut off the line power and auxiliary power to the power controller.
4. Place the Windows® computer with the firmware update file near enough to the power controller that the USB cable can connect between them.
5. Remove the top and bottom covers and tilt the center cover forward to access the electronics.
6. Locate, press and hold the boot mode button located on the underside of the smaller of the two electronics boards (see figure).
7. While holding the button, connect the USB cable (Watlow p/n 0219-0480-0000) between the power controller and the computer.
8. Release the button.
9. When Windows® displays options for the drive corresponding to the ASPYRE power controller’s internal memory, choose *Open folder to view files*.
10. Delete the file named, “firmware.bin”.
11. Copy the new file to the ASPYRE power controller’s internal memory.
12. Use the Windows® command to eject the drive corresponding to the ASPYRE power controller.
13. Disconnect the USB cable.
14. Replace the power controller’s covers.
15. Restore auxiliary and line power.
16. Wait for the update to complete before resuming normal operation.

Boot Mode Button Location

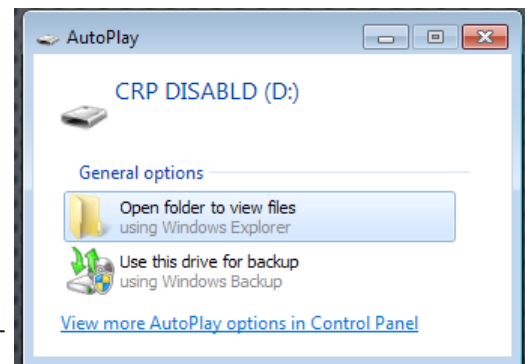
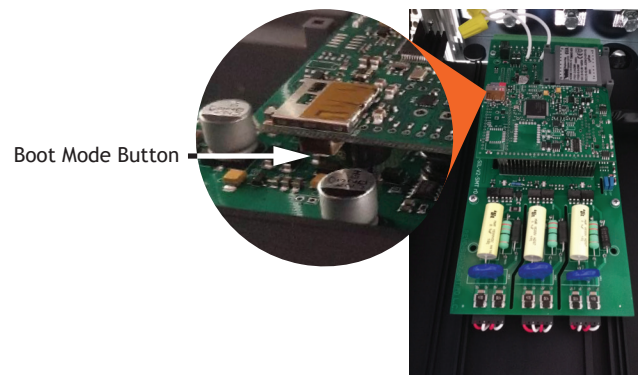

Once the firmware program is updated and runs, the normal home page display appears.

Troubleshooting

The following table lists symptoms, probable causes and possible actions.

Symptom	Indicator States*	Probable Causes	Possible Actions
No load current	"ON" is off	No auxiliary voltage	Ensure auxiliary voltage is properly connected
		No set point signal	Ensure set point signal is supplied
		Set point signal is connections reversed	Correct analog input 1 wiring
	"ON" is on	Fuse failure	Change the fuse
		Load connection open	Check the connections
	"ON" is on "HB" is on	Load failure	Check the load
"ON" is on "HB" is off	Power controller failure	Replace the power controller	
Unexpected output value		Auxiliary voltage out of limits	Check and correct the auxiliary voltage
		Incorrect set point signal selection	Check Local/Remote setting
		Set point signal scaling	Check Analog In 1 signal type setting

*Indicators in the ASPYRE Configurator PC software's Test view.

Troubleshooting Schematics

These illustrations are provided to help you understand the ASPYRE power controller when troubleshooting its use in an application.

⚠ CAUTION: Other than specifically listed in this manual, the internal components of the ASPYRE power controller are not user-serviceable. To avoid causing unsafe operation that can lead to property damage or loss of life, do not attempt to repair or alter the product.

⚠ ATTENTION : Outre ce qui est spécifié dans le présent manuel, les composants internes du régulateur de puissance ASPYRE ne peuvent pas être réparés par l'utilisateur. Pour éviter un fonctionnement dangereux pouvant entraîner des dommages à la propriété ou la perte de vie, ne pas essayer de réparer ou de modifier le produit.

Single-Phase Schematic

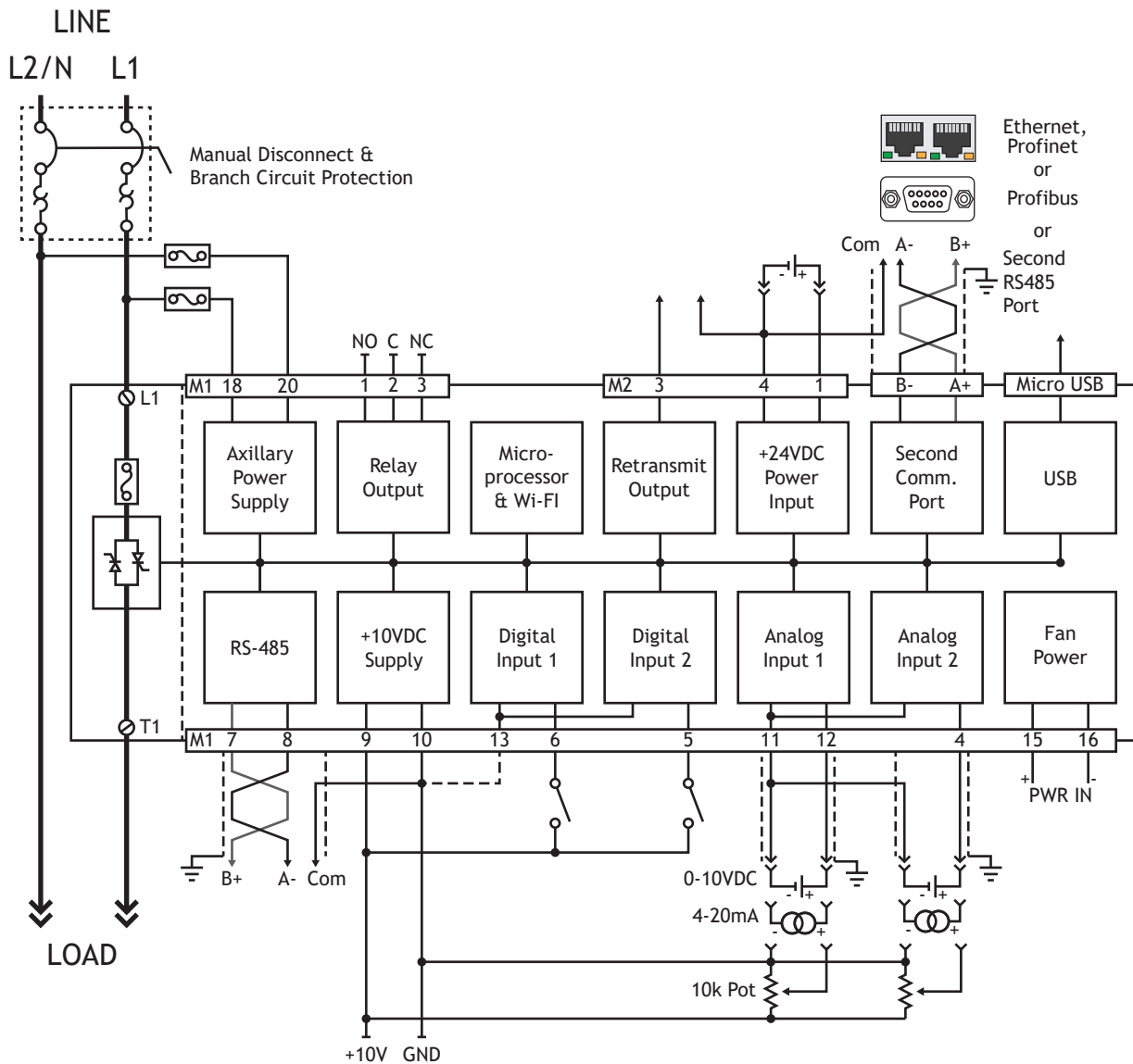

Two-Leg, Three-Phase Schematic

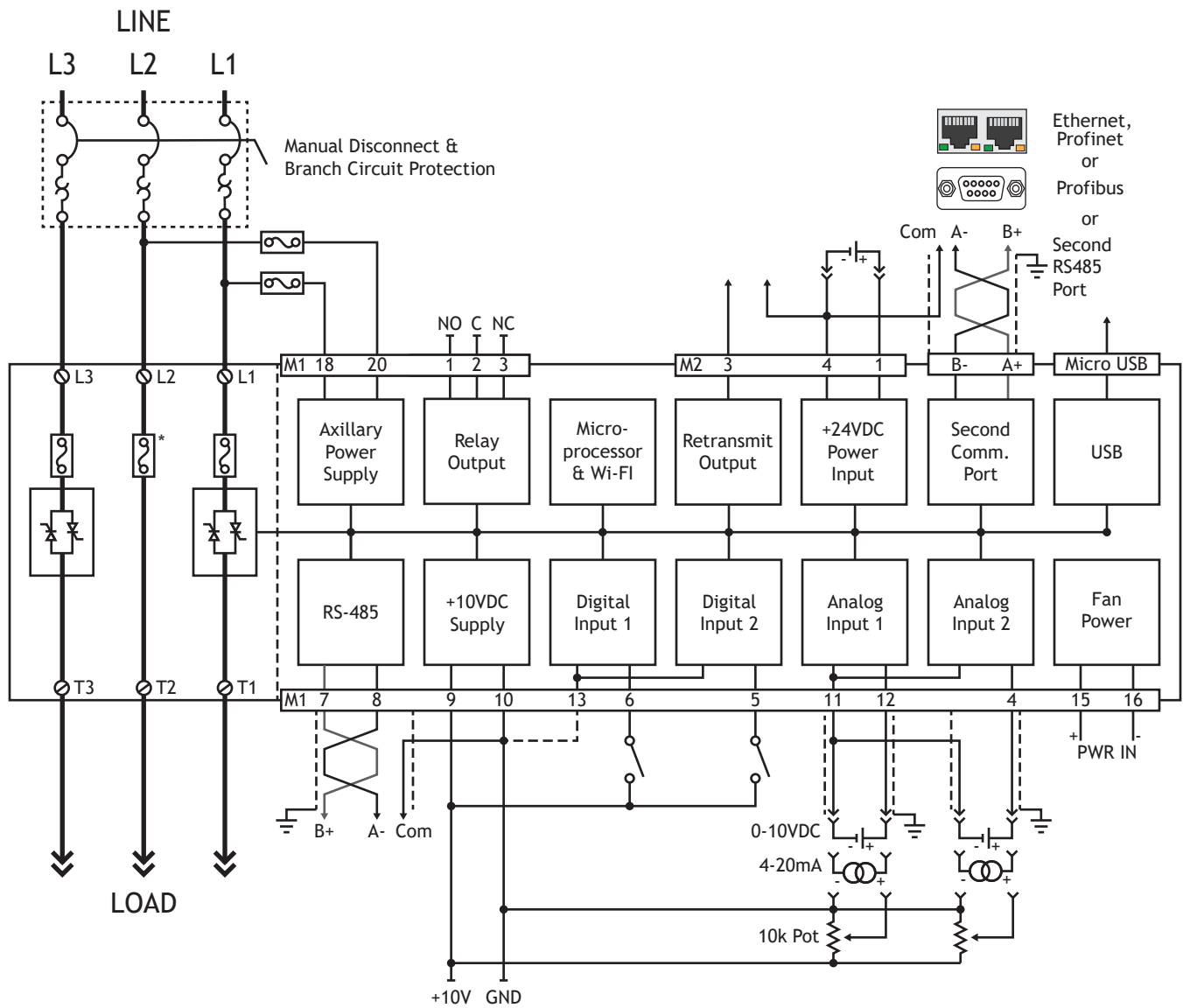

*No fuses for phase 2 in two-leg, three-phase, 600A & 700A models

Three-Leg, Three-Phase Schematic

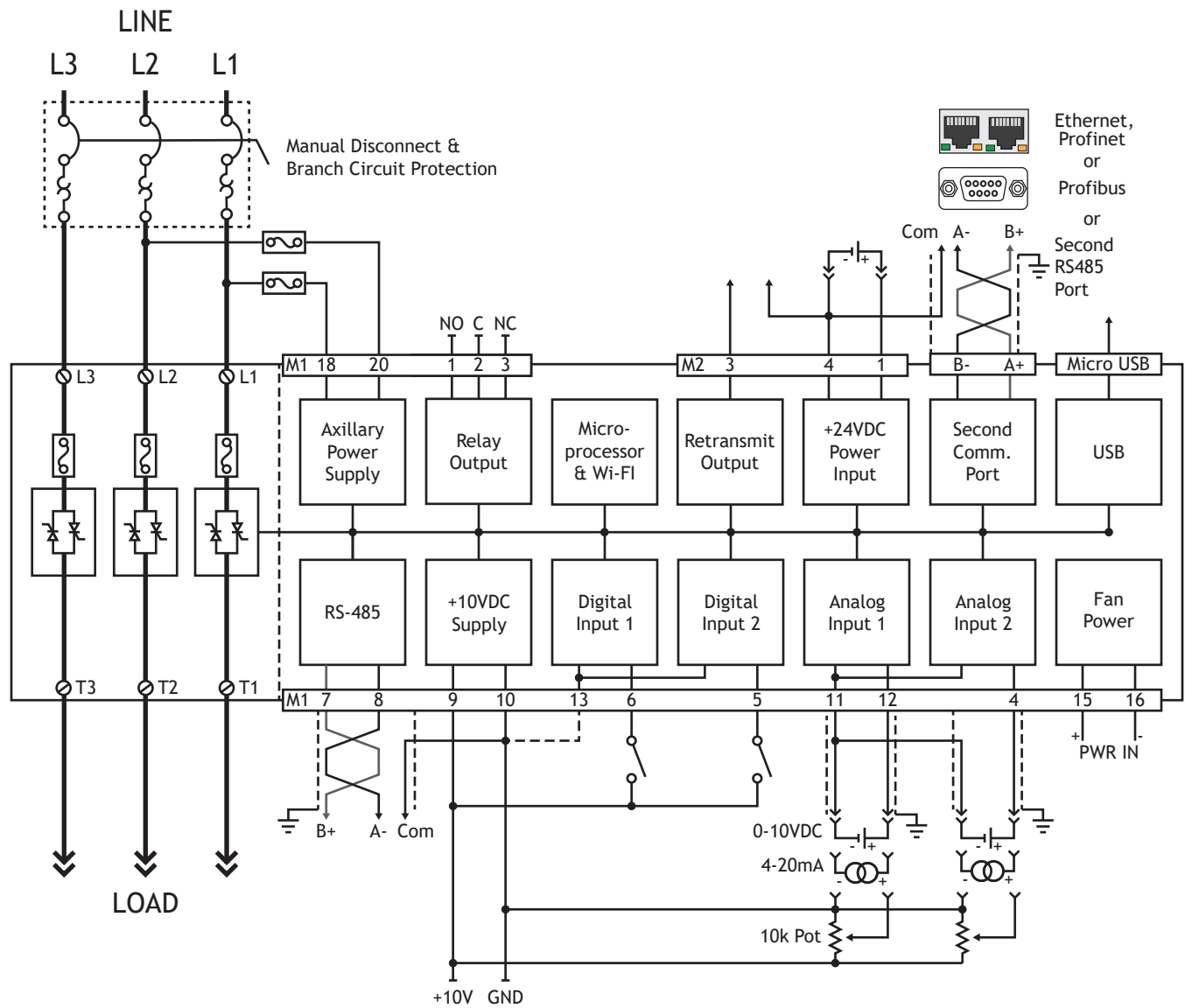

10

Communication

Overview

This chapter describes using the various options for communicating between an ASPYRE power controller and third-party devices and software.

Wiring

For information about wiring for the communication ports see “Communication Connections” on page 28.

Data Types

Each memory register contains an unsigned, 16-bit integer value. In a few cases the values from more than one register must be combined to read a single parameter value. For example, the kW Total parameter is stored in two 16-bit registers which must be combined in to a 32-bit long for display to users. These cases are indicated in the tables found later in this chapter. Any protocol specific types are indicated in the corresponding section.

Implied Decimals and Linear Scaling

Some values must be scaled from the units of measure in which they are displayed before being transmitted to the power controller, and conversely when read from the power controller via communications, these values must be scaled to the units of measure for display to users.

In some cases the value read via communications must be divided by a factor of ten because decimal precision is implied. For example, Frequency is measured and stored with two decimal place accuracy, but is transmitted via Modbus® TCP as a whole number with two implied decimal places.

In other cases the value read via communication must be scaled linearly from the range over which it is stored in the power controller to the range of values in the units of measure presented to the user. For example, the Set Point range 0% to 100% is stored in the power controller as value that ranges from 0 to 1023. When the set point is 50% the value read from the power controller is 511, not 500.

In all cases the necessary scaling is indicated in the tables found later in this chapter.

Enumerated Values

Some values represent data that is indicated by a word or short phrase. These enumerated values are listed in the tables found later in this chapter. For more thorough explanations see the parameter descriptions in the “Parameter Reference” chapter starting on page 53.

Bitwise Values

The *Status Bits* parameter indicates the states of alarms, digital inputs and other features with bits that correspond to each state. The *Command Bits* parameter supports switching features such as local or remote current limit on or off. For more details see “Status Bits” on page 68 and “Command Bits” on page 55.

To set a command bit without making other changes, read the command bits register, then write the value corresponding to the current setting with the one bit of interest changed.

Communication Watchdog

While a host device or software is connected via Modbus® TCP, Profibus DP or Profinet, the ASPYRE power controller must receive a message from the master at least once every 35 seconds. If the time between messages

exceeds this limit and when the connection is closed, the parameters in the holding registers are all set to zero (0) to ensure the unit is in a safe state. This feature does *not* apply to Modbus® RTU or EtherNet/IP™.

To disable this watchdog feature and control the power controller locally, disable the secondary communications. See “Port 2 Access” on page 64.

Enabling the Secondary Port

In order to be able to write parameter settings from the host to the ASPYRE power controller via the secondary communications port (port 2), you must set the *Port 2 Access* parameter to *Read and Write*. Do this using ASPYRE Configurator software or on the communication menu using the power controller’s built-in user interface.

Ethernet Network Setup

In order to establish communications, configure the Ethernet port in the ASPYRE power controller for your network. The IP address can be set only via the web page served by the ASPYRE power controller. View the current network settings for the power controller on the communication menu or using ASPYRE Configurator.

Default IP Settings in the ASPYRE Power Controller

	Modbus® TCP	EtherNet/IP™
IP Address	193.168.0.221	193.168.0.220
Subnet Mask	255.255.255.0	255.255.255.0
Gateway	0.0.0.0	0.0.0.0

To set the network address of the power controller:

1. With a standard Ethernet cable, connect the power controller directly to a computer.
2. Configure the computer’s network interface with a unique IP address on the sub-network with the power controller.
3. Open a browser and set the URL to the actual IP address (eg. <http://192.168.0.221>).
4. Click **Settings**.
5. For **Username** type: `user`
6. For **Password** type: `shImpAiR`
7. Click **Log in**.
8. On the settings page enter the desired IP address and subnet mask and click **Submit**.

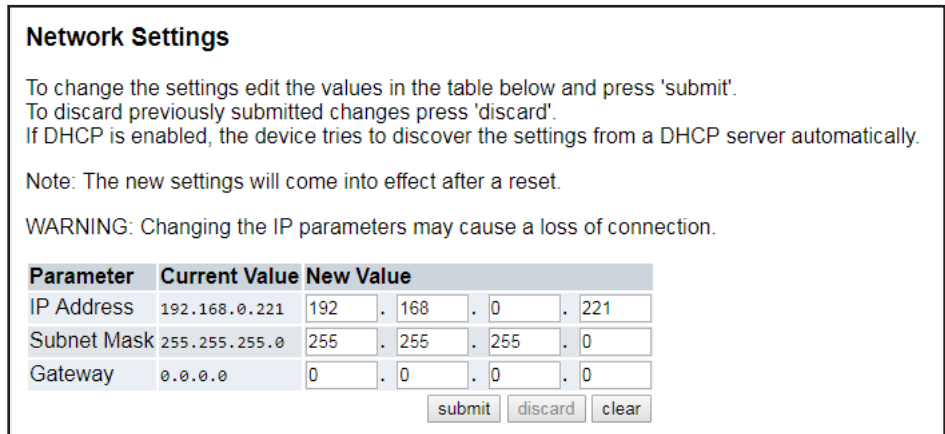
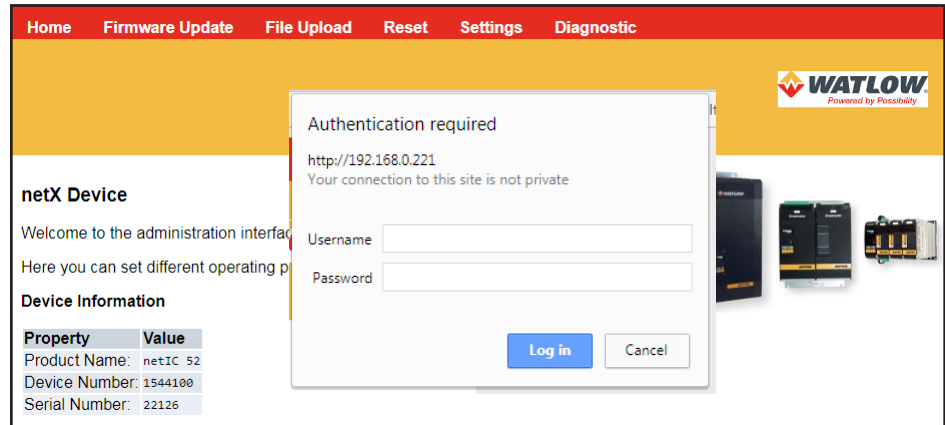

Modbus® TCP

This section describes communicating with an ASPYRE power controller via the Modbus® TCP communication option. The typical application for this protocol is using a programmable logic controller or other automation equipment to control the power controller.

Features

The Modbus® TCP option supports the following features.

Broadcast Messages

The ASPYRE power controller supports Modbus® TCP broadcast messages. Send broadcast messages using station address 0. All ASPYRE power controllers on the local area network act on the message contents without sending back any reply.

⚠NOTE! When the Command Bits parameter is set to zero, the Set Point Source and I Limit Local / Remote parameters are each set to accept signal from the analog inputs. If the application normally uses the secondary communication port to set the Set Point and I Limit values, the Command Bits parameter must be initialized accordingly each time the master connects to the power controller.

Supported Functions

The ASPYRE power controller supports the Modbus® TCP functions listed below.

Function	Description
04	Read the input registers (30,001 to 39,999)
03	Read the holding registers (40,001 to 49,999)
06	Write a single holding register
16	Write multiple holding registers

EtherNet/IP™ Setup

This section describes communicating with an ASPYRE power controller via the EtherNet/IP™ communication option. The typical application for this protocol is using a programmable logic controller or other automation equipment to control the power controller.

Features

The ASPYRE power controller supports two instances of the assembly class.

	Instance	Tag Letter	Description
Input	100	I	Data produced by the power controller
Output	101	O	Data consumed by the power controller

Data Types

Each value is a 16-bit integer unless specified as a BOOL array.

Necessary Tools

The following instructions were created using a Windows® PC with Rockwell® Automation RSLogix® 5000 version 20.04.

Importing the EDS File

The EDS file maps the ASPYRE power controller parameters in to the tag database for the PLC project.

To import the EDS file:

1. Download the EDS file for the ASPYRE power controller from the Watlow website. It is linked to the product page in the Related Documentation section under Software & Demos.
<http://www.watlow.com/en/products/controllers/power-switching-devices/aspire-intelligent-power-controllers>
2. Launch the EDS Hardware Installation Tool found under the Rockwell Software / RSLinx / Tools and choose **Add**.
3. Follow the prompts to import the ASPYRE EDS file.
4. Launch RSLogix 5000 and open the desired project.
5. In the **Controller Organizer**, right-click the PLC's **Ethernet** port and choose, **New Module**.

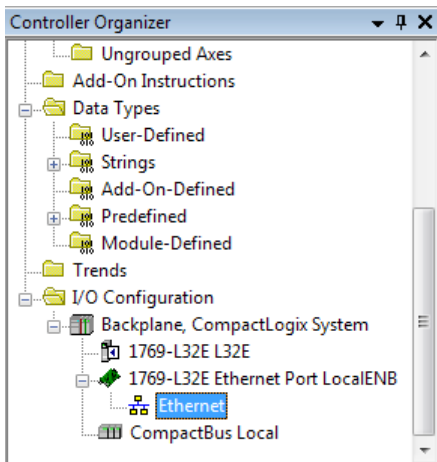

6. Search for "Aspyre".

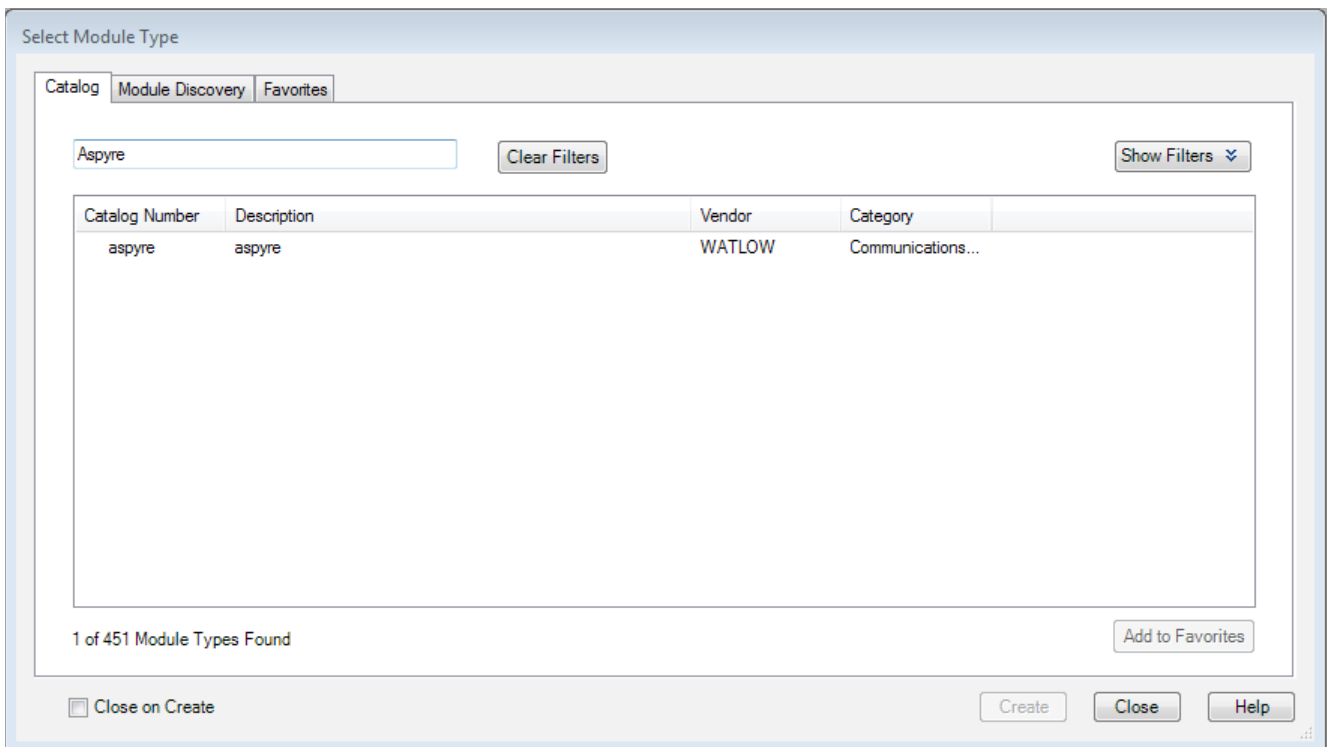

7. Select the ASPYRE module.
8. Click **Create**.

9. Enter a **Name**, **Description** and the power controller's **IP Address**.

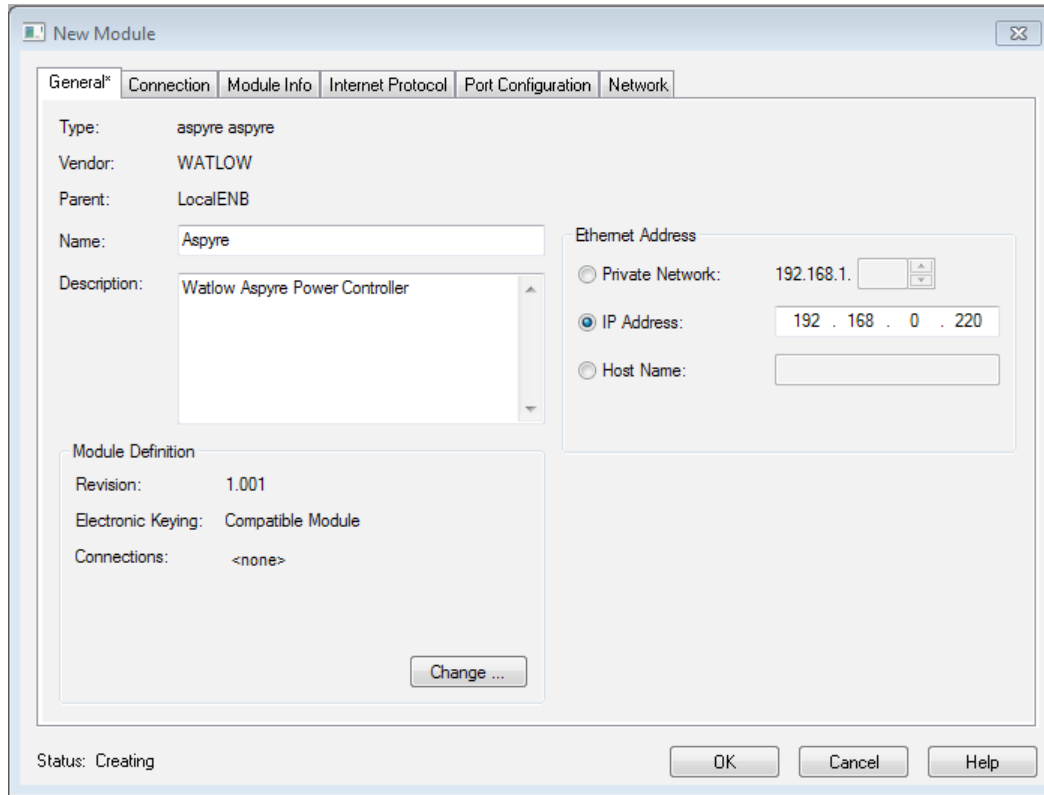

10. Click **Change...**

11. For **Connections** under **Name** choose **Exclusive Owner**.

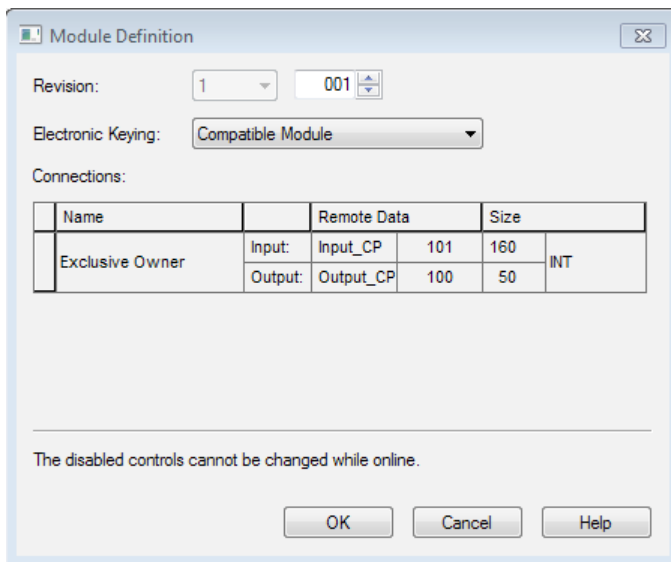

12. For the **Input** data set **Size** to 160.

13. For the **Output** data set **Size** to 50.

14. For the data type choose **INT**.

15. Click **OK** to close the **Module Definition** dialog.

16. Click **OK** to close the **New Module** dialog.

17. Click **Close**.

Creating Aliases for Tags

With the project offline, you can browse through the imported tags and apply alias names to make the parameters easier to recognize when using them in your project. See the names suggested for input tags in the table in “Holding Registers” on page 113 and names suggested for output tags in the table in “Input Registers” on page 114.

Profinet IO Setup

This section describes communicating with an ASPYRE power controller via the Profinet IO communication option. The typical application for this protocol is using a programmable logic controller or other automation equipment to control the power controller.

Necessary Tools

The following instructions were created using a Windows® PC with Siemens® TIA Portal software.

Importing the GSD file

The GSD file maps the ASPYRE power controller parameters in to the tag database for the PLC project.

To import the GSD file:

1. Download the GSD file for the ASPYRE power controller from the Watlow website. It is linked to the product page in the Related Documentation section under Software & Demos.
<http://www.watlow.com/en/products/controllers/power-switching-devices/aspyre-intelligent-power-controllers>
2. Unzip the downloaded archive file and place the items in a folder together where you can find them for the steps below.
3. Launch the Siemens® TIA Portal software.
4. Open or create a new project that includes the PLC.
5. From **Options** menu choose **Manage general station description files (GSD)**.
6. Browse to the folder containing the GSD file.
7. Select **GSDML-V2.33-WATLOW-ASPYRE-20180206.xml**.
8. Click **Install**.
9. Click **Close**.

Adding ASPYRE to an existing TIA Portal Project:

1. Select **Devices & Networks** in your TIA Portal project and locate the **Network view** in the upper right corner.

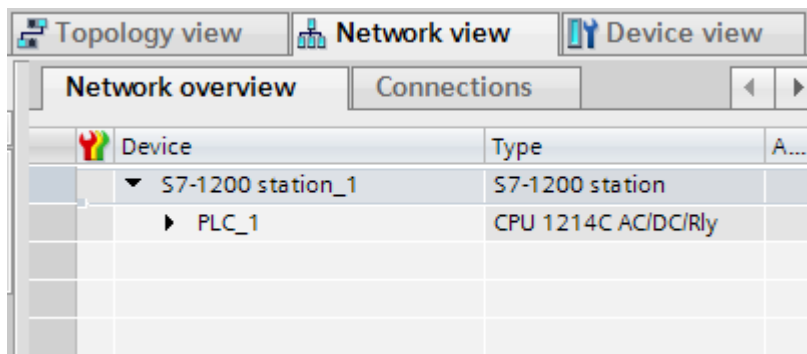

- Drag the ASPYRE from the **Hardware catalog** on the right to the **Network view** in the center of the application window. (See figure.)

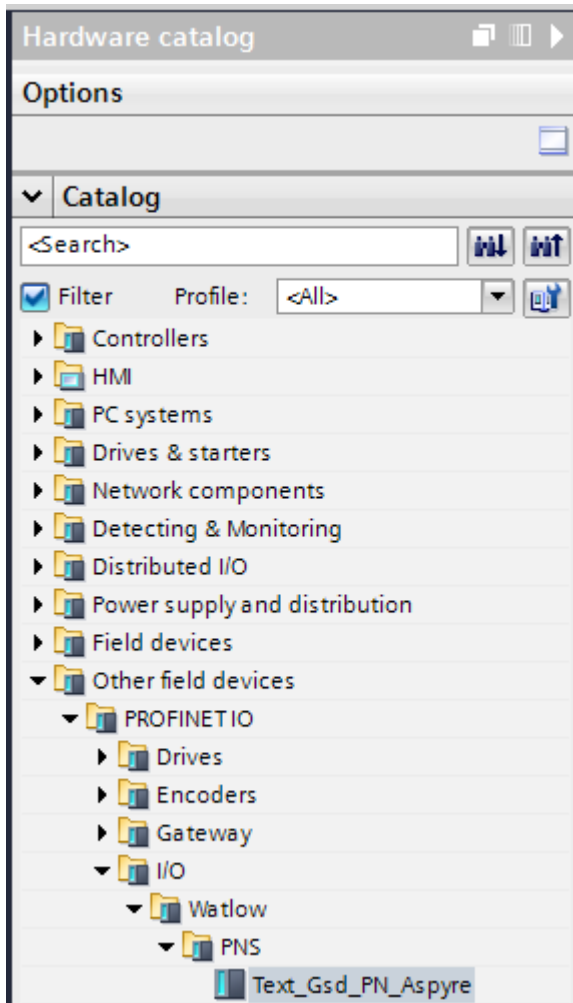

- Click and drag from the green square on the ASPYRE onto the Profinet network or to the green box on the PLC CPU.

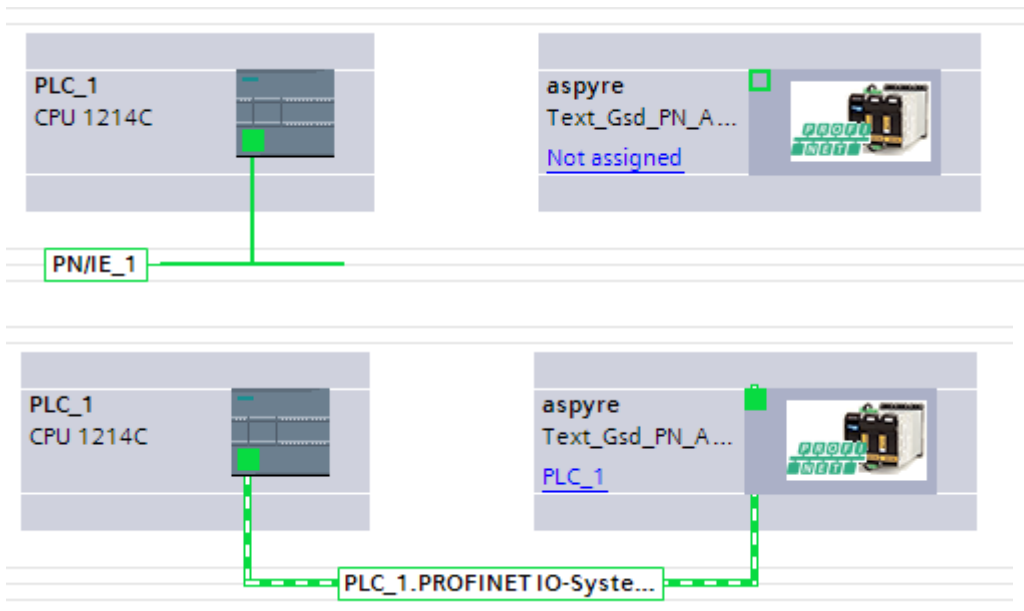

4. Right-click the ASPYRE and choose **Assign device name**.

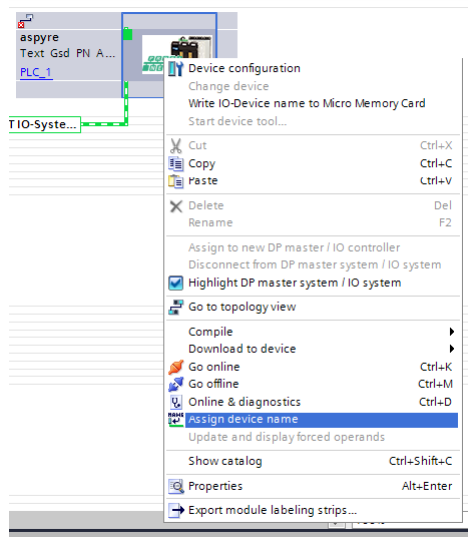

5. In the **Assign PROFINET device name** dialog click **Update list**.

6. Select the Aspyre device in the list and click **Assign name**.

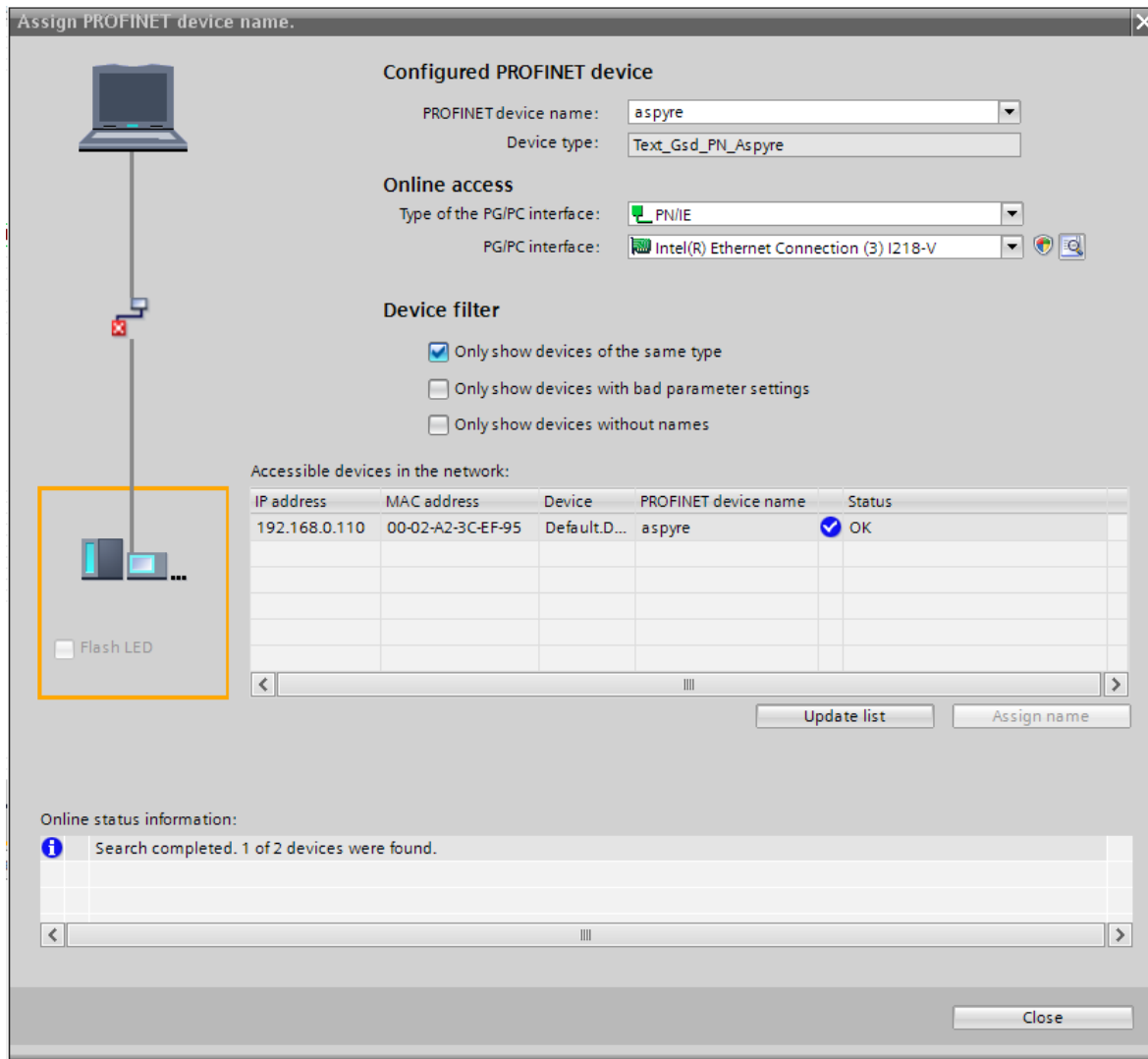

7. Click **Close**.

8. Click **Go online**.

9. Right-click the ASPYRE and choose **Online & diagnostics**.

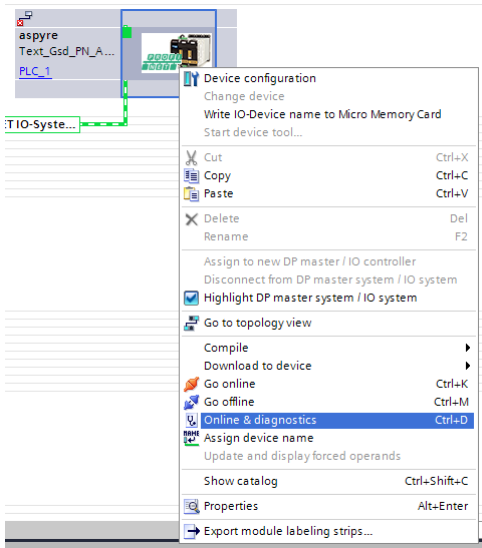

10. In the properties list expand **Functions** and select **Assign IP address**.

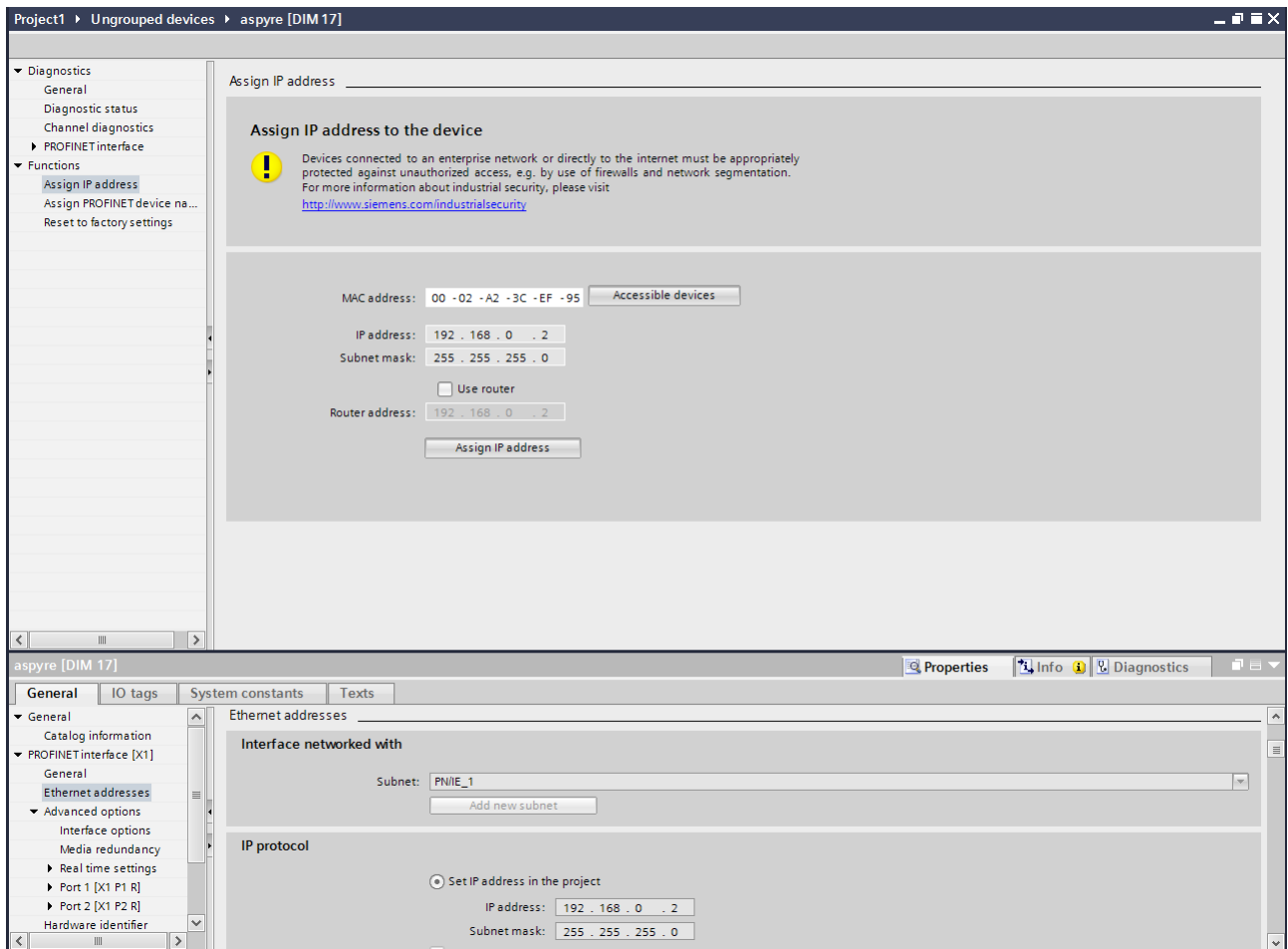

This uses the IP address specified in the device’s General -> Profinet Interface -> Ethernet Address tab.

11. Click **Accessible devices**.
12. Click **Start Search**.
13. Select the ASPYRE power controller in the list.
14. Click **Apply**.
15. Close the **Diagnostics window**.

16. In the **Network view** select the ASPYRE.
17. Click the **Device view** tab.
18. Click **Go offline**.
19. For each slot listed in the table below:
 - Click and drag the listed **Input Module** or **Output Module** from the **Hardware catalog** to the slot
 - Set the starting address as indicated by editing the **I address** or **Q address**

Slot	Module	I address	Q address
1	16 Bytes Output		100
5	64 Bytes Input	100	
6	64 Bytes Input	164	

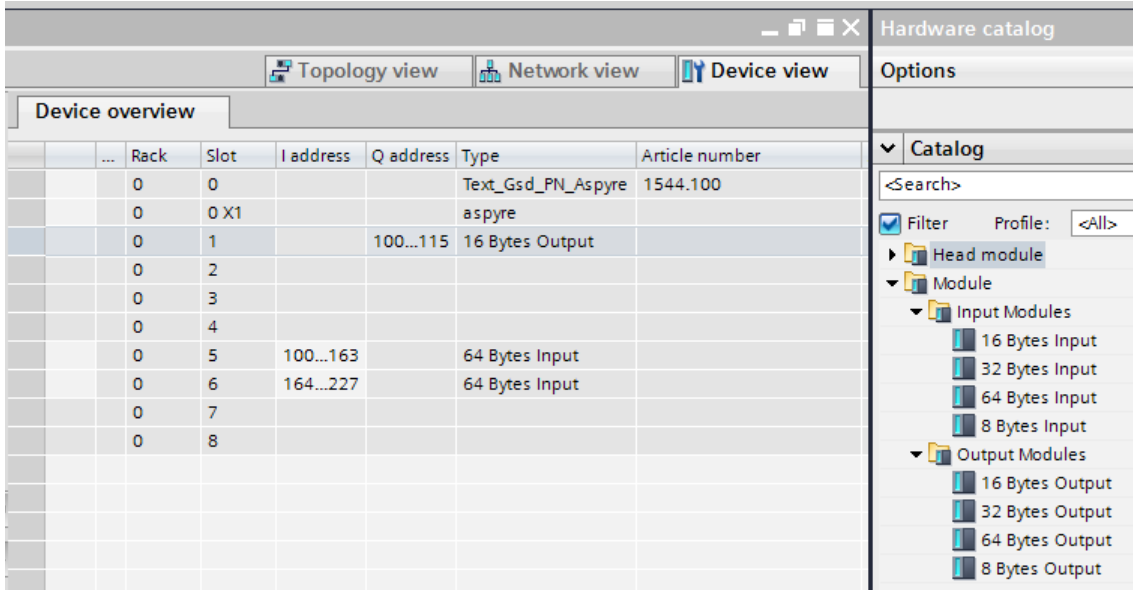

Importing the Tag File

Once the I/O is mapped importing the tag file makes it easier to use the data by supplying human human-readable names for each parameter.

Add a tag table and watch table to the project for accessing data:

1. In the **Project tree** window, under your PLC, find **PLC tags** and click **Add new tag table**.
2. Select the new tag table.
3. In the tag table window click the **Import** button
4. Locate and open the *Aspyre Tag Table.xml* file that was downloaded with the GSD file.
5. Click **OK**.
6. Click **Go online**.

7. In the tag table, click **Monitor all**.

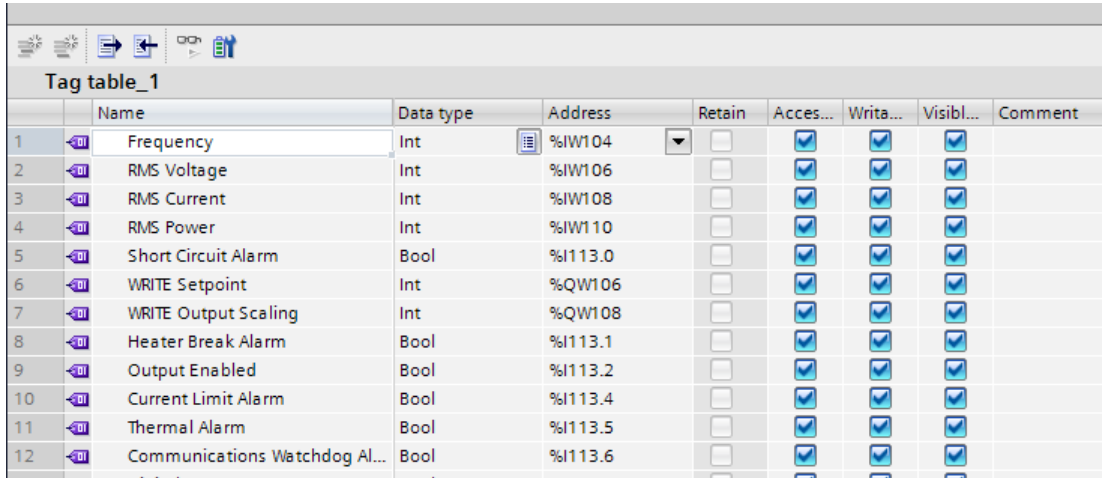

	Name	Data type	Address	Retain	Acces...	Writa...	Visibl...	Comment
1	Frequency	Int	%IW104	<input type="checkbox"/>	<input checked="" type="checkbox"/>	<input checked="" type="checkbox"/>	<input checked="" type="checkbox"/>	
2	RMS Voltage	Int	%IW106	<input type="checkbox"/>	<input checked="" type="checkbox"/>	<input checked="" type="checkbox"/>	<input checked="" type="checkbox"/>	
3	RMS Current	Int	%IW108	<input type="checkbox"/>	<input checked="" type="checkbox"/>	<input checked="" type="checkbox"/>	<input checked="" type="checkbox"/>	
4	RMS Power	Int	%IW110	<input type="checkbox"/>	<input checked="" type="checkbox"/>	<input checked="" type="checkbox"/>	<input checked="" type="checkbox"/>	
5	Short Circuit Alarm	Bool	%I113.0	<input type="checkbox"/>	<input checked="" type="checkbox"/>	<input checked="" type="checkbox"/>	<input checked="" type="checkbox"/>	
6	WRITE Setpoint	Int	%QW106	<input type="checkbox"/>	<input checked="" type="checkbox"/>	<input checked="" type="checkbox"/>	<input checked="" type="checkbox"/>	
7	WRITE Output Scaling	Int	%QW108	<input type="checkbox"/>	<input checked="" type="checkbox"/>	<input checked="" type="checkbox"/>	<input checked="" type="checkbox"/>	
8	Heater Break Alarm	Bool	%I113.1	<input type="checkbox"/>	<input checked="" type="checkbox"/>	<input checked="" type="checkbox"/>	<input checked="" type="checkbox"/>	
9	Output Enabled	Bool	%I113.2	<input type="checkbox"/>	<input checked="" type="checkbox"/>	<input checked="" type="checkbox"/>	<input checked="" type="checkbox"/>	
10	Current Limit Alarm	Bool	%I113.4	<input type="checkbox"/>	<input checked="" type="checkbox"/>	<input checked="" type="checkbox"/>	<input checked="" type="checkbox"/>	
11	Thermal Alarm	Bool	%I113.5	<input type="checkbox"/>	<input checked="" type="checkbox"/>	<input checked="" type="checkbox"/>	<input checked="" type="checkbox"/>	
12	Communications Watchdog Al...	Bool	%I113.6	<input type="checkbox"/>	<input checked="" type="checkbox"/>	<input checked="" type="checkbox"/>	<input checked="" type="checkbox"/>	

With the project online, the data from the controller is listed in the tag table window.

Watch tables and force tables can be created to use the read-write tags. These tags have names beginning with "WRITE" making them easy to find. These are the only parameters in the tags list that can be written to.

Profibus DP Setup

This section describes communicating with an ASPYRE power controller via the Profibus DP communication option. The typical application for this protocol is using a programmable logic controller or other automation equipment to control the power controller.

Features

The ASPYRE power controller supports cyclic data exchange via Profibus DP (DP-V0). A General Station Description (GSD) file is provided to configure the PLC.

Necessary Tools

The following instructions were created using a Windows® PC with Siemens® SIMATIC Manager software.

Importing the GSD File

The GSD file maps the ASPYRE power controller parameters in to the tag database for the PLC project.

To import the GSD file:

1. Download the GSD file for the ASPYRE power controller from the Watlow website. It is linked to the product page in the Related Documentation section under Software & Demos.
<http://www.watlow.com/en/products/controllers/power-switching-devices/aspire-intelligent-power-controllers>
2. Launch the Siemens® SIMATIC Manager software.
3. Create a new project.
4. Select the system and double-click **Hardware**.

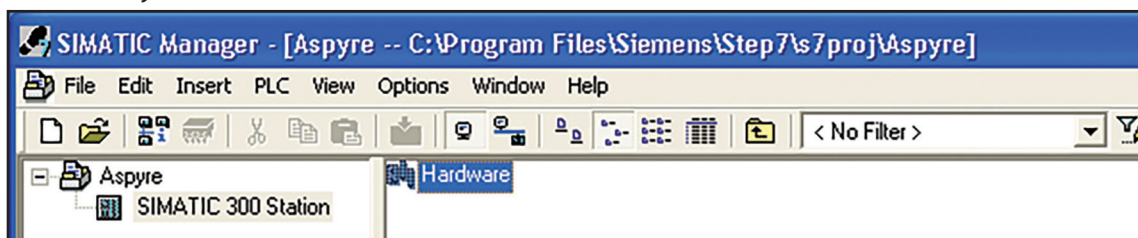

5. In the toolbox, double-click the PLC you are using to add it to the project.

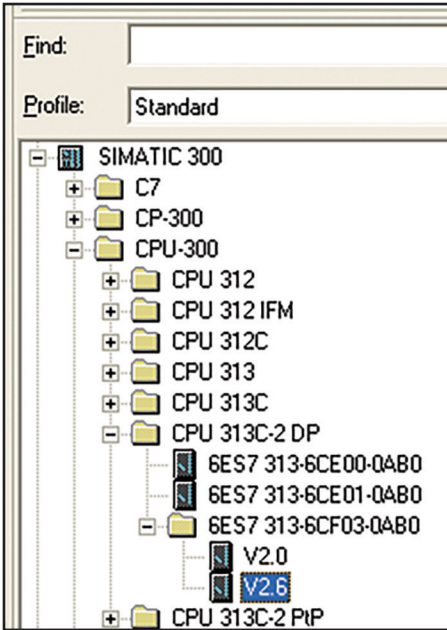

6. Right-click the PLC and choose **Add Master System**.

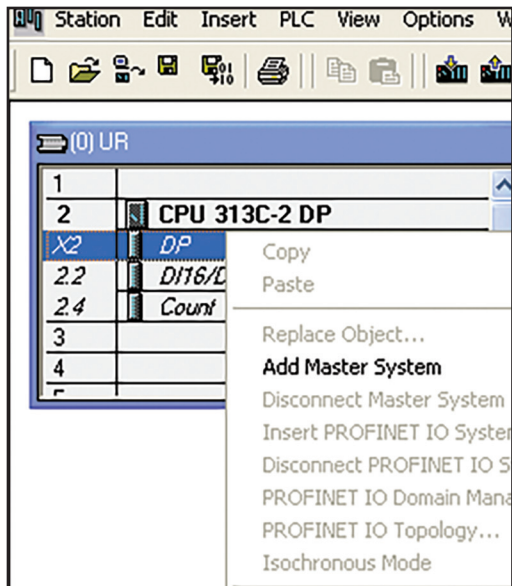

7. Click **New...** to create a new subnet for the master system.

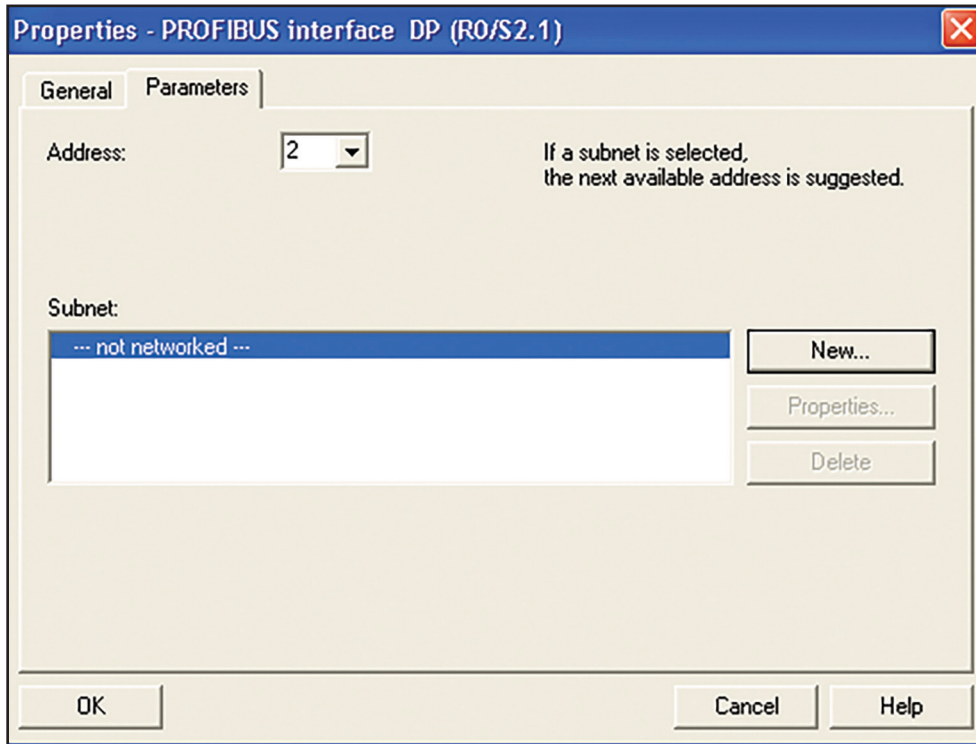

8. Click **OK** to add the subnet.

9. Click **OK** to close the **Properties** dialog.

10. From the **Options** menu choose **Install GSD File...**

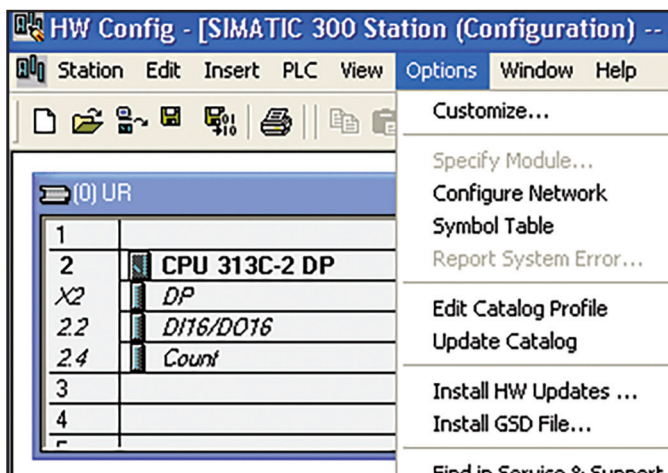

11. Browse to the location of the GSD file and select it and install it.

12. Search the toolbox for **ASPYPE-DPS** to locate the ASPYRE power controller.

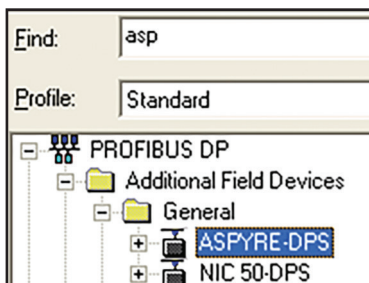

13. Drag it from the toolbox to the network.

14. In the **Properties** dialog set **Address** to the ASPYRE power controller's Port 2 Address.

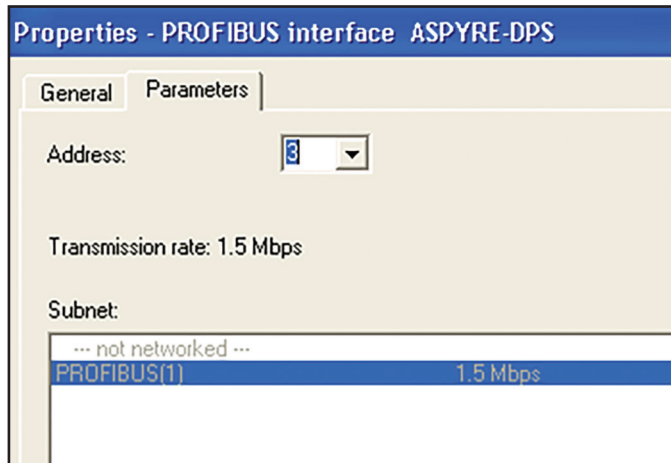

15. Click **OK** to close the **Properties** dialog.

16. Once the device appears in the system, select it so you can set the location of the power controller's data.

17. Click and drag the blocks needed for each slot.

Slot	Block	Start Address
1	8 Words Out	0
2	32 Words In	0
3	16 Words In	64
4	8 Words In	96
5	4 Words In	112

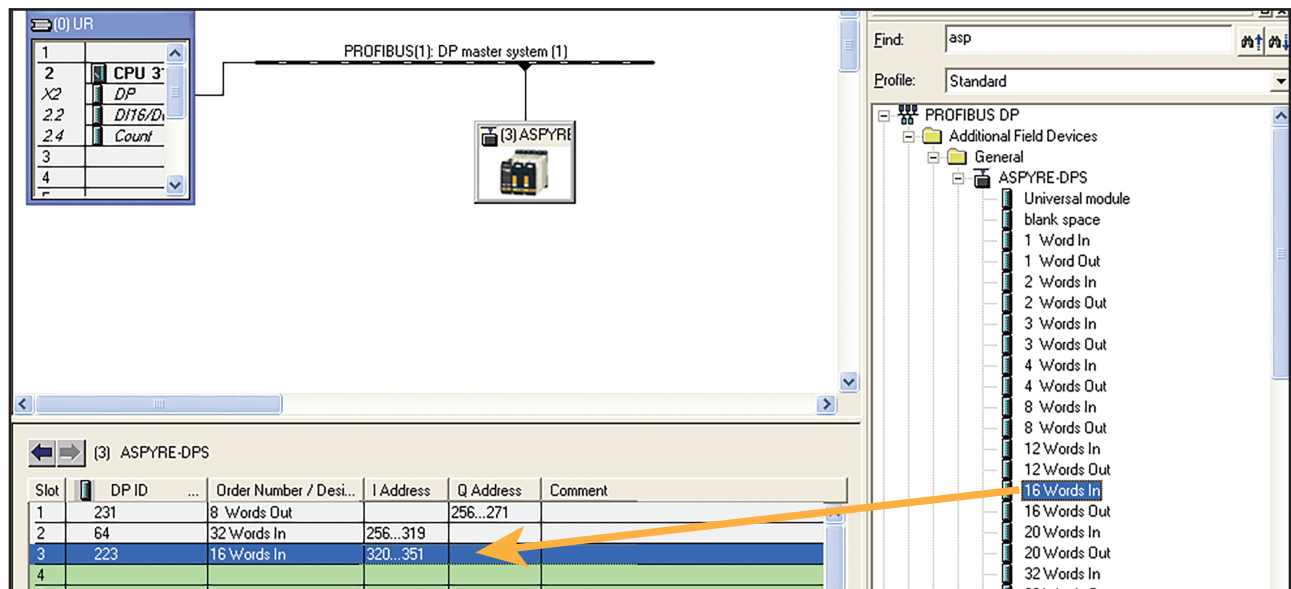

18. To make the power controller's parameters easier to locate when using them in your project, double click each block and set the corresponding **Start Address**. (See table in the step above.)

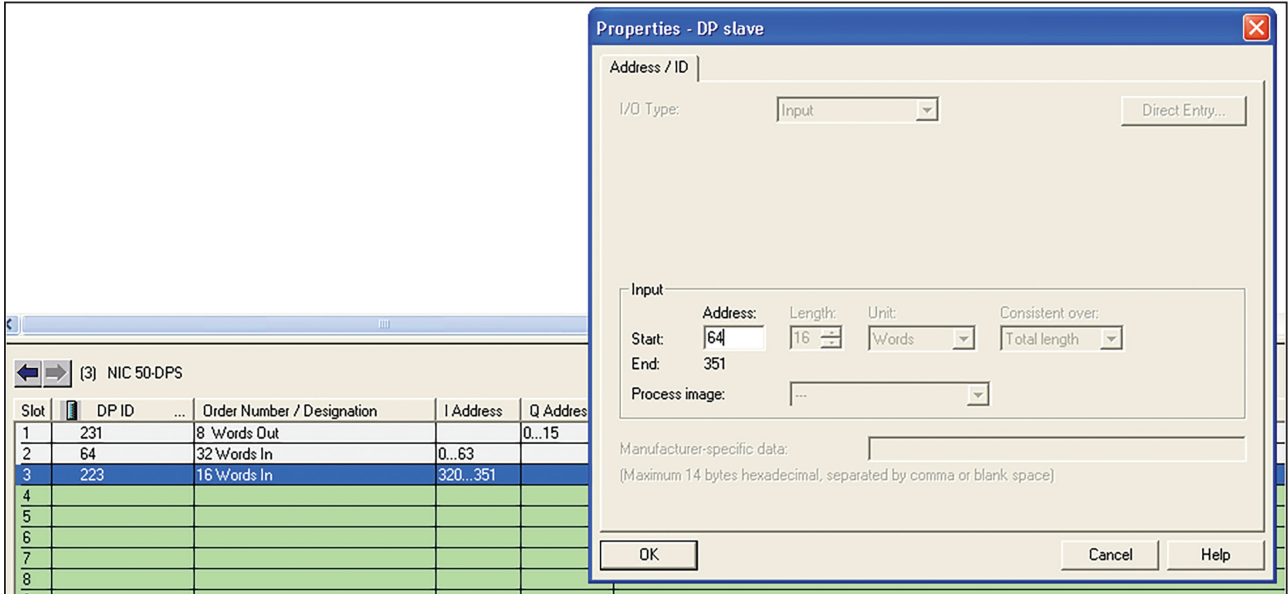

19. Download the hardware configuration and restart the PLC.

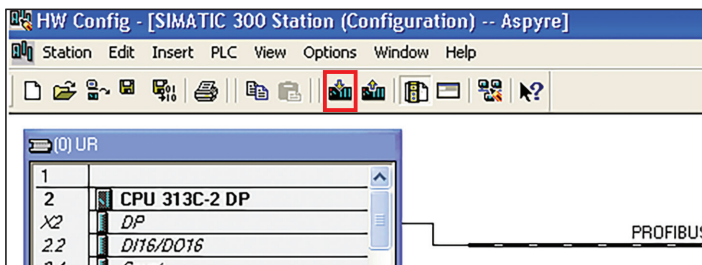

20. Save the configuration and close the HW Config window.

Monitoring the PLC

Once the tag database is imported in to the PLC project, you can use the variable table to view the ASPYRE power controller parameters.

To monitor parameter values:

1. In the Siemens® SIMATIC Manager project browser under the project, the station, the PLC and the program, select **Blocks**.
2. Right-click in the window and under **Insert New Object** choose **Variable Table**.

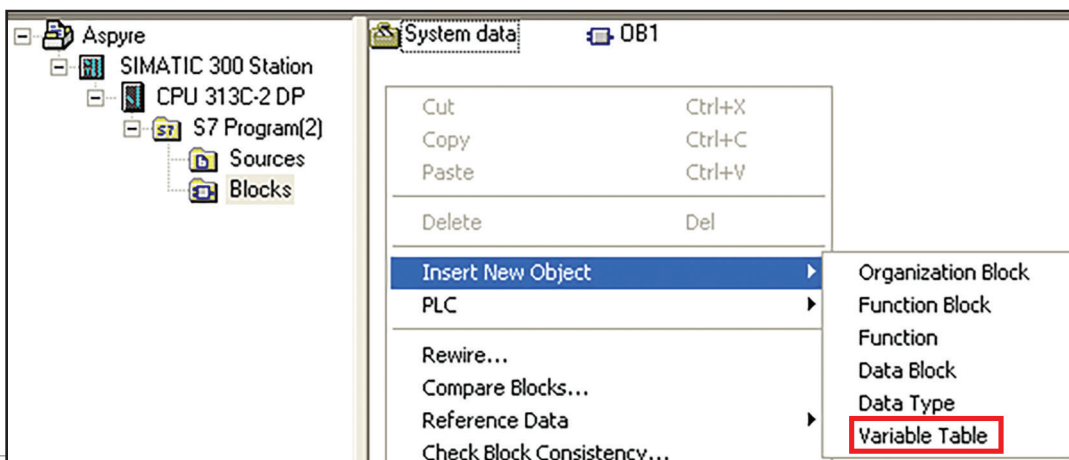

3. Name the table and click **OK**.
4. Double-click the new table.
5. For the write parameters:
 - From the **Insert** menu choose **Range of Variables...**

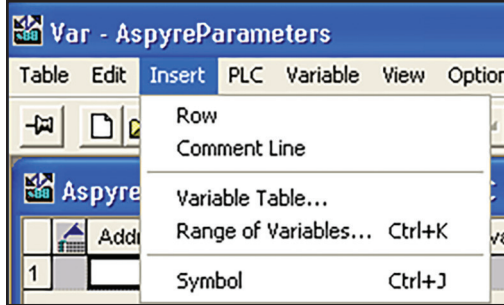

- Set **As of address** to **QW0**.
- Set **Number** to **8** words.

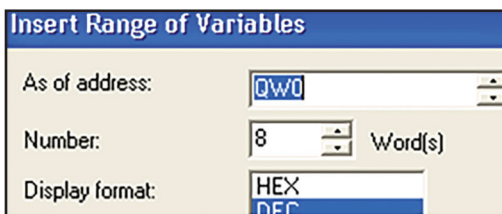

- Click **OK**.
6. For the read parameters:
 - From the **Insert** menu choose **Range of Variables...**
 - Set **As of address** to **IW0**.
 - Set **Number** to **48** words.

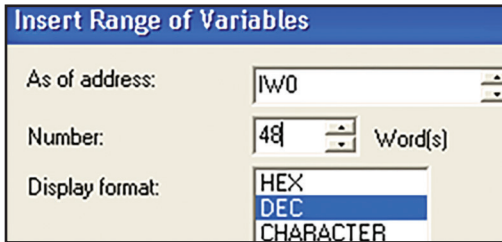

- Click **OK**.

7. Click the monitor tool to go online and monitor communication.

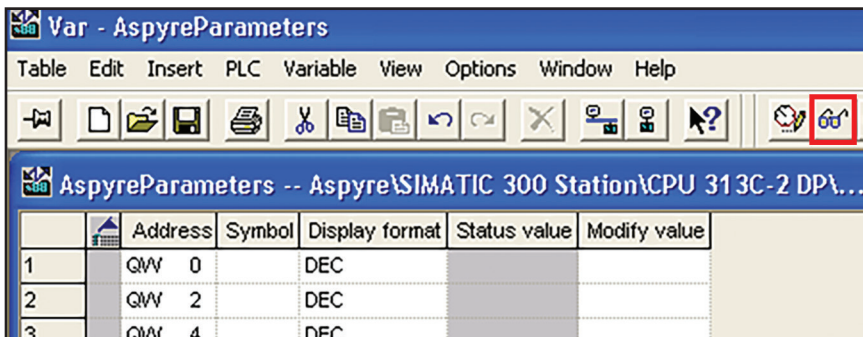

When online, the parameter values are displayed in the **Status Value** column.

To alter one or more parameter values:

1. Type the desired value(s) in the **Modify value** column.
2. Click the modify variable tool.

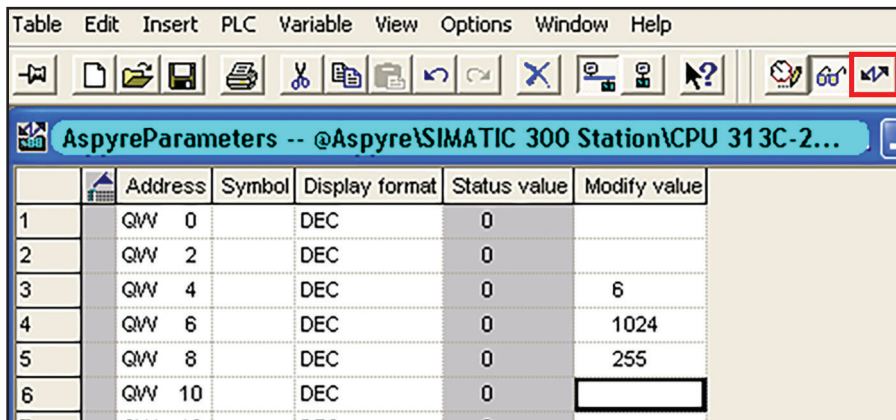

Holding Registers

The table below lists the parameters that may be read and written using any of the secondary communications options other than Modbus® RTU. For Modbus® RTU registers see “Modbus® RTU Holding Registers” on page 117.

For each parameter and the following information is listed:

- Parameter: the name of the parameter
- Register/Tag Number/Word Offset: the Modbus® TCP register or tag number for EtherNet/IP™ or word bus offset for Profibus that holds the parameter value
- Byte Offset: the byte bus offset for Profibus DP that holds the parameter value
- Max: the maximum value of the parameter (the minimum is always zero.)
- Encoding: follow these instructions to convert values in the units of measurement before sending to the controller
- Units: units of measurement

Parameter	Register Tag Number Word Offset	Byte Offset	Max	Encoding	Units
Not used	0	0			
Not used	1	2			
Command Bits	2	4		bit 1 = local (1) / remote (0) set point* bit 2 = enable (1) / disable (0) output** bit 4 = local (1) / remote (0) current limit (all others unused)	
Set Point	3	6	1023	Multiply displayed percentage by 10.23	%
Out Scale	4	8	255	Multiply displayed percentage by 2.55	%

*When using a power controller with a secondary communication port other than Modbus® RTU, with Port 2 Access set to *Read and Write*, the local / remote option is determined only by command bit 1 regardless of whether or not a digital input is configured to set this option.

**When using a power controller with a secondary communication port other than Modbus® RTU, with Port 2 Access set to *Read and Write* and the power controller configured to be enabled by a digital input, the power controller is enabled only when the digital input and command bit 2 are *both* on.

Input Registers

The table below lists the parameters that may be read via using any of the secondary communications options other than Modbus® RTU. For Modbus® RTU registers see “Modbus® RTU Holding Registers” on page 117.

For each parameter and the following information is listed:

- Parameter: the name of the parameter
- Register/Tag Number/Word Offset: the Modbus® TCP register or tag number for EtherNet/IP™ or word bus offset for Profinet that holds the parameter value
- Byte Offset: the byte bus offset for Profibus DP that holds the parameter value
- Max: the maximum value of the parameter (the minimum is always zero.)
- Decoding: follow these instructions to display the value in the units of measurement
- Units: units of measurement

For bitwise and enumerated parameters the decoding instructions span the Max, Decoding and Units columns.

Parameter	Register Tag Number Word Offset	Byte Offset	Max	Decoding	Units
Not used	0	0			
Not used	1	2			
Frequency	2	4	65535	Divide value by 100	Hz
V Output	3	6	9999	Divide value by 10	V
I Output	4	8	9999	Divide value by 10	A
Power	5	10	100	Display value as is	%
Status Bits	6	12	bit 0 = SCR Short alarm (1) / no alarm (0) bit 1 = Heater break alarm (1) / no alarm (0) bit 2 = Output enable (1) / disabled (0) bit 4 = Current limit alarm (1) / no alarm (0) bit 5 = Thermal alarm (1) / no alarm (0) bit 6 = Communication alarm (1) / no alarm (0) bit 8 = Digital input 1 on (1) / off (0) bit 9 = Digital input 2 on (1) / off (0) bit 10 = Unbalanced alarm (1) / no alarm (0) bit 13 = phase loss alarm (1) / no alarm (0) bit 14 = Heater bakeout on (1) / off (0) bit 15 = Latched thermal alarm (1) / no alarm (0) (all others unused)		
Command Bits	7	14	bit 1 = local (1) / remote (0) set point bit 2 = enable (1) / disable (0) output bit 4 = local (1) / remote (0) current limit (all others unused)		
Set Point	8	16	1023	Divide value by 10.23	%
Out Scale	9	18	255	Divide value by 2.55	%
I Limit*	10	20	1023	Divide value by 10.23	%
Nominal V	11	22	1023	Display value as is	V
Nominal I	12	24	9999	Divide value by 10	A
Leg 1 I Output**	13	26	4096	Divide value by 10	A
Leg 2 I Output**	14	28	4096	Divide value by 10	A
Leg 3 I Output**	15	30	4096	Divide value by 10	A
V Input (47)	16	32	65535	Divide value by 10	V

Parameter	Register Tag Number Word Offset	Byte Offset	Max	Decoding	Units
kVA Real Time	17	34	65535	Divide value by 100	kVA
kW Real Time	18	36	9999	Display value as is	kW
kW Total LSW	19	38	Combine for 32-bit, unsigned integer and divide by 10		kWh
kW Total MSW	20	40			
Power Factor	21	42	1000	Divide value by 1000	ratio
Not used	22	44			
Not used	23	46			
SCR Temperature	24	48	0 = OK, 130 = Over Temp		
Load Ω	25	50	65535	Divide value by 100	Ohm
Not used	26	52			
Unit Type	27	54	7 = 1 Leg, 8 = 2 Leg, 3 = 3 Leg (zero cross), 10 = 3 Leg (phase angle)		
Max Voltage	28	56	1023	Display value as is	V
Max Current	29	58	9999	Divide value by 10	A
Aux Voltage	30	60	1023	Display value as is	V
Firing	31	62	1 = Zero Cross 2 = Single Cycle* 3 = Burst Fire 4 = Phase Angle* 10 = Half Cycle ((DT1 only) 19 = Burst Fire Start Ramp* 20 = Phase Angle Soft Start* 35 = Burst Fire Delay Trigger* 74 = Half Cycle Safety Ramp (DT1 only) 99 = BF Strt Rmp Delay Trigger*		
Feedback	32	64	0 = Voltage ² 1 = None 2 = Current ² 32 = Voltage 64 = Current 128 = Power 256 = External		
Limit Peak Current*	33	66	0 = RMS Current, 1 = Peak Current		
Remote SP	34	68	0 = Analog In 1, 1 = Analog In 2		
Analog In 1 [Value]	35	70	1023	Divide value by 10.23	%
Analog In 2 [Value]	36	72	1023	Divide value by 10.23	%
Digital In 1 Function	37	74	0 = Enable 2 = Voltage Feedback 3 = Local / Remote 4 = Phase Angle*		
Digital In 2 Function	38	76	5 = Set Point Analog In 1 / 2 6 = Logging 7 = Heater Bakeout*		

Parameter	Register Tag Number Word Offset	Byte Offset	Max	Decoding	Units
Alarm Function	39	78		0 = None 1 = Heater Break (HB) 2 = SRR Short (SC) 3 = HB / SC 4 = I Limit* (IL) 5 = HB / IL* 6 = SC / IL* 7 = All (HB / SC / IL)* 16 = Watchdog (WD) 17 = WD / HB 18 = WD / SC 19 = WD / HB / SC 20 = WD / IL* 21 = WD / HB / IL* 22 = WD / SC / IL* 23 = WD / HB / SC / IL*	
Safety Ramp Off Time	40	80	65535	Display value as is	x50ms
Safety Ramp Duration	41	42	65535	Display value as is	x50ms
Heater Bakeout*	42	84	0 = Off, 1 = On		
Bakeout Ramp Time*	43	86	9999	Display value as is	min
Bakeout Current*	44	88	9999	Divide value by 10	A
Bakeout Off Time*	45	90	9999	Display value as is	min
Logging	46	92	0 = Off, 1 = On		
WiFi	47	94	0 = Off, 1 = On		

MSW = Most Significant Word, LSW = Least Significant Word

*Models with the current limit option

**DT2 and DT3 models

Modbus® RTU

This section describes communicating with an ASPYRE power controller via the Modbus® RTU communication protocol. The functionality is the same for port 1, which is included on all models and port 2, which is optional. The typical application for this protocol is using a programmable logic controller or other automation equipment to control the power controller.

Features

The ASPYRE power controller supports communication via Modbus® RTU with the features described below.

Message Format

The transmission format is:

- 1 start bit
- 8 data bits
- 2 stop bits (no parity)

Broadcast Messages

The ASPYRE power controller supports Modbus® RTU broadcast messages. Send broadcast messages using station address 0. All ASPYRE power controllers on the local area network act on the message contents without sending back any reply.

Supported Functions

The ASPYRE power controller supports the Modbus® RTU functions listed below. Note the limits to the number of registers that can be read and written with a single message from the host for each function.

Function	Description	Maximum Registers
03	Read the holding registers (40,001 to 49,999)	121
06	Write a single holding register	1
16	Write multiple holding registers	25

Communication Errors

Messages contain CRC error checking. If a message from the host fails the CRC test, or if the received message contains a syntax error, for example, the number of bytes or words is not correct, then the power controller will ignore the message.

If the received message is correct but contains an invalid value, the power controller sends responds with an error code. The supported error codes are listed in the table below.

Error Code	Description
1	Function code not supported
2	Incorrect data address
4	Too many registers (parameters) requested

Access Level

The ASPYRE power controller supports access to its parameters via the Modbus® RTU holding registers (40,001 to 49,999). The values of all the defined parameters may be read, some parameters are read-only and some parameters may be changed only after entering the correct password for the Access Level parameter.

Level zero (0) parameters do not require a password be entered. The level 1 password is "1111".

Which parameters are read-only and the access level or each parameter is indicated in table in the "Modbus® RTU Holding Registers" section below.

Modbus® RTU Holding Registers

The table below lists the parameters that may be read via Modbus® RTU via port 1 or if when the secondary communications option is Modbus® RTU via port 2.

For each parameter and the following information is listed:

- Parameter: the name of the parameter
- Register: the memory register that holds the parameter value
- Max: the maximum value of the parameter (the minimum is always zero.)
- Decoding: follow these instructions to display the value in the units of measurement
- Units: units of measurement
- RO: parameters marked with "RO" are read-only, all others allow reading and writing
- Level" Access level required to write a new value (not listed for read-only parameters)

For bitwise and enumerated parameters the decoding instructions span the Max, Decoding and Units columns.

Parameter	Register	Max	Decoding	Units	RO	Level
Access Level	1	65535	Display value as is	none		0
Port 2 Access	2	0 = Read and Write, 1 = Read Only				1
Frequency	9	65535	Divide value by 100	Hz	RO	
V Output	10	9999	Divide value by 10	V	RO	
I Output	11	9999	Divide value by 10	A	RO	

Parameter	Register	Max	Decoding	Units	RO	Level
Power	12	100	Display value as is	%	RO	
Status Bits	13		bit 0 = SCR short alarm (1) / no alarm (0) bit 1 = Heater break alarm (1) / no alarm (0) bit 2 = Output enable (1) / disabled (0) bit 4 = Current limit alarm (1) / no alarm (0) bit 5 = Thermal alarm (1) / no alarm (0) bit 6 = Communication alarm (1) / no alarm (0) bit 8 = Digital input 1 on (1) / off (0) bit 9 = Digital input 2 on (1) / off (0) bit 10 = Unbalanced alarm (1) / no alarm (0) bit 13 = phase loss alarm (1) / no alarm (0) bit 14 = Heater bakeout on (1) / off (0) bit 15 = Latched thermal alarm (1) / no alarm (0) (all others unused)			0
Command Bits	14		bit 1 = local (1) / remote (0) set point bit 2 = enable (1) / disable (0) output bit 4 = local (1) / remote (0) current limit (all others unused)			0
Set Point	15	1023	Divide value by 10.23	%		0
Out Scale	16	255	Divide value by 2.55	%		0
I Limit*	17	1023	Divide value by 10.23	%		0
Firing	18		1 = Zero Cross 2 = Single Cycle* 3 = Burst Fire 4 = Phase Angle* 10 = Half Cycle (DT1 only) 19 = Burst Fire Start Ramp* 20 = Phase Angle Soft Start* 35 = Burst Fire Delay Trigger* 74 = Half Cycle Safety Ramp (DT1 only) 99 = BF Strt Rmp Delay Trigger*			0
Feedback	19		0 = Voltage ² 1 = None 2 = Current ² 32 = Voltage 64 = Current 128 = Power 256 = External			0
Minimum Cycles	20	255	Display value as is	cycles		0
Half Cycle Delay	21	255	Display value as is	cycles		0
Delay	22	90	Display value as is	degrees		0
Soft Start	23	255	Display value as is	x50ms		0
Cycle Time	24	255	Display value as is	x50ms		0
Start Ramp	25	1023	Display value as is	half cycles		1
Prop Band Power	26	255	Display value as is	%		1
Integral Power	27	255	Display value as is	none		1
Htr Break Delay	28	255	Display value as is	x50ms		1
Htr Break Sensitivity	29	100	Display value as is	%		1
Port 1 Baud	30		0 = 9600, 1 = 19200, 2 = 38400, 3 = 115200			1

Parameter	Register	Max	Decoding	Units	RO	Level
Port 1 Address	31	255	Display value as is	none		1
Digital In 1 Function	32	0 = Enable 2 = Voltage Feedback 3 = Local / Remote 4 = Phase Angle* 5 = Set Point Analog In 1 / 2 6 = Logging 7 = Heater Bakeout*				1
Digital In 2 Function	33					1
Alarm Function	34	0 = None 1 = Heater Break (HB) 2 = SCR Short (SC) 3 = HB / SC 4 = I Limit* (IL) 5 = HB / IL* 6 = SC / IL* 7 = All (HB / SC / IL)* 16 = Watchdog (WD) 17 = WD / HB 18 = WD / SC 19 = WD / HB / SC 20 = WD / IL* 21 = WD / HB / IL* 22 = WD / SC / IL* 23 = WD / HB / SC / IL*				1
Unit Type	36	7 = 1 Leg, 8 = 2 Leg, 3 = 3 Leg (zero cross), 10 = 3 Leg (phase angle)			RO	
Nominal V	37	1023	Display value as is	V		0
Nominal I	38	9999	Divide value by 10	A		0
Max Voltage	41	1023	Display value as is	V	RO	
Aux Voltage	43	1023	Display value as is	V	RO	
Analog In 1 [Signal Type]	44	1 = 0-10V / 10k Pot, 2 = 4-20mA, 3 = 0-20mA				1
Port 2 Baud	45	0 = 9600, 1 = 19200, 2 = 38400, 3 = 115200				1
Load Ω	46	65535	Divide value by 100	Ohm	RO	0
V Input	47	65535	Divide value by 10	V	RO	
Version	48	65535	Display value as is	none	RO	
Release	49	65535	Display value as is	none	RO	
Limit Peak Current*	52	0 = RMS Current, 1 = Peak Current				0
Leg 1 I Output**	54	9999	Divide value by 10	A	RO	
Leg 2 I Output**	55	9999	Divide value by 10	A	RO	
Leg 3 I Output**	56	9999	Divide value by 10	A	RO	
Startup Display	60	0 = Current, 1 = Voltage, 2 = Power				1
Remote SP	61	0 = Analog In 1, 1 = Analog In 2				1
Max Current	62	9999	Divide value by 10	A		1
Prop Band Current*	63	255	Display value as is	%		1
Integral Current*	64	255	Display value as is	none		1
Safety Ramp Off Time	65	65535	Display value as is	x50ms		0
Safety Ramp Duration	66	65535	Display value as is	x50ms		0
Retransmit	68	0 = None, 10 = V Output, 11 = I Output, 12 = Power, 15 = Set Point				1
Retransmit Type	69	0 = 4-20mA, 1 = 0-10V, 2 = 0-20mA				1

Parameter	Register	Max	Decoding	Units	RO	Level
Logging Interval	70	255	Display value as is	seconds		1
Ethernet Address	71 to 74	255	Each register contains one of the four parts of the IP address or mask. Present as is delimited by dots.		RO	
Ethernet Subnet	75 to 78	255				
Ethernet Gateway	79 to 82	225				
Host Name	83 to 90	Two (one-byte) characters per register				1
DD/MM/YY	91	MSB = day; LSB = month				0
	92	MSB = year; LSB = hour				0
HH:MM:SS	93	MSB = minute; LSB = second				0
Wi-Fi Address	94 to 97	Each register contains one of the four parts of the IP address. Present as is delimited by dots.				0
Power Factor	102	1000	Divide value by 1000	ratio	RO	
Analog In 2 [Signal Type]	105	1 = 0-10V / 10k Pot, 2 = 4-20mA, 3 = 0-20mA				1
Analog In 2 Function	116	0 = I Limit*, 1 = Feedback, 2 = Set Point				1
Port 2	119	0 = Disabled, 1 = Ethernet, 2 = RS-485			RO	
WiFi	120	0 = Off, 1 = On				1
Port 2 Address [Profibus]	122	255	Display value as is	none		1
kW Real Time	123	9999	Display value as is	kW		0
Retransmit Scale	124	9999	Display value as is	varies		1
kW Total Least Significant Word	125	Combine for 32-bit, unsigned integer and divide by 10		kWh		0
kW Total Most Significant Word	126					0
SCR Temperature	127	0 = OK, 130 = Over Temp			RO	
kVA Real Time	131	65535	Divide value by 100	kVA		0
Analog In 2 [Value]	137	1023	Divide value by 10.23	%	RO	
Analog In 1 [Value]	138	1023	Divide value by 10.23	%	RO	
Logging	139	0 = Off, 1 = On				0
Heater Bakeout*	140	0 = Off, 1 = On				0
Watchdog	142	0 = Off, 1 = On				1
Watchdog Reset Time	143	255	Display value as is	seconds		1
Bakeout Ramp Time*	144	9999	Display value as is	min		1
Bakeout Current*	145	9999	Divide value by 10	A		1
Bakeout Off Time*	146	9999	Display value as is	min		1
Serial Number	149 to 152	Display the contents of each register			RO	
Thermal Alarm Counter	154	65535	Display value as is	none	RO	
Neutral Connected	156	0 = No Neutral, 1 = Neutral Connected				0

MSB = Most Significant Byte, LSB = Least Significant Byte

*Models with the current limit option

**DT2 and DT3 models

11

Specifications

Power Bases

- Single-phase, 1 controlled leg (2 SCR's)
- Three-phase, 2 controlled legs (4 SCR's)
- Three-phase, 3 controlled legs (6 SCR's)

Load Amp Range

- 35A to 700A @ 40°C ambient
- Amperage derating curve for other ambient temperatures
- Repetitive Peak Reverse Voltage (480V): 1200 Vimp
- Repetitive Peak Reverse Voltage (600V): 1600 Vimp
- Repetitive Peak Reverse Voltage (690V): 1800 Vimp

SCR and Amperage Rating

- Latching current: 1A minimum
- Power dissipation: approximate 1.25 to 1.5 watts per amp per controlled leg
- Leakage Current: 15mA
- SCCR rating 100,000A up to 600VAC

Line and Load Voltage Range

- 24 to 480V $\pm 10\%$ min./max.
- 24 to 600V $\pm 10\%$ min./max.
- 24 to 690V $\pm 10\%$ min./max.
- 690VAC only available on units $\geq 60A$
- Isolation Voltage: 3000VAC

Voltage Frequency

- 50 to 60Hz
- Automatically compensates for 47 to 70Hz

Amperage rating

Current (A)	SCR I ² T (A ² s)		
	Single Phase	2-Leg, 3-Phase	3-Leg, 3-Phase
300	125,000		
350			304,000
400	304,000		
450		304,000	1,050,000
500	1,050,000		
600	1,050,000		
700			

Controller Operating Supply Voltage

Nominal Line Voltage (VAC) RMS	Maximum Operating Range (VAC)
100/120	90 to 135
200/208/220/230/240	180 to 265
277	249 to 305
380/400/415/440/480	342 to 528
600	540 to 660
690	621 to 759

Feedback and Load Types

- Voltage, voltage squared, current, current squared, power, open loop and external
- All feedback types available with any firing type
- Normal resistive loads - nichrome, infrared lamps; medium and long waveform
- Others - Moly (Kanthal® Super), transformers, silicon carbide, UV lamps, tungsten

Output Control Firing

- Zero crossing
- Single cycle
- Burst firing with delayed triggering, safety ramp and peak current limit options
- Burst firing with start ramp option (phase angle at the beginning of each burst)
- Phase angle with soft start option
- Half cycle with start ramp and peak current limit options

Available Firing Type Combinations

Firing Type Combinations	Single Phase	3-Phase, 2-Leg	3-Phase, 3-Leg
Zero Crossing	X	X	X
Zero Crossing + Start Ramp	X		X
Zero Crossing + Start Ramp + Soft Start	X		X
Zero Crossing + Soft Start	X	X	X
Burst Firing	X	X	X
Burst Firing + Soft Start	X	X	X
Burst Firing + Start Ramp	X		X
Burst Firing + Start Ramp + Soft Start	X		X
Single Cycle	X		
Single Cycle + Soft Start	X		
Phase Angle	X		X
Phase Angle + Soft Start	X		X
Half Cycle	X		
Half Cycle + Soft Start	X		
Burst Firing + Delayed Triggering	X		X
Burst Firing + Delayed Triggering + Soft Start	X		X
Burst Firing + Delayed Triggering + Safety Ramp	X		X
Burst Firing + Delayed Triggering + Safety Ramp + Soft Start	X		X
Half Cycle + Safety Ramp	X		
Half Cycle + Safety Ramp + Peak Current Limit	X		

Current Limiting and Heater Bakeout

- Available on DT1 models and DT3 models 60A to 500A.

Digital Inputs 1 and 2

- On \geq 4VDC, Off \leq 1VDC
- 4 to 30VDC @ 5mA max.
- Optically isolated
- Digital Input functions: enable, change to voltage feedback, local/remote set point enable, change to phase angle firing, select analog input 1 or 2 for set point, enable data logging, enable heater bakeout
- A switched VDC control output can be connected to the digital input as an open loop control mode command signal

Analog Inputs 1 and 2

- Voltage: 0 to 10VDC, 15K Ω impedance
- Current: 0 to 20mA or 4 to 20mA, 100 Ω impedance
- Potentiometer: 10K Ω min.
- Analog Input 1 Function: Set point reference
- Analog Input 2 Functions: current limit, feedback or set point reference

Analog Output

- 0 to 20mA or 4 to 20mA into 500 Ω maximum load with 50 μ A nominal resolution
- 0 to 10VDC into a 500 Ω min. load with 50mV nominal resolution

Analog Output Function:

- Retransmit load voltage, current, power or set point
- If using analog retransmit and any Ethernet protocol or Profibus, an external power supply is required

Electromechanical Relay Output

- Form C, 30VDC max. at 1A resistive load or 0.5A at 125VAC, 6000 cycles at 30VDC, 100,000 cycles at 120VAC
- Relay Functions: alarm output options for heater open/break, SCR short, current limit and/or communications watchdog and SCR over-temperature

DC Power Supply for Digital Inputs and Potentiometer (for analog inputs)

- 10VDC @ 10mA maximum

Axiliary Power Input

- 8VA maximum

Diagnostic Messages

- Heater break (open), SCR shorted (closed), current limit, thermal switch, SD card error, communication watchdog error, bakeout in process, auxiliary voltage too low or high, voltage line loss

Configuration

- ASPYRE Configurator PC software via EIA-485 or USB, and on-board operator interface

Operator Interface

- 0.96 in. white OLED display with 128 x 64 pixel resolution
- Four buttons: local/remote (L/R), function (F) up arrow and down arrow
- Four indicators: local/remote mode, enable, communication and alarm

Cooling Mode

- Forced air (fan)
- 24 VDC, 120V or 240V
- 17W per fan, 34W (single-phase models), 68W (three-phase models.)

Control Terminals

- Terminals are touch safe, removable, 12 to 22 AWG

Line and Load Terminals

- Compatible with crimp lug terminals or busbar

Mounting

- Panel mounting with screws
- Must be mounted with heat sink fins in vertical orientation

Environment

- Ambient operating temperature: 0 to 40°C
- 5 to 95% RH (relative humidity), non-condensing
- Up to 6560 feet (2000m) above sea level maximum
- Over 1000 meters of altitude reduce the nominal current by 2% for each 100 meters
- Storage temperature -25 to 70°C max.
- Pollution degree: Installation Category III, Pollution degree 2
- Install away from direct sun light, conductive dust, corrosive gas, vibration, water and corrosive salts.

Total Heat Generated by ASPYRE Power Controller

Model	Current (A)	Switched Legs	Heat Loss (W)
DT1__-300...	300	1	443
DT1__-400...	400	1	547
DT1__-500...	500	1	591
DT1__-600...	600	1	832
DT1__-700...	700	1	945
DT2__-300...	300	2	903
DT3__-300...	300	3	1324
DT3__-350...	350	3	1439
DT2__-400...	400	2	1092
DT3__-400...	400	3	1641
DT2__-450...	450	2	1259
DT3__-450...	450	3	2096
DT2__-500...	500	2	1407
DT3__-500...	500	3	2096
DT2__-600...	600	2	1528
DT2__-700...	700	2	1753

Agency Approval and Regulatory

- cULus 508 Listed File E73741
- cUL® Listed to C22.2 No. 14
- CE EMC Directive 2014-30-EU, EN 60947-4-3 Class A Emissions
- CE Safety Directive 2014-35-EU, EN 60947-4-1, -4-3
- IP 20 with all covers in place
- RoHS 2011-65-EU
- W.E.E 2012-19-EU
- Utilization Category: AC-51, AC-55b, AC-56A
- Operation at ambient operating temperatures above 40°C not covered by UL®
- 690 VAC units not covered by UL®

Real time clock and battery back-up

- Typical battery life: 5 years at 77° F (25° C)
- CR2032 field replaceable battery

Connectivity

- Port 1: Modbus® RTU
- Port 2: Modbus® RTU, Modbus® TCP, EtherNet/IP™, PROFIBUS DP or PROFINET
- Wi-Fi
- USB 2.0 device
- If using analog retransmit and any Ethernet protocol or Profibus, an external power supply is required

Integrated Data Logging

- Storage: 16GB SD memory card
- File type: comma separated value (*.csv)
- User programmable logging intervals: 1 to 255 seconds
- Up to 10 parameters selectable by user: line frequency, output voltage (RMS), output current (RMS), output power (average), status, commands, set point, current limit set point (RMS), load resistance, input voltage (RMS)

Fusing

- Integrated semiconductor fuse
- Refer to replacement fuse table

Accessories

Free *ASPYPE Configurator* software at:

<http://www.watlow.com/en/resources-and-support/Technical-Library/Software-and-Demos>

6ft USB 2.0 type A to micro device cable (p/n 0219-0480-0000)

External 24VDC Power Supply

- Watlow power supply (p/n 0847-0299-0000) UL® Class 2, 90-263 VAC input, 24VDC output, 1.30A, 31W
- Phoenix Contact (p/n 2904371) UL® Class 2, 264 to 575 Vac input, 24 Vdc output 3.75A, 90W

Replacement Fuses

ASPYPE Model	Qty.	Fuse Part Numbers		
		Watlow	Cooper Bussman®	Siba
DT1__-300...	1	0808-0362-0000	350FM	
DT1__-400...	1	0808-0358-0000	550FMM	
DT1__-500...	1	0808-0359-0000	700FMM	
DT1__-600...	4	0808-0363-0250		20 559 20.250
DT1__-700...	4			

ASPYRE Model	Qty.	Fuse Part Numbers		
		Watlow	Cooper Bussman®	Siba
DT248-300...	3	0808-0357-0000	450FMM	
DT260-300...	3			
DT269-300...	3	2055-5072	400FMM	
DT2__-400...	3	0808-0358-0000	550FMM	
DT2__-450...	6	0808-0360-0000	315FM	
DT2__-500...	6			
DT2__-600...	4	0808-0357-0000	450FMM	
DT2__-700...	4			
DT348-300...	3			
DT360-300...	3			
DT369-300...	3	2055-5072	400FMM	
DT3__-350...	3	0808-0358-0000	550FMM	
DT3__-400...	3			
DT3__-450...	3	0808-0359-0000	700FMM	
DT3__-500...	3			

Declaration of Conformity

CE ASPYRE Series DT

WATLOW Electric Manufacturing Company.

1241 Bundy Blvd.
Winona, MN 55987 USA



Declares that the following ASPYRE Series DT

Model Numbers: DT (1, 2 or 3) (48, 60 or 69) – (035, 040, 060, 090, 120, 150, 180, 210, 300, 350, 400, 450, 500, 600 or 700)(1, 2, 3, 4, 5 or 6) (Any letter or number) – (0, 1, 2 or 3) (Any Number or letter)(A or C) (Any two number or letters)

Classification: Electric Power Control, Utilization Categories AC-51, AC-55b, AC-56a
Installation Category III, Pollution degree 2

Auxiliary Voltage and Frequency: Range 1 90 to 135 Vac~ 50/60 Hz
Range 2 180 to 265 Vac~ 50/60 Hz
Range 3 249 to 305 Vac~ 50/60 Hz
Range 4 342 to 528 Vac~ 50/60 Hz
Range 5 540 to 660 Vac~ 50/60 Hz
Range 6 540 to 759 Vac~ 50/60 Hz *not avail 035, 040 models

Load Voltage and Frequency: 24 to 480 Vac, 24 to 600 Vac or 24 to 690 Vac Options
50 or 60 Hz

Fan Power: 035, 040, 060 A models no fan*
*DT(1,2,3)(48,60)-(090-210) models use one fan per leg
110-120 Vac 50/60 Hz 15 watts per fan
220-240 Vac 50/60 Hz 16 watts per fan
24 Vdc 12 watts per fan
*DT1(48,60,69)-(300-700) models use two 17 watt fans.
*DT(2,3)(48,60,69)-(300-700) models use four 17 watt fans
*DT169-(060-210) models use one 17 watt fan
*DT(2,3)69-060 models use one 17 watt fan
*DT(2,3)69-(120-210) models use two 17 watt fans

Power Consumption: 8 VA Auxiliary Power,
Load Current based on model Maximum 35 to 700 Amps.
Models available in Single Phase, Three Phase 2 leg control or Three Phase 3 leg control.

Environmental Rating: IP20 with covers installed.

Meet the essential requirements of the following European Union Directives by using the relevant standards show below to indicate compliance.

2014/30/EU Electromagnetic Compatibility Directive

EN 60947-1 2007:A1 2011, A2 2014

Low Voltage Switchgear and Controlgear: Part 1 General Rules.

EN 60947-4-3 2014
EN 55011 2016:A1 2017

Part 4-3: Contactors and motor-starters - AC semiconductor controllers and contactors for non-motor loads
Industrial, scientific and medical equipment - Radio-frequency disturbance characteristics - Limits and methods of measurement

Class B Radiated Emissions, Class A Conducted Emissions. Group 1 Equipment.

CAUTION: This equipment not intended for use in residential environments and may not provide adequate protection to radio reception in such environments.

For use in Class B environments, additional filtering on power lines required.

For use with Phase Angle control, additional filtering required to pass Class A conducted Emissions. A Schaffner FN2080-16-06 was using in testing. A model with similar attenuation appropriate for currents involved will need to be selected in the end application or relaxed limits for > 20 kVA loads could be followed.

EN 61000-4-2:2009

Electrostatic discharge immunity

EN 61000-4-3:2006 +A1/2008, A2/2010

Radiated, radio-frequency electromagnetic field immunity, 10 V/m 80 MHz to 1 GHz 3 V/m 1.4 to 2 GHz, 1 V/m from 2 to 2.7 GHz.

EN 61000-4-4:2012

Electrical fast-transient / burst immunity

EN 61000-4-5:2014 +A1/2017

Surge immunity

EN 61000-4-6:2014 +

Immunity to conducted disturbances induced by radio-frequency fields 10 Vrms.

Corrigendum 2015

IEC 61000-4-11:2004 +

Voltage dips, short interruptions and voltage variations immunity

Interpretation 2010 +A1/2017

2014/35/EU Low-Voltage Directive

EN 60947-1 2007:A1 2011, A2 2014

Low Voltage Switchgear and Controlgear: Part 1 General Rules.

EN 60947-4-3 2014

Part 4-3: Contactors and motor-starters - AC semiconductor controllers and contactors for non-motor loads

Compliant with 2011/65/EU RoHS Directive

Per 2012/19/EU W.E.E Directive  Please Recycle Properly

Models DTXXX-XXXX-AXX(C or D)XX contain a type CR2032 lithium coin cell battery which shall be recycled at end of life per 2006/66/EC Battery Directive as amended by 2013/56/EU Directive.

Doug Kuchta

Name of Authorized Representative

Winona, Minnesota, USA

Place of Issue

Director of Operations

Title of Authorized Representative

February 2019

Date of Issue



Signature of Authorized Representative

How to Reach Us

Corporate Headquarters

Watlow Electric Manufacturing Company
12001 Lackland Road
St. Louis, MO 63146
Sales: 1-800-WATLOW2
Manufacturing Support: 1-800-4WATLOW
Email: info@watlow.com
Website: www.watlow.com
From outside the USA and Canada:
Tel: +1 (314) 878-4600
Fax: +1 (314) 878-6814

Latin America

Watlow de México S.A. de C.V.
Av. Fundición No. 5
Col. Parques Industriales
Querétaro, Qro. CP-76130
Mexico
Tel: +52 442 217-6235
Fax: +52 442 217-6403

Europe

Watlow Plasmatech GmbH
Brennhoflehan – Kellau 156
431 Kuchl
Austria
Tel: +3 0244 20129 0
Email: austria@watlow.com
Website: www.watlow.com

Watlow France
Tour d'Asnières.
4 Avenue Laurent Cély
92600 Asnières sur Seine
France
Tél: + 33 (0)1 41 32 79 70
Télécopie: + 33(0)1 47 33 36 57
Email: info@watlow.fr
Website: www.watlow.com

Watlow GmbH
Postfach 11 65, Lauchwasenstr. 1
D-76709 Kronau
Germany
Tel: +49 (0) 7253 9400-0
Fax: +49 (0) 7253 9400-900
Email: germany@watlow.de
Website: www.watlow.com

Watlow Italy S.r.l.
Viale Italia 52/54
20094 Corsico Milano
Italy
Tel: +39 024588841
Fax: +39 0245869954
Email: italyinfo@watlow.com
Website: www.watlow.com

Watlow Ibérica, S.L.U.
C/Marte 12, Posterior, Local 9
E-28850 Torrejón de Ardoz
Madrid - Spain
T. +34 91 675 12 92
F. +34 91 648 73 80
Email: info@watlow.es
Website: www.watlow.com

Watlow Ltd.
Roby Close, Linby Ind. Estate
Linby
NG15 8AA Nottingham
United Kingdom
Email: info@watlow.co.uk
Website: www.watlow.com
From outside The United Kingdom:
Tel: +44 (0) 115 964 0777
Fax: +44 (0) 115 964 0071

Asia and Pacific

Watlow Singapore Pte Ltd.
20 Kian Teck Lane, 4th Floor
Singapore 627854
Tel: +65 6773 9488
Fax: +65 6778 0323
Email: info@watlow.com.sg
Website: www.watlow.com.sg

瓦特隆电子科技 (上海) 有限公司
中国上海市
上海市杨浦区国定东路275-8号
绿地汇创1306室 200433
中国
本地 : 4006 Watlow (4006 928569)
国际 : +86-21-3532 8532
传真 : +86-21-3532 8568
电子邮件 : info-cn@watlow.com
网站 : www.watlow.com

Watlow Electric Manufacturing Company (Shanghai) Co. Ltd.
Greenland International Plaza Room 1306
275-8 East Guoding Road, Yangpu District
Shanghai 200433
China
Local Phone: 4006 Watlow (4006 928569)
International: +86 21 3381 0188
Fax: +86 21 6106 1423
Email: info-cn@watlow.com
Website: www.watlow.cn

Watlow Thermal Solutions India Pvt., Ltd.
401 Aarohan Plaza, 4th Floor
No. 6-3-678/1 Panjagutta
Hyderabad 500082 Telangana
India
Tel: +91-40-666 12700
Email: infoindia@watlow.com
Website: www.watlow.com

ワトロー・ジャパン株式会社
〒101-0047 東京都千代田区内神田1-14-4
四国ビル別館9階
Tel: 03-3518-6630
Fax: 03-3518-6632
Email: infoj@watlow.com
Website: www.watlow.co.jp

Watlow Japan Ltd.
Shikoku Building Annex 9th Floor
1-14-4 Uchikanda, Chiyoda-Ku
Tokyo 101-0047
Japan
Tel: +81-3-3518-6630
Fax: +81-3-3518-6632
Email: infoj@watlow.com
Website: www.watlow.co.jp

Watlow Korea Co., Ltd.
#2208, Hyundai KIC Building B, 70 Doosan-ro
Geumcheon-gu, Seoul
Republic of Korea
Tel: +82 (2) 2169-2600
Fax: +82 (2) 2169-2601
Website: www.watlow.co.kr

瓦特龍電機股份有限公司
80143 高雄市前金區七賢二路189號 10樓之一
電話: 07-2885168
傳真: 07-2885568
電子郵件: ryeh@watlow.com
網站: www.watlow.com

Watlow Electric Taiwan Corporation
10F-1 No.189 Chi-Shen 2nd Road Kaohsiung 80143
Taiwan
Tel: +886-7-2885168
Fax: +886-7-2885568
Email: ryeh@watlow.com
Website: www.watlow.com

