

- TRMS CLAMP-ON • AC CURRENT
AC VOLTAGE • DC CURRENT
DC VOLTAGE • THERMOCOUPLE
TEMP/RH • EVENT LOGGER

Simple Logger® II Data Loggers



Statement of Compliance

Chauvin Arnoux®, Inc. d.b.a. AEMC® Instruments certifies that this instrument has been calibrated using standards and instruments traceable to international standards.

We guarantee that at the time of shipping your instrument has met its published specifications.

An NIST traceable certificate may be requested at the time of purchase, or obtained by returning the instrument to our repair and calibration facility, for a nominal charge.

The recommended calibration interval for this instrument is 12 months and begins on the date of receipt by the customer. For recalibration, please use our calibration services. Refer to our repair and calibration section at www.aemc.com.

Serial #: _____

Catalog #: _____

Model #: _____

Please fill in the appropriate date as indicated:

Date Received: _____

Date Calibration Due: _____



AEMC[®]
INSTRUMENTS

Chauvin Arnoux®, Inc.
d.b.a AEMC® Instruments
www.aemc.com

Table of Contents





1. INTRODUCTION	4
1.1 Symbols Used.....	5
1.2 Definition of Measurement Categories	5
1.3 Receiving Your Shipment.....	6
1.4 Ordering Information	6
1.4.1 Recommended Probes: Models L101/L102/L562	7
1.4.2 Recommended Probes: Model L111	8
1.4.3 Accessories and Replacement Parts	8
2. PRODUCT FEATURES	9
2.1 Description.....	9
2.2 Control Features	10
2.2.1 Standard Models.....	10
2.2.2 Clamp-on Model CL601	12
3. SPECIFICATIONS	14
4. OPERATION.....	26
4.1 LED Control Operation and Status Function	26
4.2 Connecting the Simple Logger® II to a Computer	28
4.3 Recording Data	29
4.3.1 Starting a Recording Session	29
4.3.2 Stopping a Recording Session	30
4.4 Downloading Recorded Data	30
4.5 Clearing Alarm Indication.....	30
4.6 Erasing Data from Memory.....	31
4.7 Data Storage.....	32
4.7.1 Trend Measurements	32
4.8 Logger Operation.....	32
4.8.1 Recording with Memory Cleared	33
4.8.2 Recording with a Partial or Full Memory	33
4.8.3 Memory Filled During Recording Session	33
4.8.4 Batt. Power Insufficient for Full Record Duration	34

4.8.5	Recording Session has Ended	34
4.9	Event Logger Operation (Model L404)	35
4.9.1	Sample Event Capture.....	36
4.9.2	Application Examples	36
4.10	Reset Switch Operation	37
4.11	Flash Upgrade Switches.....	38
5.	SOFTWARE INSTALLATION	39
5.1	Installing DataView®.....	39
5.2	Data Logger Control Panel	41
6.	MAINTENANCE.....	42
6.1	Replacing the Batteries.....	42
6.2	Replacing the Fuse (Model L111)	43
6.3	Cleaning.....	43
APPENDIX A:	TROUBLESHOOTING	44
APPENDIX B:	GLOSSARY.....	45
Repair and Calibration		46
Technical and Sales Assistance		46
Limited Warranty		47
Warranty Repairs		47













INTRODUCTION

WARNING

These instruments comply with safety standard EN 61010-1 (Ed 2-2001) or EN 61010-2-032 (2002) for voltages and categories of installation, at an altitude below 2000m and indoors, with a degree of pollution at most equal to 2.

- Do not use in explosive atmosphere or in the presence of flammable gases or fumes.
- Do not use on voltage networks greater than categories mentioned above.
- Observe the maximum voltages and intensities assigned between terminals and earth.
- Do not use it if appears damaged, incomplete or improperly closed.
- Before each use, check the condition of the insulation of cables, case and accessories. Anything which appears damaged (even partially) must be reported for repair or scrapping.
- Use leads and accessories of voltages and categories at least equal to those of the instrument.
- Observe the environmental conditions of use.
- Use only recommended fuse.  Disconnect all leads before replacing the fuse (L111).
- Do not modify the instrument and use only original replacement parts. Repairs or adjustments must be performed by authorized personnel.
- Replace the batteries when the “Low Bat” LED is blinking.  Disconnect all cables from the instrument or remove the clamp on from the cable before opening the access door to the batteries.
-  Use protective equipment when security conditions are required.
-  Keep your hands away from unused terminals of the device.
-  When handling probes, probe tips, current sensors and alligators clips, keep fingers behind the guards.
- For measurements of dangerous voltages, first connect the black lead to the black terminal of the instrument and then connect this lead to the low voltage point of the source to measure (potential closer to Earth). Then connect the red lead to the red terminal of the instrument and connect the lead to the hot source to measure. Disconnection must be done respecting the reverse order, first disconnect the hot lead and then red then black lead.

1.1 Symbols Used

	Signifies that the instrument is protected by double or reinforced insulation.
	CAUTION - Risk of Danger! Indicates a WARNING and that the operator must refer to the user manual for instructions before operating the instrument in all cases where this symbol is marked.
	Risk of electric shock. The voltage at the parts marked with this symbol may be dangerous.
	Refers to a type A current sensor. This symbol signifies that application around and removal from HAZARDOUS LIVE conductors is permitted.
	Ground/Earth
	Important instructions to read and understand completely.
	Important information to acknowledge.
	Battery
	Fuse
	USB socket
	Compliance with the Low Voltage & Electromagnetic Compatibility European directives (73/23/CEE & 89/336/CEE)
	In the European Union, this product is subject to a separate collection system for recycling electrical and electronic components In accordance with directive WEEE 2002/96/EC

1.2 Definition of Measurement Categories

CAT II: For measurements performed on circuits directly connected to the electrical distribution system (AC supply wall outlet). Examples are measurements on household appliances or portable tools.

CAT III: For measurements performed in the building installation at the distribution level such as on hardwired equipment in fixed installation and circuit breakers.

CAT IV: For measurements performed at the primary electrical supply (< 1000V) such as on primary overcurrent protection devices, ripple control units, or meters.

1.3 Receiving Your Shipment

Upon receiving your shipment, make sure that the contents are consistent with the packing list. Notify your distributor of any missing items. If the equipment appears to be damaged, file a claim immediately with the carrier and notify your distributor at once, giving a detailed description of any damage. Save the damaged packing container to substantiate your claim.

1.4 Ordering Information

Simple Logger® II Model CL601 **Cat. #2126.01**
(1-Channel, TRMS Clamp-on 600AAC)

Includes USB cable, DataView® software, 2x1.5V AA-cell alkaline batteries and user manual.

Simple Logger® II Model L101 **Cat. #2126.02**
(1-Channel, TRMS 0 to 1VAC)

Includes a USB cable, DataView® software, 2x1.5V AA-cell alkaline batteries and user manual. Probes purchased separately.

Simple Logger® II Model L102 **Cat. #2126.03**
(2-Channel, TRMS 0 to 1VAC)

Includes a USB cable, DataView® software, 2x1.5V AA-cell alkaline batteries and user manual. Probes purchased separately.

Simple Logger® II Model L111 **Cat. #2126.04**
(1-Channel, TRMS 0 to 1AAC)

Includes a USB cable, DataView® software, 2x1.5V AA-cell alkaline batteries, one fuse 2A (250V) and user manual. Probes purchased separately.

Simple Logger® II Model L261 **Cat. #2126.05**
(1-Channel, TRMS 600VAC/DC)

Includes USB cable, DataView® software, 2x1.5V AA-cell alkaline batteries, one set of leads, one set of alligator clips and user manual.

Simple Logger® II Model L322 **Cat. #2126.06**
(2-Channel, 4 to 20mADC, Current)

Includes USB cable, one 4-position terminal block connector, DataView® software, 2x1.5V AA-cell alkaline batteries and user manual.

Simple Logger® II Model L404 **Cat. #2126.29**
(4-Channel, Event Logger)

Includes USB cable, one 8-position terminal block connector, DataView® software, 2x1.5V AA-cell alkaline batteries and user manual.

Simple Logger® II Model L432 **Cat. #2126.07**
(2-Channel, DC $\pm 100\text{mV}$ / 1V / 10VDC)
Includes USB cable, one 4-position terminal block connector, DataView® software, 2x1.5V AA alkaline batteries and user manual.

Simple Logger® II Model L481 **Cat. #2126.25**
(1-Channel, $\pm 850\text{VDC}$)
Includes USB cable, DataView® software, 2x1.5V AA alkaline batteries, one set of leads, one set of alligator clips and user manual.

Simple Logger® II Model L562 **Cat. #2126.35**
(2-Channel, TRMS 600V Voltage Input & 1V Current Probe Input)
Includes USB cable, DataView® software, 2x1.5V AA alkaline batteries, one set of leads, one set of alligator clips and user manual. Probes purchased separately.

Simple Logger® II Model L642 **Cat. #2126.08**
(2-Channel, Temperature Thermocouple)
Includes USB cable, Thermocouple - Flexible (1M), K Type, -58° to 480° F, DataView® software, 2x1.5V AA alkaline batteries and user manual.

Simple Logger® II Model L702 **Cat. #2126.09**
(2-Channel, Temp/RH Logger)
Includes USB cable, DataView® software, 2x1.5V AA alkaline batteries and user manual.

Simple Logger® II Model ML912 **Cat. #2126.37**
(2-Channel, TRMS, MiniFlex® 100/1000AAC)
Includes USB cable, DataView® software, 2x1.5V AA alkaline batteries and user manual.

1.4.1 Recommended Probes for Models L101, L102 & L562

AC Current Probe Model MN261
(24A-100mV/A, 240A-10mV/A, BNC) **Cat. #2115.82**

NOTE: The MN261 current probe should not be used on applications above 10 or 100 Amps (depending on range) when used with either the L101 or L102 data loggers. Clipping of the input signal could result.

AC Current Probe Model SR661
(10A-100mV/A, 100A-10mV/A, 1000A-1mV/A, BNC) **Cat. #2113.49**

AC Current Probe Model JM861
(30A-10mV/A, 300A-1mV/A, 3000A-0.1mV/A, BNC) **Cat. #2110.90**

AC Current Probe Model MN379
(5A-200mV/A; 100A-10mV/A, Lead) **Cat. #2153.01**

1.4.2 Recommended Probes for Model L111

AC Current Probe Model MN313 (150A, 1mA/A, Lead).....	Cat. #2116.25
AC Current Probe Model SR604 (1000A, 1mA/A, Lead)	Cat. #2113.44
AC Current Probe Model JM830A (3000A, .333mA/A, Lead)	Cat. #2110.83
AC Current Probe Model MN01 (150A, 1mA/A, Lead).....	Cat. #2129.17
AC Current Probe Model MN02 (100A, 1mA/A, Lead, 1% Accuracy)	Cat. #2129.20

1.4.3 Accessories and Replacement Parts

110V Outlet Adapter w/4mm Banana Plug	Cat. #2118.49
Thermocouple - Needle (12 x 5.9"), K Type, -58° to 1292° F (Model L642).....	Cat. #2126.46
Thermocouple - Flexible (1.2mm), K Type, -58° to 480° F (Model L642).....	Cat. #2126.47
Fuse - Set of 5, 2A (250V) FA (Model L111).....	Cat. #2126.48
Replacement - Type A to 5-pin mini-B 2M USB cable	Cat. #2126.49
Small Classic Carrying Bag	Cat. #2133.72
Lead - Set of 2, color-coded 5 ft w/color-coded alligator clips (Rated 600V CAT IV, 15A).....	Cat. #2140.62
Lead - Set of 2, color-coded 10 ft w/color-coded alligator clips (Rated 600V CAT IV, 15A).....	Cat. #2140.63

Order Accessories and Replacement Parts Directly Online

Check our Storefront at www.aemc.com/store for availability

PRODUCT FEATURES

2.1 Description

The Simple Logger® II Series include one and two channel recording devices (model dependent) powered by alkaline batteries. For AC units, line tracking is performed such that 64 samples over one line cycle are taken. Frequency tracking is performed over the range of ± 2 Hz around the nominal line frequency (50 or 60Hz). Harmonic measurements are calculated from these 64 samples (harmonics are only available from the Data Logger Control Panel within the DataView® software).

The Simple Logger® II records at a rate of up to eight times per second (model dependent). Samples are taken at a user defined storage rate. This means that the input(s) are ignored between measurement intervals.

Battery operation and compact size allows for installation in tight locations without the need for external power. A series of front panel LEDs provide a quick status of the logger's state and memory usage.

The main advantage of the logger is its ability to perform a variety of recording tasks with easy and intuitive setup from a computer using DataView® software.

Analog information on the input is sampled and converted to a digital value. This digital signal is processed and stored along with scale and time information. An optically isolated Universal Serial Bus (USB) port provides for the transfer of data from the instrument's internal memory to the computer for analysis.

2.2 Control Features

2.2.1 Standard Models

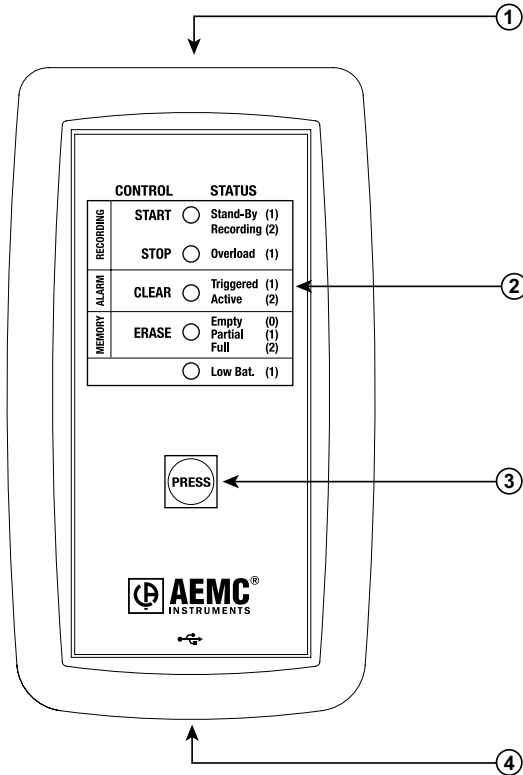

Figure 2-1

1. Input (model dependent)

L101/L102 - BNC Input Termination

L261/L481 - Two recessed 4mm safety banana jacks

L111 - Two recessed 4mm safety banana jacks and fuse location

L322/L432 - One 4-position removable screw-type terminal block

L404 - One 8-position removable screw-type terminal block

L562 - BNC/Two recessed 4mm safety banana jacks

L642 - Two miniature thermocouple connectors

L702 - Temp/RH Sensor

ML912 - Two captive MiniFlex® sensors

2. Five LED Indicators

The LEDs on the logger serve two functions: **Control Operation** and **Status Function**.

- The control operation (when holding down the PRESS button) is indicated with text to the left of each LED.
- The status function (when PRESS is not being held down) associated with each LED is indicated with text to the right of each LED.
- Refer to § 4.1 for detailed descriptions of each LED.

3. Control Button (PRESS)

This button marked “PRESS” selects the mode of operation. Use this button to start or stop recordings, erase the memory, clear alarms and turn the instrument ON/OFF.

4. Female Type Mini-B USB Connector

This connector is located on the bottom of the instrument.

5. Reset Switch (not shown)

The **RESET** switch resets the CPU. To access this switch, remove the battery compartment cover then remove the four screws holding the two halves of the case together. The reset switch is located on the exposed PCB near the inputs (refer to § 4.11).

6. Flash Upgrade Switches (not shown)

These two switches (accessible from under the top cover), the **RESET** switch and upgrade software are used to recover from a failed flash upgrade procedure (refer to § 4.12).



WARNING: If the **RESET** switch is pressed when the logger is recording, data in memory may be lost.

2.2.2 Clamp-on Model CL601

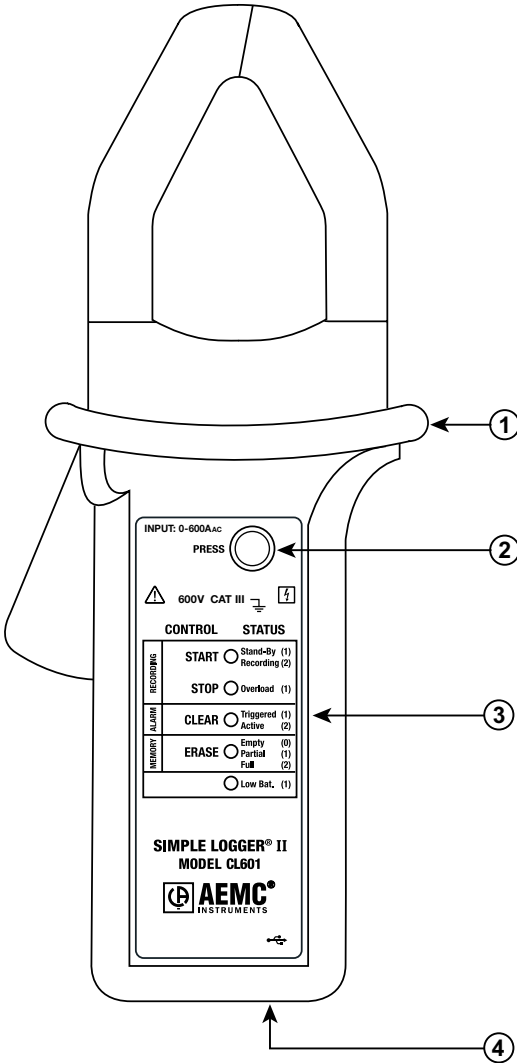

Figure 2-2

1. Safety barrier anti-slip guard

For safety purposes, always hold the probe under the guard.

2. Control Button (PRESS)

This button marked “PRESS” selects the mode of operation. Use this button to start or stop recordings, erase the memory and clear alarms.

3. Five LED Indicators

The LEDs on the instrument serve two functions: control operation and status function.

- The control operation (function when holding down the PRESS button) is indicated with text to the left of each LED.
- The status function (function when PRESS is not being held down) associated with each LED is indicated with text to the right of each LED.
- Refer to § 4.1 for detailed descriptions of each LED.

4. Female Type Mini-B USB Connector

5. Reset Switch (not shown)

The **RESET** switch resets the CPU. To access the switch, remove the battery compartment cover. The switch is located at the top left of the battery compartment (refer to § 4.11).

6. Flash Upgrade Switches (not shown)

These two switches (accessible from under the battery compartment), the **RESET** switch and upgrade software are used to recover from a failed flash upgrade procedure (refer to § 4.12).



WARNING: If the **RESET** switch is pressed when the logger is recording, data in memory may be lost.

CHAPTER 3

SPECIFICATIONS

Reference Conditions: 23°C ± 3°C, 30-50% RH, DC or 50/60 Hz, no AC external magnetic field, DC magnetic field ≤ 40A/m, centered conductor, battery voltage: 3V ± 10%.

MODEL	L101	L102
ELECTRICAL		
Channels	One	Two
Input	BNC	
Input Level	0 to 1V _{AC}	
Accuracy (50/60Hz)	0 to 10mV unspecified 10 to 50mV: ±(0.5% of Reading +1mV) 50 to 1000mV: ±(0.5% of Reading +0.5mV)	
Resolution	0.1mV _{AC}	
Maximum Input Voltage***	5V _{rms} or ± 7.07V _{PEAK}	
Input Impedance	800kΩ	
Sample Rate	64 samples/cycle	
Storage Rate	Programmable from 125ms to 1 per day	
Storage Modes	Start/Stop, FIFO and Extended Recording Mode* (XRM™), Alarm	
Recording Length	15 minutes to 8 weeks, programmable using DataView®	
Memory	240,000 measurement (512kB). Recorded data is stored in non-volatile memory and retained even if battery is low or removed.	
Communication	USB 2.0 optically isolated	
Power Source**	2x1.5V AA (LR6) alkaline batteries	
Battery Life	100 hrs to >45 days (dependent on storage rate/recording length)	
MECHANICAL		
Dimensions	5.38 x 2.75 x 1.28" (136 x 70 x 32mm)	
Weight (with battery)	6.4 oz (180g)	
Case	UL94-V0	
Vibration	IEC 68-2-6 (1.5mm, 10 to 55Hz)	
Shock	IEC 68-2-27 (30G)	
Drop	IEC 68-2-32 (1m)	
ENVIRONMENTAL		
Operating Temperature	14° to 122°F (-10° to 50°C)	
Storage Temperature	-4° to 140°F (-20° to 60°C)	
Relative Humidity	Up to 85% at 95°F (35°C), Non-condensing	
Altitude	2000m	
SAFETY & ELECTRO-MAGNETIC COMPATIBILITY		
Safety Rating	EN 61010-1; 50V CAT III; Pollution Degree 2	
Protection Degree	IP40	
Electro-Magnetic Compatibility	EN 61326-1; 07/1997 (+A1 10/1998, +A2 09/2001, +A3 05/2004)	
CE Approved	Yes	

MODEL	L111
ELECTRICAL	
Channels	One
Input	Two recessed banana jacks
Input Level	0 to 1Aac
Accuracy (50/60Hz)	0 to 10mA unspecified 10 to 50mA: $\pm(0.5\%$ of Reading +1mA) 50 to 1000mA: $\pm(0.5\%$ of Reading +0.5mA)
Resolution	0.1mA
Maximum Input Current***	1.2A
Input Impedance	1 Ω
Sample Rate	64 samples/cycle
Storage Rate	Programmable from 125ms to 1 per day
Storage Modes	Start/Stop, FIFO and Extended Recording Mode* (XRM™), Alarm
Recording Length	15 minutes to 8 weeks, programmable using DataView®
Memory	240,000 measurement (512kB). Recorded data is stored in non-volatile memory and retained even if battery is low or removed.
Communication	USB 2.0 optically isolated
Fuse	2A FA 250V 5x20mm
Power Source**	2x1.5V AA (LR6) alkaline batteries
Battery Life	100 hours to >45 days (dependent on storage rate/recording length)
MECHANICAL	
Dimensions	5.18 x 2.75 x 1.28" (132 x 70 x 32mm)
Weight (with battery)	6.64 oz (188g)
Case	UL94-V0
Vibration	IEC 68-2-6 (1.5mm, 10 to 55Hz)
Shock	IEC 68-2-27 (30G)
Drop	IEC 68-2-32 (1m)
ENVIRONMENTAL	
Operating Temperature	14° to 122°F (-10° to 50°C)
Storage Temperature	-4° to 140°F (-20° to 60°C)
Relative Humidity	Up to 85% at 95°F (35°C), Non-condensing
Altitude	2000m
SAFETY & ELECTRO-MAGNETIC COMPATIBILITY	
Safety Rating	EN 61010-1; 50V CAT III; Pollution Degree 2
Protection Degree	IP40
Electro-Magnetic Compatibility	EN 61326-1; 07/1997 (+A1 10/1998, +A2 09/2001, +A3 05/2004)
CE Approved	Yes

MODEL	L261
ELECTRICAL	
Channels	One
Input	Two recessed 4mm safety banana jacks
Input Level	0 to 600V _{AC/DC}
Accuracy (50/60Hz)	0 to 5V: unspecified 5 to 50V: ±(0.5% of Reading +1V) 50 to 600V: ±(0.5% of Reading +0.5V)
Resolution	0.1V
Maximum Input Voltage***	1.2 x 600V
Input Impedance	40MΩ
Sample Rate	64 samples/cycle
Storage Rate	Programmable from 125ms to 1 per day
Storage Modes	Start/Stop, FIFO and Extended Recording Mode* (XRM™), Alarm
Recording Length	15 minutes to 8 weeks, programmable using DataView®
Memory	240,000 measurement (512KB). Recorded data is stored in non-volatile memory and retained even if battery is low or removed.
Communication	USB 2.0 optically isolated
Power Source**	2x1.5V AA (LR6) alkaline batteries
Battery Life	100 hours to >45 days (dependent on storage rate/recording length)
MECHANICAL	
Dimensions	4.94 x 2.75 x 1.28" (125 x 70 x 32mm)
Weight (with battery)	6.4 oz (180g)
Case	UL94-V0
Vibration	IEC 68-2-6 (1.5mm, 10 to 55Hz)
Shock	IEC 68-2-27 (30G)
Drop	IEC 68-2-32 (1m)
ENVIRONMENTAL	
Operating Temperature	14° to 122°F (-10° to 50°C)
Storage Temperature	-4° to 140°F (-20° to 60°C)
Relative Humidity	Up to 85% at 95°F (35°C), Non-condensing
Altitude	2000m
SAFETY & ELECTRO-MAGNETIC COMPATIBILITY	
Safety Rating	EN61010-1; 600V CAT III, 300V CAT IV; Pollution Degree 2
Protection Degree	IP40
Electro-Magnetic Compatibility	EN 61326-1; 07/1997 (+A1 10/1998, +A2 09/2001, +A3 05/2004)
CE Approved	Yes

MODEL	L322
ELECTRICAL	
Channels	Two
Input	One 4-position removable screw-type terminal block
Input Level	-20mAdc to +20mAdc
Accuracy	(0.25% of Reading +0.05mA)
Resolution	0.01mA
Maximum Input Current***	±24mAdc
Input Impedance	50Ω
Sample Rate	Maximum of 8 samples taken at storage interval
Storage Rate	Programmable from 125ms to 1 per day
Storage Modes	Start/Stop, FIFO and Extended Recording Mode* (XRM™), Alarm
Recording Length	15 minutes to 8 weeks, programmable using DataView®
Memory	240,000 measurement (512KB). Recorded data is stored in non-volatile memory and retained even if battery is low or removed.
Communication	USB 2.0 optically isolated
Power Source**	2x1.5V AA (LR6) alkaline batteries
Battery Life	100 hours to >45 days (dependent on storage rate/recording length)
MECHANICAL	
Dimensions	5.45 x 2.75 x 1.28" (136 x 70 x 32mm)
Weight (with battery)	6.4 oz (181g)
Case	UL94-V0
Vibration	IEC 68-2-6 (1.5mm, 10 to 55Hz)
Shock	IEC 68-2-27 (30G)
Drop	IEC 68-2-32 (1m)
ENVIRONMENTAL	
Operating Temperature	14° to 122°F (-10° to 50°C)
Storage Temperature	-4° to 140°F (-20° to 60°C)
Relative Humidity	Up to 85% at 95°F (35°C), Non-condensing
Altitude	2000m
SAFETY & ELECTRO-MAGNETIC COMPATIBILITY	
Safety Rating	EN 61010-1; 50V CAT III; Pollution Degree 2
Protection Degree	IP40
Electro-Magnetic Compatibility	EN 61326-1; 07/1997 (+A1 10/1998, +A2 09/2001, +A3 05/2004)
CE Approved	Yes

MODEL	L404
ELECTRICAL	
Channels	Four
Input	One 8-position removable screw-type terminal block
Input Level	Contact closure, 0 to 5V
Maximum Input Voltage***	10V _{dc}
Input Impedance	> 150K Ω
Sample Rate	Maximum of 8 per second
Storage Rate	Maximum once every two sample periods (event dependent)
Storage Mode	Event Recording ⁽¹⁾
Recording Length	15 minutes to 8 weeks, programmable using DataView®
Memory	50,000 events (512KB). Recorded data is stored in non-volatile memory and retained even if battery is low or removed.
Communication	USB 2.0 optically isolated
Power Source**	2x1.5V AA (LR6) alkaline batteries
Battery Life	100 hours to >45 days (dependent on storage rate/recording length)
MECHANICAL	
Dimensions	5.45 x 2.75 x 1.28" (136 x 70 x 32mm)
Weight (with battery)	6.4 oz (181g)
Case	Polycarbonate UL94-V0
Vibration	IEC 68-2-6 (1.5mm, 10 to 55Hz)
Shock	IEC 68-2-27 (30G)
Drop	IEC 68-2-32 (1m)
ENVIRONMENTAL	
Operating Temperature	14° to 122°F (-10° to 50°C)
Storage Temperature	-4° to 140°F (-20° to 60°C)
Relative Humidity	Up to 85% at 95°F (35°C), Non-condensing
Altitude	2000m
SAFETY & ELECTRO-MAGNETIC COMPATIBILITY	
Safety Rating	EN 61010-1; 50V CAT III; Pollution Degree 2
Protection Degree	IP40
CE Approved	Yes

(1) This recording mode stores the time and duration of the event, and the channel the event occurred on. An event occurs when the input falls below 0.7V and ends when it rises above 0.8V. An internal pull up is provided for contact closure.

MODEL	L432
ELECTRICAL	
Channels	Two
Input	One 4-position removable screw-type terminal block
Input Level (3 ranges/channel)	Range 1: -100mV to 100mVdc Range 2: -1V to 1Vdc Range 3: -10V to 10Vdc
Accuracy	Range 1: $\pm(0.5\%$ of Reading +1mV) Range 2: $\pm(0.5\%$ of Reading +1mV) Range 3: $\pm(0.5\%$ of Reading +10mV)
Resolution	Range 1: 0.1mV Range 2: 1mV Range 3: 10mV
Maximum Input Voltage***	$\pm(1.2 \times \text{Nominal Range})$
Input Impedance	100mV/1V: 80k Ω ; 10V: 800k Ω
Sample Rate	Maximum of 8 samples taken at storage interval
Storage Rate	Programmable from 125ms to 1 per day
Storage Modes	Start/Stop, FIFO and Extended Recording Mode* (XRM™), Alarm
Recording Length	15 minutes to 8 weeks, programmable using DataView®
Memory	240,000 measurement (512KB). Recorded data is stored in non-volatile memory and retained even if battery is low or removed.
Communication	USB 2.0 optically isolated
Power Source**	2x1.5V AA (LR6) alkaline batteries
Battery Life	100 hours to >45 days (dependent on storage rate/recording length)
MECHANICAL	
Dimensions	5.45 x 2.75 x 1.28" (136 x 70 x 32mm)
Weight (with battery)	6.4 oz (181g)
Case	UL94-V0
Vibration	IEC 68-2-6 (1.5mm, 10 to 55Hz)
Shock	IEC 68-2-27 (30G)
Drop	IEC 68-2-32 (1m)
ENVIRONMENTAL	
Operating Temperature	14° to 122°F (-10° to 50°C)
Storage Temperature	-4° to 140°F (-20° to 60°C)
Relative Humidity	Up to 85% at 95°F (35°C), Non-condensing
Altitude	2000m
SAFETY & ELECTRO-MAGNETIC COMPATIBILITY	
Safety Rating	EN 61010-1; 50V CAT III; Pollution Degree 2
Protection Degree	IP40
Electro-Magnetic Compatibility	EN 61326-1; 07/1997 (+A1 10/1998, +A2 09/2001, +A3 05/2004)
CE Approved	Yes

MODEL	L481
ELECTRICAL	
Channels	One
Input	Two recessed 4mm safety banana jacks
Input Level	-850Vdc to +850Vdc
Accuracy (50/60Hz)	0 to 5V: unspecified 5 to 50V: $\pm(0.5\%$ of Reading +1V) 50 to 850V: $\pm(0.5\%$ of Reading +0.5V)
Resolution	0.1V
Maximum Input Voltage***	$\pm 1020Vdc$
Input Impedance	40M Ω
Sample Rate	Maximum of 8 per second
Storage Rate	Programmable from 125ms to 1 per day
Storage Modes	Start/Stop, FIFO and Extended Recording Mode* (XRM™), Alarm
Recording Length	15 minutes to 8 weeks, programmable using DataView®
Memory	240,000 measurement (512KB). Recorded data is stored in non-volatile memory and retained even if battery is low or removed.
Communication	USB 2.0 optically isolated
Power Source**	2x1.5V AA (LR6) alkaline batteries
Battery Life	100 hours to >45 days (dependent on storage rate/recording length)
MECHANICAL	
Dimensions	4.94 x 2.75 x 1.28" (125 x 70 x 32mm)
Weight (with battery)	6.4 oz (180g)
Case	UL94-V0
Vibration	IEC 68-2-6 (1.5mm, 10 to 55Hz)
Shock	IEC 68-2-27 (30G)
Drop	IEC 68-2-32 (1m)
ENVIRONMENTAL	
Operating Temperature	14° to 122°F (-10° to 50°C)
Storage Temperature	-4° to 140°F (-20° to 60°C)
Relative Humidity	Up to 85% at 95°F (35°C), Non-condensing
Altitude	2000m
SAFETY & ELECTRO-MAGNETIC COMPATIBILITY	
Safety Rating	EN61010-1; 600V CAT III, 300V CAT IV; Pollution Degree 2
Protection Degree	IP40
CE Approved	Yes

MODEL	L562	
ELECTRICAL		
Channels	Two	
Connection	Current Channel	Voltage Channel
Input	BNC	Two recessed banana jacks
Input Level	0 to 1V (for use with current probes with a voltage output)	0 to 600V _{AC}
Accuracy (50/60Hz)	0 to 10mV unspecified 10 to 50mV: ±(0.5% of Reading + 1mV) 50 to 1000mV: ±(0.5% of Reading + 0.5mV)	0 to 5V unspecified 5 to 50V: ±(0.5% of Reading + 1V) 50 to 600V: ±(0.5% of Reading + 0.5V)
Resolution	0.1mV	0.1V
Maximum Input Voltage***	5V _{rms} or ± 7.07V _{PEAK}	1.2 x 600V
Input Impedance	800k Ω	40M Ω
Sample Rate	64 samples/cycle	
Storage Rate	Programmable from 125ms to 1 per day	
Storage Modes	Start/Stop, FIFO and Extended Recording Mode* (XRM™), Alarm	
Recording Length	15 minutes to 8 weeks, programmable using DataView®	
Memory	240,000 measurements (512KB). Recorded data is stored in non-volatile memory and retained even if battery is low or removed.	
Communication	USB 2.0 optically isolated	
Power Source**	2x1.5V AA-cell alkaline batteries	
Battery Life	100 hours to >45 days (dependent on storage rate/recording length)	
MECHANICAL		
Dimensions	5.38 x 2.75 x 1.28" (136 x 70 x 32mm)	
Weight (with battery)	6.4 oz (180g)	
Case	UL94-V0	
Vibration	IEC 68-2-6 (1.5mm, 10 to 55Hz)	
Shock	IEC 68-2-27 (30G)	
Drop	IEC 68-2-32 (1m)	
ENVIRONMENTAL		
Operating Temperature	14° to 122°F (-10° to 50°C)	
Storage Temperature	-4° to 140°F (-20° to 60°C)	
Relative Humidity	Up to 85% at 95°F (35°C), Non-condensing	
Altitude	2000m	
SAFETY & ELECTRO-MAGNETIC COMPATIBILITY		
Safety Rating	EN61010-1; 600V CAT III, 300V CAT IV; Pollution Degree 2	
Protection Degree	IP40	
Electro-Magnetic Compatibility	EN 61326-1; 07/1997 (+A1 10/1998, +A2 09/2001, +A3 05/2004)	
CE Approved	Yes	

MODEL	L642			
ELECTRICAL				
Channels	Two			
Input	Two miniature thermocouple connectors			
Measurement Range: (thermocouple dependent)	°F	°C		
	J	-346 to +2192	J	-210 to +1200
	K	-328 to +2501	K	-200 to +1372
	T	-328 to +752	T	-200 to +400
	N	-328 to +2372	N	-200 to +1300
	E	-238 to 1742	E	-150 to +950
	R	32 to 3212	R	0 to 1767
S	32 to 3212	S	0 to 1767	
Resolution	$\theta < 1000^{\circ}\text{F}$ or $^{\circ}\text{C} \rightarrow 0.1^{\circ}\text{F}$ or $^{\circ}\text{C}$ $\theta \geq 1000^{\circ}\text{F}$ or $^{\circ}\text{C} \rightarrow 1^{\circ}\text{F}$ or $^{\circ}\text{C}$			
Accuracy (J, K, T, N, E)	$\theta \leq -148^{\circ}\text{F}/-100^{\circ}\text{C} \rightarrow \pm (0.2\% \text{ of Reading} + 1.1^{\circ}\text{F}/0.6^{\circ}\text{C})$ $-148^{\circ}\text{F}/-100^{\circ}\text{C} < \theta \leq +212^{\circ}\text{F}/+100^{\circ}\text{C} \rightarrow$ $\pm (0.15\% \text{ of Reading} + 1.1^{\circ}\text{F}/0.6^{\circ}\text{C})$ $\theta > +212^{\circ}\text{F}/+100^{\circ}\text{C} \rightarrow \pm (0.1\% \text{ of Reading} + 1.1^{\circ}\text{F}/0.6^{\circ}\text{C})$			
Accuracy (R, S)	$\theta = 32^{\circ}\text{F}/0^{\circ}\text{C}$ to $+212^{\circ}\text{F}/+100^{\circ}\text{C} \rightarrow$ $\pm (0.15\% \text{ of Reading} + 1.8^{\circ}\text{F}/1.0^{\circ}\text{C})$ $\theta > +212^{\circ}\text{F}/+100^{\circ}\text{C} \rightarrow \pm (0.1\% \text{ of Reading} + 1.8^{\circ}\text{F}/1.0^{\circ}\text{C})$			
Temperature Coefficient:	$\pm (0.02\% \text{ of Reading} + 0.03^{\circ}\text{C})/^{\circ}\text{C}$ or $\pm (0.02\% \text{ of Reading} + 0.03^{\circ}\text{F})/^{\circ}\text{F}$ between operating temperature of -10°C to $+18^{\circ}\text{C}$ and $+28^{\circ}\text{C}$ to $+50^{\circ}\text{C}$			
Maximum Differential Voltage	1V (between inputs)			
Sample Rate	Maximum of 8 samples taken at storage interval			
Storage Rate	Programmable from 5 seconds to 1 per day			
Storage Modes	Start/Stop, FIFO and Extended Recording Mode* (XRM™), Alarm			
Recording Length	15 minutes to 8 weeks, programmable using DataView®			
Memory	240,000 measurement (512 KB). Recorded data is stored in non-volatile memory and retained even if battery is low or removed.			
Communication	USB 2.0 optically isolated			
Power Source**	2x1.5V AA (LR6) alkaline batteries			
Battery Life	100 hours to >45 days (dependent on storage rate/recording length)			
MECHANICAL				
Dimensions	4.94 x 2.75 x 1.28" (125 x 70 x 32mm)			
Weight (with battery)	7 oz (200g)			
Case	UL94-V0			
Vibration	IEC 68-2-6 (1.5mm, 10 to 55Hz)			
Shock	IEC 68-2-27 (30G)			
Drop	IEC 68-2-32 (1m)			
ENVIRONMENTAL				
Operating Temperature	14° to 122°F (-10° to 50°C)			
Storage Temperature	-4° to 140°F (-20° to 60°C)			
Relative Humidity	Up to 85% at 95°F (35°C), Non-condensing			
Altitude	2000m			
SAFETY & ELECTRO-MAGNETIC COMPATIBILITY				
Safety Rating	EN61010-1; 50V CAT III; Pollution Degree 2			
Protection Degree	IP40			
CE Approved	Yes			

MODEL	L702	
ELECTRICAL		
Channels	Two	
Input	Temperature Sensor	Humidity Sensor
Range	14° to 122°F (-10° to 50°C)	5 to 85% RH
Accuracy	± (1% of Reading + 1°F/C)	± (3% of Reading + 2cts)
Resolution	0.1 °F/C	0.1% RH
Sample Rate	Maximum of 1 every 5 seconds	
Storage Rate	Programmable from once every 5s to 1 per day	
Storage Modes	Start/Stop, FIFO and Extended Recording Mode* (XRM™), Alarm	
Recording Length	15 minutes to 8 weeks, programmable using DataView®	
Memory	240,000 measurements (512KB). Recorded data is stored in non-volatile memory and retained even if battery is low or removed.	
Communication	USB 2.0 optically isolated	
Power Source**	2x1.5V AA-cell alkaline batteries	
Battery Life	100 hours to >45 days (dependent on storage rate/recording length)	
MECHANICAL		
Dimensions	4.94 x 2.75 x 1.28" (136 x 70 x 32mm) w/o Sensor	
Weight (with battery)	6.4 oz (180g)	
Case	UL94-V0	
Vibration	IEC 68-2-6 (1.5mm, 10 to 55Hz)	
Shock	IEC 68-2-27 (30G)	
Drop	IEC 68-2-32 (1m)	
ENVIRONMENTAL		
Operating Temperature	14° to 122°F (-10° to 50°C)	
Storage Temperature	-4° to 140°F (-20° to 60°C)	
Relative Humidity	Up to 85% at 95°F (35°C), Non-condensing	
Altitude	2000m	
SAFETY & ELECTRO-MAGNETIC COMPATIBILITY		
Safety Rating	EN61010-1; 50V CAT III; Pollution Degree 2	
Protection Degree	IP40	
CE Approved	Yes	

MODEL	ML912	
ELECTRICAL		
Channels	Two	
Input	Captive MiniFlex® AC Current Flexible Sensors	
Range	0.5 to 100Aac	5 to 1000Aac
Accuracy (50/60Hz)	0 to 1A unspecified 1 to 100A: ±(1% of Reading + 0.5A)	0 to 5A unspecified 5 to 1000A: ±(1% of Reading + 1A)
Resolution	0.1A	
Sample Rate	64 samples/cycle	
Storage Rate	Programmable from 125ms to 1 day	
Storage Modes	Start/Stop, FIFO and Extended Recording Mode* (XRM™), Alarm	
Recording Length	15 minutes to 8 weeks, programmable using DataView®	
Memory	240,000 measurements (512KB). Recorded data is stored in non-volatile memory and retained even if battery is low or removed.	
Communication	USB 2.0 optically isolated	
Power Source**	2x1.5V AA-cell alkaline batteries	
Battery Life	100 hours to >45 days (dependent on storage rate/recording length)	
MECHANICAL		
Dimensions	4.95 x 2.75 x 1.28" (136 x 70 x 32mm) w/o Sensor	
Weight (with battery)	8.67 oz (245g)	
Sensor/Cable Length	Sensor: 6" (152mm) / Cable: 6 ft (2m)	
Maximum Conductor Size	Ø 1.77" (45mm)	
Case	UL94-V0	
Vibration	IEC 68-2-6 (1.5mm, 10 to 55Hz)	
Shock	IEC 68-2-27 (30G)	
Drop	IEC 68-2-32 (1m)	
ENVIRONMENTAL		
Operating Temperature	14° to 122°F (-10° to 50°C)	
Storage Temperature	-4° to 140°F (-20° to 60°C)	
Relative Humidity	Up to 85% at 95°F (35°C), Non-condensing	
Altitude	2000m	
SAFETY & ELECTRO-MAGNETIC COMPATIBILITY		
Safety Rating	EN61010-1; 600V CAT IV, 1000V CAT III; Pollution Degree 2	
Protection Degree	IP40	
Electro-Magnetic Compatibility	EN 61326-1; 07/1997 (+A1 10/1998, +A2 09/2001, +A3 05/2004)	
CE Approved	Yes	

MODEL	CL601
ELECTRICAL	
Channels	One
Input	Split CT – AC Current
Input Level	0 to 600Aac
Accuracy (50/60Hz)	0 to 5A: Unspecified 5 to 50A: $\pm(1\% \text{ of Reading} + 1A)$ 50 to 400A: $\pm(1\% \text{ of Reading} + 0.5A)$ 400 to 600A for duration $<10\text{min}$: $\pm(3\% \text{ of Reading} + 1A)$
Resolution	0.1A
Maximum Input Current***	600A $< 1 \text{ min}$
Sample Rate	64 samples/cycle
Storage Rate	Programmable from Recording to 1 per day
Storage Modes	Start/Stop, FIFO and Extended Recording Mode* (XRM™), Alarm
Recording Length	15 minutes to 8 weeks, programmable using DataView®
Memory	240,000 measurement (512KB). Recorded data is stored in non-volatile memory and will be retained even if battery is low or removed.
Communication	USB 2.0 optically isolated
Power Source**	2x1.5V AA (LR6) alkaline batteries
Battery Life	100 hours to $>45 \text{ days}$ (dependent on sample rate/recording length)
MECHANICAL	
Dimensions	9.25 x 4.0 x 1.63" (235 x 102 x 41mm)
Weight (with battery)	17.1 oz (485g)
Case	Polycarbonate UL94-V0
Jaw Opening	1 conductor - $\emptyset 1.42"$ (36mm); 2 conductors - $\emptyset 1.00"$ (25mm) each 2 bus bars - 50 x 5mm
Vibration	IEC 68-2-6 (1.5mm 10 to 55Hz)
Shock	IEC 68-2-27 (30G)
Drop	IEC 68-2-32 (1m)
ENVIRONMENTAL	
Operating Temperature	14° to 122°F (-10° to 50°C)
Storage Temperature	-4° to 140°F (-20° to 60°C)
Relative Humidity	up to 85% at 95°F (35°C), Non-condensing
Altitude	2000m
SAFETY & ELECTRO-MAGNETIC COMPATIBILITY	
Safety Rating	EN 61010-2-032; 300V CAT IV, 600V CAT III; Pollution Degree 2
Protection Degree	IP40
Electro-Magnetic Compatibility	EN 61326-1; 07/1997 (+A1 10/1998, +A2 09/2001, +A3 05/2004)
CE Approved	Yes

*This unique recording mode provides the opportunity to continuously record over long periods of time by reducing the storage resolution of the stored data and maintaining matching resolution for the newest data. Each time the memory fills up using XRM™, every other of the oldest stored samples is discarded making room for newer samples. This process continues until the recording is manually stopped.

**A memory backup capacitor provides backup power while the batteries are being changed. This backup capacitor will maintain the instrument for up to 10 seconds without batteries installed. After 10 seconds the date and time will need to be reset (data and configuration will be maintained). If the unit is connected to DataView® via a PC, the battery life is 100 hours regardless of the storage rate.

*** **Input level beyond this range may damage the instrument.**

Specifications are subject to change without notice.

OPERATION

4.1 LED Control Operation and Status Function

The ON/SLEEP state of the SLII can be determined by pressing the **PRESS** button for less than 0.5 seconds. If the instrument is ON, the status of the instrument will be shown by the LEDs. If the instrument is in SLEEP mode, all the status LEDs will light until the **PRESS** button is released. Once released, the status indication resumes.

If the instrument is in its sleep state, it can be woken up by pressing the **PRESS** button until all LEDs light. At this point, the button can be released to show the status of the instrument.

Control of the instrument is performed by pressing and holding the **PRESS** button until the control LED corresponding to the desired operation lights. Releasing the button when the desired control LED is illuminated results in the corresponding operation being performed.

When holding the **PRESS** button, each LED will light in sequence. Continuing to hold the **PRESS** button will result in all LEDs being off after the last LED lights. If you continue to hold the button down, the sequence will repeat with the first LED. Releasing the button after the last LED turns off and before the first LED turns on will result in no action being taken by the instrument. This provides a mechanism to cancel (or ignore) the button press.

The instrument will go into a sleep state to conserve power before a scheduled recording starts and will wake up shortly before a recording start time.

The **Control and Status Operation** of each LED is as follows:

GREEN LED		
CONTROL	Starts a Recording	
STATUS	Single-blink	Logger is in Standby Mode (and not recording)
	Double-blink	Logger is in Record Mode

ORANGE LED		
CONTROL	Stops a Recording	
STATUS	OFF	Logger is not in an Overload condition
	Single-blink	One or more inputs are in an Overload condition

YELLOW LED		
CONTROL	Clears the Alarm State (see § 4.6)	
STATUS	OFF	No alarm has been seen on any input
	Single-blink	At least one channel has seen an alarm at least once
	Double-blink	At least one channel is currently in an alarm condition
	Fast-blink	Armed to clear alarm indication

RED LED		
CONTROL	Erases the Memory (See § 4.7)	
STATUS	OFF	No data in memory
	Single-blink	Memory is partially filled
	Double-blink	Memory is full
	Fast-blink	Armed to erase memory
	Slow-blink	Erase memory in process

BLUE LED		
CONTROL	N/A	
STATUS	OFF	Battery voltage is above 2.2 volts
	Single-blink	Battery voltage is below 2.2 volts
	Double-blink	Indicates a recording is scheduled



Overload occurs when any input is 10% above its input range. When the battery voltage goes below 1.7 volt the instrument will shut down (terminating and saving the recording, if it is recording).

- **SLEEP mode:** The instrument enters the low power state if the button is not pressed for one minute. It will remain in this state until either the button is pressed or the internal clock reaches the start time for a scheduled recording.
- **RECORD mode:** The instrument enters the low power state between sample sets. The slower the storage rate, the greater the portion of time the instrument is in the low power state. Thus, the slower the storage rate, the longer the instrument can record.

4.2 Connecting the Simple Logger® II to a Computer



INSTALL DATAVIEW® BEFORE CONNECTING TO THE COMPUTER (SEE § 5).

Connect the Simple Logger® II to a USB communication port on your computer. Refer to the computer manual to locate the USB port on your computer.

The logger can be connected to the computer during a recording session, however, an additional drain on the batteries will occur to support the active USB connection.



If all LEDs light instantaneously, the instrument was in **SLEEP** mode. Releasing the **PRESS** button will show the status (every 5 seconds).

- Connect the instrument to a USB port on your computer and establish communication with the instrument using DataView®. The logger will remain ON while a communication link with the Data Logger Control Panel is active (provided sufficient battery power is available during the communication session).

The instrument contains protection circuitry to prevent it from being turned on when the battery voltage is below 1.7V.

There are two thresholds for the battery voltage:

- **The first is used to indicate low battery.** The low battery indicator (Blue LED single blink) will blink when the battery voltage drops below 2.2V.
- **The second is used to determine when to terminate recording and turn the unit off.** The shutdown threshold is when the battery voltage drops below 1.7V.



Communication from the instrument to DataView® is disabled below 2.2V.

4.3 Recording Data



The Simple Logger® II must first be configured before a recording can be performed (see the DataView® Data Logger Control Panel Help).

Once a configuration is written to the instrument, the logger will no longer need to be connected to DataView® to start the scheduled recording.

When data is stored in the memory, the user may download the information onto a hard-disk.



A scheduled recording will still start even if the logger is in sleep mode.

4.3.1 Starting a Recording Session



A new recording cannot be started if the memory is full.

1. Connect the instrument to the measurement source.
2. Make sure the logger is in **STANDBY** mode.
3. Press and hold the **PRESS** button. When the **START (GREEN)** LED lights up, release the button.
4. The GREEN LED double-blinks every 5 seconds when the logger is recording.



It may take a few seconds before the instrument starts recording. The recording status LED will single blink during this period.

4.3.2 Stopping a Recording Session

1. Press and hold the **PRESS** button. When the **STOP** (ORANGE) LED lights up, release the button.
2. The GREEN LED will change from a double-blink to a single-blink, indicating **STANDBY** mode.

The data will be retained, even if the instrument is in sleep mode. The recorded data is stored in Flash memory (maintained even in the absence of batteries). The recorded data may be downloaded to a computer.

4.4 Downloading Recorded Data

Recorded measurements stored in the instrument are transferred to a computer via the download command in the Data Logger Control Panel.

4.5 Clearing Alarm Indication

Clearing alarms can be performed in the **STANDBY** or **RECORD** mode.

1. Press and hold the **PRESS** button. When the **ALARM** (YELLOW) LED lights up, release the button. The YELLOW LED will blink at a fast rate for a period of five seconds.
2. Press the **PRESS** button for another 0.5 second to complete the operation.



This does not clear any stored alarms, only indications. Stored alarms can only be cleared when memory is erased (see § 4.6).

4.6 Erasing Data from Memory

Erasing data from the instrument's memory can only be performed while in the STANDBY mode.

There are two ways to erase the memory:

Erasing the Memory using the PRESS Button:

1. Press and hold the **PRESS** button. When the **ERASE (RED)** LED lights up, release the button.

This will arm the instrument for an erase operation (when not in record mode). While armed to erase memory, the RED LED will blink at a fast rate for a period of five seconds.

2. Press the **PRESS** button for another 0.5 seconds to start the erase operation. During the erase operation the LED will blink once every second. Erasure takes about 20 seconds to complete.



If the button is not pressed within five seconds of arming, the erase operation will automatically disarm and memory will be maintained. For this reason, if you do not intend to erase memory, simply wait until the RED LED stops blinking at the fast rate.

Erasing the Memory using the Data Logger Control Panel:

1. Connect the instrument to the computer, then open the **Data Logger Control Panel**.
2. Select **Erase Memory** from the **Instrument Menu**.
3. A dialog box will appear asking to confirm the erasure of the instrument's memory. Select **Yes** to confirm or **No** to cancel the operation.



Erasing the memory will also clear any stored alarms.

4.7 Data Storage

The logger captures Trend measurements.

The following are definitions of terms used in this section:

Input Channel: Source for the measurement channel of the instrument.

Measurement Channel: Measurement of input. This can be a simple direct measurement, the result of complex mathematical operations on a single or multiple input, or other channels.

Sample Rate: The rate at which the instrument measures inputs.

Storage Rate: The rate at which channel measurements are stored.

4.7.1 Trend Measurements

The logger stores the measurement of each of the inputs. In addition, the user can define the storage rate, recording period and measurement format using the **Configure Instrument** dialog box in the Data Logger Control Panel software. Trend measurements are stored at this fixed storage rate.



EXAMPLE: AC loggers store TRMS calculation of a single line cycle. DC loggers store the conversion result of each input.

4.8 Logger Operation

When the instrument is in STANDBY mode, the following occurs (provided there is sufficient battery voltage and no data is stored in the instrument's memory):

- The GREEN LED single-blinks every 5 seconds. (STANDBY mode is active and the logger is not recording).
- The RED LED is OFF, indicating there is no data in memory.
- The **PRESS** button is used to Start/Stop a Recording Session.
- If the **PRESS** button is not pressed for a period of one minute, the instrument will enter SLEEP mode and wait for either another button press or the recording start time to arrive (if a recording is scheduled). While in SLEEP mode, the LEDs will not blink.
- A button press of 0.5 seconds will return the unit back to the normal STANDBY mode.

4.8.1 Recording with Memory Cleared

When a recording starts, the logger will continue to record until one of the following occurs:

- The Session is complete.
- The Memory is full and the recording mode is Start/Stop or Alarm.
- The **PRESS** button is pushed until the STOP (ORANGE) LED lights up and is released before the next LED lights.
- The Stop Recording command from the Data Logger Control Panel is sent to the unit.
- The battery voltage falls below 1.7V.

4.8.2 Recording with a Partial or Full Memory

If the RED LED is double-blinking every 5 seconds, the memory is full and must be erased before any further recording can be performed.

If the RED LED is single-blinking every 5 seconds prior to starting a New Recording Session, the memory is partially full.

To save, clear or check memory availability, use the Data Logger Control Panel software.

There may be instances where the GREEN LED is also double-blinking every five seconds indicating that the logger is still recording. The user can choose to stop the Recording Session and download the session and/or erase the memory.



The logger memory cannot be erased while in the Record mode. The recording must be stopped first.

4.8.3 Memory Filled During Recording Session (Start/Stop Mode)

If the logger is recording using the Start/Stop mode and memory is filled before the Recording Session has finished, the session will end.

The following happens after the **PRESS** button is pushed for 0.5 second:

- The GREEN LED single-blinks (standby mode).
- The RED LED double-blinks (full memory).

At this time:

- The memory can be downloaded and erased.
- A new recording can be started or scheduled once memory is erased.



If in either the XRM or FIFO mode, the recording will continue even after memory becomes full. Memory will be freed to make room for new samples. The method of freeing memory will depend on the recording mode.

4.8.4 Battery Power Insufficient for a Full Recording Duration

If the battery voltage drops below 1.7V, the following will occur:

- The Recording Session will terminate.
- The Data will be saved.
- The GREEN and RED LED will turn OFF.

The logger continues to record until the battery voltage drops below 1.7V. Pressing the **PRESS** button will not show the status of the instrument. The battery voltage may rise slightly after the unit turns itself off. In this event, the unit may turn on momentarily as a result of a button press.

The batteries must be replaced before the recorded session(s) can be downloaded from the instrument.



Replacing the batteries while the unit is in SLEEP mode will not result in the loss of data memory. The internal backup capacitor will maintain the clock and memory while the main batteries are being replaced. If the battery level falls below the usable level or if the batteries have been removed for an extended period of time, the clock time will be lost. However, the recorded memory will be maintained.

4.8.5 Recording Session has Ended

The logger will be in STANDBY mode if one of the following occurs:

- The session terminates due to recording end time being reached.
- The recording in START/STOP mode fills the memory.
- The user terminates the session by pressing the **PRESS** button until the STOP (ORANGE) LED lights up and releasing the button before the next LED lights, or issues a Stop Recording command from the Data Logger Control Panel.

The logger is now ready for a New Session or Download. Pressing the **PRESS** button until the START (GREEN) LED lights up and releasing the button before the next LED lights, will start a New Session depending on the available memory.

4.9 Event Logger Operation (Model L404)

The Model L404 monitors up to four channels for the occurrence of events and stores information about each event. The rate at which each input is tested for the event status is defined by the sample period.

Events that are shorter in duration than the period between sampling can potentially be missed. For this reason the sample period should be chosen to be at least twice the fastest event rate (e.g. An event being monitored is expected to occur no faster than once per minute. The sample period should then be set to at least every 30 seconds).

An event starts when the input goes low and ends when the input goes high. For contact closure this would be when the contact is closed and then opened. The logger records the time the event started and the duration of the event. The accuracy of the start time and duration is limited to the rate at which the inputs are tested (as defined by the sample period).

An option to invert the displayed graph is available in the scales tab of the instrument configuration window. This allows for setting the display to show a high as a low for all inputs. This is the default state and will be shown as normally low until an event occurs.

As mentioned, events start and end when the input goes low and when it goes high (regardless of the graph invert option). For voltage measurements this is when the voltage drops below 0.7V and goes above 0.8V. For contact (relay) closures this is when the contact closes and when it opens. Overload will be displayed when the input rises above 5.5V.

The logger will store one event, which means that if there is no change at the input of the instrument, it will not store any data until the next event cycle occurs. This happens when the instrument sees the changes at an input, as previously described.

If the expected event rate is 1s, then it would be necessary to set the sample rate faster than once per second in order to capture the events. As mentioned previously, the timing accuracy of the captured event is dependent on the sample rate. The faster the sample rate, the higher the timing accuracy.

Minimum duration of an event will need to be the duration of the sample rate such that if the sample rate is 125mS, then the pulse will need to be at least 125mS to be certain that the logger will capture the event.

4.9.1 Sample Event Capture

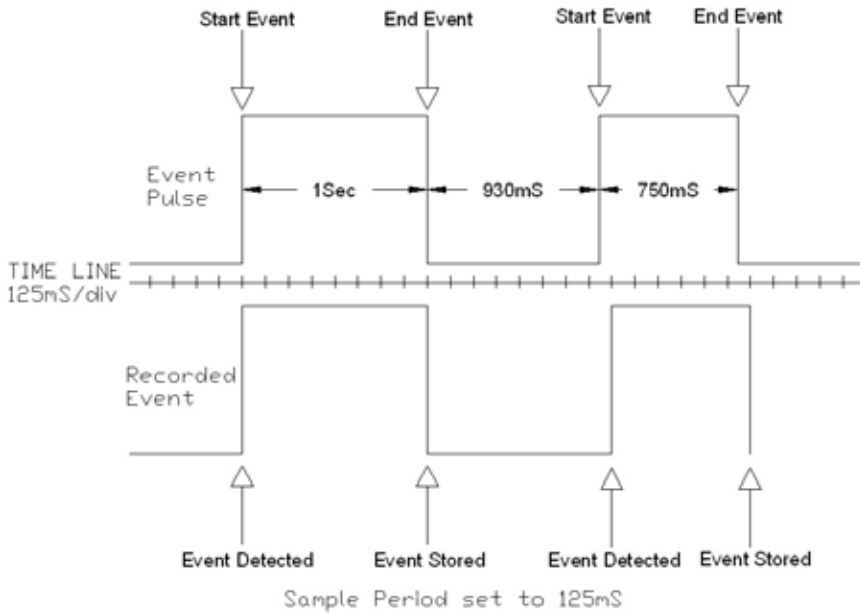

Figure 4-1

The above example assumes that the “Invert display polarity (event displayed as a high)” is selected from the scales tab of the configuration (default setting).

4.9.2 Application Examples

Rain Gauge:

Each time a tipping bucket fills and tips, a contact opens indicating that 0.1 inch of rain has filled the bucket. Attaching the L404 to this contact allows recording of both the number of times the bucket has tipped, as well as the totalization of rainfall during the recording.

In the configuration menu, the user has the ability to program both the weight and value of an event pulse. In this case, the weight would be 0.1 and the units would be in inches.

In Figure 4-2, eight tips occurred for a total of 0.8 inches of rainfall.

Sequencing:

In a processing plant it has been determined that timing on several positions is out of specification. The service staff needs to know the sequence of valve opening and closing, and the duration of each, to correct the problem. The L404 can be connected to four outputs in the process and keep track of the time and duration of each opening and closing, thus providing the technician with the data they need to solve the sequence issue.

In the example below we can see that the valve 1 opened and closed several times during a one minute period, but valves 2, 3 and 4 did not respond.

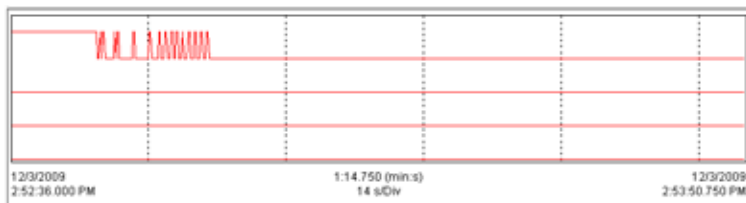

Figure 4-2

4.10 Reset Switch Operation



CAUTION: Risk of electric shock. Disconnect the unit from any input source before opening the rear cover. Electrical shock may occur with damage to the user and/or the instrument.

Resetting the instrument takes about 10 seconds, at which time the instrument will be non responsive.

For Standard Units:

The **RESET** button (see § 2.2.1 for reference to the location), resets the CPU and is located under the top cover. To access this button, remove the battery compartment cover, remove the four screws holding the two halves of the case together. The reset button is located on the exposed PCB near the input(s).

For Model CL601:

To access the **RESET** button (see § 2.2.2 for reference to the location), remove the battery compartment cover. The button is located to the left of the batteries.



It is recommended to only press the **RESET** button when the logger stops responding to a normal press button control when not connected to Data-View®. It is not recommended to reset the instrument when the logger is recording, downloading or being configured.

If the logger is not responding to a button press, make sure the unit has sufficient battery power. If the battery voltage is below 1.7V, the unit will not respond to a button press. In this condition, pressing the **RESET** button will not restart the unit.

It is recommended to download any desired session and erase the memory before starting a new recording.



The resumption of the logger operation in the above situations assumes that the **RESET** button cleared the fault(s). The logger will not resume normal operation if the fault condition still exists. The instrument will try to recover normally. However, under certain conditions, the clock and memory full state may reset, meaning that the memory is marked as full and the clock date/time is lost.

4.11 Flash Upgrade Switches

The Flash Upgrade Switches (see § 2.2.1 and 2.2.2 for reference to the location) are used to recover from a failed flash upgrade.

Both switches should be turned to the “ON” position in order to flash upgrade the instrument using the “Fail Safe” method of upgrade from within the “SLIIFlashUp1xx” utility program.

Both switches **MUST** be set to the “OFF” position once the upgrade has completed.



Failure to set both Flash switches OFF after the upgrade will prevent the instrument from operating properly and deplete the batteries.

SOFTWARE INSTALLATION

5.1 Installing DataView®



DO NOT CONNECT THE INSTRUMENT TO THE PC BEFORE INSTALLING THE SOFTWARE AND DRIVERS.

USB Flash Drive Install

1. Insert the DataView thumb drive into an available USB port on your computer. If Autorun is enabled, an AutoPlay window appears on your screen. Click “Open folder to view files” to display the DataView folder. **NOTE:** If Autorun is not enabled or allowed, use Windows Explorer to locate and open the USB drive labeled “DataView.”
2. When the DataView folder is open, find the file Setup.exe and double-click it to run the installation program. The DataView setup screen appears.
3. In the upper left corner of the screen, choose the language version of DataView to install. In the lower left corner are the available installation options.
 - In addition to the DataView software, you can select **Adobe Reader**. This links to the Adobe web site here you can download the latest version of Reader. This program is required to view DataView PDF documents.
 - The option **DataView Update** opens the AEMC website where you can check for the latest DataView software version releases.
 - Similarly, **Firmware Upgrades** links to the website where you can check for new firmware updates for the logger.
 - Finally, **User Manuals** installs the printable documentation that accompanies DataView. (DataView also comes with a Help system that is installed with the program files.)

Make your selections and click Install.

4. After a few moments the DataView InstallShield Wizard welcome screen appears. The InstallShield Wizard program leads you through the DataView installation process. To proceed, click Next.
5. Read the license agreement and indicate your acceptance by clicking "I accept the terms of the license agreement." Then click Next.
6. At the Customer Information screen, enter your username and company name. Also choose whether this installation is for all users of the computer, or just for your username. Click Next to proceed.
7. The next screen lets you select the DataView setup. If you choose Custom, you are prompted to select individual DataView components to install. To install the full DataView product, select Complete and then click Next.
8. You are now prompted to select the Control Panel(s) you want to install. Each AEMC product family has its own specially designed Control Panel. By default, all available Control Panels are selected. Control Panels take up disk space on the computer, so unless you have other types of AEMC instruments, we recommend that you select Data Logger and deselect the rest. You should also check the option PDF-XChange, which is a requirement if you plan to create .pdf versions of DataView reports.

After you finish selecting and deselecting Control Panels, click Next.

9. The InstallShield Wizard now informs you that the program is ready to install DataView. If you want to review any of your previous selections, click the Back button to return to earlier screens. Otherwise, click Install to begin installation.
10. The InstallShield Wizard now installs DataView. During this process, a status bar displays the progress of the installation. During installation, you may see a warning message about installing DataView with your AEMC instrument connected to the computer. If the instrument or USB cable is connected, disconnect it now. Then click OK to proceed.
11. After a few moments, a screen appears informing you that installation is complete. Click Finish to leave the InstallShield Wizard. You are now asked whether or not you would like to view instructions about how to connect the AEMC instrument or cable to the USB port on the computer. Click Yes to view these instructions, or No to proceed.

12. Close the DataView Setup screen. The DataView icon  now appears on your computer desktop, along with the Data Logger

Control Panel icon  and the icon(s) for any other Control Panel(s) you have installed.

5.2 Data Logger Control Panel

After you install DataView, the DataView icon appears on your desktop. This opens the core DataView program. The installation process also places the Data Logger Control Panel icon on your desktop. Clicking this icon opens the Data Logger Control Panel.

In general, core DataView features are for creating, viewing, editing, and storing DataView reports; while the Control Panel is for connecting to, configuring, viewing real-time measurements, and downloading data from the instrument. You can access all DataView features through either the DataView icon or the Control Panel icon. For users who interact with a single type of AEMC instrument, we recommend primarily using the Control Panel. However, there are situations where using the core DataView icon may be more convenient for some users, such as when viewing multiple archived reports from different AEMC product families.

NOTE: *For further information about DataView and its capabilities, or for information about using the Data Logger Control Panel, consult the Help system that comes with the product. Access this Help by clicking the option Help in the Control Panel's menu bar at the top of the screen.*

MAINTENANCE

Use only factory specified replacement parts. AEMC® will not be held responsible for any accident, incident, or malfunction following a repair done other than by its service center or by an approved repair center.

6.1 Replacing the Batteries



CAUTION: Risk of electric shock. Disconnect all input(s) from the unit or remove the clamp from any conductor before opening the rear cover to change the batteries. Turn the unit off before changing the batteries or loss of recorded data may occur.

- Remove the screw from the battery cover.
- Push down and slide off cover to remove.
- Replace the two 1.5V AA (LR6) alkaline batteries (the backup capacitor provides backup power for approximately 10 seconds while the main batteries are being changed).
- Replace the cover and the screw.
- Press the **PRESS** button for 2 seconds to turn the instrument ON.

NOTE: When changing the batteries, always replace both batteries.



If the instrument is stored without the batteries installed, the internal clock will need to be reset using the Data Logger Control Panel software once the batteries are installed. Only store the unit with the batteries installed for short periods of time. For prolonged storage of the unit, it is recommended to remove the batteries.

6.2 Replacing the Fuse (Model L111)



CAUTION: Risk of electric shock. Disconnect all input(s) from the unit or remove the clamp from any conductor before replacing the fuse.

- With a flat-head screwdriver, twist the spring-loaded fuse holder one quarter turn counter-clockwise.
- The fuse holder will automatically eject.
- Replace with a new 2A FA 250V 5x20mm fuse, then replace holder.

6.3 Cleaning



CAUTION: Risk of electric shock. Remove the clamp from any conductor or disconnect all input(s) from the unit.

The body of the logger should be cleaned with a damp and soapy cloth. Do not submerge the logger in water. Do not use solvent.

For the Model CL601, it is important to keep the jaw mating surfaces clean at all times. Gently clean the clamp-on jaw mating surfaces with a soft cloth and lightly oil them to prevent rust. Do not use water, solvents or leave any residue.

TROUBLESHOOTING

Symptom: After being in a damp, cold environment, the logger does not function.

Cause, Correction: Condensation may have formed inside the logger, shorting out the circuitry and discharging the battery. Allow the circuit board to dry thoroughly in a warm location.

Symptom: Simple Logger® II does not start recording.

Cause, Correction: Make sure battery power is present. Make sure the PRESS button is pushed long enough to light the GREEN LED and released before the next LED lights. Make sure the RED LED is not double- blinking. If it is, memory is full and you need to erase the data (see § 4.6). Make sure the Simple Logger® II is properly configured so that you have Storage Rate, Recording Period and at least one Measurement Channel specified.

Symptom: Simple Logger® II does not respond to a button press even with fresh batteries installed.

Cause, Correction: Make sure that the instrument is not OFF. Press the button for a short duration (less than 0.5 second). If all the LEDs do not light, then the instrument is OFF. Turn the instrument ON by pressing the PRESS button for two seconds. The LEDs will light solid once the instrument has turned on and you may release the button at that time.

GLOSSARY

Some general terminology associated with the data collection process is listed here for convenience.

Bps: Bits Per Second, a unit of signal transfer speed equal to the number of elements per second. The Simple Logger® II transfers data at the rate of 115200 bps.

Button: An actual key on the logger or computer keyboard or a soft key in the program on the computer screen.

Data logger: A device used to sample and store electrical signals that may be representative of physical phenomena such as temperature, pressure and flow, for long periods of time in an unattended environment.

Download: The process of transferring data from the logger to the computer.

Hz: Hertz, a unit of measure of frequency equivalent to cycles per second.

I/O: Input/output, a device or port capable of sending or receiving digital information.

Port: A name given to any connector allowing input or output of information.

Processor: A computing device used to calculate and run a set of instructions.

Recording session: A recording session is defined as the time and data contained within the starting and ending of a recording.

Resolution: The last significant digit of the measurement.

Zoom: The ability to select a section of the graph and magnify it for better readability.

USB: Universal Serial Bus, a communications port used to access the Data Logger via a computer program (Dataview®).

Repair and Calibration

To ensure that your instrument meets factory specifications, we recommend that it be sent back to our factory Service Center at one-year intervals for recalibration, or as required by other standards or internal procedures.

For instrument repair and calibration:

You must contact our Service Center for a Customer Service Authorization Number (CSA#). This will ensure that when your instrument arrives, it will be tracked and processed promptly. Please write the CSA# on the outside of the shipping container. If the instrument is returned for calibration, we need to know if you want a standard calibration, or a calibration traceable to N.I.S.T. (Includes calibration certificate plus recorded calibration data).

Ship To: Chauvin Arnoux®, Inc. d.b.a. AEMC® Instruments
15 Faraday Drive
Dover, NH 03820 USA
Phone: (800) 945-2362 (Ext. 360)
(603) 749-6434 (Ext. 360)
Fax: (603) 742-2346 or (603) 749-6309
E-mail: repair@aemc.com

(Or contact your authorized distributor)

Cost for repair, standard calibration, and calibration traceable to N.I.S.T. are available.

NOTE: You must obtain a CSA# before returning any instrument.

Technical and Sales Assistance

If you are experiencing any technical problems, or require any assistance with the proper operation or application of your instrument, please call, mail, fax or e-mail our technical support team:

Chauvin Arnoux®, Inc. d.b.a. AEMC® Instruments
200 Foxborough Boulevard
Foxborough, MA 02035 USA
Phone: (800) 343-1391
(508) 698-2115
Fax: (508) 698-2118
E-mail: techsupport@aemc.com
www.aemc.com

NOTE: Do not ship instruments to our Foxborough, MA address.

Limited Warranty

The Simple Logger® II is warranted to the owner for a period of one year from the date of original purchase against defects in manufacture. This limited warranty is given by AEMC® Instruments, not by the distributor from whom it was purchased. This warranty is void if the unit has been tampered with, abused or if the defect is related to service not performed by AEMC® Instruments.

Full warranty coverage and product registration is available on our website at www.aemc.com/warranty.html.

Please print the online Warranty Coverage Information for your records.

What AEMC® Instruments will do:

If a malfunction occurs within the one-year period, you may return the instrument to us for repair, provided we have your warranty registration information on file or a proof of purchase. AEMC® Instruments will, at its option, repair or replace the faulty material.

**REGISTER ONLINE AT:
www.aemc.com**

Warranty Repairs

What you must do to return an Instrument for Warranty Repair:

First, request a Customer Service Authorization Number (CSA#) by phone or by fax from our Service Department (see address below), then return the instrument along with the signed CSA Form. Please write the CSA# on the outside of the shipping container. Return the instrument, postage or shipment pre-paid to:

Ship To: Chauvin Arnoux®, Inc. d.b.a. AEMC® Instruments
15 Faraday Drive • Dover, NH 03820 USA
Phone: (800) 945-2362 (Ext. 360)
(603) 749-6434 (Ext. 360)
Fax: (603) 742-2346 or (603) 749-6309
E-mail: repair@aemc.com

Caution: To protect yourself against in-transit loss, we recommend you insure your returned material.

NOTE: You must obtain a CSA# before returning any instrument.



11/16

99-MAN 100309 v25