

■ INFRARED K-THERMOMETER
WITH LASER

CA876

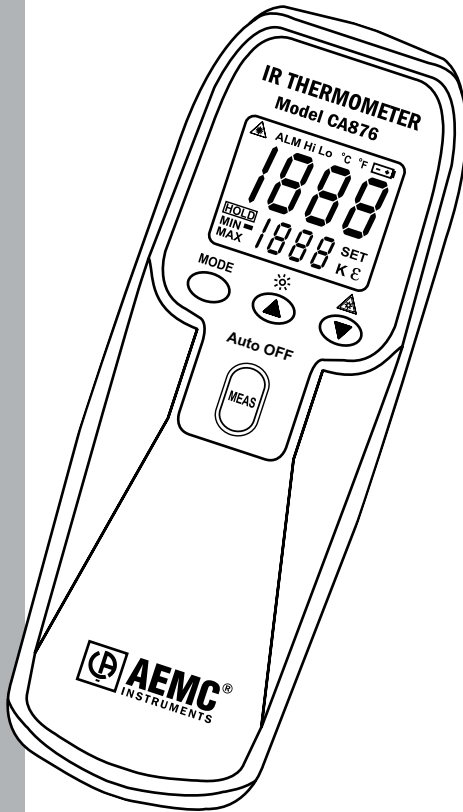

Owner's Record

The serial number for the Model CA876 is located inside the battery compartment of the instrument. Please record this number and purchase date for your records.

INFRARED K-THERMOMETER MODEL CA876



CATALOG #: 2121.34

SERIAL #: _____

PURCHASE DATE: _____

DISTRIBUTOR: _____

Table of Contents

1. INTRODUCTION	2
1.1 International Electrical Symbols.....	3
1.2 Receiving Your Shipment.....	3
1.3 Ordering Information	3
2. PRODUCT FEATURES	4
2.1 Description	4
2.2 Button Functions	5
2.2.1 Center (Yellow) Button - MEAS	5
2.2.2 Mode Button	5
2.2.3  Back-light and ▲ Button.....	6
2.2.4  Laser and ▼ Button.....	6
3. SPECIFICATIONS	7
3.1 Environmental Specifications.....	7
3.1.1 Infrared	7
3.1.2 K-Type	8
3.2 General Specifications	9
3.3 Safety Specifications.....	9
4. OPERATION.....	10
4.1 Infrared Measurement Considerations.....	10
4.2 Recommendations before Operating	11
4.3 Infrared Operation.....	12
4.4 K-Thermocouple Operation.....	12
4.5 Setting the Temperature Scale: °C or °F.....	13
4.6 Continuous Measurement	13
5. MAINTENANCE	14
5.1 Replacing the Battery	14
5.2 Cleaning.....	14
Repair and Calibration.....	15
Technical and Sales Assistance	15
Limited Warranty	16
Warranty Repairs.....	16

INTRODUCTION



- Thermometers are not designed to touch live electrical samples.
- Do not use this instrument with Thermocouple K when voltages at the sample point exceed 24VDC or 24Vrms.
- Do not make temperature measurement in microwave ovens. Leaking microwaves may result in burns and serious injuries.
- To prevent sensor damage, do not point the sensor lens directly at the sun or any other source of strong infrared light.
- Do not look directly into the laser beam, and do not aim the laser beam into eyes.
- Do not place the infrared thermometer directly on or close to objects at temperatures exceeding 158°F (70°C).
- To prevent measurement errors, do not expose the thermometer to strong electrical or electromagnetic fields.
- To prevent sensor damage and erroneous readings, do not put the sensor lens into contact with any body or foreign/loose material when measuring. Keep the sensor perfectly clean.
- Do not touch the sensor when taking measurements as it may affect the readings.
- When the meter is exposed to sudden temperature changes (hot or cold), allow 20 minutes of stabilization before taking a reading.
- Be certain there is no condensation on the lens prior to taking measurements. Allow 10 minutes for condensation to dissipate as needed.
- The Model CA876 is not waterproof or dust-proof. Take necessary precautions to protect it in wet or dusty environments.
- Repeated sharp flexing can cause the thermocouple leads to break. To prolong sensor life, avoid sharp bends in the thermocouple, especially near the connector.

1.1 International Electrical Symbols



This symbol on an instrument indicates a WARNING and that the operator must refer to the user manual for instructions before operating the instrument. In a manual, the symbol preceding instructions indicates that if the instructions are not followed, bodily injury, installation/sample and product damage may result.



Laser Radiation - **DO NOT** look into the laser beam.
Laser Output < 0.5mW, 670nm wavelength.

1.2 Receiving Your Shipment

Upon receiving your shipment, make sure that the contents are consistent with the packing list. Notify your distributor of any missing items. If the equipment appears to be damaged, file a claim immediately with the carrier and notify your distributor at once, giving a detailed description of any damage. Save the damaged packing container to substantiate your claim.

1.3 Ordering Information

Infrared Thermometer Model CA876.....Cat. #2121.34

Includes K-thermocouple, 9V Alkaline battery, rugged, shockproof, protective safety holster and user manual.

PRODUCT FEATURES

2.1 Description

The AEMC® Model CA876 is a portable, easy-to-use, compact-sized digital infrared and K-thermocouple input thermometer, designed for simple one-hand operation. It uses an infrared sensor with a user adjustable emissivity setting.

The thermometer is simply aimed at the target to be measured without any physical contact when in the IR mode (non-contact temperature measurement). An aiming laser enables the user to pinpoint the target. The K-type thermocouple input may also be used. The thermometer includes a programmable Alarm, which triggers on Hi or Lo, and a MIN or MAX Hold function. The thermometer is supplied with a protective holster, built-in sensor, and a K-type bead thermocouple. It also features a back-light LCD display, an automatic data HOLD function, and Auto-OFF.

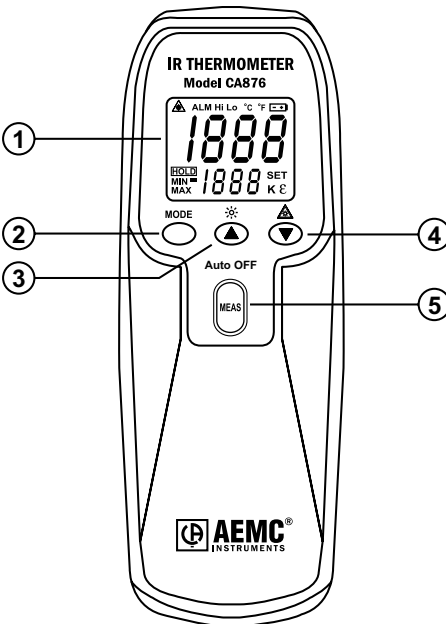

1. 3½ digit display
2. Mode selector
3. Back-light/Increase button
4. Laser/Decrease button
5. Power/Measure button

2.2 Button Functions

2.2.1 Center (Yellow) Button - MEAS

Press this button to turn the thermometer ON and perform a measurement. When the button is released, the meter will automatically HOLD (freeze) the last reading on the display for approximately 15 to 20 seconds before automatically shutting OFF.

2.2.2 Mode Button

Pressing this button makes the thermometer enter and advance through several functions including some programmable functions. The MODE button is used to select a specific function (e.g. MIN, MAX) or to adjust an Alarm or the emissivity.

To enter the mode program, press **MODE** once. SET is displayed in lower right hand corner.

When pressed consecutively, it will scroll through the following settings:

$\epsilon \rightarrow \epsilon \text{ (Set)} \rightarrow \text{ALM Hi (Set)} \rightarrow \text{ALM Lo (Set)} \rightarrow \text{MAX} \rightarrow \text{MIN} \rightarrow \text{K} \rightarrow \epsilon$

SET is displayed in the lower right hand corner of the display when a selected function is programmable (ϵ , ALM Hi, ALM Lo).

ϵ : Emissivity may be adjusted with the ▲ and ▼ buttons to match a particular target. We recommend leaving it at 0.95 for general use.

ALM Hi: The Hi alarm set point is adjusted using the ▲ and ▼ buttons. When this set point is reached the beeper will sound and ALM HI will be displayed.

ALM Lo: The Lo alarm set point is adjusted using the ▲ and ▼ buttons. When this set point is reached the beeper will sound and ALM Lo will be displayed.

MAX: The Max value measured will be displayed during measurement. While in the MAX mode and when measuring, the MODE button will toggle the measurement between MAX – MIN – Present reading – MAX.

MIN: The Min value measured will be displayed during measurement. While in the MIN mode and when measuring, the MODE button will toggle the measurement between MIN – Present reading – MAX – MIN.

K: The lower display will indicate the reading from the K-type thermocouple.



NOTE: If the thermometer is OFF, pressing the “MEAS” button for more than 4 seconds will set the thermometer in the MIN/MAX record mode when powered up.

2.2.3 Back-light and Button

Press the  button to turn the Back-light ON. Press again to turn OFF.

In the settings ε , ALM Hi and ALM Lo, the  button increases the numerical value displayed in the lower smaller display area. If held down, the value change will increase in speed.

2.2.4 Laser and Button

Pressing the  button turns the laser ON or OFF. The  symbol is displayed in the upper left hand corner when the laser is ON.

Remove the laser cover before use.

The laser is activated when the “MEAS” button is pressed during a measurement.

In the settings ε , ALM Hi and ALM Lo, the  button decreases the numerical value displayed in the lower smaller display area. If held down, the value change will decrease in speed.

NOTE: There is no ON/OFF button. The meter turns ON when the center “MEAS” button is pressed, and will automatically shut OFF after approximately 15 to 20 seconds.

SPECIFICATIONS

3.1 Environmental Specifications

3.1.1 INFRARED

Temperature Scale:

Celsius (°C) or Fahrenheit (°F) user-selectable

Temperature Range:

-4°F to 1022°F (-20°C to 550°C)

Display Resolution:

1°F / 1°C

Accuracy:

< 212°F (100°C) ± 10°F (5°C)

> 212°F (100°C) ± 2% of Reading or ± 6°F (3°C), whichever is greater @ 64.4 to 82.4°F (18 to 28°C) ambient operating temperature.

Temperature Coefficient:

Changes in accuracy operating temperature above 82.4°F/28°C or below 64.4°F/18°C: ±0.2% of Reading or ± 0.36°F/0.2°C, whichever is greater.

Response Time:

1 second

Laser:

Red, <0.5mW (670nm) Class II, 2 - 50 ft range

Spectral Response:

6 to 14µm nominal

Emissivity:

Pre-set @ 0.95, user-selectable from 0.10 to 1.00

Detection Element: Thermopile

Optical Lens: Fresnel Lens

Field of View (FOV) ratio:

10:1 (Distance : Diameter)

The FOV is the ratio of the distance to the target to the target diameter. When the target diameter is small, it is important to bring the thermometer closer to the target to ensure that only the target is measured, excluding the surroundings. Remember that the measurement size is one-tenth the distance to the target. For example, if the thermometer is at 10", then the size measured is 1".

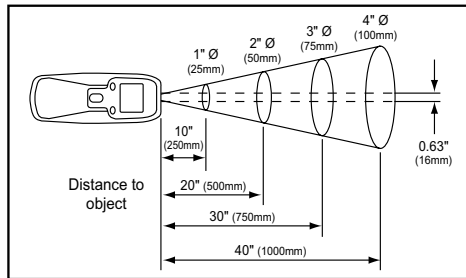

3.1.2 K TYPE

Temperature Scale: Celsius (°C) or Fahrenheit (°F) - User-selectable

Measurement Range: -40° to 2000°F or -40° to 1350°C

Resolution: 0.1°F/°C or 1°F/°C

Accuracy: -328°F to 1999°F: ± 0.1% of Reading ± 2°F plus T.C.
-199°C to 1370°C: ± 0.1% of Reading ± 1°C plus T.C.

(Accuracy is specified for operating temperatures over the range of 64° to 82°F (18° to 28°C), for 1 year, excluding the sensor)

Temperature Coefficient:

0.1 times the applicable accuracy specification per °C from 0° to 18°C and 28° to 50°C

Input Protection:

24V_{DC} or 24V_{RMS} maximum input voltage on any combination of inputs

Sample Rate: 2.5 times per second

Input Connector:

Standard miniature thermocouple connectors (flat blades spaced 7.9mm, center-to-center)

Temperature Response:

Temperature indication follows Reference Temperature/Voltage Tables N.I.S.T. Monograph 175 Revised to ITS-90 for K-type thermocouples

3.2 General Specifications

Display: 2000-count, 3½ digit liquid crystal display (LCD) with maximum reading of 1999

Low Battery Indication:  is displayed when battery voltage drops below required level

Sample Rate: 2.5 times per second, nominal

Operating Temperature: 32° to 122°F (0° to 50°C) at < 80% RH

Storage Temperature:

-4° to 140°F (-20° to 60°C), 0 to 80% RH with battery removed

Auto Power Off: 15 seconds approx

Altitude: 2000m max

Input Protection: 24V_{DC} or 24rms maximum input voltage on any combination of inputs

Battery: Standard 9V battery (NEDA 1604, 6LR61 or equivalent)

Battery Life: 100 hours (continuity) typical with carbon zinc battery (backlight not illuminated)

Dimensions: 6.81 x 2.38 x 1.5" (173 x 60.5 x 38mm)

Weight: Approx 9 oz (255g) including battery

3.3 Safety Specifications



EN 61010-1 (1995-A2), Protection Class III

Overvoltage Category (CAT III, 24V), Pollution Degree 2

Indoor Use

**All specifications are subject to change without notice*

OPERATION

4.1 Infrared Measurement Considerations

MEASUREMENT THEORY

Every object emits infrared (IR) energy proportional to its temperature. By measuring the amount of this radiant energy, it is possible to determine the temperature of the emitting object. Infrared radiation is invisible light (electromagnetic radiation), which easily travels through air and is easily absorbed by solid matter. An IR thermometer, which operates by detecting infrared radiation, can accurately measure an object surface temperature without touching it and independently of the air temperature or the measurement distance.

Infrared radiation, which is emitted from the object, is focused into an infrared radiation sensor through an optical system. This system includes an optical lens, which is transparent to infrared radiation, and a 5.3 μm cut off filter. The output signal from the infrared radiation sensor is input to an electronic circuit, along with the output signal from a standard temperature sensor, to calculate the temperature and display it on the meter display.

EMISSIVITY

All objects emit invisible infrared energy. The amount of IR energy emitted is proportional to the object's temperature and its natural ability to emit IR energy. This ability, called emissivity, is based upon the object material type and its surface finish. Emissivity values range from 0.10 for a very reflective object to 1.00 for a black body. Factory set emissivity value of 0.95 will cover 90-95% of typical applications.

If frost or other material/substance covers the measured surface, clean it to expose the surface. If the surface to be measured is highly reflective, apply dull masking tape or matte black paint over the surface. If the thermometer seems to be giving incorrect readings, check the front sensor. There may be condensation or debris obstructing the sensor. Only clean per instructions.



Material	Emmissivity
Asphalt	0.90 to 0.98
Concrete	0.94
Cement	0.96
Sand	0.90
Earth	0.92 to 0.96
Water	0.92 to 0.96
Ice	0.96 to 0.98
Snow	0.83
Glass	0.90 to 0.95
Ceramic	0.90 to 0.94
Marble	0.94
Plaster	0.80 to 0.90
Mortar	0.89 to 0.91
Brick (red)	0.93 to 0.96

Material	Emmissivity
Cloth (black)	0.98
Human skin	0.98
Lather (Soap)	0.75 to 0.80
Charcoal (powder)	0.96
Lacquer	0.80 to 0.95
Lacquer (matte)	0.97
Rubber (black)	0.94
Plastic	0.85 to 0.95
Timber	0.90
Paper	0.70 to 0.94
Chromium oxide	0.81
Copper oxide	0.78
Iron oxide	0.78 to 0.82
Textiles	0.90

4.2 Recommendations before Operating

- If the measured surface target diameter is less than 2"/50mm Ø, then place the sensor as close as possible to the target surface (<20"/50cm away). See Field of View (FOV) information under Specifications.
- If the target surface is covered with frost or any matter, clean it before taking a measurement.
- If the target surface is highly reflective put some matte tape, or matte paint, over it before measuring.
- If the thermometer is erratic, or seems not to be measuring properly, make sure that the sensor is clean and not covered by condensation.

4.3 Infrared Operation

1. Press and hold the yellow measurement button - MEAS.
The thermometer will display SET briefly on the main display while it auto-checks.
2. Aim the Thermometer towards the target.
3. If using the aiming laser, remove the laser cover, and press the  Button to turn the laser ON and OFF. The laser is activated when MEAS is pressed.
4. Infrared thermometer sensors need a certain time to stabilize to ambient temperature. Remember to let the IR meter reach ambient if brought in from different temperature environment.
5. Press the  button to turn ON the back-light.
6. If the measured temperature is outside the measurement range, \overline{OL} will be displayed.
7. The thermometer will continue measuring as long as the MEAS button is pressed. When the button is released the measurement will be held in the display for 15-20 seconds. HOLD is displayed in the lower left-hand corner of the display.
8. The IR thermometer will shut OFF automatically after 15-20 seconds.

4.4 K-Thermocouple Operation

1. Connect the K-thermocouple to the instrument input.
2. Press MEAS to turn the thermometer ON.
3. Press the MODE button (six times) to enter the thermocouple mode. K will be displayed in lower right hand corner of the display.
4. Put the thermocouple near or on the sample tested.
5. Press MEAS button to measure. Thermocouples need a certain time to respond. Take the reading when the measurement has stabilized. The reading is displayed in the smaller lower display in front of the K symbol. The main larger display is the IR temperature reading.
6. The thermometer will continue measuring as long as the MEAS button is pressed. When the button is released, the measurement will be held in the display for 15-20 seconds.



7. When finished, remove the thermocouple from the sample, and unplug the thermocouple from the meter. The thermometer will shut OFF automatically after 15-20 seconds.

Note: IR measurements are active at the same time as the K t/c measurements.

4.5 Setting the Temperature Scale: °C or °F

The temperature scale is displayed on the upper part of the display.

To select the temperature scale:

- **°C:** When the thermometer is **OFF**, hold down the  button, then press the MEAS button. °C will be displayed.
- **°F:** When the thermometer is **OFF**, hold down the  button, then press the MEAS button. °F will be displayed.

The selected temperature scale will remain until changed by the user.

4.6 Continuous Measurement

The user may want to leave the thermometer ON to measure over an extended time period without having to keep pressing the MEAS button.

To enter the continuous mode:

- Turn the thermometer OFF. Hold down the MODE button, then press the MEAS button. This will set the thermometer in the continuous mode. HOLD will not be displayed in the continuous mode and the laser sighting will not run.
- When finished, press MEAS once. HOLD will be displayed and the thermometer will shut down in 15-20 seconds. Alternatively, press MEAS again to re-enter the continuous mode.

MAINTENANCE

Use only factory specified replacement parts. AEMC® will not be held responsible for any accident, incident, or malfunction following a repair done other than by its service center or by an approved repair center.

5.1 Replacing the Battery

The  symbol appears on the LCD display when replacement is needed. Replace with a standard 9-volt alkaline battery (NEDA 1604, 6LR61).

To replace the battery:

- Turn the meter OFF.
- Remove the rubber holster.
- Remove the screw from the back of the meter and lift off the battery cover.
- Replace the battery, then put the rear cover and holster back on.

5.2 Cleaning

- Use a soft cloth lightly dampened with soapy water.
- Rinse with a damp cloth and then dry with a dry cloth.
- Do not use any abrasives or solvents.
- Do not let any liquid enter the case or sensor area.

Repair and Calibration

To ensure that your instrument meets factory specifications, we recommend that it be scheduled back to our factory Service Center at one-year intervals for recalibration, or as required by other standards or internal procedures.

For instrument repair and calibration:

You must contact our Service Center for a Customer Service Authorization Number (CSA#). This will ensure that when your instrument arrives, it will be tracked and processed promptly. Please write the CSA# on the outside of the shipping container. If the instrument is returned for calibration, we need to know if you want a standard calibration, or a calibration traceable to N.I.S.T. (Includes calibration certificate plus recorded calibration data).

Ship To: Chauvin Arnoux®, Inc. d.b.a. AEMC® Instruments
15 Faraday Drive
Dover, NH 03820 USA
Phone: (800) 945-2362 (Ext. 360)
(603) 749-6434 (Ext. 360)
Fax: (603) 742-2346 or (603) 749-6309
E-mail: repair@aemc.com

(Or contact your authorized distributor)

Costs for repair, standard calibration, and calibration traceable to N.I.S.T. are available.

NOTE: You must obtain a CSA# before returning any instrument.

Technical and Sales Assistance

If you are experiencing any technical problems, or require any assistance with the proper operation or application of your instrument, please call, mail, fax or e-mail our technical support team:

Chauvin Arnoux®, Inc. d.b.a. AEMC® Instruments
200 Foxborough Boulevard
Foxborough, MA 02035 USA
Phone: (800) 343-1391
(508) 698-2115
Fax: (508) 698-2118
E-mail: techsupport@aemc.com
www.aemc.com

NOTE: Do not ship Instruments to our Foxborough, MA address.

Limited Warranty

The Model 876 is warranted to the owner for a period of one year from the date of original purchase against defects in manufacture. This limited warranty is given by AEMC® Instruments, not by the distributor from whom it was purchased. This warranty is void if the unit has been tampered with, abused or if the defect is related to service not performed by AEMC® Instruments.

For full and detailed warranty coverage, please read the Warranty Coverage Information, which is attached to the Warranty Registration Card (if enclosed) or is available at www.aemc.com. Please keep the Warranty Coverage Information with your records.

What AEMC® Instruments will do:

If a malfunction occurs within the one-year period, you may return the instrument to us for repair, provided we have your warranty registration information on file or a proof of purchase. AEMC® Instruments will, at its option, repair or replace the faulty material.

**REGISTER ONLINE AT:
www.aemc.com**

Warranty Repairs

What you must do to return an Instrument for Warranty Repair:

First, request a Customer Service Authorization Number (CSA#) by phone or by fax from our Service Department (see address below), then return the instrument along with the signed CSA Form. Please write the CSA# on the outside of the shipping container. Return the instrument, postage or shipment pre-paid to:

Ship To: Chauvin Arnoux®, Inc. d.b.a. AEMC® Instruments
15 Faraday Drive • Dover, NH 03820 USA
Phone: (800) 945-2362 (Ext. 360)
(603) 749-6434 (Ext. 360)
Fax: (603) 742-2346 or (603) 749-6309
E-mail: repair@aemc.com

Caution: To protect yourself against in-transit loss, we recommend you insure your returned material.

NOTE: You must obtain a CSA# before returning any instrument.

Notes:



03/12

99-MAN 100246 v5

Chauvin Arnoux®, Inc. d.b.a. AEMC® Instruments
15 Faraday Drive • Dover, NH 03820 USA • Phone: (603) 749-6434 • Fax: (603) 742-2346
www.aemc.com