

Rosemount 5300 Series

Commissioning and Validation Procedures for Rosemount Radar



Rosemount 5300 Series

⚠ WARNING

Failure to follow safe installation guidelines could result in death or serious injury.

- Only qualified personnel should install the equipment.
- Use the equipment only as specified in this guide and the Reference Manual. Refer to the Rosemount 5300 Series Reference Manual (document number 00809-0100-4530) for more instruction.

Explosions could result in death or serious injury.

- Installation of device in an explosive environment must be in accordance with appropriate local, national and international standards, codes, and practices.
- Ensure device is installed in accordance with intrinsically safe or non-incendive field practices.

Electrical shock could result in death or serious injury.

- Avoid contact with the leads and terminals. High voltage that may be present on leads can cause electrical shock.
- Make sure the main power to the Rosemount 5300 Series Transmitter is off and the lines to any other external power source are disconnected or not powered while wiring the transmitter.

Process leaks could result in death or serious injury.

- Handle the transmitter carefully.
 - If the process seal is damaged, gas could escape from the tank when removing the transmitter head from the probe.
-

⚠ CAUTION

Any substitution of non-authorized parts or repair, other than exchanging the complete transmitter head or probe assembly, may jeopardize safety and is prohibited.

Unauthorized changes to the product are strictly prohibited as they may unintentionally and unpredictably alter performance and jeopardize safety. Unauthorized changes that interfere with the integrity of the welds or flanges, such as making additional perforations, compromise product integrity and safety. Equipment ratings and certifications are no longer valid on any products that have been damaged or modified without the prior written permission of Emerson Process Management. Any continued use of product that has been damaged or modified without prior written authorization is at the customer's sole risk and expense.

Contents

Section 1: Introduction

1.1 Manual overview	1
1.2 Tools	1
1.3 Documents	1

Section 2: Installation and Configuration

2.1 Complete the Quick Start Guide	3
2.2 Complete the basic configuration	3
2.2.1 Basic configuration parameters	3
2.2.2 Basic configuration using Rosemount Radar Master (RRM)	5
2.2.3 Basic configuration using a Field Communicator	6
2.2.4 Basic configuration using AMS [®] Suite (HART) or DeltaV [™]	7
2.3 Complete the advanced configuration	7
2.3.1 Trim Near Zone	7
2.3.2 Other optional advanced configurations	8
2.4 Read measurements and output	8
2.4.1 Review measurement data	8
2.4.2 Verify analog output (HART devices only)	9
2.4.3 Review echo curve	10
2.5 Common problems and recommended actions	11
2.5.1 Double bounce	11
2.5.2 Strong fixed echo - bent probe/probe contacting nozzle	12
2.6 Archive files	14

Section 3: Verification and Validation of GWR without Fluid

3.1 Verification	15
3.2 Validation of device	20

Section 4: Verification Procedure with Fluid

4.1 Verification procedure with active level measurement	23
4.2 Common problems and recommended actions	25
4.3 Transmitter diagnostics review	27
4.4 Monitor level while emptying	27
4.5 Echo curve verification with empty tank	29
4.6 Monitor level while filling	29
4.7 Archive files	29

4.7.1 Other validation suggestions30

Section 5: Additional Options

5.1 Introduction31
5.2 Signal Quality Metrics (SQM)31
5.3 Verification reflector32
 5.3.1 High level supervision33
 5.3.2 Limitations for verification reflector33

Section 6: SIS Installations

6.1 Installation in SIS applications35
6.2 Configuring in SIS applications36
6.3 SIS operation and maintenance.....37
 6.3.1 Proof test37

Appendix A: Commissioning Checklist

A.1 Plant information41
 A.1.1 General information.....41
 A.1.2 Tank information42
 A.1.3 Mechanical installation43
 A.1.4 Electrical installation44
 A.1.5 Is the product's Ex classification in accordance with requirements?.....45
A.2 Echo tuning46
A.3 Backups and plots46
A.4 GWR radar verification in chambers47

Section 1 Introduction

1.1 Manual overview

This manual provides commissioning, verification, and validation information for the Rosemount 5300 Series Radar Transmitters.

This manual is intended to be used with the Rosemount 5300 Series Reference Manual (document number 00809-0100-4530).

1.2 Tools

The following tools and documents are recommended to use during the installation and commissioning procedures:

- Field Communicator 475/laptop with Rosemount Radar Master (RRM) or AMS[®] Device Manager
- HART[®] modem/FOUNDATION[™] fieldbus modem
- Multimeter
- Screw driver, Phillips 2 mm or flat head 6 mm (for wire terminals)
- Screw driver, flat head 8 mm (for external ground screw)
- Adjustable spanner (for cable glands)
- Wrench, 54 mm (to install or remove the transmitter head)
- Allen key, 3 mm, 4 mm, and 5 mm (to loose and fix the weight)
- Allen key, 2 mm (to secure the coaxial probe)
- Hack saw (to shorten the rigid probes)
- Heavy duty nipper (to shorten the flexible probes)

1.3 Documents

Rosemount 5300 Series Superior Performance Guided Wave Radar Level and Interface Transmitter Quick Installation Guide
(document number 00825-0100-4530)

Rosemount 5300 Series Superior Performance Guided Wave Radar Reference Manual
(document number 00809-0100-4530)

Rosemount 5300 Series - Using Guided Wave Radar for Level in High Pressure Steam Applications Technical Note
(document number 00840-0100-4530)

Section 2 Installation and Configuration

Complete the Quick Start Guide	page 3
Complete the basic configuration	page 3
Complete the advanced configuration	page 7
Read measurements and output	page 8
Common problems and recommended actions	page 11
Archive files	page 14

2.1 Complete the Quick Start Guide

Mount the transmitter, connect wiring, and power up as described in the 5300 Quick Start Guide (document number 00825-0100-4530).

2.2 Complete the basic configuration

2.2.1 Basic configuration parameters

- HART®/FOUNDATION™ fieldbus address
- Device tag
- Measurement units
- Tank geometry

Figure 2-1. Tank Geometry

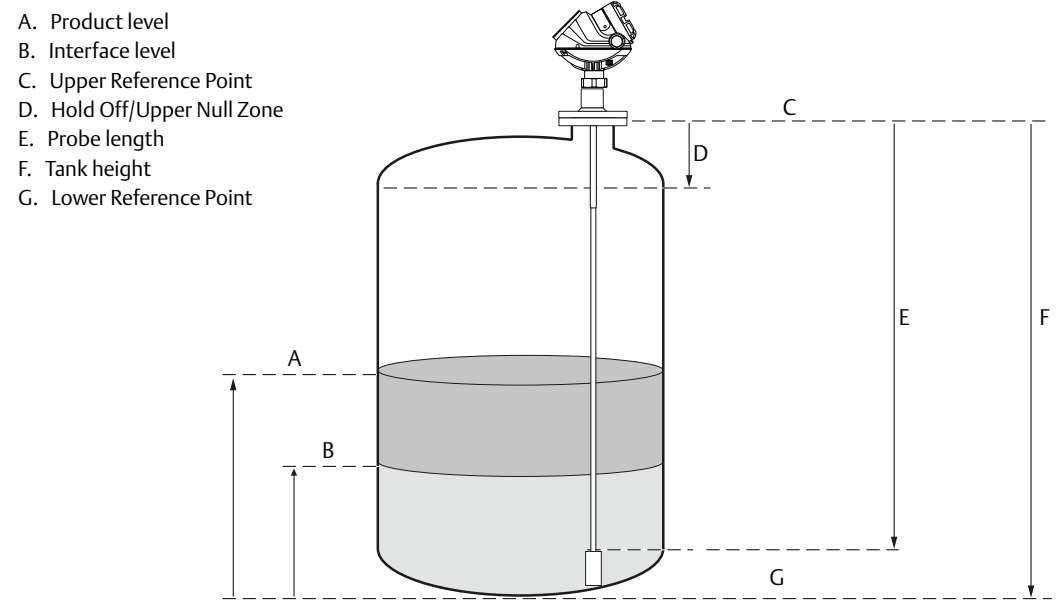

- Probe type
- Hold Off/Upper Null Zone. This parameter should only be changed if there are disturbing objects close to the probe, e.g. nozzle disturbances. No valid measurements are possible above the Hold Off Distance.
- Measurement mode
- Rapid level changes
- Dielectric constant
- Volume configuration. For volume calculations, you can select one of the standard tank shapes or the strapping option. Select **None** if volume calculation is not used.
- Analog output (HART)

Figure 2-2. Illustration of Analog Output (HART) Parameters

- A. 20mA
- B. Range 0 -100%
- C. 4mA
- D. Lower Reference Point
- E. Upper Reference Point
- F. Upper Blind Zone
- G. Reduced accuracy
- H. Reduced accuracy
- I. Lower Blind Zone

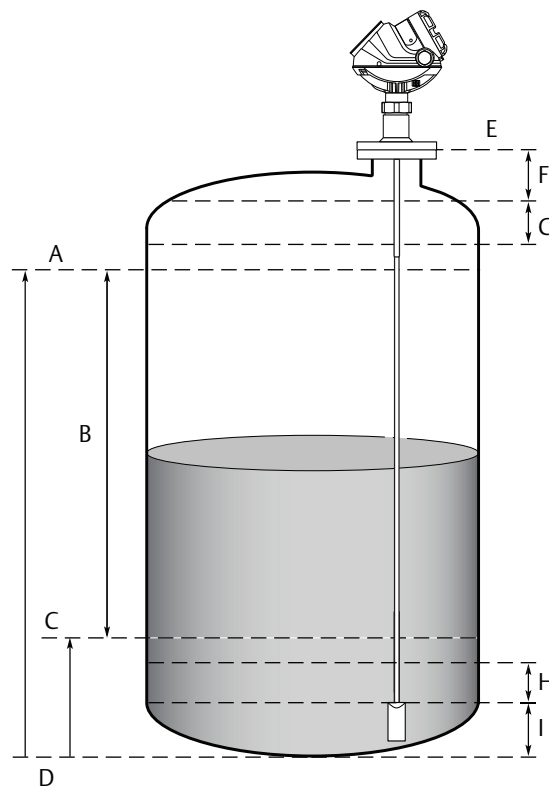

For more information, see Section 5: Configuration in the Rosemount 5300 Series Reference Manual (document number 00809-0100-4530).

- AI block (FOUNDATION fieldbus). A minimum of four parameters are required to configure the AI Block.
 - **Channel** - Corresponds to the desired sensor measurement
 - **L_TYPE** - Defines the relationship to the desired output of the AI Block. Direct or indirect root.
 - **XD_SCALE** - Include 0%, 100%, and engineering units
 - **OUT_SCALE** - Include 0%, 100%, and engineering units

For more information, see Section 5.9 FOUNDATION fieldbus Overview and Appendix E Level Transducer block in the Rosemount 5300 Series Reference Manual (document number 00809-0100-4530).

2.2.2 Basic configuration using Rosemount Radar Master (RRM)

1. Start the Guided Setup.
2. Start the Configuration Wizard.
3. Select the Device specific setup to see if any additional configuration is needed.
4. Restart the Device.
5. Run Verify level.
6. Select Archive Device to make a complete backup of the device, including several logs, and echo curves.
7. View live values from the device.

For more information, see Section 5.6 in the Rosemount 5300 Series Reference Manual (document number 00809-0100-4530).

2.2.3 Basic configuration using a Field Communicator

Figure 2-3. Field Communicator Menu Tree Corresponding to Device Revision 3

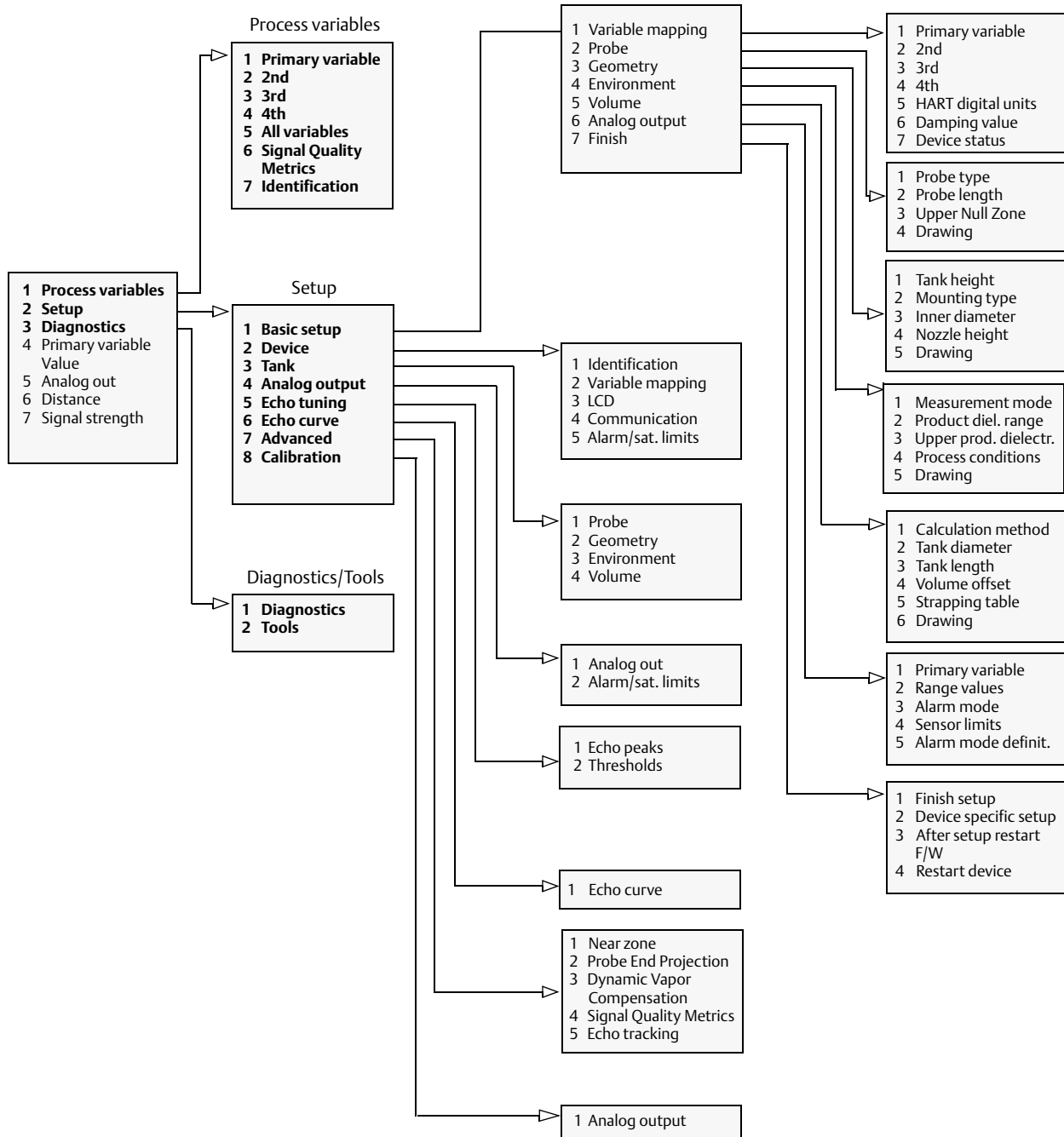

For more information, see Section 5.5 Basic configuration using a Field Communicator in the Rosemount 5300 Series Reference Manual (document number 00809-0100-4530).

2.2.4 Basic configuration using AMS[®] Suite (HART) or DeltaV[™]

The Rosemount 5300 Series can also be configured using AMS Suite or DeltaV.

For more information, see Section 5.7 Basic Configuration Using AMS Suite (HART) in the Rosemount 5300 Series Reference Manual (document number 00809-0100-4530).

2.3 Complete the advanced configuration

For more information, see Appendix C.3: Advanced Configuration in the Rosemount 5300 Series Reference Manual (document number 00809-0100-4530).

2.3.1 Trim Near Zone

Note

Trim Near Zone should not be performed on Dynamic Vapor Compensation or Coaxial probes.

Use Trim Near Zone when mounted in a nozzle, chamber, or still-pipe. An exception is narrow nozzles as defined below:

- 2 in. (50 mm) < Nozzle height < 12 in. (300 mm)
- Nozzle diameter < 2 in. (50 mm) for all single probes
(Nozzle diameter < 3 in. (75 mm) for 13 mm single rigid)

To complete the Trim Near Zone function:

1. Make sure the product level is below the near zone region (3.3 ft [1 m] from the flange face).
2. Select Trim Near Zone and follow the instructions.

Note

Trim Near Zone should not be completed when the unit is installed in an empty metal tank. A small amount of fluid should be added before the Trim Near Zone step is completed.

2.3.2 Other optional advanced configurations

Other functions that may be required can be found in Appendix C of the reference manual. Some of these may only be needed in certain conditions. This includes settings for:

- Hold Off Distance/Upper Null Zone which defines how close to the upper reference point a level value is accepted. This will block out false targets and measurements in this area.
- Threshold settings which determine the minimum signal amplitude limits of key parameters such as the surface echo, interface echo, reference peak and end of probe peak.
- Probe End Projection is used to support the surface measurement in low dielectric materials and when the surface is close to the end of the probe.
- Echo tracking may be needed to enhance the measurement tracking capabilities in some conditions such as rapid level changes or excessive turbulence
- Dielectric constant settings may need adjustment in interface or saturated steam applications.
- Dynamic Vapor Compensation is used in saturated steam applications with a probe that includes a steam compensation reflector.
- Signal Quality Metrics are used to indicate the integrity of the surface signal compared to the noise. It could be used to detect excessive coating on the probe or the presence of some heavy foams.

2.4 Read measurements and output

2.4.1 Review measurement data

To view measurement data such as level, signal strength, etc. in Rosemount Radar Master, select the **Tools > Device Display** option and select the **Level** tab.

Figure 2-4. Presentation of Measurement Data in Rosemount Radar Master

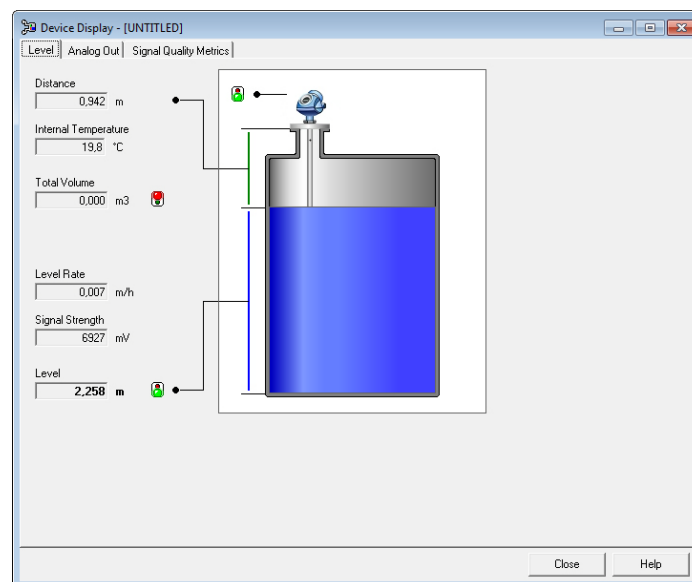

To view the analog output signal, select the **Tools > Device Display** option and select the **Analog Out** tab:

Figure 2-5. Presentation of Analog Output Value in Rosemount Radar Master

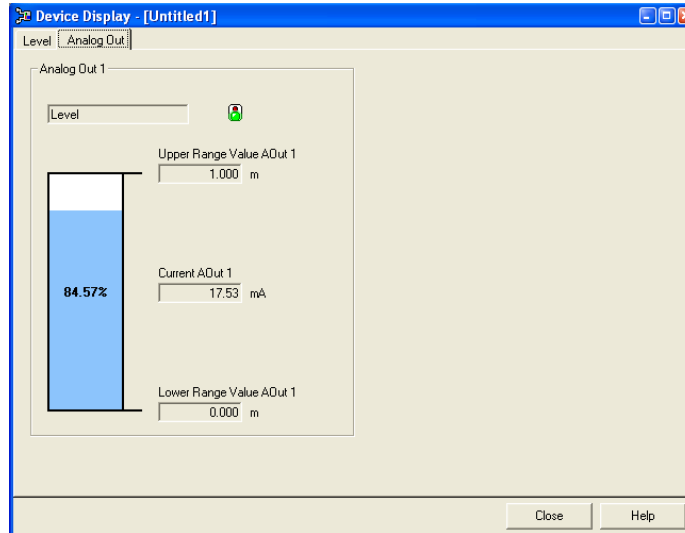

For more information, see Section Viewing Measurement Data In Rosemount Radar Master in the Rosemount 5300 Series Reference Manual (document number 00809-0100-4530).

2.4.2 Verify analog output (HART devices only)

Ensure the loop is set to manual mode in the Distributed Control System (DCS) for the applicable transmitter.

Use the transmitter's built-in simulation mode to test the analog output settings. Output at least one arbitrary level or interface and verify that the readings in the DCS match up.

In Rosemount Radar Master, select **Tools > Simulation Mode**.

Figure 2-6. Simulation Mode

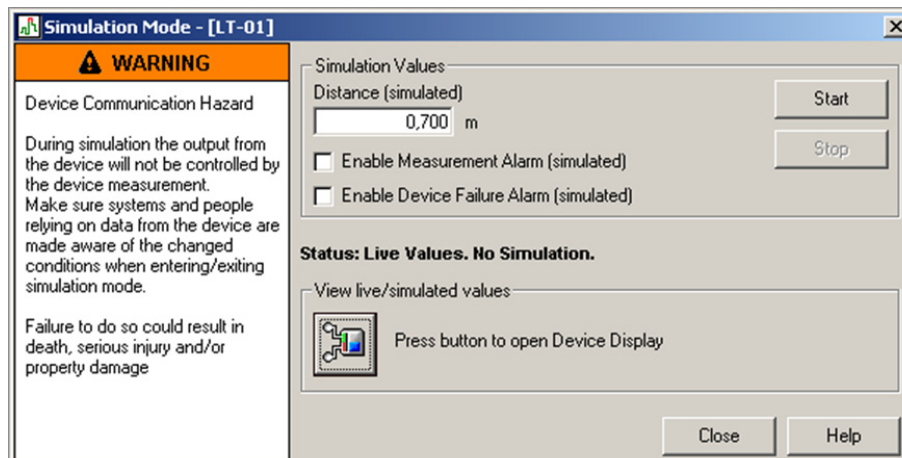

Also, or alternatively, activate the transmitter's loop test function. Output 4, 12, and 20 mA and verify that the readings in the DCS match up.

In Rosemount Radar Master, select Setup > **Output** > **Analog Out 1** and click **Loop test**.

Figure 2-7. Loop Test for Analog Out 1

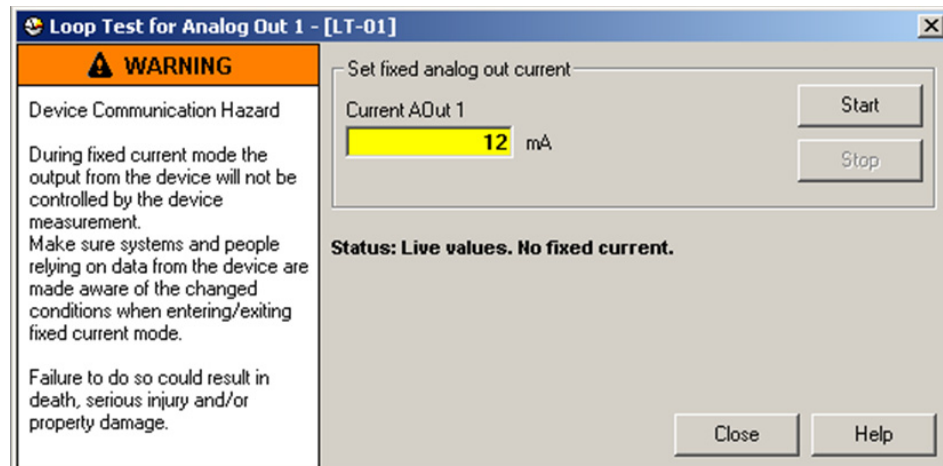

2.4.3

Review echo curve

1. Download and review the echo curve
2. Verify that the reference pulse is detected
3. Review peak amplitudes
 - For an empty vessel, verify the probe end pulse is visible. If the probe is grounded (the end of the probe is touching a metal surface) or SST centering disk is used, the pulse is positive. Otherwise the pulse will be negative.
 - Verify that no disturbing echoes are present above the Surface Threshold (ATC).

Note

Figure 2-8 illustrates the key elements of a theoretical echo curve. In an actual echo curve, the probe end pulse and the probe end echo threshold line are not visible in an interface application, they are shown for illustration purposes only.

Figure 2-8. The Echo Curve Presents All Visible Echoes

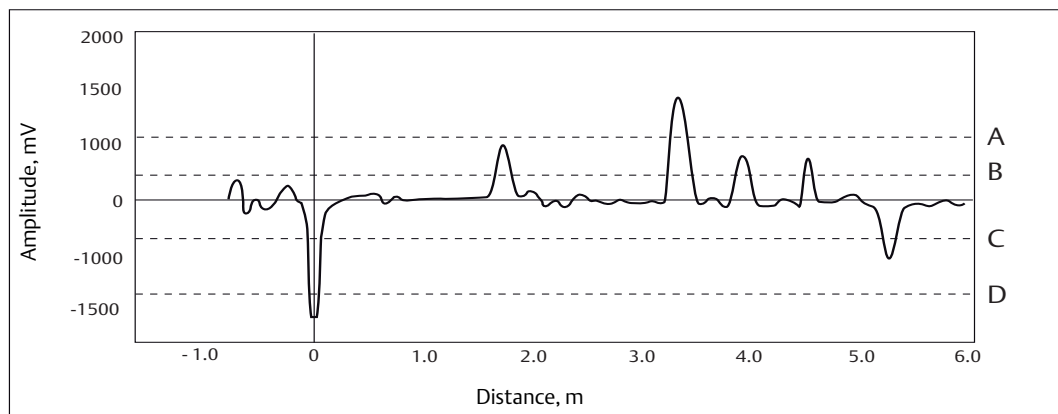

- A. Interface threshold
- B. Surface threshold (ATC)
- C. Probe end threshold
- D. Reference threshold

2.5 Common problems and recommended actions

2.5.1 Double bounce

Tall, narrow, and/or rough nozzles may create double bounces, which disturb the measurement signal. The double bounce always appears at twice the disturbance distance. For example, the end of the nozzle may create a peak at 10 in. (254 mm). A second peak will appear at 20 in. (500 mm).

Note

Trim Near Zone should not be completed when the unit is installed in an empty metal tank. A small amount of fluid should be added before the Trim Near Zone step is completed.

Recommended actions:

- Verify that mounting considerations are followed, as described in Section 3.2 Mounting Considerations in the Rosemount 5300 Series Reference Manual (document number 00809-0100-4530).
- Perform Trim Near Zone. See Appendix C.3.1 Use the Trim Near Zone Function in the Rosemount 5300 Series Reference Manual (document number 00809-0100-4530) for activation details. Fine-tune performance by trimming echoes in the near zone.
- Adjust Upper Null Zone (UNZ). See Appendix C.3.2 Changing the Hold Off Distance/Upper Null Zone in the Rosemount 5300 Series Reference Manual (document number 00809-0100-4530) for details. Exclude any echo “before” the UNZ.
- Adjust Surface Threshold (ATC). See Appendix C.4 Threshold Settings in the Rosemount 5300 Series Reference Manual (document number 00809-0100-4530) for details. Exclude any echo weaker than the threshold.

2.5.2 Strong fixed echo - bent probe/probe contacting nozzle

A probe in contact with metal creates a strong echo and the measurement will lock onto the strong echo.

Note

Heavy contamination may also create strong disturbance echoes.

Figure 2-9. Echo Curve with a Bent Probe

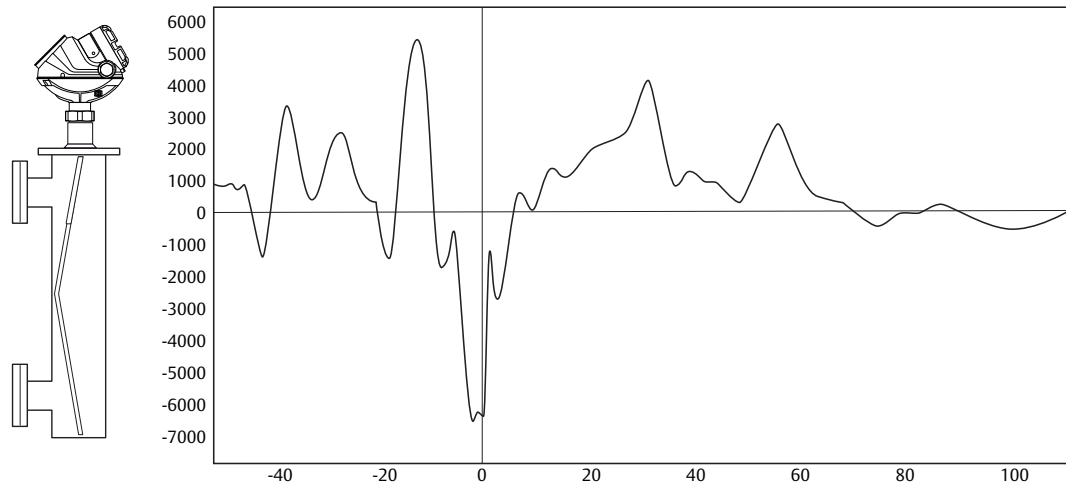

Recommended actions:

- If bent probe, try to straighten it gently. If this is not possible, a replacement of the complete probe assembly may be required.
- Verify that mounting considerations described in Section 3.2.5 Mounting in Chamber/Still Pipe in the Rosemount 5300 Series Reference Manual (document number 00809-0100-4530) are fulfilled. The probe length should be slightly shorter than the chamber length.
- Consider adding a centering disc at the bottom of the probe. For more information, see Section 3.3.9 Mounting a Centering Disc for Pipe Installations in the Rosemount 5300 Series Reference Manual (document number 00809-0100-4530). This helps to keep the probe centered in the chamber/still-pipe.
- If flexible probe in contact with nozzle, consider using a long stud. For more information, see Section 3.2 Mounting Considerations in the Rosemount 5300 Series Reference Manual (document number 00809-0100-4530).

Read diagnostics

Verify that no errors or unattended warnings are present.

Figure 2-10. The Diagnostics Window in Rosemount Radar Master

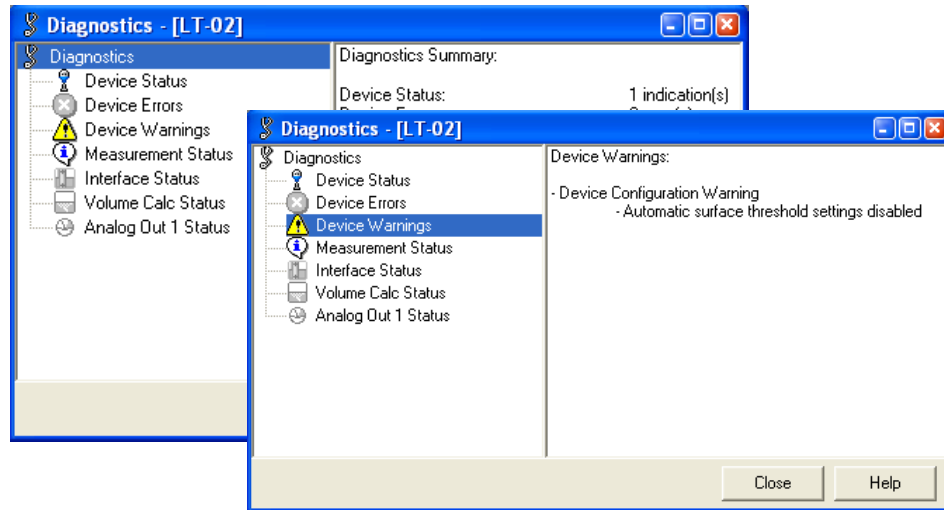

To view Diagnostics in Rosemount Radar Master, select **Tools > Diagnostics**.

For more information, see Section 7.14 Diagnostics in the Rosemount 5300 Series Reference Manual (document number 00809-0100-4530).

2.6 Archive files

Save echo curve and configuration backup file

Permanently store the echo curve and configuration backup files for future use, with re-occurring verification procedures. In Rosemount Radar Master this can be done using the Archive Device step under Guided Setup. This will save configuration files and echo curves. In Rosemount Radar Master, the same files can be saved manually using these steps:

1. Select **Device > Backup Config to File**.
2. Select **Tools > Echo Curve > Record**.

Figure 2-11. The Configuration Report Window in Rosemount Radar Master

Parameter	Value	Unit
Device Information		
Protocol	HART	
Address	0	
Device Tag	LT-02	
Device Type	5300	
Version	0C2	
Unit ID	16777215	
Factory Setup		
My Address1	-1	
Txl	1.814	m
Rel Impulse Ampl	16.299999	
Timing Calib	205	
Nom Ref Pulse Dist	1.960	m
Nom Ref Pulse Ampl	807	mV
Mainboard Serial No	-1	
NL Gain Fac	7.5	
Protected parameters		
Probe Type	Rigid Twin	
Probe Length	1.070	m
HART Specific Setup		
Date	2007-05-07	
Message	MSG	
Descriptor	DESC	
Tag	LT-02	

Section 3 Verification and Validation of GWR without Fluid

Verification	15
Validation of device	20

3.1 Verification

1. Install unit, configure for application, and view echo curve.
 The echo curve should be saved from -3 ft (-1 m) to 3 ft (1 m) beyond the reference height.
2. Verify that the unit reads correctly while the chamber is empty.
 The unit can be set up to read 4 mA as zero level when the chamber is empty. Or, it may read saturation value of 3.8 mA when the level is sufficiently below the zero level.
3. On the echo curve, note the following:

Figure 3-1. Echo Curve with Key Components Identified

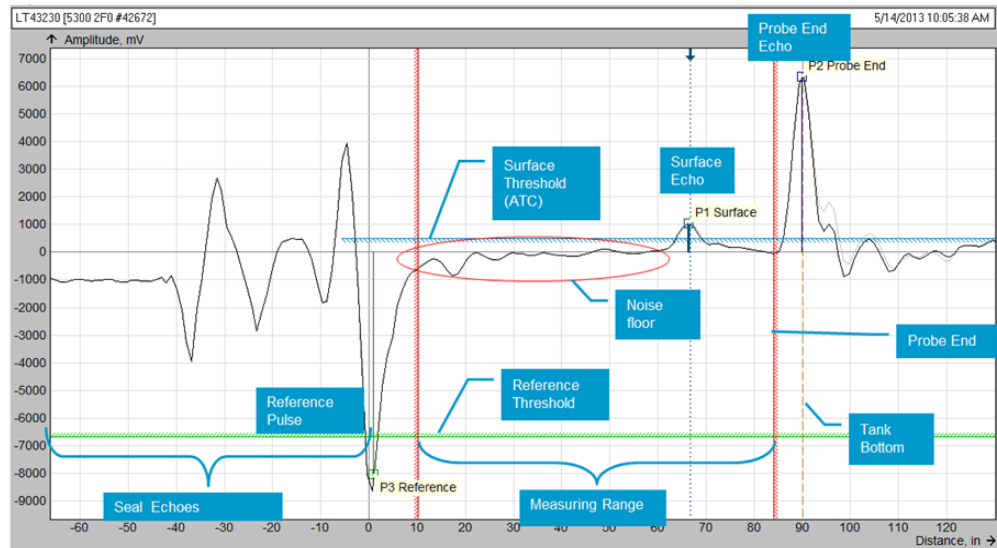

- a. Reference pulse amplitude and location with regard to the zero line (see Table 3-1)

Reference pulse amplitude varies with the type of probe used and the size of the chamber.

Table 3-1. Reference Peak Examples

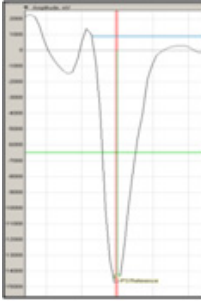
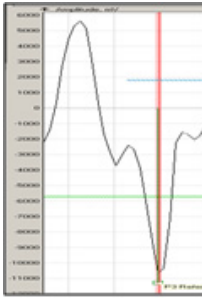
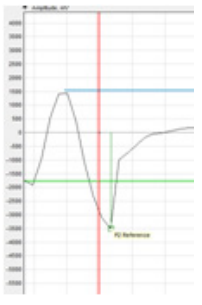
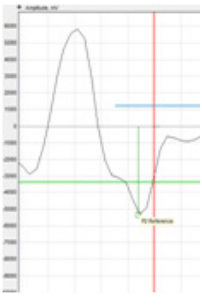
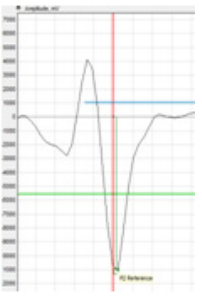
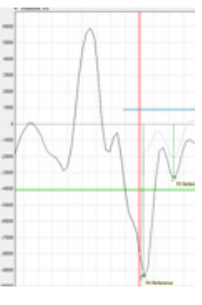
Single probe, standard	Single probe, HTHP	Coaxial Standard	Coaxial HTHP	Twin Standard	DVC probe
Amplitude 1200-16000 mV	Amplitude 9000-11000 mV	Amplitude 5000-7000 mV	Amplitude 5000-7000 mV	Amplitude 9000-11000 mV	Amplitude 8000-11000 mV
					

- b. General noise floor amplitude (see Figure 3-2)

The noise floor should be relatively flat with low amplitude. This can vary with the size and shape of the chamber internal structure. For example, some inlet connections may have a rough weld edge and this can result in a small disturbance on the echo noise floor. In general, the noise floor should be relatively flat and below the general threshold setting.

Figure 3-2. Noise Floor Examples when Vessel is Empty

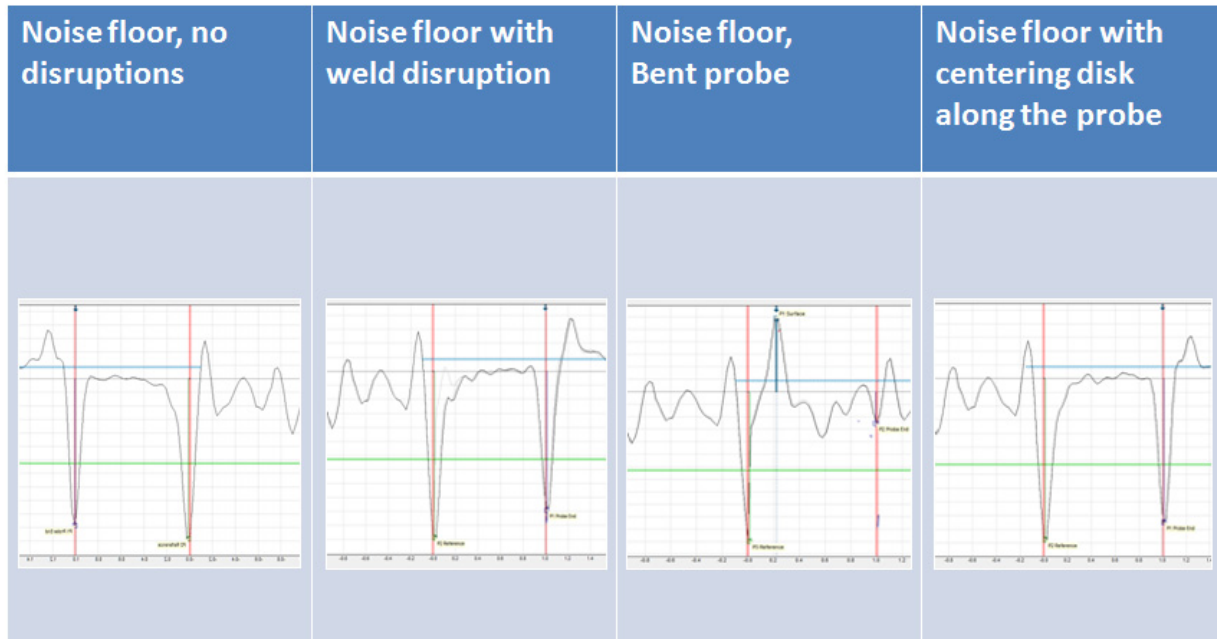

- c. End of probe peak (see Figure 3-3)

The end of probe peak is affected by the probe type and the use of centering discs. A metal centering disc will give a positive peak slightly offset from the probe end. No centering disc or a non-metallic centering disc will result in a negative probe end peak.

Figure 3-3. End of Probe Peaks

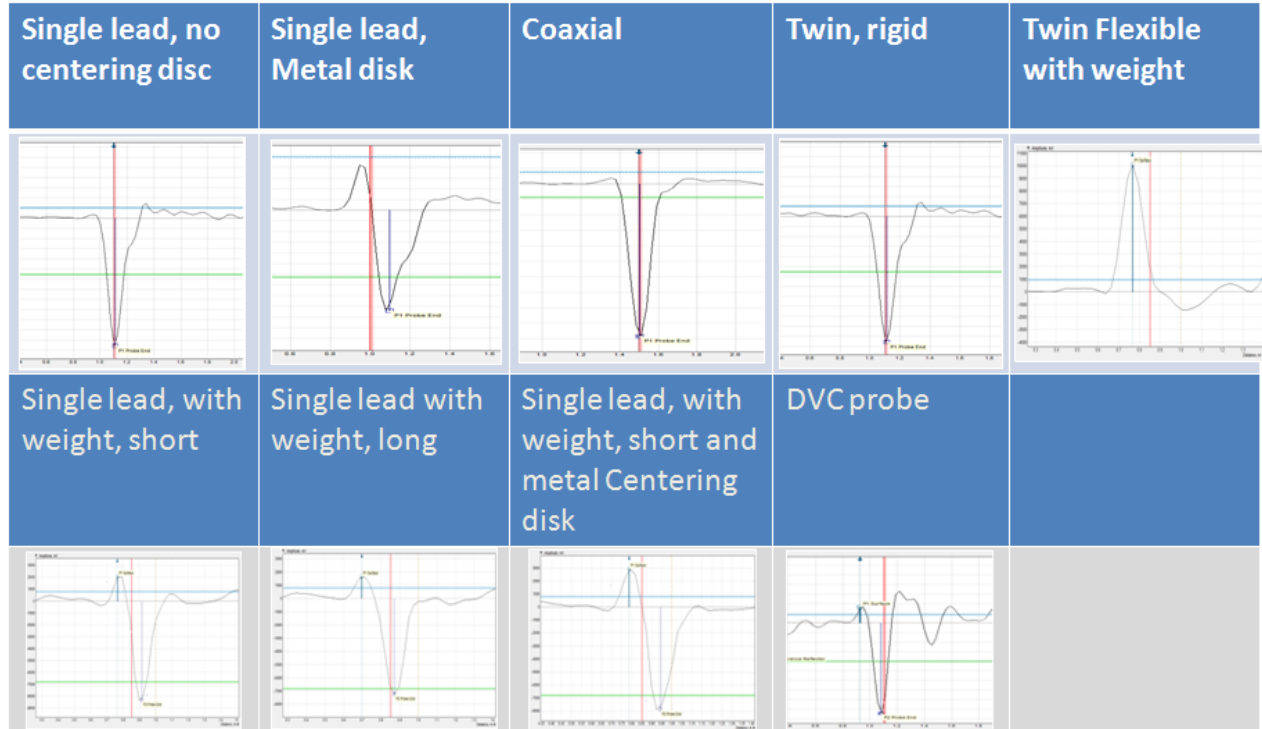

The use of weights will result in a positive peak at the top of the weight and a negative peak at the bottom. The distance between the positive and negative peak varies with the length of the weight.

- 4. (Optional) If using a verification reflector, note location of reflector pulse (see Figure 3-4) please see “Verification reflector” on page 32 for more detail. Perform verification test and note mA output.

Figure 3-4. Sample Verification Reflector Peak

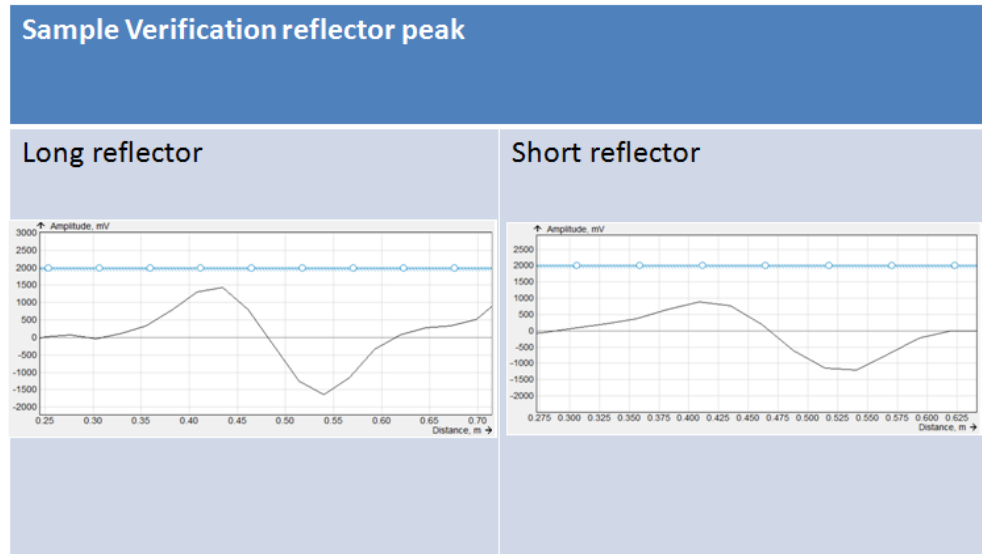

5. While the chamber is empty, save backup file and echo plot.
 - Use the archive function in Rosemount Radar Master. Select **Setup > Guided Setup > Archive** or **Device > Archive Device**.
 - Rosemount Radar Master will save zipped files to a designated folder and will use the tag number, base model, firmware revision, serial number, date and time of the device for identification.
Example: LT_201_5300_2J0_#2158762-2014-10-28_1656.

3.2 Validation of device

To validate the functionality of a device after it has been in service, it is possible to compare the current readings to baseline readings. To obtain the current readings, follow the same steps that were outlined under verification. A new set of files showing the configuration data and the echo curves should be obtained and compared to the initial set.

Note

Files may be viewed offline by using the 'Backup File Reader' and 'Plot Viewer' tools that are supplied with Rosemount Radar Master.

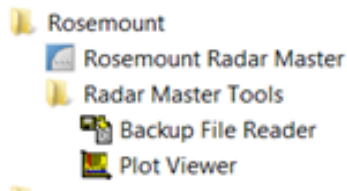

-
1. Ensure chamber is empty.
 2. Take and save an echo curve of the device in the empty chamber.
 3. Compare new curve to original noting the following:
 - Amplitude and location of reference peak
 - General noise floor profile
 - End of probe peak
 - Verification reflector location
 4. (Optional) Perform verification reflector test and note mA output.

Table 3-2. Validation Checks

Description	Initial reading	Validation reading	Allowable Tolerance
Reference peak amplitude			Normal variation is $\pm 10\%$ mostly depends on the ambient temperature. If the initial measurement was performed in one of the extreme temperature and the validation measurement is performed at the other extreme can amplitude differ 20%
Reference peak zero point			± 1 mm
Internal reference pulses			See Reference peak amplitude Position: ± 5 mm
Noise floor amplitude			500 mV below surface threshold
Noise floor: any distinctive peak, distance and amplitude			See Noise floor amplitude tolerance
Probe end amplitude			See Reference peak amplitude
Probe end position			Accuracy ± 0.12 in. (3 mm) or 0.03% of measured distance, whichever is greatest Ambient Temperature Effect ± 0.008 in. (0.2 mm)/K or ± 30 ppm/K of measured value, whichever is greatest
Verification Reflector, Amplitude, distance, mA output			See “Reference Peak Amplitude” and “Probe End Position” tolerance

Tag# _____

Serial# _____

Parameter		Initial Value	Current value	Tolerance	Within tolerance? (Yes or No)
Date					
Temperature of chamber					
LRV (4 mA setting)					
URV (20 mA setting)					
Reference peak	Amplitude			$\pm 10\%$ ⁽¹⁾	
Reference peak	Zero point position			± 1 mm	
Seal pulse peaks					
Peak 1	Amplitude			$\pm 10\%$ ⁽¹⁾	
	Position			± 5 mm	
Peak 2	Amplitude			$\pm 10\%$ ⁽¹⁾	
	Position			± 5 mm	
Peak 3	Amplitude			$\pm 10\%$ ⁽¹⁾	
	Position			± 5 mm	
Noise floor	General amplitude			500 mV below surface threshold	
Noise floor	Distinctive peak 1: distance				
	Amplitude			500 mV below surface threshold	
	Distinctive peak 2: distance				
	Amplitude			500 mV below surface threshold	
End of probe peak	Direction				
End of probe peak	Distance			± 0.12 in. (3 mm) or 0.03% of measured distance, whichever is greatest ⁽²⁾	
End of probe peak	Amplitude			$\pm 10\%$ ⁽¹⁾	
Verification reflector	Distance			± 0.12 in. (3 mm) or 0.03% of measured distance, whichever is greatest ⁽²⁾	
Verification reflector	Amplitude			$\pm 10\%$ ⁽¹⁾	
Verification reflector	mA Output				

(1) Normal variation of peak amplitude is $\pm 10\%$ and depends on the ambient temperature. If the initial measurement was performed in one extreme temperature and the validation measurement is performed at the other extreme, the amplitude can differ by as much as 20%.

(2) Ambient temperature effect ± 0.008 in. (0.2 mm) /K or ± 30 ppm/K of measured value, whichever is greatest.

Section 4 Verification Procedure with Fluid

Verification procedure with active level measurement	page 23
Common problems and recommended actions	page 25
Transmitter diagnostics review	page 27
Monitor level while emptying	page 27
Echo curve verification with empty tank	page 29
Monitor level while filling	page 29
Archive files	page 29

4.1 Verification procedure with active level measurement

At normal operating conditions, compare the transmitter level, or interface reading, with an independent measurement. Unfortunately, it often happens that two independent measurements do not match up perfectly, but check the sanity and the acceptable deviation.

Verify the correctness of level reading

The independent measurement can be done using a number of different complementary devices, ranging from sight-glasses and hand-dipping to redundant differential pressure and displacer transmitters.

Figure 4-1. The Verification of Measurement Data Using a Sight-glass

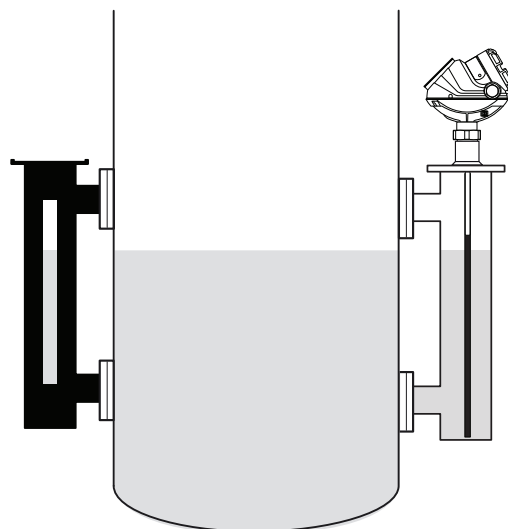

Echo curve verification at operating conditions

At normal operating conditions, download and review the echo curve according to the following steps:

1. Check reference pulse amplitude and position. Compare the result against the previous plots, taken during cold startup.
2. Review peak amplitudes and threshold settings. Verify that the surface and/or interface peaks are visible and that the thresholds have been set as described in threshold settings. See Table 4-1 below for rough guidelines of amplitudes. For information on threshold settings, see “Common problems and recommended actions” on page 25.
3. Store the echo curve for future use.

Figure 4-2. Peak Amplitudes and Threshold Settings

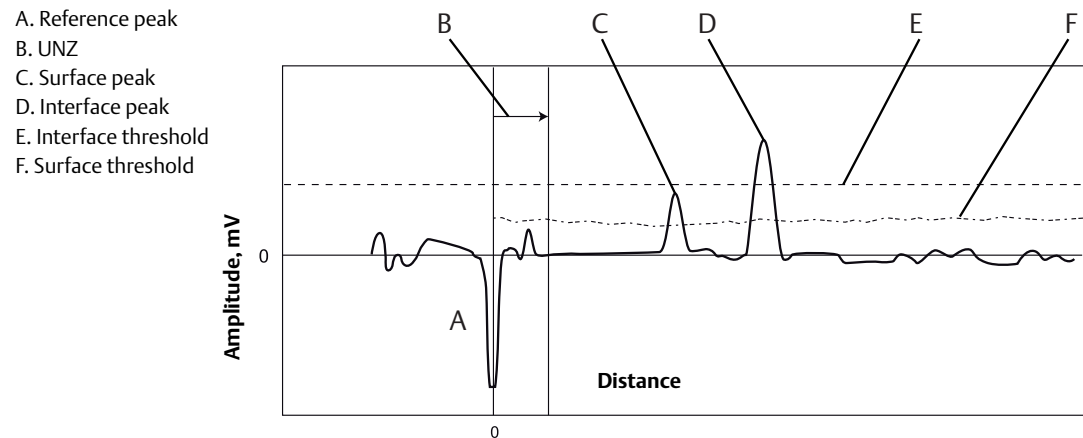

Table 4-1. Typical Peak Amplitudes for Rosemount 5300 Series with Single Lead High Pressure Probe in 4-in. Chambers

Peak	Approximate signal strength, ideal conditions for single lead probe in 4 in. (100 mm) chambers
Reference peak	~10,000 mV ⁽¹⁾
Surface peak, 5301 with oil (DC=2)	~2,000 mV
Surface peak, 5301 with water (DC=80) at 3 ft (1 m) distance	~10,000 mV
Interface peak, 5302 with oil and water	~8,000 mV

(1) This value does not apply and may be considerably lower when the probe is completely submerged in product.

For additional information and signal amplitude, refer to Section C.4 Threshold settings (document number 00809-0100-4530)

4.2 Common problems and recommended actions

Surface pulse not detected

Figure 4-3. Surface Threshold too High

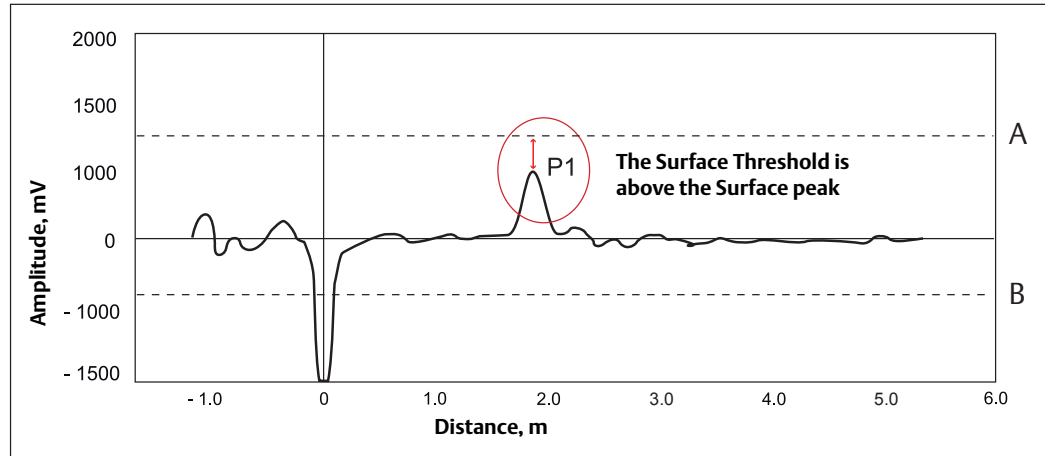

A. Surface Threshold= Amplitude Threshold Curve (ATC)
B. Reference Threshold

Surface measurement is too high

Figure 4-4. Surface Threshold too Low

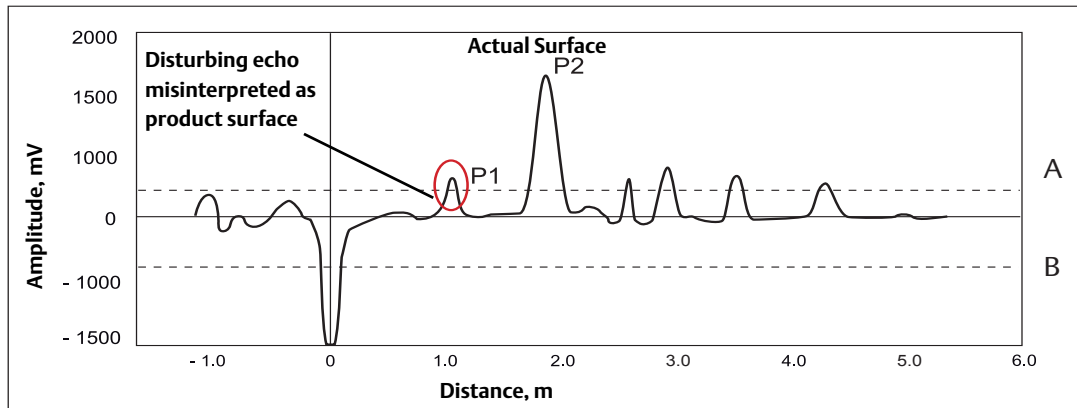

A. Surface Threshold= Amplitude Threshold Curve (ATC)
B. Reference Threshold

Recommended actions

Any of these options may be used to block false echoes:

- Raise general surface threshold to about 300 mV above false echo, but not more than 50% of height of surface peak.

Interface peak not found

Figure 4-5. Echo Curve Plot Indicating Amplitude Threshold for the Interface Peak too High

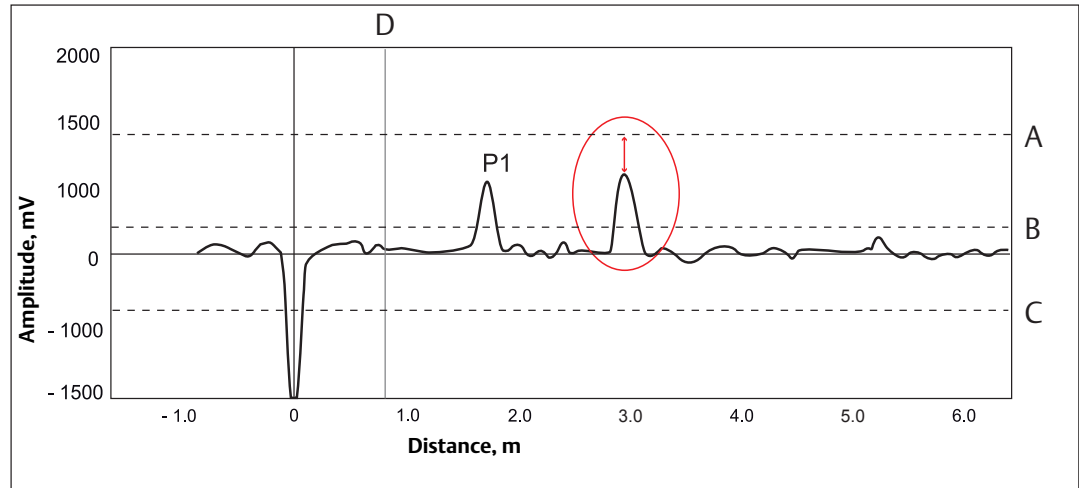

- A. Interface Threshold
- B. Surface Threshold
- C. Reference Threshold
- D. UNZ

If the interface threshold is too high, the signal amplitude peak at the interface between the upper and lower products is not detected.

Recommended actions

Lower interface threshold, to a level that is 50% of the interface peak.

4.3 Transmitter diagnostics review

Verify that no errors or unattended warnings are present.

Figure 4-6. The Diagnostics Window in RRM

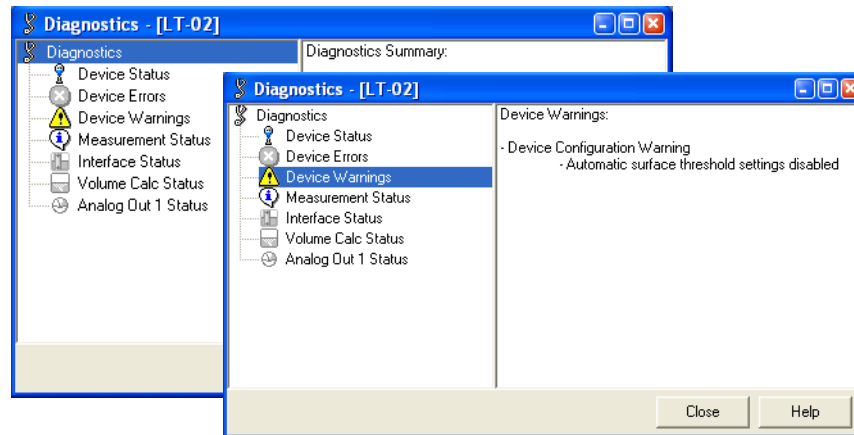

To view Diagnostics in RRM, select **Tools > Diagnostics**.

For more information, see Section Diagnostics in the Rosemount 5300 Series Reference Manual (document number 00809-0100-4530)

4.4 Monitor level while emptying

During Step 1, the current level/interface reading was verified correct. This step verifies that the transmitter correctly tracks the surface during the emptying of the tank.

Begin by activating log functionality for the transmitter level/interface output. Either the DCS-trend or a standalone tool can be used.

In RRM, select **Tools > Log**.

Figure 4-7. Log Registers

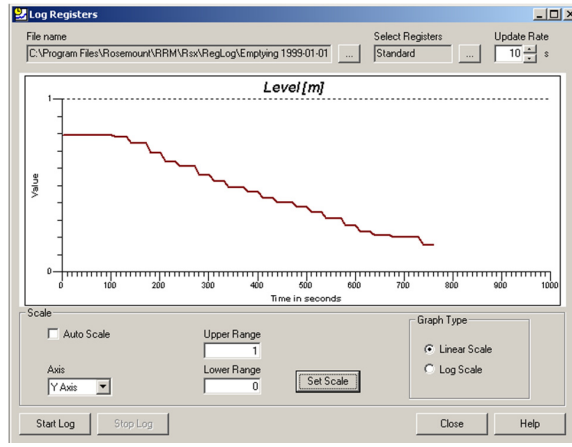

Start emptying the tank or chamber making sure not to stop until it is completely empty. With a chamber, do not forget to close the process valves before draining.

Figure 4-8. Emptying a Tank or a Chamber

- A. Valves
- B. Vent
- C. Drain

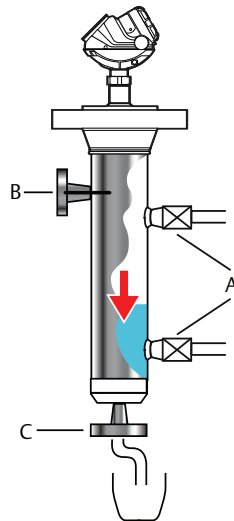

For emptying a tank or a chamber:

1. Close valves.
2. Open vent.
3. Open drain.
4. Review the level/interface trend for accuracy.

4.5 Echo curve verification with empty tank

When the tank or chamber is empty, download and review the echo curve according to the following steps:

1. Compare the echo curve with previous plots, taken during commissioning. There should be no major differences. Especially make sure to review:
 - The amplitude and position of the reference pulse
 - If all noise is below the threshold
 - The amplitude and position of the bottom or probe-end pulse
2. Store the echo curve for future use.

4.6 Monitor level while filling

Repeat “Monitor level while emptying” on page 27, but fill the tank or chamber instead of emptying it.

4.7 Archive files

Save echo curve and configuration backup file

Permanently store the echo curve and configuration backup files for future use, with re-occurring verification procedures.

- For storing the echo curve in RRM, select **Tools > Echo Curve > Record**.
- For saving a configuration backup file in RRM, select **Device > Backup Config to File**.

Figure 4-9. The Configuration Report Window in RRM

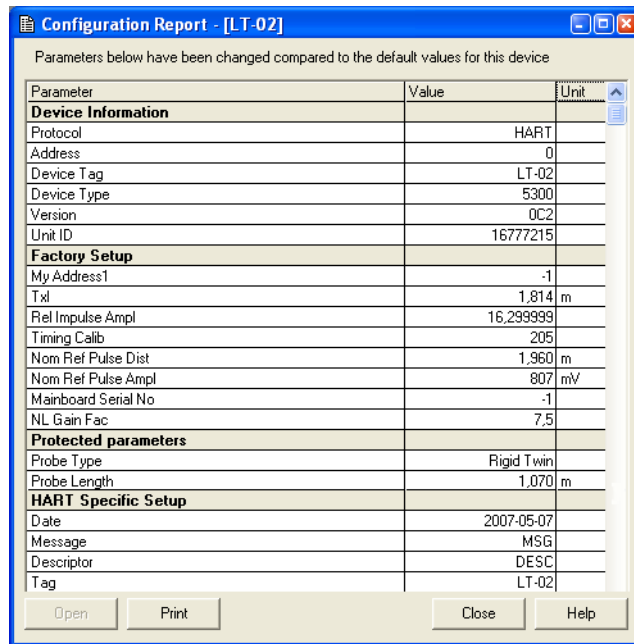

4.7.1 Other validation suggestions

To validate a device, do one of the following:

- Check the end of probe peak and label when the vessel or chamber is completely empty. Check if the peak corresponds to the EOP label. If it does not correspond, check the probe length that was used in the configuration.
- Check if there is an alternative measurement. Compare it to the GWR result. An Magnetic Level Indicator (MLI) can be used, but with the caveat that the MLI is density-dependent. For example, if the MLI float is sized to be used with oil, but the validation is completed with water, the MLI and the GWR will be offset. The GWR will track the surface regardless of the fluid density.
- If the verification reflector is present, check its location to validate a reading after the reflector calibration is complete.
- Check if SQM is used. On a clean probe and a high dielectric fluid, the signal quality value should be high (>8).
- For an interface measurement, use an alternative way to know the interface, for example a sight-glass. The DC of the upper fluid may need to be adjusted to make the interface given by the GWR match the interface from the sight glass. The dielectric calculator tool in RRM can be used to assist with this adjustment.

Section 5 Additional Options

Introduction	page 31
Signal Quality Metrics (SQM)	page 31
Verification reflector	page 32

5.1 Introduction

Additional options are available for the Rosemount 5300 that can be useful for diagnostics under operating conditions.

5.2 Signal Quality Metrics (SQM)

SQM indicates the surface signal integrity compared to the noise. It can be used to schedule maintenance to clean the probe or detect and monitor turbulence, boiling, foam, and emulsions.

The following diagnostics measurements are available:

Signal quality is a measurement of the surface peak amplitude compared to the surface threshold (ATC) and the smallest marginal between the noise and the ATC above the surface (indicated with a circle) compared to the ATC. The signal quality spans from 0 to 10, where 0 indicates a low margin, and 10 indicates a high margin. It indicates how much margin there is until the noise peak is indicated as the surface level. Surface/noise margin is the relationship between surface peak amplitude and the amplitude of the strongest noise peak above the surface. The surface/noise margin spans from 0 to 10, where 0 indicates a low margin, and 10 indicates a high margin. It indicates how much disturbance the device can handle in the tank.

Note

Since signal quality is reflective of the surface conditions, the probe, and the threshold settings, it intended to be used while the device is measuring level. It is not considered a valid parameter when the tank or chamber is empty.

Note

The signal amplitude and the noise margin depend on probe type and application conditions, as well as the condition of the probe. Even if the probe is clean, signal quality and surface/noise margin may not be a 10.

To check if the SQM function is supported, do one of the following:

- If “DA1” or “D01” is mentioned in the model code on the label, the device supports Signal Quality Metrics. Model Code: 530xxxxxxxxxxxxxxxxDA1 or 530xxxxxxxxxxxxxxxxD01xx

- In Rosemount Radar Master:
 1. Connect to the device.
 2. Right click on the device and select **Properties**.
 3. If “Diagnostics Suite” is mentioned in the *Device Software Configuration 2* list, the device supports Signal Quality Metrics.
- In a Field Communicator, if SQM is supported, it can be found with the [3, 2, 2, 1] sequence. Check if “Diagnostics Suite” is present.

SQM can be enabled/disabled in Rosemount Radar Master. Select **Setup > Advanced** and select the **Signal Quality Metrics** tab.

Note

If SQM is not supported or disabled, the signal quality and surface/noise margin will always be set to 0.

5.3 Verification reflector

The reflector, which is available with single lead flexible probes, is used to test and continuously verify that the transmitter functions properly in both tank and chamber/pipe installations. Compared to traditional diagnostics that only monitor the transmitter electronics, the reflector can also be used to diagnose the upper parts of the probe inside the tank for example build-up, corrosion monitoring, and other process related conditions.

The primary use-cases for the reflector are:

- Verification of transmitter and probe (proof-testing)
- High level supervision (continuous monitoring of high level condition)

Figure 5-1. Verification Reflector

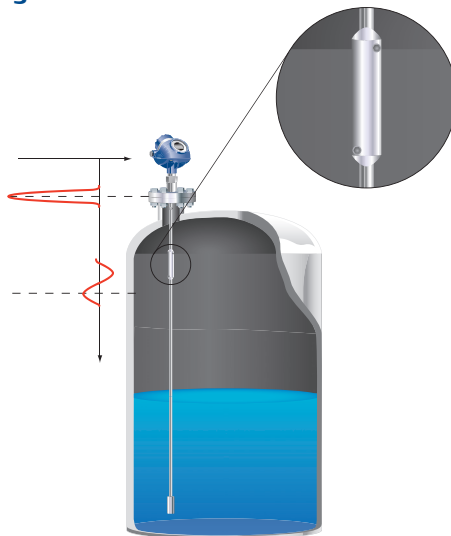

5.3.1 High level supervision

Additionally, the reflector's unique echo characteristics aid the transmitter to locate a liquid surface above the reflector, thereby offering increased reliability to detect high level conditions at a user selectable limit. The transmitter continuously monitors the status of the reflector and abnormal conditions generate alarms and alerts as appropriate.

5.3.2 Limitations for verification reflector

- Not to be used in fully submerged applications
- Minimum dielectric constant:
 - 2.4 (for option code HL1)
 - 2.0 (for option code HL2 and HL3)

Verification reflector must be installed at least 20 in. (0.5 m) below the flange face. In addition, during the calibration procedure, the level surface must be at least 20 in. (0.5 m) below the reflector.

More information

For more information and installation requirements, refer to the High Level Supervision Manual (document number 00809-0900-4530).

Section 6 SIS Installations

Installation in SIS applications	page 35
Configuring in SIS applications	page 36
SIS operation and maintenance	page 37

6.1 Installation in SIS applications

The device should be installed and configured as a level sensing device per manufacturer’s instructions. The materials must be compatible with process conditions and process fluids. No special installation is required in addition to the standard installation practices outlined in this manual.

The loop must be designed so that the terminal voltage does not drop below the minimum input voltage when the transmitter output is 22.5 mA. See values in [Table 6-1](#).

It is assumed that the personnel installing, configuring, and operating the system have the knowledge equal or greater than that of a qualified instrument technician familiar with safety-related systems, process control applications, and general instrument use.

Table 6-1. Minimum Input Terminal Voltage (U_i) at Different Currents

Hazardous approval	Current			
	3.60 mA	3.75 mA	21.75 mA	22.50 mA
	Minimum input voltage (U_{hi})			
Non-Hazardous installations and intrinsically safe installations	16 Vdc	16 Vdc	11 Vdc	11 Vdc
Explosion-proof/flameproof installations	20 Vdc	20 Vdc	15.5 Vdc	15.5 Vdc

Note

The Rosemount 5300 Series Transmitter is not safety-rated during maintenance work, configuration changes, multidrop, loop test, or other activity that affects the safety function. Alternative means should be used to ensure process safety during such activities.

6.2 Configuring in SIS applications

Use a HART® compliant master, such as Rosemount Radar Master (RRM) or a Field Communicator, to communicate with and verify configuration of the Rosemount 5300 Series. These instructions are applicable to the Rosemount 5300 Series safety-certified options with any differences noted.

Damping

User-adjusted damping will affect the transmitter's ability to respond to process changes. Therefore, the damping values + response time should not exceed the loop requirements.

Alarm and saturation levels

DCS or safety logic solver should be configured to handle both High alarm and Low alarm. It is also required that the transmitter is configured for High or Low alarm. Figure 6-1 identifies the alarm levels available and their operation values⁽¹⁾.

Figure 6-1. Alarm Levels and Operation Values

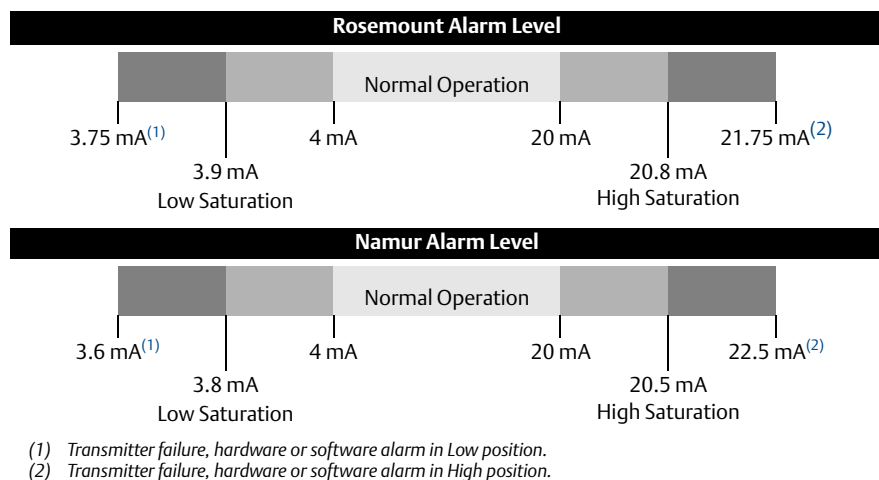

It is assumed that the current output signal is fed to a SIL 2-compliant analog input board of a safety logic solver.

Note

Only the High or Low Alarm Mode can be used for the safety function. Do not choose Freeze Current.

Write protection

A Rosemount 5300 Series safety-certified transmitter should always be protected from unintentional configuration changes by a password protected function.

(1) In certain cases, the transmitter does not go into the user defined alarm state. For example, in case of a short circuit, the transmitter goes into High Alarm state even if Low Alarm has been configured.

Site acceptance

After installation and/or configuration, proper operation of the transmitter (including verification of all configuration changes) must be verified. A site acceptance test is therefore required. The proof test outlined in this document can be used for this.

6.3 SIS operation and maintenance

6.3.1 Proof test

The following proof test is recommended. If an error is found in the safety function, the measuring system must be switched out of service and the process held in a safe state by means of other measures. Proof test results and corrective actions taken must be documented at <http://www.rosemount.com/safety>.

Note

For a valid result, always perform the proof test on the product that will be stored in the tank while the device is in operation.

Note

Before every test, make sure you are connected to the correct transmitter by verifying QT/QS in the model code on the label and your software version. Also verify that the serial number on the label matches the one in your configuration tool. Make sure to enable write protection as soon as you are finished.

Required tools: HART host/communicator and mA meter.

Note that prior to these tests, inspect the echo curve to ensure that no disturbing echoes affecting the measurement performance are present.

RRM:

- Go to **Setup > Echo Curve**.

AMS Device Manager and Field Communicator:

- Go to **Service Tools > Echo tuning > Echo Curve**.

Suggested comprehensive proof test

The suggested proof test described below detects approximately **89%** in of possible Dangerous Undetected (DU) failures in the Rosemount 5300 Series Transmitters.

1. Bypass the safety function and take appropriate action to avoid a false trip.
2. Disable write protection in device (if enabled).

<p><i>RRM:</i></p> <ol style="list-style-type: none"> a. In the Tools menu, select Lock/Unlock Configuration Area. b. Enter Password to unlock. 	<p><i>AMS Device Manager and Field Communicator:</i></p> <ol style="list-style-type: none"> a. Go to Configure > Manual Setup > Device Setup > Security. For HART Device Revision 3: go to Device Diagnostics > Tools > General. b. Select Write Protect and follow the instructions.
--	--
3. Retrieve any diagnostics and take appropriate action.

<p><i>RRM:</i></p> <ul style="list-style-type: none"> ■ Go to Tools > Diagnostics. See the Rosemount 5300 Series Reference Manual (document number 00809-0100-4530, diagnostic messages) for recommended actions. 	<p><i>AMS Device Manager and Field Communicator:</i></p> <ul style="list-style-type: none"> ■ Go to Service Tools > Alerts. See the Rosemount 5300 Series Reference Manual (document number 00809-0100-4530, diagnostic messages) for recommended actions. For HART Device Revision 3: go to Device Diagnostics > Diagnostics.
--	--
4. Using Loop Test, enter current value (mA) representing high alarm current. Verify that analog output current and terminal voltage are correct using reference meters.

This step tests for voltage compliance problems, such as low power supply voltage or increased wiring resistance.

<p><i>RRM:</i></p> <ol style="list-style-type: none"> a. Go to Setup > Output > Analog Out 1 and select Loop test. b. Enter current value representing high alarm current. c. Select Start to output current. d. Verify that analog output current is correct. e. Verify that terminal voltage is correct. See values in Table 6-1. f. Select Stop to end loop test. 	<p><i>AMS Device Manager and Field Communicator:</i></p> <ol style="list-style-type: none"> a. Go to Configure > Manual Setup > Device Setup > Output. For HART Device Revision 3: Go to Configure/Setup > Analog Output > Analog Out. b. Select Loop Test > Other. c. Enter current value representing high alarm current. d. Verify that analog output current is correct. e. Verify that terminal voltage is correct. See values in Table 6-1. f. Select Abort to end loop test.
--	--

5. Using Loop Test, enter current value (mA) representing low alarm current. Verify that analog output current and terminal voltage are correct using reference meters.

This step tests for possible quiescent current related failures.

RRM:

- a. Go to **Setup > Output > Analog Out 1** and select **Loop test**.
- b. Enter current value representing low alarm current.
- c. Select **Start** to output current.
- d. Verify that analog output current is correct.
- e. Verify that terminal voltage is correct. See values in [Table 6-1](#).
- f. Select **Stop** to end loop test.

AMS Device Manager and Field Communicator:

- a. Go to **Configure > Manual Setup > Device Setup > Output**.
For HART Device Revision 3: Go to **Configure/Setup > Analog Output > Analog Out**.
- b. Select **Loop Test > Other**.
- c. Enter current value representing low alarm current.
- d. Verify that analog output current is correct.
- e. Verify that terminal voltage is correct. See values in [Table 6-1](#).
- f. Select **Abort** to end loop test.

6. Enable write protection.

RRM:

- a. In the **Tools** menu, select **Lock/Unlock Configuration Area**.
- b. Enter **Password** to lock.

AMS Device Manager and Field Communicator:

- a. Go to **Configure > Manual Setup > Device Setup > Security**.
For HART Device Revision 3: go to **Device Diagnostics > Tools > General**.
- b. Select **Write Protect** and follow the instructions.

7. Inspect the transmitter for any leaks, visible damage, or contamination.
8. Perform a two-point calibration check of the device by verifying level output for two points on the probe within measuring range. Verify that the current output corresponds to the level input values using a known reference measurement.

This step verifies that the analog output is correct in the operating range and that the Primary Variable is properly configured.

Note

The applied level has to be between upper and lower range values, otherwise the device enters alarm mode. If level is outside maximum measuring range, the level reading accuracy may be reduced. For best performance, use the 4-20 mA range points as calibration points. See [Figure 6-2](#) for range values.

Figure 6-2. Range Values

- A. Upper Blind Zone
- B. Reduced Accuracy
- C. Maximum Measuring Range
- D. Reduced Accuracy
- E. Lower Blind Zone
- F. 20mA
- G. Range 0 -100%
- H. 4mA

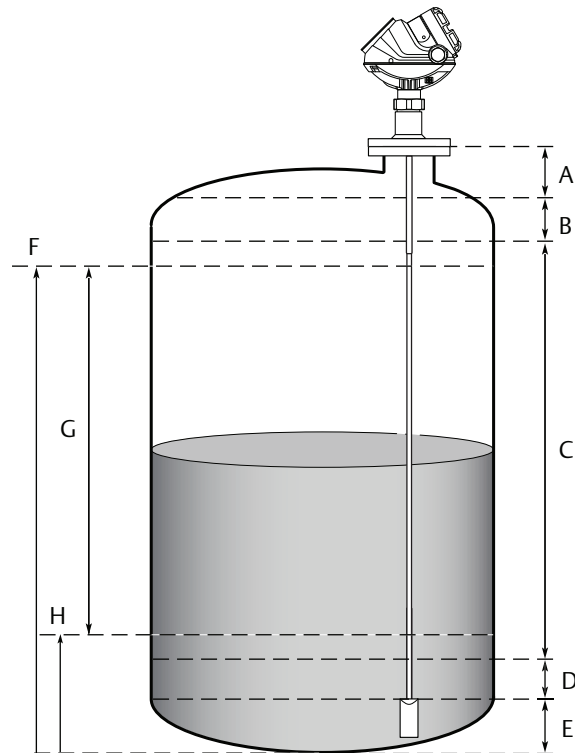

9. Restore the loop to full operation.
10. Remove the bypass from the safety Programmable Logic Controller (PLC) or otherwise restore normal operation.
11. Document “as found” conditions and test results using a tool like SILStat™.

Appendix A Commissioning Checklist

Note

Not all fields in this form are applicable to all transmitters.

A.1 Plant information

Completed Not completed

Plant name:	System No.:	Country:
Issued by:	Issuing agent/ Company name:	Date:

This product data sheet covers both HART® and FOUNDATION™ fieldbus protocols unless specified.

A.1.1 General information

Completed Not completed

Gauge type:	Serial No.:	Tag/tank No:
<input type="checkbox"/> 3300 <input type="checkbox"/> 5300		
Model string:		
		Software version:
Start code:		

A.1.2 Tank information

Completed Not completed

Short application description:	
Tank type:	
<input type="checkbox"/> Vertical cylinder	<input type="checkbox"/> Horizontal cylinder <input type="checkbox"/> Spherical <input type="checkbox"/> Cubical
<input type="checkbox"/> Solid product	<input type="checkbox"/> Turbulent surface
<input type="checkbox"/> Splash loading (filling from top)	<input type="checkbox"/> Steam/heavy vapor
<input type="checkbox"/> Insulated tank walls	<input type="checkbox"/> Condensation on antenna
<input type="checkbox"/> Obstacles below antenna (e.g. baffles, pipes, heating coils)	
<input type="checkbox"/> Emulsion	<input type="checkbox"/> Interface measurement
Operating process temperature and pressure range:	
<input type="radio"/> °C <input type="radio"/> °F	<input type="radio"/> bar <input type="radio"/> psi
Product:	Dielectric constant range:
	<input type="checkbox"/> <1.4-1.9 <input type="checkbox"/> 1.9-2.5 <input type="checkbox"/> 2.5-4 <input type="checkbox"/> 4-10
	<input type="checkbox"/> >11-20 <input type="checkbox"/> >20
Antenna type:	Pipe diameter:
R - tank reference height	G - offset distance
Tank diameter:	Distance from transmitter to tank wall:
Volume:	
<input type="checkbox"/> Strapping table	<input type="checkbox"/> Ideal sphere
<input type="checkbox"/> Ideal horizontal cylinder	<input type="checkbox"/> Ideal vertical cylinder

A.1.3 Mechanical installation

Completed Not completed

Common

Mounting type:	
<input type="checkbox"/> Pipe/chamber	<input type="checkbox"/> Nozzle <input type="checkbox"/> Direct/bracket
Nozzle diameter:	
Nozzle height:	
Nozzle orientation (position on tank, angled, vertical, horizontal, etc.):	
Is the still pipe/chamber (when applicable) smooth on the inside and without intruding welds, burrs, etc.?	<input type="checkbox"/> YES <input type="checkbox"/> NO <input type="checkbox"/> N/A
Proper cable glands in place	<input type="checkbox"/> YES <input type="checkbox"/> NO
Cable glands properly tightened	<input type="checkbox"/> YES <input type="checkbox"/> NO
Are the plastic protective plugs removed from all unused cable entries and metal blanking plugs fitted and tightened?	<input type="checkbox"/> YES <input type="checkbox"/> NO
Transmitter head - antenna/probe connection dry and tightened	<input type="checkbox"/> YES <input type="checkbox"/> NO
Gaskets properly in place	<input type="checkbox"/> YES <input type="checkbox"/> NO <input type="checkbox"/> N/A
Visual inspection of the radar installation	<input type="checkbox"/> YES <input type="checkbox"/> NO
Is the nozzle properly insulated (if applicable e.g. hot product)?	<input type="checkbox"/> YES <input type="checkbox"/> NO <input type="checkbox"/> N/A

Probe clearance to wall/disturbing object(s) OK	<input type="checkbox"/> YES <input type="checkbox"/> NO
Probe end anchored/grounded	<input type="checkbox"/> YES <input type="checkbox"/> NO
Nozzle size within stated limits	<input type="checkbox"/> YES <input type="checkbox"/> NO
If DVC: DVC conditions fulfilled	<input type="checkbox"/> YES <input type="checkbox"/> NO <input type="checkbox"/> N/A

A.1.4 Electrical installation

Completed Not completed

Power supply within limits	<input type="checkbox"/> YES <input type="checkbox"/> NO
Voltage measured at the terminal at the transmitter:	
Groundings according to manual and local regulations	<input type="checkbox"/> YES <input type="checkbox"/> NO
Ground check done with multimeter	<input type="checkbox"/> YES <input type="checkbox"/> NO
Voltage measured between - terminal and ground:	<input type="checkbox"/> YES <input type="checkbox"/> NO
Voltage measured between + terminal and ground:	<input type="checkbox"/> YES <input type="checkbox"/> NO
Resistance measured between transmitter head external ground terminal and tank ground terminal:	<input type="checkbox"/> YES <input type="checkbox"/> NO
Is the cable shield connected according to guidelines in the Reference Manual and local regulations?	<input type="checkbox"/> YES <input type="checkbox"/> NO
Is the transmitter head external ground terminal connected according to guidelines in the Reference Manual and to local regulations?	<input type="checkbox"/> YES <input type="checkbox"/> NO
Type and size of cable used for the communication:	
Is the lid to the terminal compartment properly closed?	<input type="checkbox"/> YES <input type="checkbox"/> NO
Is the product's Ex classification in accordance with requirements?	<input type="checkbox"/> YES <input type="checkbox"/> NO

A.1.5 Is the product's Ex classification in accordance with requirements?

YES NO

For more information see Section: "Complete the basic configuration" on page 3 and Section "Echo curve verification at operating conditions" on page 24.

Primary Output:	
<input type="checkbox"/> 4-20 mA HART®	<input type="checkbox"/> FOUNDATION fieldbus™
<input type="checkbox"/> Modbus® SW version (33, 53, 5400):	
Bus address (if used):	
Source:	Alarm action (current):
	<input type="checkbox"/> High <input type="checkbox"/> Freeze <input type="checkbox"/> Low
	<input type="checkbox"/> Namur
Lower range (4 mA):	Upper range (20 mA):

A.2 Echo tuning

Completed Not completed

For more information see Section: “Complete the advanced configuration” on page 7 and “Review echo curve” on page 10l.

Configuration tool used:	
<input type="checkbox"/> RRM/RCT <input type="checkbox"/> 475 <input type="checkbox"/> DD (AMS) <input type="checkbox"/> DTM - specify host:	
Software version:	
Firmware version:	
Thresholds set at an appropriate level	<input type="checkbox"/> YES <input type="checkbox"/> NO
Possible false echoes properly registered (non-contacting only)	<input type="checkbox"/> YES <input type="checkbox"/> NO
Trim Near Zone done (guided wave radar only)	<input type="checkbox"/> YES <input type="checkbox"/> NO
Probe End Projection properly activated (guided wave radar only)	<input type="checkbox"/> YES <input type="checkbox"/> NO <input type="checkbox"/> N/A
UNZ configured	<input type="checkbox"/> YES <input type="checkbox"/> NO <input type="checkbox"/> N/A
Echo amplitude and Signal-to-Noise Ratio OK	<input type="checkbox"/> YES <input type="checkbox"/> NO
Transmitter measurement and data in the expected range	<input type="checkbox"/> YES <input type="checkbox"/> NO

A.3 Backups and plots

Completed Not completed

For more information see section: “Archive files” on page 14.

Initial backup taken and enclosed	<input type="checkbox"/> YES <input type="checkbox"/> NO
Final backup taken and enclosed	<input type="checkbox"/> YES <input type="checkbox"/> NO
Initial plots taken and enclosed	<input type="checkbox"/> YES <input type="checkbox"/> NO
Final plots taken and enclosed	<input type="checkbox"/> YES <input type="checkbox"/> NO
Trends from DCS taken and enclosed	<input type="checkbox"/> YES <input type="checkbox"/> NO <input type="checkbox"/> N/A

A.4 GWR radar verification in chambers

UNIT:		<p>Note: Verification procedure is performed under ambient conditions. For dynamic vapor compensations units, ensure that the DC is calculated at 1.0 before starting verification process. If static vapor compensation is used, set vapor DC to 1 for the test and reset to desired value when finished. For all other units, vapor DC should be set at 1.</p> 		
DATE:				
TIME:				
TECH:				
STEP	TASK	DEVICE TAG:	DEVICE TAG:	DEVICE TAG:
		SERIAL NUMBER:	SERIAL NUMBER:	SERIAL NUMBER:
1	Isolate chamber using upper and lower block valves	<input type="checkbox"/> YES <input type="checkbox"/> NO	<input type="checkbox"/> YES <input type="checkbox"/> NO	<input type="checkbox"/> YES <input type="checkbox"/> NO
2	Vent chamber using upper vent valves	<input type="checkbox"/> YES <input type="checkbox"/> NO	<input type="checkbox"/> YES <input type="checkbox"/> NO	<input type="checkbox"/> YES <input type="checkbox"/> NO
3	Open bottom vent valves and connect water source	<input type="checkbox"/> YES <input type="checkbox"/> NO	<input type="checkbox"/> YES <input type="checkbox"/> NO	<input type="checkbox"/> YES <input type="checkbox"/> NO
4	Open up echo curve and start continuous record mode	** Leave in continuous record mode throughout test **	** Leave in continuous record mode throughout test **	** Leave in continuous record mode throughout test **
5	Verification at zero (LRV - 4mA)	Radar Output (Level):	Radar Output (Level):	Radar Output (Level):
		Radar Output (mA):	Radar Output (mA):	Radar Output (mA):
		DCS Reading:	DCS Reading:	DCS Reading:
6	Verification at nominal level condition	Radar Output (Level):	Radar Output (Level):	Radar Output (Level):
		Radar Output (mA):	Radar Output (mA):	Radar Output (mA):
		DCS Reading:	DCS Reading:	DCS Reading:
7	DCS (zero check - bias added)	DCS Reading - (w/ Bias):	DCS Reading - (w/ Bias):	DCS Reading - (w/ Bias):
8	Trim gauges to read identical levels (if needed)	Enter "Calibration Offset" values in gauges as required to bring them all to identical level readings	Enter "Calibration Offset" values in gauges as required to bring them all to identical level readings	Enter "Calibration Offset" values in gauges as required to bring them all to identical level readings
9	View echo curve and make threshold adjustments	** Adjust only if needed **	** Adjust only if needed **	** Adjust only if needed **

10	Verification at filled condition (URV -20mA)	Radar Output (Level): _____ Radar Output (mA): _____ DCS Reading: _____	Radar Output (Level): _____ Radar Output (mA): _____ DCS Reading: _____	Radar Output (Level): _____ Radar Output (mA): _____ DCS Reading: _____
11	Completely fill chamber with water to verify "Bad Quality" reading on DCS	<input type="checkbox"/> YES <input type="checkbox"/> NO	<input type="checkbox"/> YES <input type="checkbox"/> NO	<input type="checkbox"/> YES <input type="checkbox"/> NO
12	Completely drain chamber of water	<input type="checkbox"/> YES <input type="checkbox"/> NO	<input type="checkbox"/> YES <input type="checkbox"/> NO	<input type="checkbox"/> YES <input type="checkbox"/> NO
13	Stop and save echo plots	<input type="checkbox"/> YES <input type="checkbox"/> NO	<input type="checkbox"/> YES <input type="checkbox"/> NO	<input type="checkbox"/> YES <input type="checkbox"/> NO
14	Save "As Left" configuration files	<input type="checkbox"/> YES <input type="checkbox"/> NO	<input type="checkbox"/> YES <input type="checkbox"/> NO	<input type="checkbox"/> YES <input type="checkbox"/> NO
15	Put all valves back to "As Found" position	<input type="checkbox"/> YES <input type="checkbox"/> NO	<input type="checkbox"/> YES <input type="checkbox"/> NO	<input type="checkbox"/> YES <input type="checkbox"/> NO
For this procedure, a see-thru flexible tubing with a Y connection can be attached to the drain line of the chamber. With this, water can be pumped into the chamber thru one side of the Y. The other side of the Y should extend along the side of the chamber to the top. The water level will be visible in this line.				

In need of support with a transmitter, send a commissioning report together with a backup file from the transmitter to your local Emerson Process Management representative.

Rosemount World Headquarters

Emerson Process Management

6021 Innovation Blvd

Shakopee, MN 55379, USA

+1 800 999 9307 or +1 952 906 8888

+1 952 949 7001

RFQ.RMD-RCC@EmersonProcess.com

North America Regional Office

Emerson Process Management

8200 Market Blvd.

Chanhassen, MN 55317, USA

+1 800 999 9307 or +1 952 906 8888

+1 952 949 7001

RMT-NA.RCCRFQ@Emerson.com

Latin America Regional Office

Emerson Process Management

1300 Concord Terrace, Suite 400

Sunrise, Florida, 33323, USA

+1 954 846 5030

+1 954 846 5121

RFQ.RMD-RCC@EmersonProcess.com

Europe Regional Office

Emerson Process Management Europe GmbH

Neuhofstrasse 19a P.O. Box 1046

CH 6340 Baar

Switzerland

+41 (0) 41 768 6111

+41 (0) 41 768 6300

RFQ.RMD-RCC@EmersonProcess.com

Asia Pacific Regional Office

Emerson Process Management Asia Pacific Pte Ltd

1 Pandan Crescent

Singapore 128461

+65 6777 8211

+65 6777 0947

Enquiries@AP.EmersonProcess.com

Middle East and Africa Regional Office

Emerson Process Management

Emerson FZE P.O. Box 17033,

Jebel Ali Free Zone - South 2

Dubai, United Arab Emirates

+971 4 8118100

+971 4 8865465

RFQ.RMTMEA@Emerson.com

Standard Terms and Conditions of Sale can be found at:
www.rosemount.com/terms_of_sale.

The Emerson logo is a trademark and service mark of Emerson Electric Co.

Rosemount and Rosemount logotype are registered trademarks of Rosemount Inc.

HART is a registered trademark of the FieldComm Group.

FOUNDATION fieldbus is a trademark of the FieldComm Group.

AMS is a registered trademark of Emerson Electrical Co.

DeltaV is a trademark of one of the Emerson Process Management group of companies.

Modbus is a registered trademark of Modicon Inc.

All other marks are the property of their respective owners.

© 2015 Rosemount Inc. All rights reserved.