Operator's Manual

Model 4100 and 4200 Series Liquid-to-Liquid Coolers



Table of Contents

Introduction	3
General Safety Information	3
Safety Recommendations	4
Unpacking Your Liquid-to-Liquid Cooler	4
Regulatory and Compliance Testing	4
Contents	4
Controls and Components	5
Front Control Panel	5
Rear Panel	5
Installation and Startup	6
Site Requirements	6
Ambient Temperature and Relative Humidity	6
Location	6
Clearance	6
External Piping	6
General Considerations	6
Process Fluid Connections	7
Facility Water Connections	7
Process Coolant	7
Electrical Power	8
Main Power Connection	8
Optional Serial Output (RS-232)	8
Optional Dry Contact Remote ON/OFF	8
Startup	9
Normal Operation	10
Electrical Power	10
Selecting the Temperature Unit	10
Displaying and Adjusting the Set Point	10
Setting Operational Parameters	11
High Temperature Limit (HL)	11
Low Temperature Limit (LL)	11
High Ambient Temperature Limit (HA)	12
Maximum Fluid Pressure (FP)	12
Minimum Flow Rate (FL)	12
Calibration Offset (°C)	13
Flow Calibration (Fc)	13
Baud Rate (PC)	14
Adjusting the High Pressure Bypass Setting	14
Display, Alarm and Error Messages	15
Enabling / Disabling the Local Lockout	17
Routine Maintenance and Troubleshooting	18
Routine Maintenance	18
Air Vents	18
Process and Facility Line Strainers	18
In-Line Fluid Filter	18
Fluid Level	18
Software Version	18
Draining the Unit	19
Troubleshooting Chart	19
Technical Information	20
Performance Specifications	20
Cooling Capacity vs. Facility Water Flow Rate	21
Wiring and Flow Diagram	22

Reservoir Fluids	23
Replacement Parts	24
PolyScience Fluids	24
Optional Serial Output (RS-232).....	25
Equipment Disposal (WEEE Directive).....	26
Service and Technical Support	26
Warranty	27

Introduction

Your Liquid-to-Liquid Cooler is a quiet and efficient heat removal system. Process cooling is provided by pumping facility water (or other liquid cooling medium) through a liquid-to-liquid brazed plate heat exchanger to cool the process fluid loop. Heat is rejected to the facility fluid and temperature controlled by a proportional valve that bypasses a portion of the process fluid around the heat exchanger. Because the facility water and process fluid remain separate, there is no risk of equipment damage due to facility water contamination.







Key features:

- Powerful liquid-to-liquid cooling
- Quiet, energy-efficient operation
- Microprocessor control
- Digital set and read (°C or °F)

It will take you very little time to get your Liquid-to-Liquid Cooler installed and running. This manual is designed to guide you quickly through the process. We recommend that you read it thoroughly before you begin.

General Safety Information

When installed, operated, and maintained according to the directions in this manual and common safety procedures, your Liquid-to-Liquid Cooler should provide safe and reliable heat removal. Please ensure that all individuals involved in the installation, operation, or maintenance of this unit read this manual thoroughly prior to working with the unit.

	This symbol alerts you to wide range of potential dangers. When attached to the unit, this symbol draws attention to the relevant section of the operator's manual.
	This symbol advises you of danger from electricity or electric shock.
	This symbol marks information that is particularly important.
	This symbol indicates alternating current.
	These symbols on the Power Switch / Circuit Breaker indicate that they place the main power supply ON / OFF.
	This symbol on the Power Switch indicates that it places the unit in a standby mode. It DOES NOT fully disconnect the unit from the power supply.
	This symbol indicates a protective conductor terminal.

**Read all instructions pertaining to safety, set-up, and operation.
Proper operation and maintenance is the user's responsibility.**

Safety Recommendations

To prevent injury to personnel and/or damage to property, always follow your workplace's safety procedures when operating this equipment. You should also comply with the following safety recommendations:

	<p>WARNING:</p> <ul style="list-style-type: none">• Always connect the power cord on this unit to a grounded (3-prong) power outlet. Make certain that the outlet is the same voltage and frequency as your unit.• Never operate the unit with a damaged power cord.• Always turn the unit OFF and disconnect Mains power before performing any maintenance or service.
---	--

	<p>CAUTION: To ensure that internal damage does not occur during shipping or storage, water must be drained from all parts of the system or an antifreeze solution added.</p>
---	--

Unpacking Your Liquid-to-Liquid Cooler

Your Liquid-to-Liquid Cooler is shipped in a special carton. Retain the carton and all packing materials until the unit is completely assembled and working properly. Set up and run the unit immediately to confirm proper operation. Beyond one week, your unit may be warranty repaired, but not replaced. If the unit is damaged or does not operate properly, contact the transportation company, file a damage claim and contact the company where your unit was purchased immediately.

	<p>CAUTION: Keep unit upright when moving. Be sure to follow your company's procedures and practices regarding the safe lifting and relocation of heavy objects.</p>
---	---

Regulatory and Compliance Testing

Canada USA (60Hz units)

CAN/CSA C22.2 No. 61010-1-12 — Safety Requirements for Electrical Equipment for Measurement, Control and Laboratory Use, Part I: General Requirements.

UL Std No. 61010-1 (2012) — Safety Requirements for Electrical Equipment for Measurement, Control and Laboratory Use - Part I: General Requirements.

CE (50Hz units)

Machinery Directive 2006/42/EC

EC Electromagnetic Compatibility Directive 2014/30/EU

IEC 61010-1 / EN 61010-1:2010

IEC 61326:2012 / EN 61326:2013

RoHS Directive 2011/65/EU

Highly Accelerated Life Test (HALT) and Vibration Tests per ASTM D4169-8 (All units)

Contents

The following items have been included with your Liquid-to-Liquid Cooler:

- Liquid-to-Liquid Cooler
- Operator's Manual
- IEC Power Cord

Controls and Components

Front Control Panel

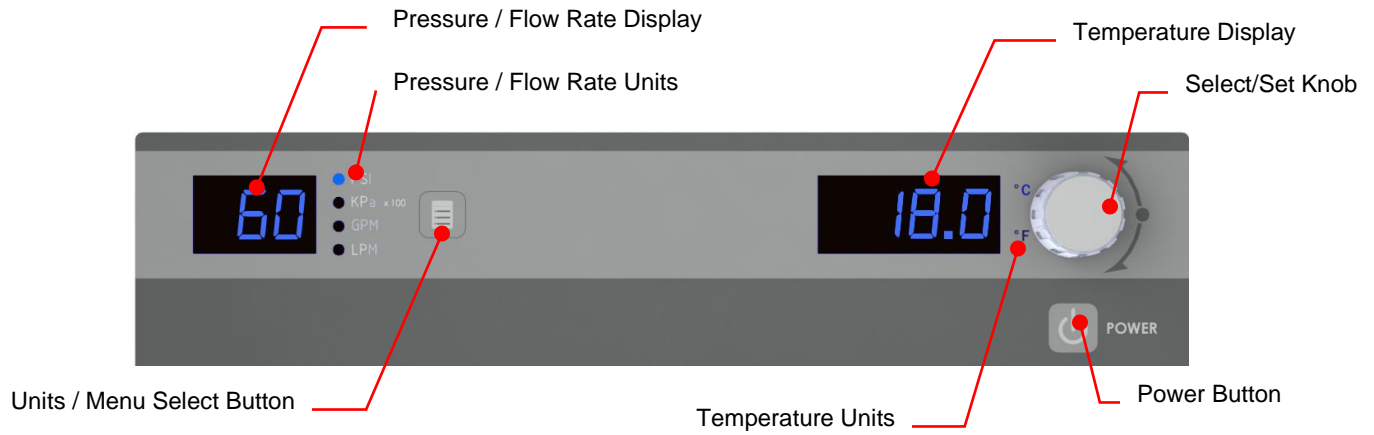

Rear Panel

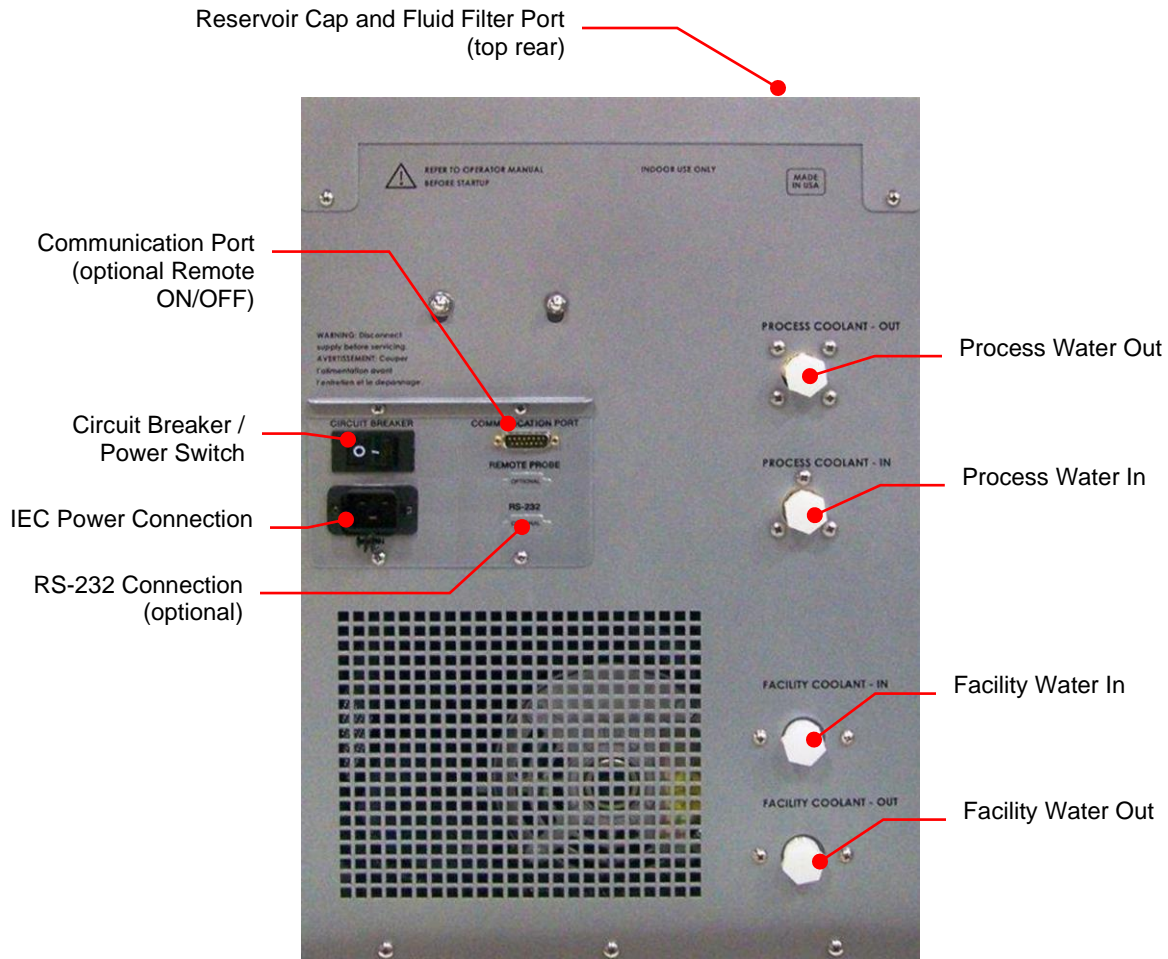

Installation and Startup



WARNING: Be sure all power is off before proceeding.

Site Requirements

Ambient Temperature and Relative Humidity

The Liquid-to-Liquid Cooler is designed for indoor installation in ambient temperatures between 5° and 35°C (41° and 95°F); relative humidity should not exceed 80% (non-condensing).

Location

The Liquid-to-Liquid Cooler should be installed on a strong, level surface. Do not place it where corrosive fumes, excessive moisture, excessive dust, or high room temperatures are present.

For ease of positioning and maneuverability, the unit is supplied with casters. The front wheels can be locked to keep it in place while in use.

To help prevent voltage drops, position the Liquid-to-Liquid Cooler as close as possible to the power distribution panel. Avoid voltage drops by using a properly grounded power outlet wired with 14 gauge or larger diameter wire. The use of an extension cord is not recommended.



NOTE: The Liquid-to-Liquid Cooler may be located at a level below that of the equipment being cooled. As long as the process remains closed, overflow will not occur when adding cooling fluid to the Liquid-to-Liquid Cooler reservoir.

Clearance

Adequate clearance should be allowed on the front, sides, and rear of the Liquid-to-Liquid Cooler for access to the reservoir tank, electrical cabinet, and external piping connections.

External Piping



WARNING: All facility water connections must be made by a licensed plumber.

General Considerations

- Take care when selecting hoses and connections for the Liquid-to-Liquid Cooler. All external piping, tubing, or hoses should be run full size to limit the potential for external pressure drops. Quick-connect fittings may be used, but they can cause substantial pressure drops.
- Materials of construction should be compatible with the fluid being used as well as the temperature and pressure at which the unit will operate.
- Where applicable, always use a back-up wrench when making piping connections to the Liquid-to-Liquid Cooler.
- Pressure Ratings – Hoses should be able to withstand the greatest pressure they will encounter. 150 psi (344.7 kPa) is recommended. Unit will alarm if default value of 80 psi (551.6 kPa) is exceeded; maximum setting is 100 psi (689.5 kPa).
- Flexible Tubing – Avoid tubing that will expand and increase fluid volume when operating at the desired pressure.
- Hose Diameter – The fittings on the Liquid-to-Liquid Cooler's process and facility water fluid inlets and outlets are female 0.5 inch NPT.
- Facility Water – Should be clean and well maintained. Ideally, the facility water should be tested monthly to ensure a pH level between 7.2 and 7.8. Add algacide if algae growth is present.

Process Fluid Connections

Connect the process fluid inlet on the equipment to be cooled to the process fluid outlet on the Liquid-to-Liquid Cooler. Connect the process fluid outlet on the equipment to be cooled to the process fluid inlet on the Liquid Temperature.

Facility Water Connections



WARNING: The incoming cooling water pressure should be limited to 125 psi (861.8 kPa) maximum.

The cooling water supply may be from a chiller, city tap water, or a cooling tower. The cooling water supply should be connected to the facility water inlet on the Liquid-to-Liquid Cooler. The facility water outlet on the Liquid-to-Liquid Cooler should be connected to the appropriate return or drain, as required. The incoming water pressure should be limited to 125 psi (861.8 kPa).



NOTE: A solenoid valve inside the Liquid-to-Liquid Cooler shuts off facility water fluid flow whenever the unit is turned OFF or if an alarm condition is detected that turns the pump OFF.

Process Coolant

See *Technical Information, Reservoir Fluids* (page 23) for additional information.

Suitable Fluids



WARNING: Only use fluids that satisfy safety, health, and equipment compatibility requirements. Caustic, corrosive, or flammable fluids should never be used. Read the safety data sheet for the process fluid being used carefully before filling reservoir.



WARNING: Operation below 15°C (59°F) requires antifreeze in the circulation fluid. DO NOT use automotive antifreeze as the additives may be harmful to the Liquid-to-Liquid Cooler's wetted parts (brass, bronze, stainless steel, EPDM rubber, nylon, and PVC).

The Liquid-to-Liquid Cooler is designed to accommodate a variety of coolant fluids (water, glycol mixtures, etc). For most applications above 15°C (59°F), distilled water is satisfactory. For operation at or below 15°C (59°F), the unit must be protected with an antifreeze solution. Ethylene glycol (laboratory grade) and distilled water in a 50/50 mixture is satisfactory from +15° to -15°C (59° to 5°F). Select a fluid that is compatible with the Liquid-to-Liquid Cooler's wetted parts (brass, bronze, stainless steel, EPDM rubber, nylon, and PVC).

Electrical Power



WARNING: Be sure that the electrical power supply is the same voltage and frequency as specified on the identification label.



WARNING: DO NOT plug the Liquid-to-Liquid Cooler into the electrical outlet until the unit is ready for startup (see *Startup*).



WARNING: All electrical connections should be made by a qualified, licensed electrician. Proper building codes and safety regulations should be followed.



WARNING: Follow all applicable electrical and safety codes when connecting power to this equipment.



WARNING: Make sure the equipment's main power switch is in the OFF position before connecting or disconnecting electrical power.



CAUTION: DO NOT turn Controller power ON until the Liquid-to-Liquid Cooler's reservoir has been filled. When Controller power is turned ON, the pump automatically begins pumping. If the reservoir has not been filled, the pump could be damaged.

Main Power Connection

Verify that the Power Switch / Circuit Breaker on the rear of the unit is in the OFF position. Attach the IEC power cord provided with the Liquid-to-Liquid Cooler to the receptacle on the rear of the enclosure. Make sure that the power outlet used for the Liquid-to-Liquid Cooler is properly grounded and matches the voltage and frequency indicated on the identification label on the back of the Liquid-to-Liquid Cooler.

The use of an extension cord is not recommended. However, if one is necessary, it must be properly grounded and capable of handling the total wattage of the unit. The extension cord must not cause more than a 10% drop in voltage to the Liquid-to-Liquid Cooler.

Optional Serial Output (RS-232)

This option allows you to remotely control the Liquid-to-Liquid Cooler and/or output temperature readings to an external recorder or other auxiliary device. The maximum communications distance for units equipped with the RS-232 option is 50 feet (15 meters). A 9-pin D-connector is provided on the rear of the instrument enclosure for this connection.

Optional Dry Contact Remote ON/OFF

If the unit is equipped with this option, a 15-pin sub D-connector will be provided on the rear panel. Connect pins 1 and 2 to turn the unit OFF, open to turn the unit ON. When unit has been turned OFF by remote control, EC appears on the right hand display.

Startup

1. Process Fluid

- Connect the Liquid-to-Liquid Cooler to the process to be cooled with hoses or pipes.
- Check hoses and fittings for tightness and make sure there are no crimps or bends in the hoses.

2. Facility Water Fluid

- Connect the Liquid-to-Liquid Cooler to the facility water supply.
- Open the valves to the facility water supply and return.
- Check hoses and fittings for leaks and make sure there are not bends or crimps in the hoses.

3. Filling the Reservoir

- Remove the filler cap from the reservoir and, using a funnel, add fluid until the reservoir is about two-thirds full.
- Once the reservoir is two-thirds full, remove the funnel but do not replace the cap at this time.

4. Electrical Power

- Plug the Liquid-to-Liquid Cooler's power cord into an appropriate electrical outlet.
- Place the Circuit Breaker/Power Switch on the rear of the instrument enclosure in the "ON" position. Three decimal points will appear on the Temperature display; two decimal points will appear on the pressure/flow rate display. This signifies that the Controller is in "Standby" and ready for power up.



5. Starting Process Fluid Flow

- Press the Power Button on the front panel. The pump will turn on and fluid will begin circulating through the system. The set point temperature will appear briefly on the Temperature display; after a few seconds, it will be replaced by the actual fluid temperature.
- Check for leaks.
- With the pump running, the reservoir's fluid level will drop as the process and/or process cooling lines fill with fluid. Slowly add fluid to the reservoir until the liquid level remains stable at about two-thirds full. This means that the system is filled and the air has been purged from it.
- Replace the reservoir cap and turn it clockwise to lock.

Normal Operation

Electrical Power

Place the Circuit Breaker/Power Switch on the rear of the instrument enclosure in the “ON” position. Three decimal points will appear on the Temperature display; two decimal points will appear on the Pressure/Flow Rate display.



Press the Power Button on the Controller’s front panel. 888 will appear on the Temperature display; 88 will appear on the Pressure/Flow Rate display. The pump will turn on and fluid will begin circulating through the system. The set point temperature will appear briefly on the temperature display; after a few seconds, it will be replaced by the actual fluid temperature.

Selecting the Temperature Unit (°C or °F)

The LEDs adjacent to the Temperature Display indicate the unit (°C or °F) used for temperature displays. To change from °C to °F or vice versa, proceed as follows:

To change to °F — Place the Circuit Breaker/Power Switch on the rear of the instrument in the “OFF” position. Press and hold the Units/Menu Select Button while returning the Circuit Breaker/Power Switch to the “ON” position.

To change to °C — Place the Circuit Breaker/Power Switch on the rear of the instrument in the “OFF” position. Press and hold the Power Button on the front panel while returning the Circuit Breaker/Power Switch to the “ON” position.



CAUTION: All user settings, except baud rate and calibration offset, return to the original factory defaults when the temperature unit is changed. The Liquid-to-Liquid Cooler’s temperature set point and various alarm settings should be reset to the desired values.

Displaying and Adjusting the Set Point

Press the Select/Set Knob on the front panel. The current set point temperature will be displayed and the decimal point at the bottom right of the display will flash, indicating that the temperature can be changed.

Rotate the Select/Set Knob until the desired set point temperature is displayed. The setting is accepted after the Select/Set Knob is pressed a second time or automatically after a few seconds of inactivity.

Allow sufficient time for the unit to stabilize at the desired temperature.

Setting Operational Parameters

The Liquid-to-Liquid Cooler's operational parameters can be accessed by pressing and holding the Units/Menu Button until HL appears on the pressure/flow rate display. Pressing and releasing the Units/Menu Button once HL appears allows you to scroll through the various parameters.

The displayed parameter is changed by rotating the Select/Set Knob until the desired value is displayed. You can accept the displayed value by either pressing the Select/Set Knob or allowing the display to timeout.

Menu Item	Description	Choice/Ranges / Comments	Default Setting
HL	High Temperature Limit Alarm Set Point	+21° to 60°C / 69° to 140°F	35°C 95°F
LL	Low Temperature Limit Alarm Set Point	+3° to 20°C / 37° to 68°F	10°C 50°F
HA	Front Panel High Ambient Temperature Alarm Set Point	+30° to 50°C. Always displayed and set in °C.	40°C
FP w/psi LED lit	Maximum Fluid Pressure Alarm Set Point	40 to 100 PSI	80 PSI
FP w/kPa LED lit	Maximum Fluid Pressure Alarm Set Point	2.7 to 6.8 (x 100) kPa	5.5 kPa (x 100)
GPM LED lit	Minimum Flow Rate Alarm Set Point	0 or 2.0 to 8.0 GPM	2.0 GPM
LPM LED lit	Minimum Flow Rate Alarm Set Point	0 or 7.0 to 30.0 LPM	7.0 LPM
AP	Ambient Probe (not available on this model)		nAP
°C	Calibration Offset	±2.9°C (always displayed in °C). Special access procedure required; see <i>Calibration Offset (°C)</i> .	0.0°C
Fc	Flow Calibration	0.01 to 50.0 (gain setting)	Nominal Flow
PC	RS-232 Baud Rate	0, 24, 48, 96, 192. Represents baud rates of 0 (no communication), 2400, 4800, 9600, and 19200.	9600



High Temperature Limit (HL)

This menu item serves two functions. First, it establishes the maximum allowable set point temperature and thus helps prevent an operator from inadvertently selecting a temperature set point above a pre-established value. Secondly, it serves as a high temperature alarm, automatically activating both audio and visual alarm indicators if the measured fluid temperature reaches the HL setting.

HL		35.	
----	---	-----	---

Low Temperature Limit (LL)

This menu item also serves a dual function. First, it establishes the minimum allowable set point temperature and thus helps prevent an operator from inadvertently selecting a temperature set point below a pre-established value. Secondly, it serves as a low temperature alarm, automatically activating both audio and visual alarm indicators if the measured fluid temperature drops to the LL setting.

LL		10.	
----	---	-----	---

High Ambient Temperature Limit (HA)



NOTE: This value is always set in °C.

This menu item protects the unit from overheating due to a high ambient temperature. Should the ambient temperature rise above the limit value, the audio and visual alarms will activate and the pump will turn OFF.

To change the high ambient temperature value, rotate the Select/Set Knob until the desired value is displayed on the temperature readout.

HA		40.	
----	--	-----	--

Maximum Fluid Pressure (FP)

This is the maximum allowable fluid pressure and can be set in either PSI or kPa (the LED adjacent to the display indicates the active unit of measure). Should the fluid pressure rise above the maximum fluid pressure value, the audio and visual alarms will activate and the pump will turn OFF.

To change the fluid pressure limit value, rotate the Select/Set Knob until the desired value is displayed on the temperature readout.



NOTE: When FP first appears, the PSI LED will be lit. To view the FP value in kPa, press the Units/Menu Button again. The FP will remain on the display, and the kPa LED will light up.

FP	• PSI		80	
----	-------	--	----	--

FP	• kPa x 100		5.5	
----	-------------	--	-----	--

Minimum Flow Rate (FL)

This is the minimum allowable flow rate and can be set in either GPM or LPM (the LED adjacent to the display indicates the active unit of measure). Should the fluid flow rate drop below the minimum value, the audio and visual alarms will activate and the pump will turn OFF.

To change the minimum flow rate value, rotate the Select/Set Knob until the desired flow rate value is displayed on the temperature readout.

With FL set to "0", the flow alarm is disabled, and the unit will continue to operate with the output flow blocked.



NOTE: When FL first appears, the GPM LED will be lit, indicating the FL value is GPM. To view the FL value in LPM, press the Units/Menu Button again. The FL will remain on the display and the LPM LED will light up.

FL	• Option E		2.0	
----	------------	--	-----	--

FL	• Option M		7.0	
----	------------	--	-----	--

Calibration Offset (°C)



CAUTION: To prevent the operator from accidentally changing the calibration offset, a special keystroke sequence is required to access this function.

This menu item allows you to adjust the Liquid-to-Liquid Cooler's temperature reading to match that of a traceable standard. It allows you to offset the displayed temperature value by as much as $\pm 2.9^{\circ}\text{C}$.



NOTE: Calibration offset values are always set and displayed in $^{\circ}\text{C}$.

1. Press and hold the Units/Menu Button until HL appears on the display.
2. Press and release the Units/Menu Button until AP appears on the display.
3. Press and hold the Units/Menu Button.
4. While holding the Units/Menu Button, press and release the Select/Set Knob.
5. When CAL appears on the temperature readout, release the Units/Menu Button. The current calibration offset value will appear on the temperature readout and alternate with the fluid temperature reading (enabling you to simultaneously adjust the offset and see the effect on the temperature).
6. Rotate the Select/Set Knob until the desired calibration offset is displayed. Press the Select/Set Knob or simply allow the display to time out to accept the displayed value.

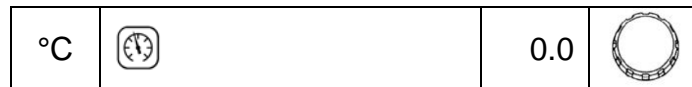

Flow Calibration (Fc)

This menu item allows you to calibrate (single point) the flow rate in GPM. Flow rate is calibrated at the factory at the nominal flow rate for this unit; further adjustment should not be necessary. However, if you wish to calibrate the unit's flow rate against a known standard, the calibration is performed as follows:

1. Press and hold the Units/Menu Button until HL appears on the display.
2. Press and release the Units/Menu Button until $^{\circ}\text{C}$ appears on the display.
3. Press and hold the Units/Menu Button; Fc will appear on the display.
4. While holding the Units/Menu Button, press and release the Select/Set Knob.
5. Release the Units/Menu Button and rotate the Select/Set Knob to change the flow reading on the left hand display (GPM); the reading on the right hand display is the gain value and is for factory reference only.
6. When the flow rate is calibrated, press the Select/Set Knob to return to normal operation.



Baud Rate (PC)

This menu item allows you to establish the baud rate for serial communication. Allowable settings are 0 (no serial communication), 24 (2400 baud), 48 (4800 baud), 96 (9600 baud), 192 (19200 baud).

To change the displayed setting, rotate the Select/Set Knob until the desired baud rate is displayed.

Press the Select/Set Knob or allow the display to time out to accept the displayed value.



Adjusting the High Pressure Bypass Setting

4100 and 4200 Series Liquid-to-Liquid Coolers with positive displacement or turbine pumps incorporate an automatic safety to maintain outlet pressure below a valve-regulated pressure. This valve is adjustable and is located inside the unit's housing.



WARNING: There are exposed fan blades inside the housing. Exercise extreme care when accessing or adjusting any interior components.



WARNING: Hazardous voltages are present.

To access the high-pressure bypass valve, remove the two screws at the upper left and right corners of the Cooler's rear panel, slide the top panel back about 2-3 inches, and lift off. The regulator valve is located in the left rear corner of the unit.

The high-pressure bypass is adjusted as follows:

1. Set the low flow rate alarm value to zero (see *Setting Operational Parameters, Minimum Flow Rate*, page 12). This will prevent the unit from activating the flow alarm while you are adjusting the maximum pressure setting.
2. Completely block the Cooler's outlet flow. This should cause the outlet pressure to rise.
3. Set the Pressure/Flow Rate display to read either PSI or kPa.
4. Rotate the handle on the pressure valve until the desired maximum pressure setting is shown on the Pressure/Flow Rate display.
5. Reset the flow alarm value to the previous setting.
6. Return the Pressure/Flow Rate display to the previous setting.
7. Replace the top panel of the Cooler, being sure to secure the bayonet-style prongs on the front of the panel in the openings at the front of the unit. Reinsert the two screws that secure the top panel to the rear panel of the unit.

Display, Alarm and Error Messages

When certain conditions are detected, a message code flashes on the display and the local audio alarm sounds. Depending on the nature of the condition, power to various system components, such as the heater and pump, is removed. When the condition is rectified, push the front panel power button or turn the circuit breaker OFF and then back ON to clear the fault or error.

During an alarm condition, the Pressure/Flow Rate display will alternate between “°C” and “Ft”. The Temperature Display will alternate between the current process temperature and a fault code (see below).

Message Code	Description	Action Required
EFL	Insufficient or no flow through heat exchanger	Warning / Alarm — Insufficient flow to heat exchanger. An alarm will sound once every 8 seconds for 5 occurrences. If the flow is still low after 40 seconds, the unit will shut down. Increase flow.
EHA	Front panel high ambient temperature warning	Warning - The ambient temperature is higher than the set ambient limit. Lower ambient temperature or raise temperature limit.
EHL	High temperature set point warning	Warning — The temperature set point is higher than the high temperature limit value. If not corrected, the high temperature limit alarm will be activated when the fluid temperature rises above the established HL value. Lower temperature set point or increase high temperature limit value.
ELL	Low temperature set point warning	Warning — The temperature set point is lower than the low temperature limit value. If not corrected, the low temperature limit alarm will be activated when the fluid temperature falls below the established LL value. Increase temperature set point or decrease low temperature limit value.
LLO	Local Lockout	Normal — Indicates that the Local Lockout feature is enabled. Appears momentarily when Select/Set Knob is pressed to view/change set point value. See <i>Enabling/Disabling the Local Lockout</i> (page 17).
CAn	Cancel Local Lockout	Normal — Indicates that the Local Lockout feature has been disabled. Appears momentarily when the Local Lockout status is changed from enabled (LLO) to disabled.

Fault Code	Description	Action Required
02	Low temperature alarm (signaled if <16°C / 60.8°F for 5 seconds)	Alarm — Process fluid temperature has dropped to low temperature limit value. Pump is turned OFF. Increase heat load or decrease low temperature limit value.
03	High limit temperature alarm	Alarm — Process fluid temperature has reached the high temperature limit value. Pump is turned OFF. Decrease heat load or increase high temperature limit value.
05	Low liquid level alarm (optional)	Delayed Alarm — Activated when the liquid level in the reservoir falls below an acceptable level for 30 seconds or longer. Pump is turned OFF. Add fluid to reservoir.
06	High bath temperature alarm	Alarm — Fluid temperature has exceeded 82°C (180°F). Pump is turned OFF. Lower fluid temperature.
07	Low flow alarm	Alarm — Flow rate has dropped below minimum flow rate setting. Pump is turned OFF. Note: Disabled during first 2 minutes of operation. Correct cause of low flow rate or decrease minimum flow rate setting.
08	High pressure alarm	Delayed Alarm — Fluid outlet pressure has exceeded high-pressure limit value for 30 seconds. Pump is turned OFF. Decrease outlet pressure by removing blockage or increase high-pressure limit value.
09	Internal software fault	Fault — Pump is turned OFF. Default unit to °C or °F to reset operational parameters (see <i>Selecting the Temperature Unit (°C or °F)</i> , page 10. If problem persist, replace Control PCB.
10	Electronic power component fault (Triac)	Fault — Pump is turned OFF. Default unit to °C or °F to reset operational parameters (see <i>Selecting the Temperature Unit (°C or °F)</i> , page 10. If problem persist, replace Control PCB.
11	Internal probe fault	Fault — The internal RTD platinum probe has failed or the temperature control PCB is having a problem reading the probe signal. Pump is turned OFF. Contact supplier.
13	Communications fault	Fault — Pump is turned OFF. Default unit to °C or °F to reset operational parameters (see <i>Selecting the Temperature Unit (°C or °F)</i> , page 10. If problem persist, replace Control PCB.
14	ADC fault, internal probe	Fault — The internal RTD platinum probe has failed or the temperature control PCB is having a problem reading the probe signal. Pump is turned OFF. Contact supplier.
16	Front panel high ambient temperature alarm	Warning — The ambient temperature is higher than the set ambient limit. Pump is turned OFF. Lower ambient temperature or increase ambient temperature limit.

Enabling / Disabling the Local Lockout

This feature is used to prevent unauthorized or accidental changes to set point and other operational values. When enabled, these values can be viewed but not changed.

To enable the local lockout, press and hold the Select/Set Knob until LLO is displayed (approximately 5 seconds). Once enabled, LLO will appear momentarily when the Select/Set Knob is pressed to display the set point.

To disable the local lockout, press and hold the Select/Set Knob until CAn appears momentarily as local lockout status changes from enabled (LLO) to disabled (approximately 5 seconds).



CAUTION: The Local Lockout feature does not prevent set point changes entered via the RS-232 interface.

Routine Maintenance and Troubleshooting



WARNING: Hazardous voltages are present. Turn all power to the unit OFF and unplug the power cord from the electrical outlet when servicing unit. If electrical power is required (such as when measuring voltages across a live circuit), use extreme care when servicing the unit.



WARNING: Refer servicing to qualified service personnel.

Routine Maintenance

The Liquid-to-Liquid Cooler is designed to require a minimum of periodic maintenance.

Air Vents

To keep the system operating at optimum cooling capacity, the air vents should be kept free of dust and dirt. They should be checked on a regular basis and cleaned as required.

Process and Facility Line Strainers

To optimize flow and prevent pump and heat exchanger damage due to scale or foreign particles, “Y” strainers are installed on the inlets of both the process and facility lines. These strainers should be inspected on a regular basis and cleaned as required. How frequently filter cleaning will be necessary will depend on the environment, use of the unit, and the cleanliness of the process fluid and facility water.

In-Line Fluid Filter

A removable, highly efficient fluid filter is integrated into the fluid reservoir. To remove it for cleaning, simply remove the reservoir cap and lift the filter out of the reservoir. Rinse off accumulated particulate matter and reinstall. How frequently this strainer requires cleaning will depend on how and where the Liquid-to-Liquid Cooler is being used.

Fluid Level

The Liquid-to-Liquid Cooler’s fluid level should be periodically checked to determine if fluid needs to be added. Generally, fluid should be added whenever the reservoir is less than two-thirds full.

Software Version

To check the version of the software program installed in the unit:

1. Turn the unit to Standby by pressing the Power Button.
2. Press and hold the Power Button until the software version code appears.

To return to normal operation, release the Power Button. The unit will turn ON.

Draining the Unit



CAUTION: To ensure that internal damage does not occur during shipping or storage, water must be drained from all parts of the system and an antifreeze solution of technical grade ethylene glycol or propylene glycol added.



WARNING: Be sure to follow all appropriate safety and environmental guidelines when collecting and disposing of spent coolant.

Press the Power Button to turn the unit OFF and disconnect the power cord from the electrical outlet.

Disconnect the process in and process out lines at the rear panel of the Cooler.

Disconnect the facility water in and facility water out lines at the rear panel of the Cooler.

Remove the reservoir cap and siphon as much coolant as possible from the unit's reservoir.

Insert a compressed air hose into the opening on the inside bottom of the reservoir. Any coolant remaining in the Cooler's internal process lines will be blown out the process inlet and outlet.

Attach a compressed air hose to the facility water inlet or outlet. Any facility water remaining in the Cooler's internal facility water lines will be blown out the opposite connection.

Troubleshooting Chart

Problem	Cause	Corrective Action
Unit does not run (digital displays blank)	No power to unit	Check that the electrical cord is secure and connected to an operating electrical outlet. Check that Power Switch / Circuit Breaker on rear of unit is ON. Default the unit (see <i>Selecting the Temperature Unit</i> , page 10); contact factory if problem persists.
Unit does not run (three decimal points appear on temperature display, two decimal points on pressure/flow rate display)	Unit in Standby mode	Press Power Button on front panel.
No fluid circulation	Insufficient fluid in reservoir Blockage in circulating system Pump is not operating	Add fluid to reservoir. Remove blockage. Replace pump.
Insufficient circulation	Fluid viscosity too high External tubing diameter too small Restrictions in fluid lines Low line voltage	Replace with lower viscosity fluid. Replace with larger diameter tubing. Check and correct as required. Check and correct as required.
Unit does not cool or cooling is insufficient	Facility water line turned off Facility water line blocked or contaminated (algae growth) Excessive heat load Low or high line voltage	Check and correct as required. Remove blockages as required. Check that heat load does not exceed capacity of unit; correct as required. Check and correct as required.
EFL error code displayed	Liquid level in reservoir is low	Add fluid to reservoir.

Technical Information

Performance Specifications

	4100 Series Models	4200 Series Models
Operating Temperature:	5° to 50°C / 41° to 122°F	
Temperature Stability:	±0.4°C / ±0.7°F	
Temperature Units:	°C or °F	
Cooling Capacity @ 30°C:	10,000 watts 34,100 BTU/hr	20,000 watts 68,200 BTU/hr
Reservoir Size:	1.1 gal / 4.16 liters	
Standard Pump:	0.33 HP turbine	0.75 HP turbine
Typical Flow Rate:	60 Hz Units 50 Hz Units	3 GPM / 10 LPM 2.5 GPM / 9.4 LPM
Pump Bypass Pressure Setting:	50 PSI / 344.7 kPa	
Facility Water In @ 20°C:	2.64 GPM / 10 LPM minimum	
Piping Connections:	0.5 inch NPT	
Overall Dimensions (L x W x H):	27.6 x 14.5 x 22.6 inches / 70.1 x 36.8 x 57.4 cm	
Shipping Weight:	168 lbs / 76 kg	
Electrical Requirements:	208-240V, 50/60Hz, 4.0A	208-240V, 50/60Hz, 7.0A

Notes: Refer to the serial number plate on the rear of unit for model and electrical data.
Performance specifications determined at ambient temperature of 20°C / 68°F

Environmental Conditions

Indoor use only
 Maximum Altitude: 2000 meters
 Operating Ambient: 5° to 35°C
 Relative Humidity: 80% for temperatures to 30°C
 Over Voltage Category II
 Pollution Degree: 2
 Class 1: Residential, commercial, light industrial
 Class 2: Heavy industrial

Cooling Capacity vs. Facility Water Flow Rate

The following graph is applicable to both 4100 and 4200 Series Liquid-to-Liquid Coolers.

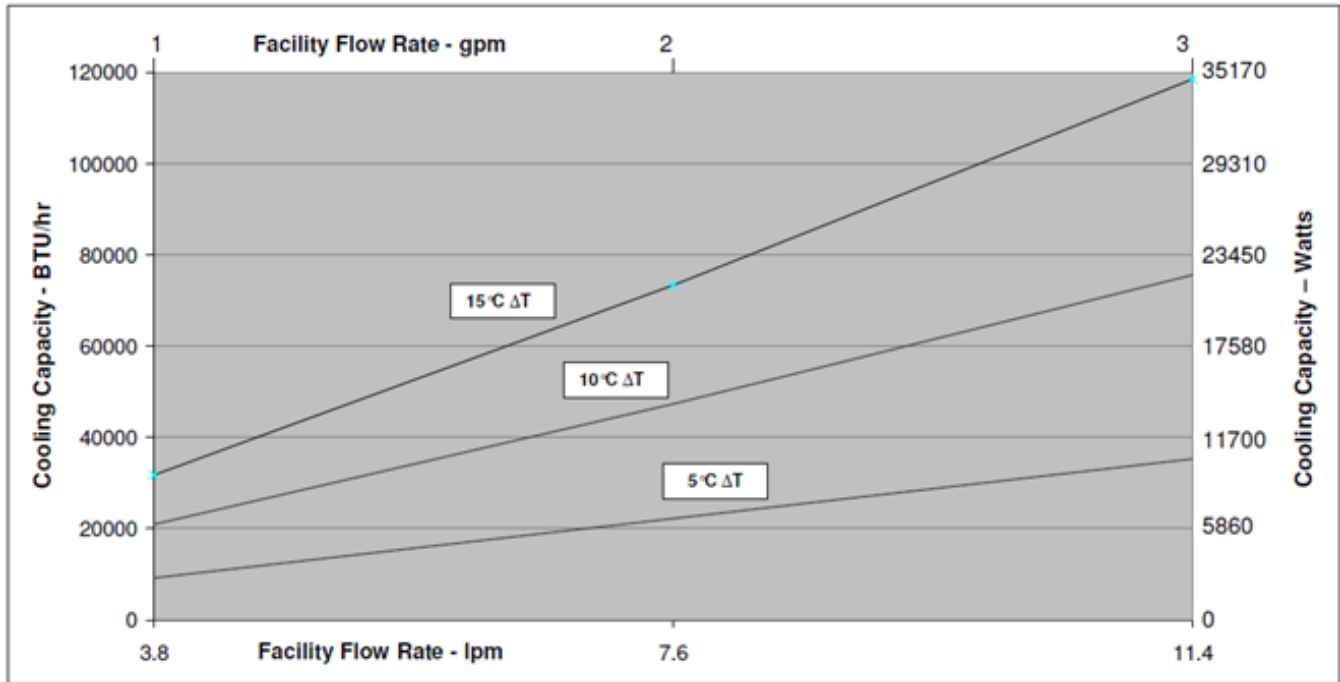

NOTE: Graph shows performance with full flow to process (no bypass).
 Facility water pressure drop through unit is 5 psi / 34.5 kPa at 16 GPM / 60.8 LPM.
 Facility water supply temperature is shown at 5°C, 10°C and 15°C below process temperature.

Wiring and Flow Diagram

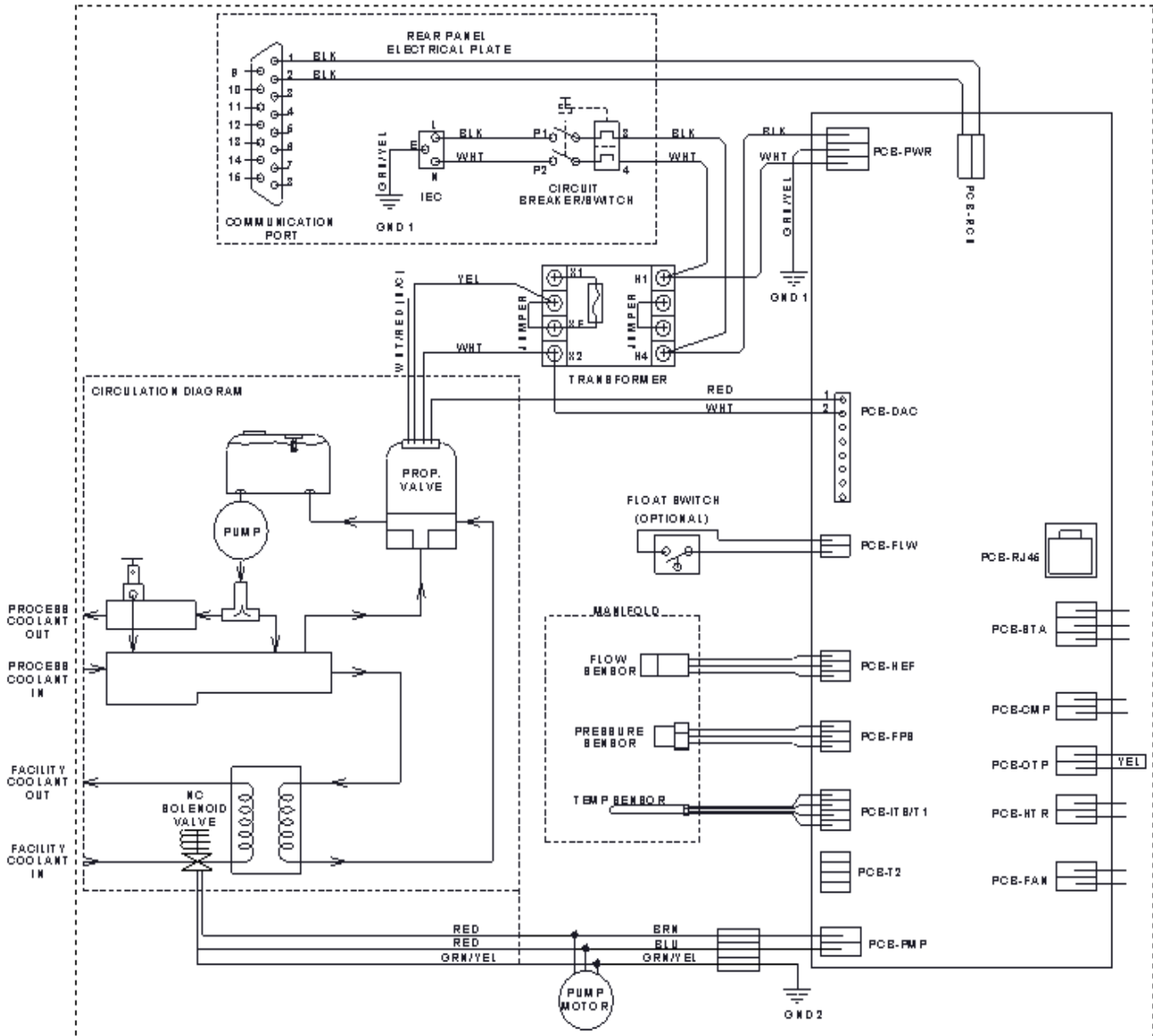

Reservoir Fluids



WARNING: Do not operate unit with any potentially flammable materials, as a fire hazard may result.

Fluid Description	Specific Heat			Normal Temperature Range	Extreme Temperature Range
	@ Fluid Temperature	BTU/lb°F	KJ/Kg°C		
Distilled water	50°C	1.00	4.18	10° to 90°C	2° to 100°C
Ethylene glycol (50/50 mix with distilled H ₂ O)	-20°C	0.78	3.26	-25° to 100°C	-30° to 115°C
Ethylene glycol (30/70 mix with distilled H ₂ O)	0°C	0.89	3.72	0° to 95°C	-15° to 107°C
Propylene glycol (50/50 mix with distilled H ₂ O)	-10°C	0.83	3.47	-20° to 100°C	-30° to 115°C
Propylene glycol (30/70 mix with distilled H ₂ O)	5°C	0.92	3.85	5° to 90°C	-10° to 107°C



WARNING: DO NOT USE THE FOLLOWING LIQUIDS

- Automotive antifreeze with additives**
- Hard tap water**
- Deionized water with a specific resistance > 1 meg ohm
- Any flammable fluids
- Concentrations of acids or bases
- Solutions with halides: chlorides, fluorides, bromides, iodides or sulfur
- Bleach (Sodium Hypochlorite)
- Solutions with chromates or chromium salts
- Glycerine
- Syltherm fluids

** At temperatures above 40°C, additives or mineral deposits may develop. If deposits are allowed to build up, the unit may overheat and fail. Higher temperatures and higher concentrations of additives will hasten deposit build up.

Replacement Parts

Description	Part Number
Operator's Manual	110-497
0.33 HP Turbine Pump, bronze	215-305
0.75 HP Turbine Pump, bronze	215-499
Circuit Breaker, 15 amp	215-330
Line cord, IEC-320-19 female/NEMA 6-15P	225-230
Fluid Filter	565-102
Tank Assembly, stainless steel (no insulation)	540-504
Reservoir Low Liquid Level Switch	525-550
Bypass Valve	750-175
3-way Proportional Valve	775-513
Heat Exchanger	750-193

PolyScience Fluids

Circulating Bath Fluids	Quantity	Part Number
polyclean CLARIFIER	8 oz / 236 ml	004-300040
polyclean CLARIFIER	Twelve 8 oz / 236 ml bottles	004-300041
polycool EG -25 (ethylene glycol)	1 gal / 4.5 liter	060340
polycool PG -20 (propylene glycol)	1 gal / 4.5 liter	060320
polycool MIX -25 (50/50 blend polycool EG -25 / H ₂ O plus polyclean CLARIFIER)	Five 0.5 gal / 2.27 liter bottles	004-300060

Optional Serial Output (RS-232)

Serial Connector — A 9-pin D-connector (optional) is provided on the back panel of the Liquid-to-Liquid Cooler for RS-232 data communication. A serial cable that uses only the following pins should be used to connect the unit to the computer:

- Pin #2 — data read (data from computer)
- Pin #3 — data transmit (data to computer)
- Pin #5 — signal ground

RS-232 Protocol — The controller uses the following RS-232 protocol:

- Data bits — 8
- Parity — none
- Stop bits — 1
- Flow control — none
- Baud rate — selectable (Liquid-to-Liquid Cooler and PC baud rates must match).

Communications Commands — Commands must be entered in the exact format shown. Do not send a [LF] (line feed) after the [CR] (carriage return). Be sure to follow character case exactly. A response followed by an exclamation point (!) indicates that a command was executed correctly. A question mark (?) indicates that the Cooler could not execute the command (either because it was in an improper format or the values were outside the allowable range). A response must be received from the Liquid-to-Liquid Cooler before another command can be sent. All responses are terminated with a single [CR].

Command Description	Command Format	Values	Return Message
Set command echo ON	SE1[CR]	1	![CR]
Set command echo OFF	SE0[CR]	0	![CR]
Turn unit ON	SO1[CR]	1	![CR]
Turn unit OFF	SO0[CR]	0	![CR]
Set set point	SSxxx[CR]	5-50°C (41° to 122°F)	![CR]
Read set point temperature	RS[CR]	----	xx.x[CR]
Read temperature	RT[CR]	----	xx.x[CR]
Read temperature units	RU[CR]	C or F	C[CR] or F[CR]
Read status	RW[CR]	1 = Run 0 = Standby	1[CR] or 0[CR]
Read pump pressure in PSI	RP[CR]	----	xx.x[CR]
Read pressure in kPa	RK[CR]	----	xx.x[CR]
Read flow in GPM	RG[CR]	----	xx.x[CR]
Read flow in LPM	RL[CR]	----	xx.x[CR]
Read ambient temperature on Control PCB	RA[CR]	----	xx.x[CR]
Read fault status (see <i>Display, Alarm and Error Messages</i> , page 14)	RF [CR]	00 = system OK 02-16 = Fault	![CR]

Equipment Disposal (WEEE Directive)



or



This equipment is marked with the crossed out wheeled bin symbol to indicate it is covered by the Waste Electrical and Electronic Equipment (WEEE) Directive and is not to be disposed of as unsorted municipal waste.

Any products marked with this symbol must be collected separately, according to the regulatory guidelines in your area.

It is your responsibility to correctly dispose of this equipment at lifecycle-end by handing it over to an authorized facility for separate collection and recycling. It is also your responsibility to decontaminate the equipment in case of biological, chemical and/or radiological contamination, so as to protect the persons involved in the disposal and recycling of the equipment from health hazards. By doing so, you will help to conserve natural and environmental resources and you will ensure that your equipment is recycled in a manner that protects human health.

Requirements for waste collection, reuse, recycling, and recovery programs vary by regulatory authority at your location. Contact your local responsible body (e.g., your laboratory manager) or authorized representative for information regarding applicable disposal regulations.

Service and Technical Support

If you have followed the troubleshooting steps and your Liquid-to-Liquid Cooler fails to operate properly, contact the supplier from whom the unit was purchased. Have the following information available for the customer service person:

- Model, Serial Number, and Voltage (from back panel)
- Date of purchase and your purchase order number
- Suppliers' order number or invoice number
- A summary of your problem

Warranty

The manufacturer agrees to correct for the original user of the product, either by repair (using new or refurbished parts), or at the manufacturer's election, by replacement (with a new or refurbished product), any defects in material or workmanship which develop during the warranty period. The standard warranty is twenty-four (24) months after delivery of the product. In the event of replacement, the replacement unit will be warranted for the remainder of the original warranty period or ninety (90) days, whichever is longer. For purposes of this limited warranty, "refurbished" means a product or part that has been returned to its original specifications. In the event of a defect, these are your exclusive remedies.

If the product should require service, contact the manufacturer's/supplier's office for instructions. When return of the product is necessary, a return authorization number is assigned and the product should be shipped, transportation charges pre-paid, in either its original packaging or packaging affording an equal degree of protection to the indicated service center. To insure prompt handling, the return authorization number must be placed on the outside of the package. A detailed explanation of the defect should be enclosed with the item.

The warranty shall not apply if the defect or malfunction was caused by accident, neglect, unreasonable use, improper service, acts of God, modification by any party other than the manufacturer, or other causes not arising out of defects in material or workmanship.

EXCLUSION OF IMPLIED WARRANTIES. THERE ARE NO WARRANTIES, EXPRESSED OR IMPLIED, INCLUDING, BUT NOT LIMITED TO, THOSE OF MERCHANTABILITY OR FITNESS FOR A PARTICULAR PURPOSE WHICH EXTEND BEYOND THE DESCRIPTION AND PERIOD AS STATED IN THE OPERATOR'S MANUAL INCLUDED WITH EACH PRODUCT.

LIMITATION ON DAMAGES. THE MANUFACTURER'S SOLE OBLIGATION UNDER THE WARRANTY IS LIMITED TO THE REPAIR OR REPLACEMENT OF A DEFECTIVE PRODUCT AND THE MANUFACTURER SHALL NOT, IN ANY EVENT, BE LIABLE FOR ANY INCIDENTAL OR CONSEQUENTIAL DAMAGES OF ANY KIND RESULTING FROM USE OR POSSESSION OF THIS PRODUCT.

Some states do not allow: (A) limitations on how long an implied warranty lasts; or (B) the exclusion or limitation of incidental or consequential damages, so the above limitations or exclusions may not apply to you. This warranty gives you specific legal rights and you may have other rights that vary from state to state.

Manufactured by:

PolyScience

6600 W. Touhy Avenue Niles, IL 60714 U.S.A.

1-800-229-7569 • 1-847-647-0611

www.polyscience.com