

IRISYS

Multi-Purpose Thermal Imager

IRI 4010

User Manual



Safety Warning:

The equipment described in this document uses a Class 2 laser. Under no account should anyone look directly into the laser beam or the laser beam exit aperture, irreversible damage to the eye may occur. The laser should not be operated when there are personnel in the imager's field of view.

Caution – use of controls or adjustments or performance of procedures other than those specified in this document may result in hazardous laser radiation exposure.

Class 2 laser product.
Complies with IEC/EN 60825-1
(2001).

Conforms to USA 21 CFR 1040.10
and 1040.11 except for deviations
pursuant to laser notice No. 50 dated
July 26th 2001.



InfraRed Integrated Systems Ltd
Park Circle, Tithe Barn Way
Swan Valley
Northampton
NN4 9BG
Tel: (01604) 594 200
Fax: (01604) 594 210
Email: sales@irisys.co.uk

© 2006 InfraRed Integrated Systems Ltd. No part of this publication may be reproduced without prior permission in writing from InfraRed Integrated Systems Ltd. This document gives only a general description of the products and except where expressly provided shall form no part of any contract. From time to time changes may be made in the products.

IRISYS[®]
InfraRed Integrated Systems

World Leaders in
ABD
Array-Based Detectors

Contents:

1	INTRODUCTION	3
2	GETTING STARTED.....	3
2.1	UNPACKING.....	3
2.2	POWERING THE IRI 4010	4
2.2.1	Using Battery Power – Inserting the Battery	4
2.2.2	Using AC Mains Power.....	4
2.2.3	Battery Charging.....	5
3	OPERATING THE IRI 4010 THERMAL IMAGER	5
3.1	HARDWARE	5
3.2	SWITCHING ON THE IRI 4010.....	6
3.3	INFORMATION SPLASH SCREEN	6
3.4	USING THE IRI 4010 THERMAL IMAGER.....	7
3.4.1	Focusing	7
3.4.2	Screen Display Items	7
3.4.3	Buttons.....	8
3.4.4	IRI 4010 Hot Button Operation	9
3.4.4.1	Hot Button 1 – Zoom.....	9
3.4.4.2	Hot Button 2 – Freeze/Save	9
3.4.4.3	Hot Button 3 - Direction Buttons Control.	9
3.4.4.4	Hot Button 4 – Auto / Manual	9
3.4.5	Directional Buttons	10
3.4.6	Image Adjustment.....	10
3.4.6.1	Level and Span Definitions.....	10
3.4.7	Menu Operation and Functions.....	11
3.4.7.1	Measurement Settings.....	11
3.4.7.2	Camera Settings	12
3.4.7.3	Image Browser Menu.....	12
3.4.7.4	Clock/Calendar Settings.....	12
3.4.8	Using the Laser Pointer	13
3.4.9	Advanced User Functions.....	13
3.4.9.1	Brightness & Contrast Definitions.....	13
3.5	TECHNICAL	15
3.5.1	Field Of View	15
4	THERMAL IMAGE TRANSFER FROM IRI 4010 TO A PC	16
4.1	SD CARD.....	16
4.2	USB CABLE.....	16
5	USING THE IRI 4010 THERMAL IMAGER WITH A PC	17
5.1	PC REQUIREMENTS	17
5.2	INSTALLATION OF SOFTWARE ONTO PC	17
5.3	OPERATING “IRISYS 4000 SERIES IMAGER” PC SOFTWARE	17
5.3.1	Menus and Toolbar	18
5.3.1.1	Menus	18
5.3.1.2	Toolbar.....	27
6	EMISSIONITY LOOKUP TABLE	28
7	CUSTOMER FEEDBACK.....	29

1 Introduction

This user manual describes the operation of the IRI 4010 multi-purpose infrared thermal imager and its associated software and accessories.

2 Getting Started

2.1 Unpacking

After unpacking the IRI 4010 carrying case, you will find the standard items as shown in Figure 1.



Figure 1: Contents of the IRI 4010 Multi-Purpose Thermal Imager

Inspect all the items. If any item is damaged or missing, please notify your dealer immediately.

2.2 Powering the IRI 4010

The IRI 4010 thermal imager operates with a rechargeable battery, or from AC mains power.

2.2.1 Using Battery Power – Inserting the Battery

1. Open up the battery compartment on the bottom of the IRI 4010 thermal imager by sliding the battery cover off as indicated in Figure 2.
2. Insert the rechargeable battery as shown below.
3. Replace the battery cover.
4. The above method also applies to replacing the battery, but make sure the IRI 4010 is switched off before removing the battery.

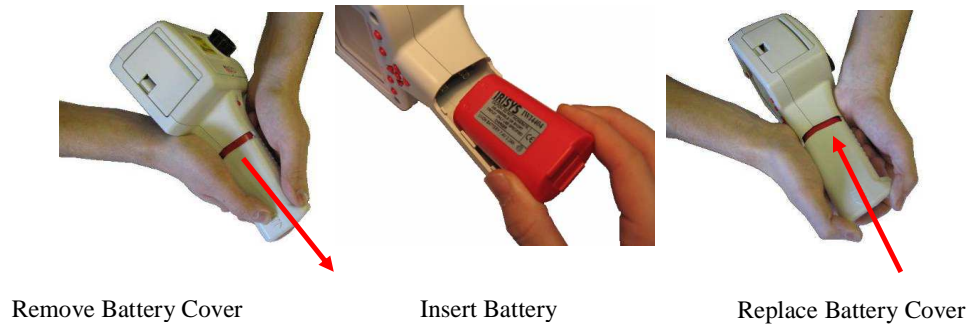

Figure 2: Inserting the Rechargeable Battery.

NOTES:

- The rechargeable battery will power the IRI 4010 thermal imager for approximately 4 hours.
- The battery indicator appears on the screen when the imager is switched on. It has the following four stages and each stage corresponds to approximately one hour of operation.

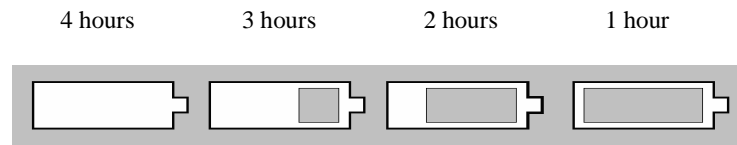

Figure 3: Battery Indicator Levels.

- ❖ **CAUTION:** If the IRI 4010's battery indicator flashes, the battery power is running low and it needs to be charged or replaced within 10 minutes.

2.2.2 Using AC Mains Power

1. Make sure the thermal imager is turned off.
2. Connect the provided 12V power supply into the socket on the side of the IRI 4010 imager; see Figure 4.
3. Attach the appropriate supplied regional adapter to the power supply.
4. Plug the power supply into a mains socket.
5. Switch on the thermal imager.

- ❖ **CAUTION:** When using AC mains, use only the power supply included with the IRI 4010. Using other power supplies may damage the IRI 4010 Thermal Imager.

NOTE:

- The mains power supply included with the IRI 4010 is for powering the IRI 4010; it will also recharge the battery (see Section 2.2.3).

2.2.3 Battery Charging

- The IRI 4010's battery can be charged in the imager by inserting the included 12V power supply into the DC socket under the cover on the side of the IRI 4010 imager; see Figure 4. It takes approximately 4 hours to fully charge a fully depleted battery if the imager is switched off. Charging the battery with the imager switched on takes longer.

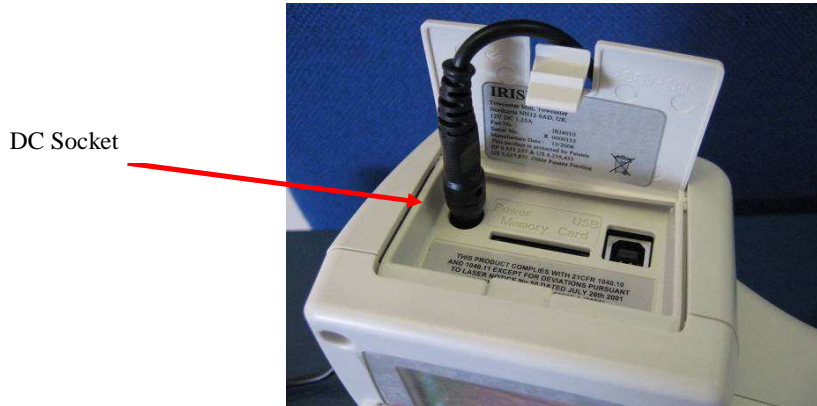

Figure 4: Connecting the Mains AC Power Supply

3 Operating the IRI 4010 Thermal Imager

3.1 Hardware

The IRI 4010 system is designed for use as a handheld thermal imager. Thermal images stored on the supplied memory card can be transferred to a PC or laptop computer using the supplied memory card reader. PC software is supplied for viewing and analysis of saved thermal images.



Figure 5: The IRI 4010 Hardware.

Safety notice: The laser used in this device is designated Class 2. Under no circumstances should personnel look straight into the laser.

3.2 Switching on the IRI 4010



- The IRI 4010 features an On/Off power button above the display. The IRI 4010 is switched on and off by holding the power button down for more than one second.
- The IRI 4010 takes approximately twenty seconds to become operational. During this time a number of audible clicks will be heard. This is normal as it is part of the calibration procedure. After start-up these clicks continue, but become much less frequent.
- For best measurement results the imager should be switched on at least 5 minutes before use.

Figure 6: Switching on the IRI 4010

3.3 Information Splash Screen

The IRI 4010's splash screen appears for approximately 20 seconds when the imager is switched on. It displays the time and date so the user can check that any images saved will be recorded with the correct time and date. The time and date must be manually set (see Section 3.4.7.4).

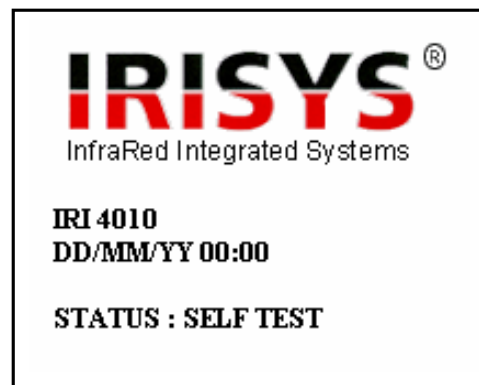

Figure 7: Splash Screen

3.4 Using the IRI 4010 Thermal Imager

3.4.1 Focusing

If the imager is not focused, the image quality will be poor and temperature measurements will not be accurate.



Rotating the lens in a clockwise direction (from front view) focuses the imager at longer distances up to infinity. Rotating the lens in the opposite direction focuses the imager at shorter distances down to a minimum of 30 cm.

Rotate the lens until the image has the best definition, and has the sharpest contrast at object edges.

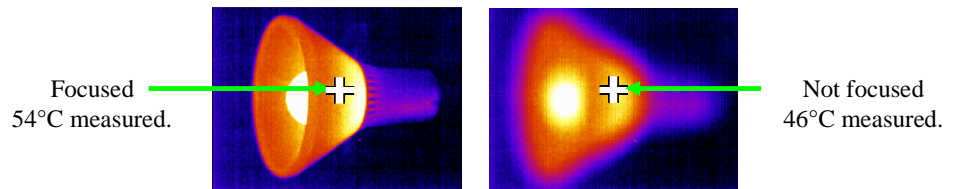

Figure 8: Focusing

3.4.2 Screen Display Items

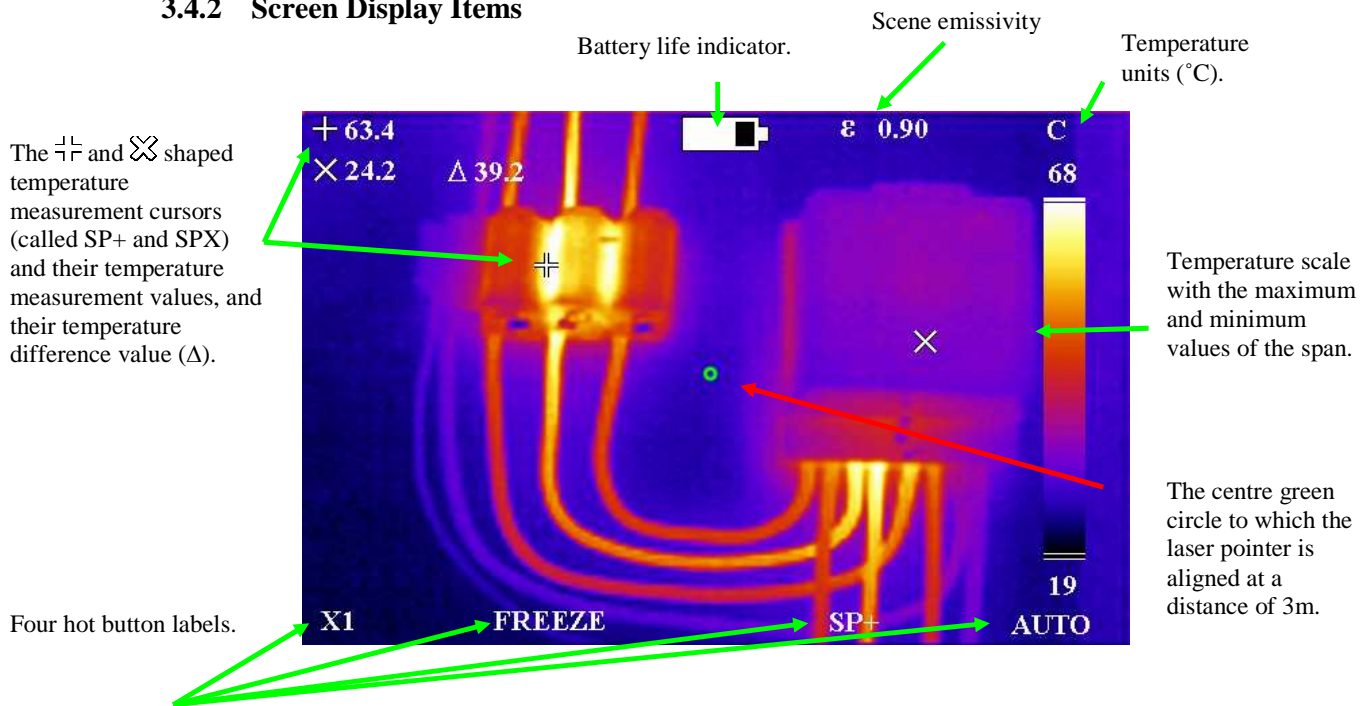

Figure 9: Screen Display Items

❖ **CAUTION:** The calibrated temperature output is the figure adjacent to the cursor identifier; the temperature scale and display colours are indicators only.

3.4.3 Buttons

Operation of the IRISYS 4010 imager application is by means of the 4 hot buttons, the 4 directional buttons, the menu button and the laser button (see Figure 10).

- The hot buttons are mainly used to give quick control of:
 1. zoom function,
 2. image capture,
 3. measurement cursor selection
 4. auto/manual modes.

It should be noted that the hot button functions change in different modes of operation. See Section 3.4.4 for more information.

- The directional buttons are used to:
 1. move the position of the measurement cursors,
 2. adjust the level, span, brightness and contrast ,
 3. navigate around the menus.

See Section 3.4.5 for more information about the directional buttons and see Section 3.4.6.1 for definitions of level and span, and Section 3.4.9.1 for definitions of brightness and contrast.

- The menu button opens the menus. See Section 3.4.7 for more information.
- The laser button must be held down to turn the laser on. See Section 3.4.8 for more information.

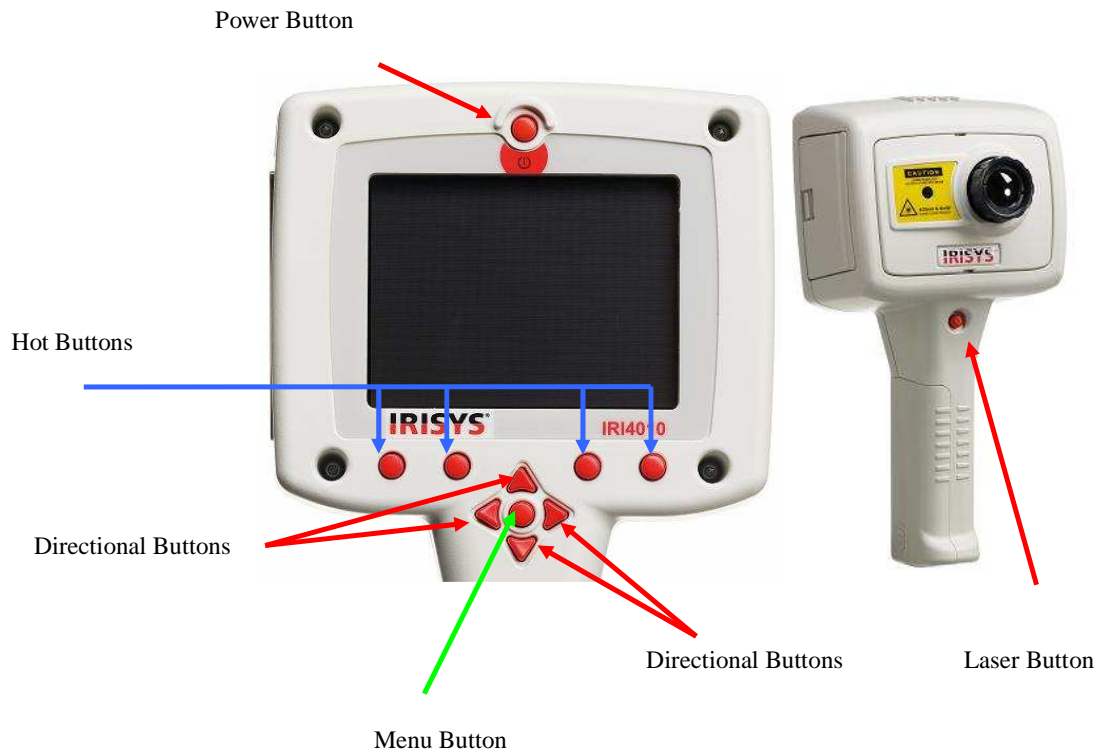

Figure 10: Buttons

3.4.4 IRI 4010 Hot Button Operation

This section describes some of the basic functions of the IRI 4010. The IRI 4010's hot buttons are labelled 1 to 4 from left to right for the purposes of this user manual. Their function is displayed as hot button labels on the IRI 4010's display. Their labels can change in different modes of operation.



Figure 11: Hot Buttons

3.4.4.1 Hot Button 1 – Zoom

This hot button toggles the zoom feature between off (X1) and on (X2). When zoom X2 is selected the central region of the thermal image expands to fill the display as in Figure 12, and the hot button label displays “X2”.

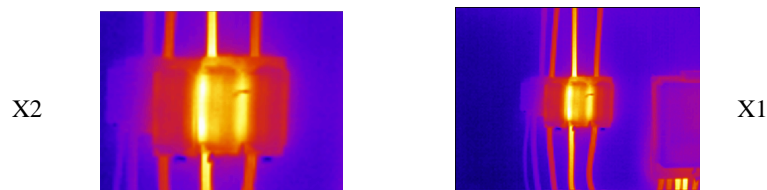

Figure 12: Zoom Function

3.4.4.2 Hot Button 2 – Freeze/Save

Hot button 2 freezes the live thermal image. It is possible to edit the image in freeze mode before saving it. Pressing hot button 2 again saves the image as an image.iri file to the SD card, whilst pressing hot button 1 instead rejects the image. The file saving takes a few seconds, and the file name is given a sequential number. See Section 5.3.1.1.4 for how to save an image direct to a PC via the USB cable.

3.4.4.3 Hot Button 3 - Direction Buttons Control.

Hot button 3 selects either of the temperature measurement cursors (SP+ or SPX), or either L-S (temperature level and span) when in manual mode or B-C (thermal image brightness & contrast) when in auto mode. The 4 direction buttons are then used to adjust the position of the selected cursor, the level & span, or the brightness & contrast depending on which mode is selected. Note that SPX must be enabled in the Measurement Settings menu, and that the B-C control is an advanced user function that must be enabled before use in the Camera Settings menu.

3.4.4.4 Hot Button 4 – Auto / Manual

This hot button toggles between auto and manual mode. In auto mode, the imager continually adjusts the level and span to achieve the optimum image. In manual mode it is possible to manually control the level and span to produce the image to your requirements. See Section 3.4.6.1 for definitions of level and span, and Section 3.4.9.1 for definitions of brightness and contrast. The preset brightness and contrast of the auto mode can be adjusted to suit your preferences (See Section 3.4.9.1).

3.4.5 Directional Buttons

The directional buttons (up, down, left & right – see Figure 13) are used for three different functions.

1. If hot button 3 is set to either SP+ or SPX, the directional buttons control the position of the selected temperature cursor. (Selection displayed above hot button 3).
2. If hot button 3 is set to L-S, “up” and “down” control the manual mode’s image temperature level, and “left” and “right” control the temperature span. See Section 3.4.6.1 for details. If hot button 3 is set to B-C, “up” and “down” control the auto mode’s target image thermal brightness, and “left” and “right” control the target thermal contrast. See Section 3.4.9.1 for details.
3. If the menu is displayed, the directional buttons control the movement of the highlighted cursor and adjustment of the highlighted option (see Section 3.4.7).

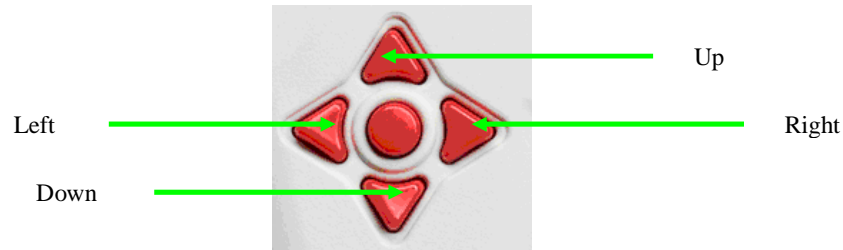

Figure 13: Directional Buttons

3.4.6 Image Adjustment

3.4.6.1 Level and Span Definitions

When hot button 4 is set to manual the IRI 4010’s image settings can be manually controlled by adjusting the level and span. When hot button 3 shows L-S, the “right” and “left” buttons respectively will increase and decrease the span of the image (4°C in the example in Figure 14). The “up” and “down” buttons will increase and decrease the thermal level of the image (29°C in the example in Figure 14).

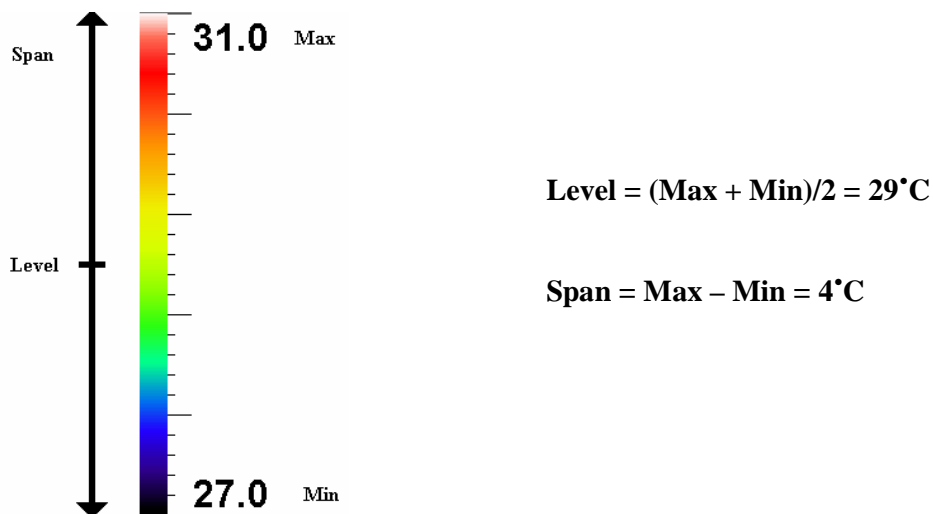

Figure 14: Level and Span

The IRI 4010’s image settings are fully automatic when hot button 4 is set to auto. The auto mode automatically adjusts the level and span to display a presentable image.

3.4.7 Menu Operation and Functions

The main menu structure is opened by pressing the menu button in the centre of the directional buttons.

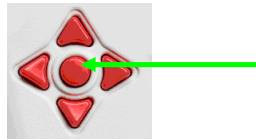

Figure 15: Menu Button

There are four sub-menus, which contain the functions listed in Table 1.

Measurement Settings	Camera Settings	Image Browser	Clock/Calendar
Emissivity	Colour Palette	View	Year
Reflected Temperature	Auto Power	Delete	Month
Spot X	Factory Settings		Day
Temperature Units	Image Only		Hour
Area	B - C		Minute
	Cursor Reset		Date Format
			Time Format

Table 1: Menu Functions

The menu functions are selected by moving the highlighted cursor using the up and down directional buttons. Menu items are edited using hot buttons 2 & 3 which are labelled + and -. Hot button 1 is always available to take you “back” one menu sub-level, whilst hot button 4 is always available to “exit” the menus completely. Figure 16 shows an example screenshot from the Measurement Settings menu, with the highlighted cursor on the emissivity adjuster.

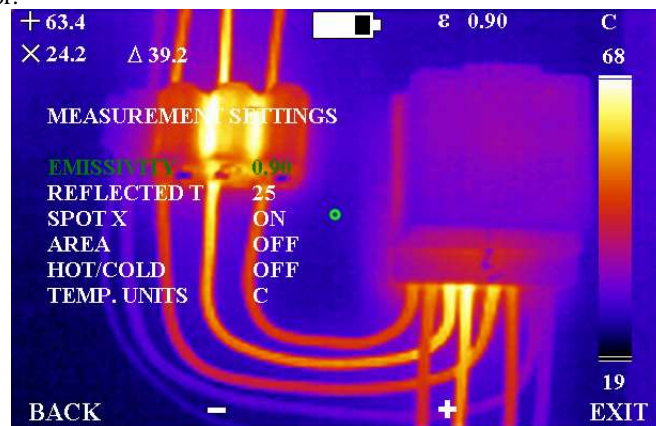

Figure 16: Menu Operation

3.4.7.1 Measurement Settings

- Emissivity – The user can select the emissivity for the material being imaged. To achieve correct temperature measurement the emissivity value must be set correctly. An emissivity lookup table is included in Section 6.

NOTE: Caution should be observed in using the emissivity control – the user should explore the effect on the observed temperature of an object when different emissivities are selected. Low values of emissivity should be used only with extreme caution as large errors in temperature readings may be obtained with only small errors in emissivity. Care should also be taken to avoid reflections from hot/cold objects in the vicinity.

- Reflected T – When the emissivity is set to values less than 1.0, measurement accuracy can be further improved by setting the reflected temperature compensation. The reflected temperature is the temperature being “seen” by the object being imaged. The value entered must be within the range -20°C to 200°C or equivalent in °F or K.
- Spot X - Toggle the second temperature cursor (SPX) display on/off the screen. When SPX is displayed the temperature difference (Δ) between SP+ and SPX is also displayed.
- Area – This removes the temperature measurement cursors from the image, and instead displays a small rectangle in the centre of the image. The cursor measurement readout changes to display the maximum and the minimum temperature within the rectangle. When a saved image is browsed in area analysis mode, the average temperature for the rectangle (\bar{x}) is also displayed.
- Temperature Units – Select between degrees Celsius, degrees Fahrenheit and Kelvin.

3.4.7.2 Camera Settings

- Colour Palette – The user can select one of four possible colour options. They are Rainbow, Ironbow, Greyscale (monochrome) or HC Rainbow (high contrast).
- Auto Power – Turns the imager off if it has been left on without a button press for 20 minutes.
- Factory Settings – For the convenience of the user, many settings are persistent, i.e. the settings and values are remembered when the IRI 4010 is switched off. Selecting the factory settings function restores the imager to its factory default settings.
- Image only - This option displays the image and the hot button labels only.
- Brightness & Contrast – This option selects whether the advanced user function of brightness and contrast control is available on hotkey 3 when in auto mode (see Section 3.4.9.1).
- Cursor Reset – Select this option to restore the cursor (or 2 cursors) to their default positions.

3.4.7.3 Image Browser Menu

- This browser shows a list of file numbers found on the SD memory card, starting with the most recent image. It is possible to scroll through the list and choose to view images or to delete image files.

3.4.7.4 Clock/Calendar Settings

- Set Clock – The clock can be set so images are saved with the time and date of image capture.
- Date Format – choose between dd/mm/yy or mm/dd/yy.
- Time Format – 12 Hour / 24 Hour clock

3.4.8 Using the Laser Pointer

When the IRI 4010 is switched ‘ON’, the laser may be activated by pressing and holding down the red laser button.



The laser pointer is used to illuminate and identify features in the image. The laser pointer illuminates the area of the scene that coincides with the green circle indicator on the display – see Figure 9.

NOTE: The laser is aligned to objects at a distance of 3m from the front of the imager.

Figure 17: Laser Pointer

3.4.9 Advanced User Functions

3.4.9.1 Brightness & Contrast Definitions

The thermal brightness is the colour at the centre of the colour scale, (the default thermal brightness for the rainbow colour palette is a yellow/green colour see Figure 18). Note that the brightness of the image does not refer to the brightness of the screen. For a greyscale image, brighter means whiter, and for a rainbow image, yellow is brighter than blue, and red is brighter than yellow. The contrast is the amount of the colour bar that the image uses, and it uses the whole colour bar by default.

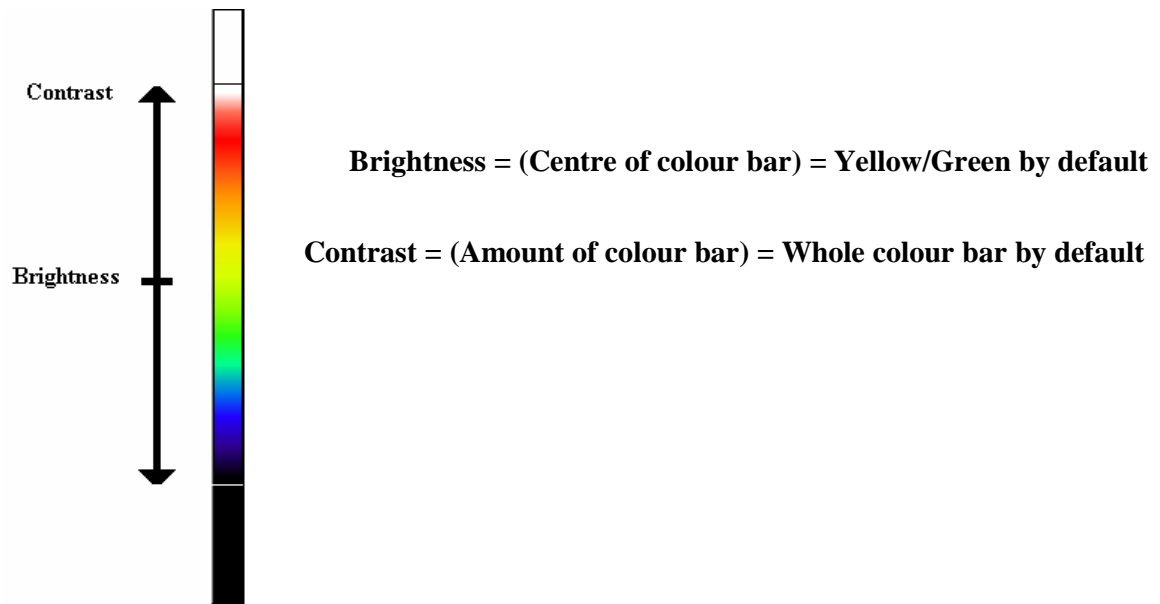

Figure 18: Brightness & Contrast Definitions

The target thermal brightness and contrast of the auto mode can be manually set when B – C is toggled to “ON” in the camera settings menu. This enables hot button 3 to be toggled to B-C when the imager is in auto mode. In this case the “right” and “left” buttons will increase and decrease the contrast of the image. The “up” and “down” buttons will increase and decrease the thermal brightness of the image.



Edit the Contrast	Edit the Brightness
<p data-bbox="483 302 646 327">Default contrast</p> 	<p data-bbox="1036 302 1214 327">Default brightness</p> 
<p data-bbox="293 644 829 726">Increasing the contrast uses more of the outer colours of the colour palette i.e. black and white in the rainbow example.</p> 	<p data-bbox="875 644 1378 701">Increasing the thermal brightness uses more of the upper half of the colour bar.</p> 
<p data-bbox="293 1043 829 1125">Reducing the contrast uses less of the outer colours of the colour palette, and uses more of the central colours i.e. green and yellow in the rainbow example.</p> 	<p data-bbox="875 1043 1378 1125">Decreasing the thermal brightness uses more of the lower half. See the examples in Figure 18 for more information.</p> 

Figure 19: These 6 figures show the effect of increasing and decreasing the auto mode’s brightness and contrast.

The practical advantage of this is that the user can completely control the appearance of the image without having to adjust the level and span manually when viewing different scene temperatures.

NOTE: The brightness and contrast can be reset back to the defaults by pressing hot button 4 to manual mode, and then hot button 4 again back to auto mode.

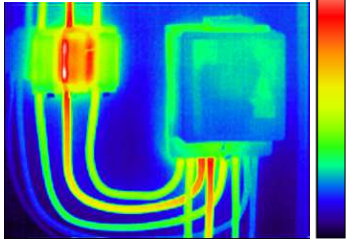
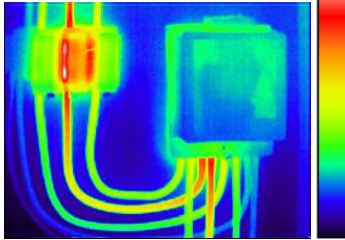
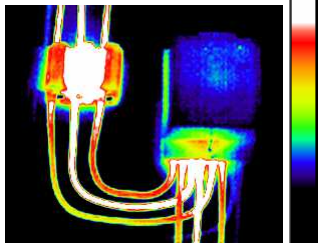
3.5 Technical

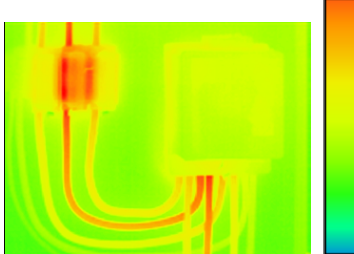
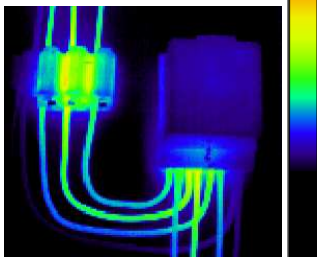
3.5.1 Field Of View

The IRI 4010 has a 20° x 15° Field of View, and a 160 x 120 (19200) pixel detector.

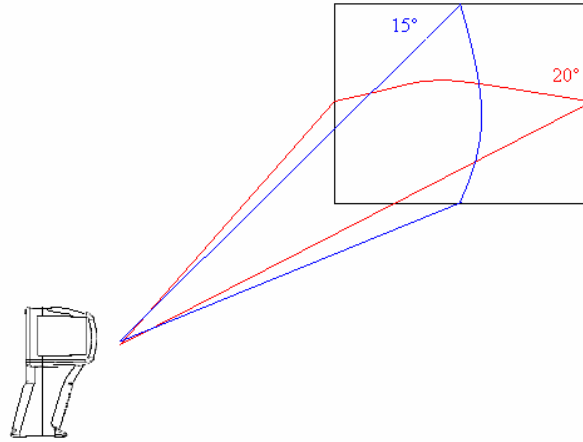

Figure 20: Field of View

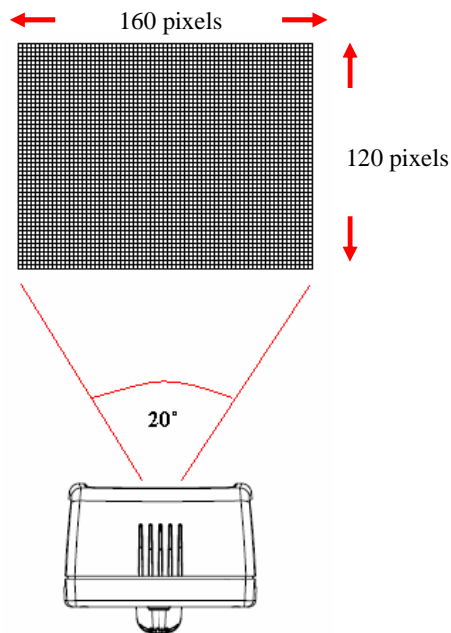

Figure 21: 19200 Pixel Array

4 Thermal Image Transfer from IRI 4010 to a PC

4.1 SD Card

The Secure Digital (SD) memory card is the IRI 4010's storage device for thermal images. This is also used to transfer thermal images to a PC when used with the SD card reader. Note that the imager will not be able to save thermal images without the SD card installed.

1. Save thermal images onto the SD card as described in Section 3.4.4.2.
2. Remove the SD card.
3. Slot the SD card into the SD/MMC slot on the USB SD card reader supplied, making sure of the correct orientation.



Figure 22: Inserting the SD card.

4. Insert the USB connector of the SD card reader into a USB port on the Windows 2000 / XP PC, using the extender USB cable if required.
5. Follow the card reader's installation instructions if prompted by Windows.
6. Either open My Computer and copy the .iri files from the SD card to the PC (recommended), or leave the SD card in place whilst the "IRISYS 4000 Series Imager" PC software is running and open the files directly from the SD card.

NOTE: Image files must retain their file name (TIXXXXXX.iri). If they are renamed on the PC, they will no longer be readable by the imager.

4.2 USB Cable

A live thermal image can be saved directly to a PC using the USB cable provided connected between a PC's USB port, and the imager's USB socket (see Figure 23). The "IRISYS 4000 Series Imager" PC software must be installed onto the Windows 2000 / XP PC before making this connection. See Section 5.3 for more information.



**USB Socket, for
connecting to a PC**

Figure 23: Slots and Sockets

5 Using the IRI 4010 Thermal Imager with a PC

5.1 PC Requirements

The PC should be IBM compatible running MS Windows XP or 2000, with a CD drive, and a USB port or an SD card reader. The “IRISYS 4000 Series Imager” application can be used for analysis of images previously saved onto an IRI 4010 SD card, or for downloading a live thermal image from the IRI 4010 via a USB cable.

5.2 Installation of Software onto PC

The software is supplied on a mini CD-Rom.

1. Insert the supplied mini CD-Rom into the PC’s CD-Drive.
2. Double click on ‘My Computer’ and then on the CD-Drive.
3. Double click on ‘4000 PC Setup.exe’.
4. Follow the on screen prompts to complete the installation.

NOTE:

- The IRISYS 4000 Series Imager software will by default be installed into the following path:

C:\Program Files\IRISYS\IRISYS 4000 Series Imager

- The above path and name can be changed during the installation, but it is advisable to leave it as the default. The installation will also put a ‘Shortcut Icon’ onto your PC’s desktop to allow quick and easy start-up of the software.

5.3 Operating “IRISYS 4000 Series Imager” PC Software

Launch the IRISYS 4000 Series Imager program from the Desktop icon,



Figure 24: Desktop Icon

or from:

- **START/PROGRAMS/IRISYS/IRISYS 4000 Series Imager**

Alternatively it is possible to run the program by using Windows Explorer to find .iri files on your PC and then double-clicking an .iri file icon:



Figure 25: .Iri File Icon

The application executes and it looks like Figure 26, with the options window visible, and with empty frames for the image, colour bar and thermal histogram. The application window includes the file name if the file has been saved; otherwise it reads “Untitled”.

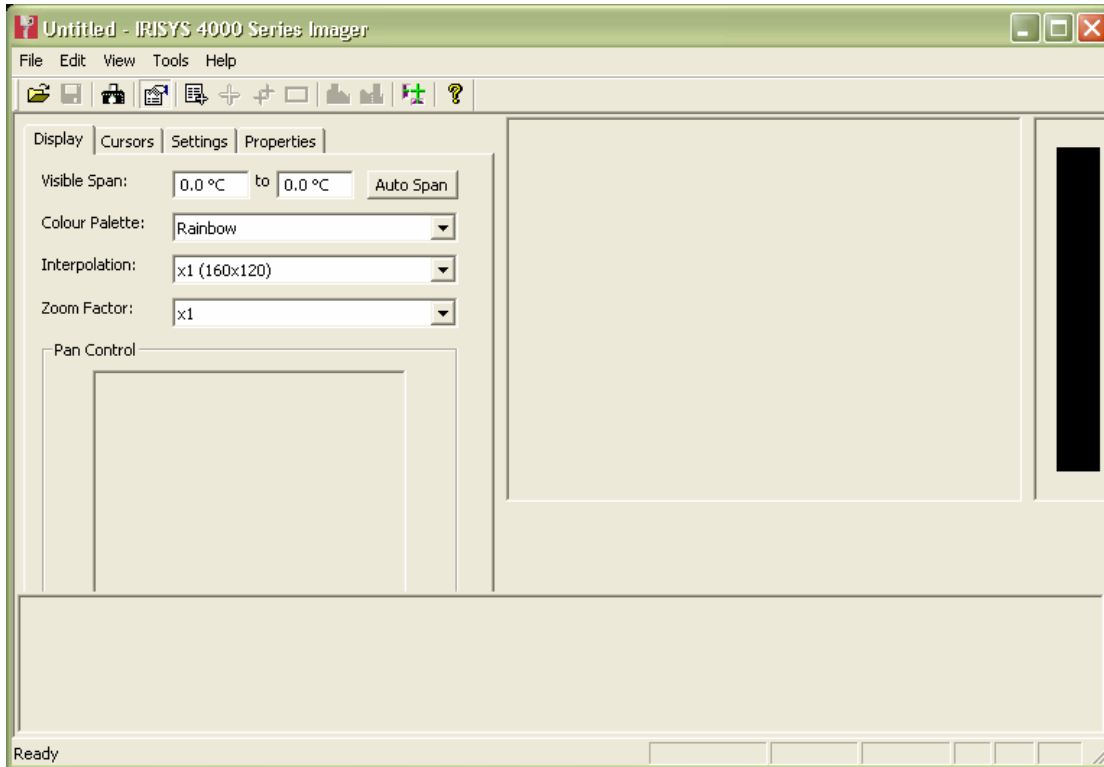

Figure 26: Application Window

5.3.1 Menus and Toolbar

The menu includes familiar Windows menu items such as “File”, “Edit”, “View”, “Tools” and “Help”.

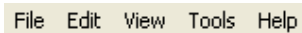

Figure 27: The Menu

5.3.1.1 Menus

5.3.1.1.1 File

The **File** menu contains the following features:

- Open
- Save
- Save As...
- Revert
- Excel Output...
- Recent Files
- Exit

1) Open - Uses Windows Explorer (see Figure 28) to open an iri file from your computer.

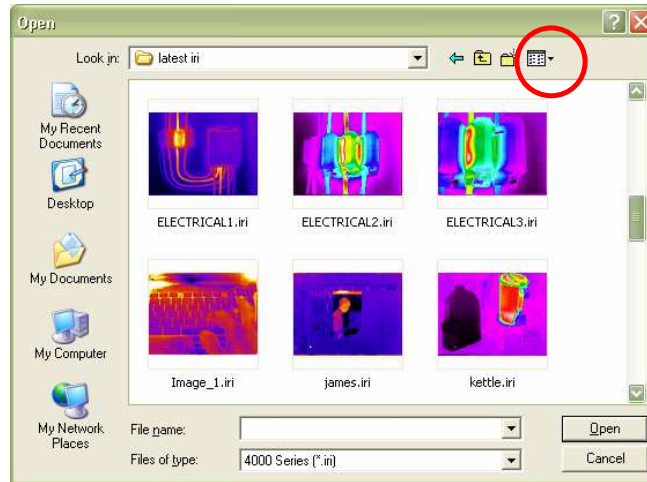

Figure 28: Windows Explorer

The iri files can be previewed in any of the five Windows explorer views: thumbnail, tile, icon, list or details, by selecting the “View” button in Windows explorer (shown in Figures 28 and 29).

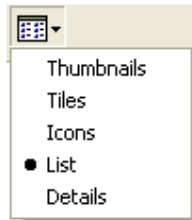

Figure 29: View Selector

After an image has been opened, the application window looks similar to figure 30 below. The four main components of the application window are the options window, the image, the colour bar and the thermal histogram. Overlaid on the histogram is the movable span selector which adjusts the level and span of the thermal image. The span selector can be moved by clicking in the middle of the histogram and dragging left or right. The span can be increased and decreased by clicking towards the ends of the span selector (where the max and min values of the span are displayed) and dragging left or right. The span can be automatically reset by double-clicking in the middle of the span selector.

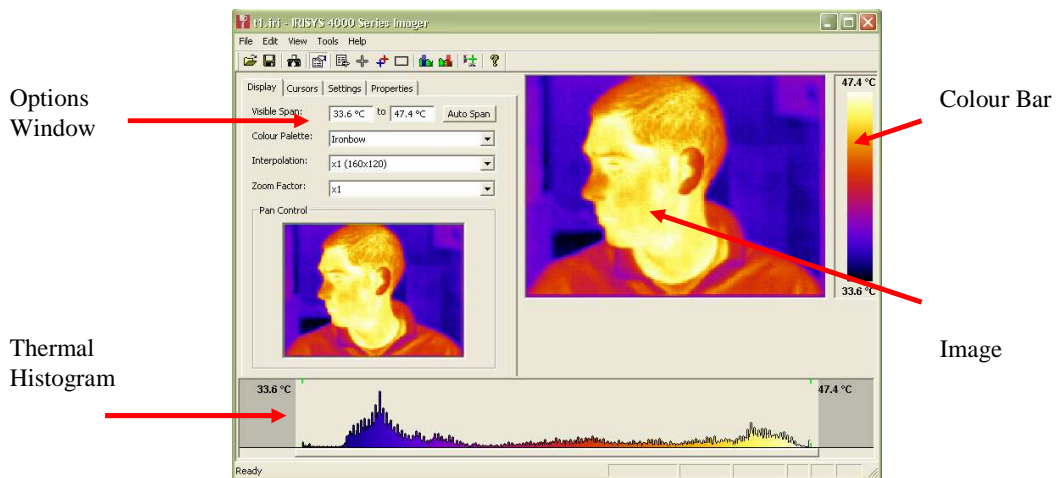

Figure 30: Application Window

- 2) Save – saves the iri file with the same name it had previously. If it was previously unsaved, the Save As... window appears.
- 3) Save As... – images are saved using a similar window to the “Open” window in Figure 28, but a file name must be entered.
- 4) Revert – restores an image file back to its last saved state.
- 5) Excel Output... - save a 160 x 120 array of temperature data (assuming emissivity = 1) in comma separated variable format for use with Microsoft Excel and other spreadsheet applications.
- 6) Recent Files – a list of recently opened iri files appears here for easy selection.
- 7) Exit – closes the IRISYS 4000 Series Imager application.

5.3.1.1.2 Edit

The **Edit** menu contains the following features:

- Copy
- Copy to Bitmap

- 1) Copy - This copies a screen capture of the application window or the thermal image into the Windows clipboard. This picture can then be pasted into a picture editor or Microsoft office document.
- 2) Copy to Bitmap – This saves a screen capture of the application window or the thermal image as a bitmap image using a dialogue box similar to Figure 28 above.

5.3.1.1.3 View

The **View** menu enables the following features, most of which are also available on the toolbar:

- Toolbar
- Status Bar
- Measurement Cursor List
- Measurement Cursors
- Hot & Cold Cursors
- Area Select
- Blue Isotherm
- Red Isotherm
- Profiles
- Options

- 1) Toolbar – This toggles the display of the icon toolbar below.

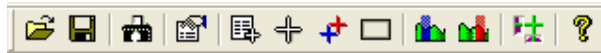



Figure 31: Toolbar

- 2) Status Bar – This toggles the display of the status bar, which includes the temperature value and pixel position of the pixel under the mouse cursor when the mouse is over the image. It also displays the difference between the midpoints of the isotherms if both the isotherms are enabled.



Figure 32: Status Bar

- 3).  Measurement Cursor List - This toggles the display of the measurement cursors list shown in Figure 33, which includes the spot measurement, pixel position, and the difference between measurement cursors 1 and 2. It also displays the hottest and coldest measurements in the scene, their difference, and the average temperature for the image. Also shown are the maximum, minimum and average temperatures for the area analysis box (if selected in the view menu).

Measurement Cursors		
ID	Temp	Pos
Cursor 1	44.5 °C	(64,95)
Cursor 2	46.0 °C	(78,57)
Cursor 3	0.0 °C	(0,0)
Cursor 4	0.0 °C	(0,0)
Cursor 5	0.0 °C	(0,0)
Cursor 6	0.0 °C	(0,0)
Cursor 7	0.0 °C	(0,0)
Cursor 8	0.0 °C	(0,0)
Cursor 9	0.0 °C	(0,0)
Cursor 10	0.0 °C	(0,0)
Temp Diff	-1.5 °C	(C1-C2)
Image Info		
Hot	47.4 °C	(64,78)
Cold	33.7 °C	(24,30)
Temp Diff	13.7 °C	(H-C)
Average	40.0 °C	
Area Select		
Max	47.4 °C	
Min	35.0 °C	
Average	44.0 °C	

Figure 33: Measurement Cursor List

Measurement cursors are added to the image by double-clicking in the location that the cursor is required. When the mouse cursor is moved over a measurement cursor the mouse cursor appears as a hand. When this happens the measurement cursors can be moved around by dragging them, and can be removed by double clicking them.

- 4).  Measurement Cursors – This toggles the display of the measurement cursors on the thermal image. This does not delete the cursors; it temporarily hides them.



Figure 34: A Measurement Cursor



- 5).  Hot & Cold Spot Cursors – This toggles cursors over the hottest and coldest measurements in the thermal image. The values of these (and the difference) are shown in the measurement cursors list.



Figure 35: Hotspot Cursor

- 6)  Area Select – This toggles a rectangular area over the centre of the image. The maximum, minimum and average temperatures for this area are then displayed in the measurement cursors list, allowing measurement by area analysis. The area’s position can be moved in conjunction with the zoom & pan control (see Figure 36). For more information on the zoom & pan control see Figure 40.

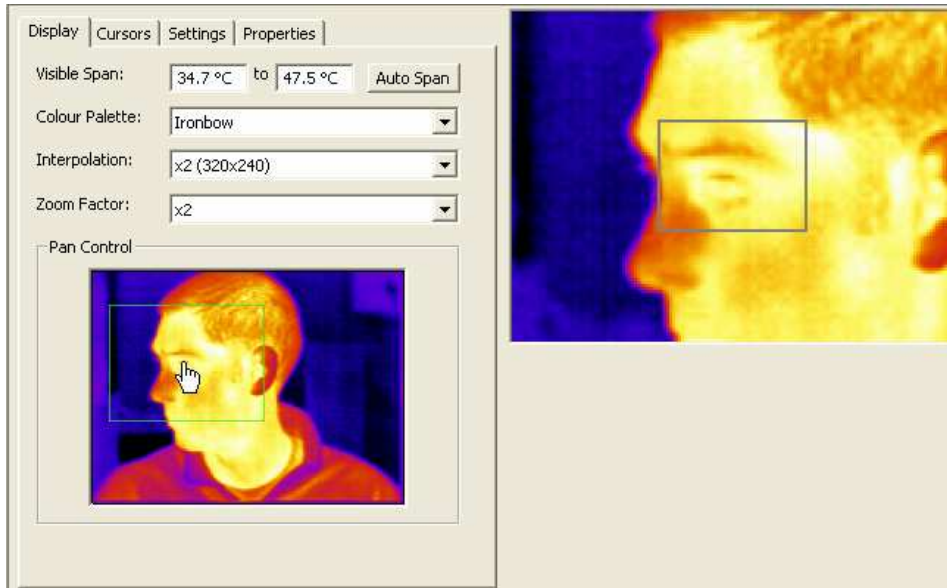



Figure 36: Area Select

- 7 & 8)  Isotherms – This toggles the two isotherms which can be used to highlight areas of the same temperature in the image. A red and/or blue semi transparent block appears on the histogram which can be moved and adjusted in the same way as the image span selector. Every object in the image with a temperature within the range of the isotherms appears either red or blue in the image. Use of the greyscale colour palette is recommended whilst using the isotherms.

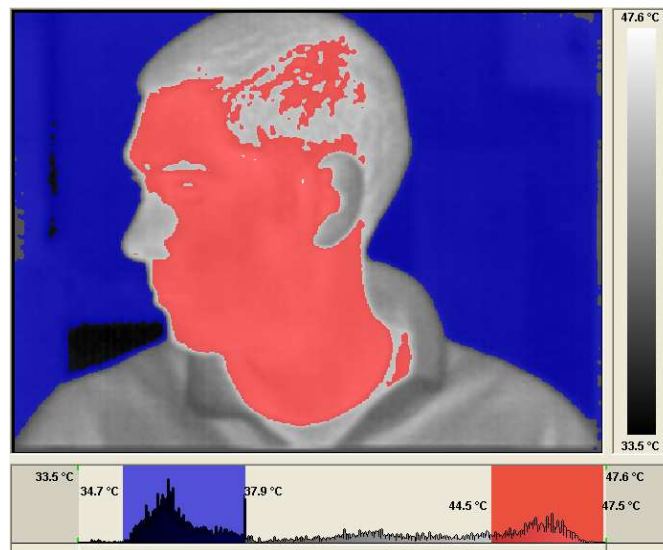



Figure 37: Dual Isotherms

- 9)  Profiles – This toggles the 2D profile view which is used to display a graphical representation of the temperature values along the selected vertical and horizontal lines.

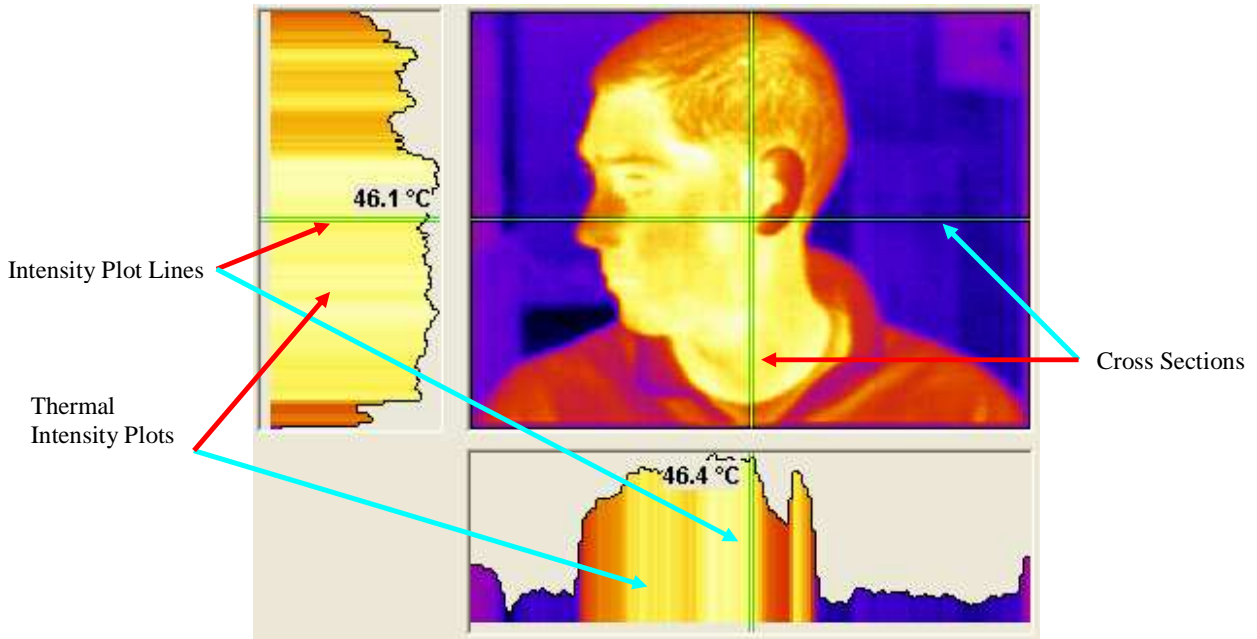



Figure 38: 2D Profiles

To the left of the image is a thermal intensity plot which corresponds to the vertical cross section through the image. Below the image is a similar plot that corresponds to the horizontal cross section. The cross sections can be moved by dragging them either independently or by dragging the intersection. The short green intensity plot lines on the thermal intensity plots can be moved to analyse temperatures in the plots. Double-click an intensity plot line to make the corresponding cross section line-up with it.

- 10)  Options – This toggles the display of the options window. The options window has four tabs across the top and it can be embedded in the application window or in a free-floating window, depending on whether or not “Dock Options” is ticked in the “Tools” menu. Click the tab labels to select each tab.

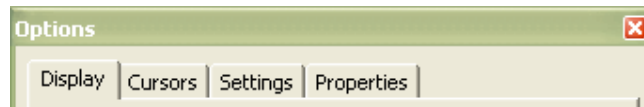

Figure 39: Options Tab Labels

The Display tab is shown below:

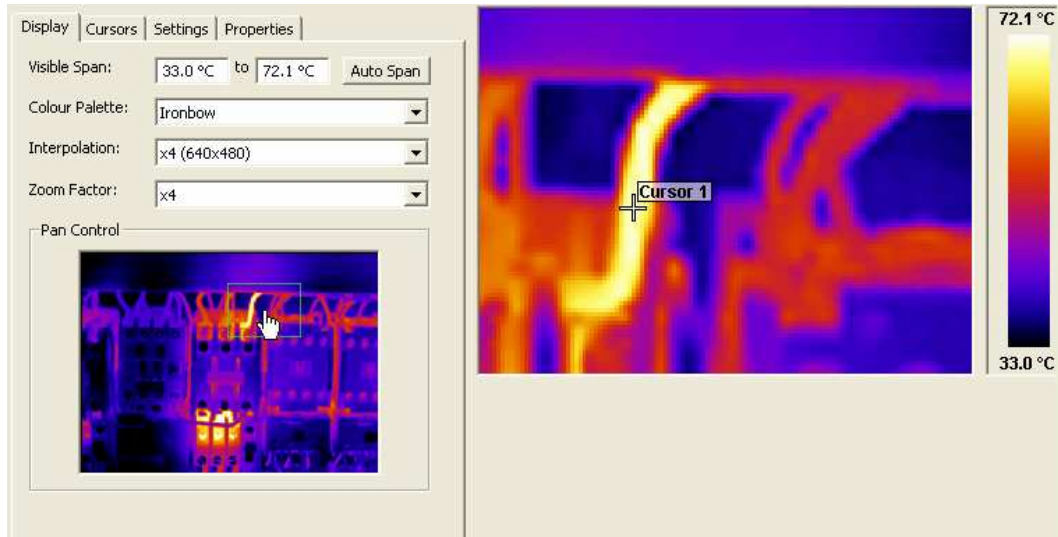

Figure 40: Display Tab

In the Display tab, it is possible to:

- Adjust the span of the image manually (by typing)
- Adjust the span of the image automatically
- Select one of four colour palettes
- Select whether to display the image at its original resolution or to interpolate the image to 320 x 240 or 640 x 480
- Select zoom factor from x1 to x4
- Select which area of the image to zoom by dragging the green box in the pan control using a mouse

The Cursors tab is shown below:

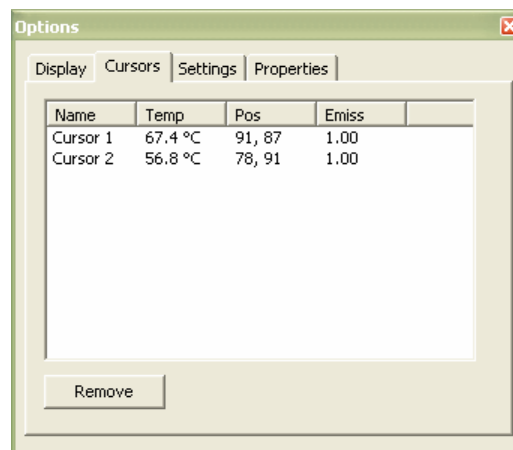

Figure 41: Cursors Tab

In the Cursors tab, it is possible to:

- View the temperature values of the measurement cursors, and also their pixel numbers from the origin (bottom left of image) and the emissivity value associated with the cursors.
- Delete cursors from the image by selecting them in the “name” column and clicking “remove”. Multiple cursors can be removed simultaneously by using the standard Windows selection methods with the Ctrl or Shift buttons.

The Settings tab is shown below:

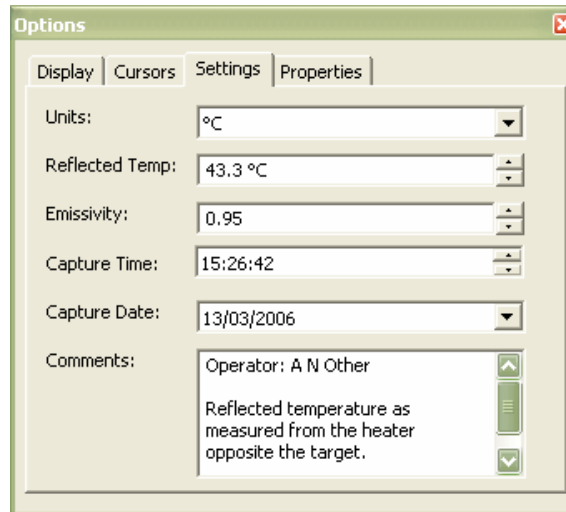

Figure 42: Settings Tab

In the Settings tab, it is possible to:

- Select °C, °F or K
- Adjust the reflected temperature correction
- Adjust the target object emissivity
- Adjust the required capture time and date
- Add comments to the image

The Properties tab is shown below:

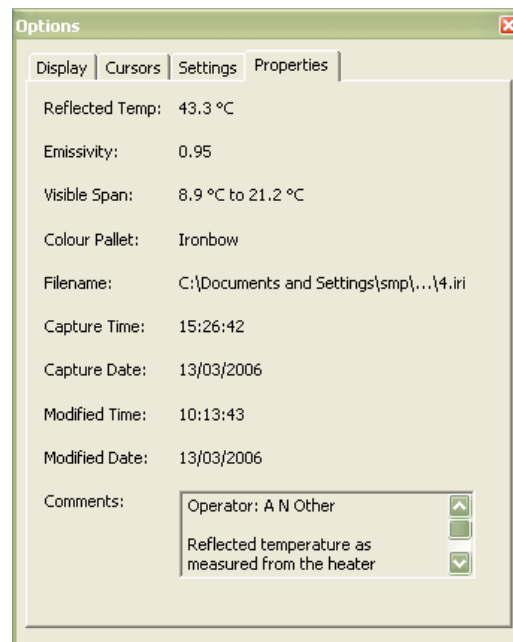



Figure 43: Properties Tab

This tab displays important file information.

5.3.1.1.4 Tools

The **Tools** menu contains the following:

- Imager Comms Config...
- Capture From Imager...
- Reset Isotherms
- Dock Options...

1)  Imager Comms Config... - This is used to transfer single images taken from the live image in the IRI 4010 to a PC via a USB connection. The first time the imager is connected to a PC via USB, the USB drivers must be installed to the PC from the CD.

1. Switch imager on
2. connect USB cable to imager
3. connect USB cable to PC
4. the Windows XP/2000 “found new hardware wizard” will appear
5. direct the wizard to the “USB Virtual Com Port” folder on the CD, and click “next”

You may have to repeat parts 4 and 5 to install the second part of the 2-part USB driver. Once the drivers have been installed, select Imager Comms Config to open the window in Figure 44 below. Select the “USB Serial Port (COM X)” from the list, click “Test Port” and then click “OK”.

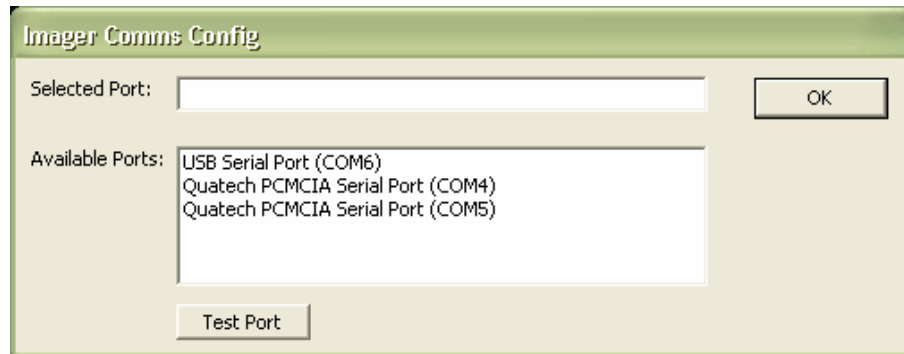



Figure 44: Port Selection

2)  Capture from imager... - After setting up the Imager Comms Config, select this to take a new image from the imager. The IRI 4010 imager must be switched on and connected via the USB cable provided to a USB port on your computer. The file transfer takes approximately 10 seconds. As always when taking an image, make sure the imager is correctly focused on the target.

3) Reset Isotherms – This moves the two isotherms back to their default positions. The isotherms must be displayed to see the effect of this tool.

4) Dock Options – This selects whether to dock the Options dialog box into the application window or whether to have the Options in a free-floating window of its own. If the Options box is not displayed, this menu item will be disabled.

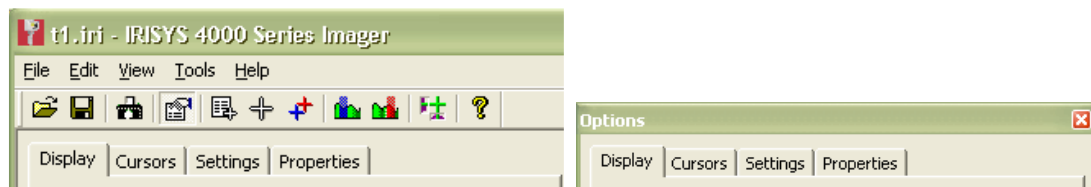

Figure 45: Options Docked and Free-Floating

5.3.1.1.5 Help

The **Help** menu gives the following information:

- About

1) About IRISYS 4000 Series Imager – This displays the IRISYS software version being used.



Figure 46: Version Information

5.3.1.2 Toolbar

The Toolbar includes 12 icons; all of which have been covered in the menus. The icons are listed below.

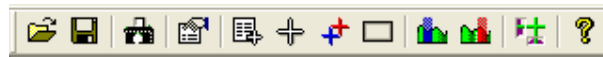

Figure 47: Toolbar

- | | | |
|-----------------------------------|---|-----------------------|
| 1) Open | - | See Section 5.3.1.1.1 |
| 2) Save | - | See Section 5.3.1.1.1 |
| 3) Capture from Imager | - | See Section 5.3.1.1.4 |
| 4) View Options | - | See Section 5.3.1.1.3 |
| 5) Toggle Measurement Cursor list | - | See Section 5.3.1.1.3 |
| 6) Toggle Measurement Cursors | - | See Section 5.3.1.1.3 |
| 7) Toggle Hot & Cold Cursors | - | See Section 5.3.1.1.3 |
| 8) Toggle Area Select | - | See Section 5.3.1.1.3 |
| 9) Toggle Blue Isotherm | - | See Section 5.3.1.1.3 |
| 10) Toggle Red Isotherm | - | See Section 5.3.1.1.3 |
| 11) Toggle Profile Display | - | See Section 5.3.1.1.3 |
| 12) About | - | See Section 5.3.1.1.5 |

6 Emissivity Lookup Table

Below is a list of approximate emissivity values for a range of materials for making more accurate temperature measurements.

NOTE: Emissivity values often vary with temperature and wavelength so this table is included as a guide only.

1.000000 = Black body	0.790000 = Steel oxidised
0.980000 = Carbon filed surface	0.780000 = Copper heavily oxidised
0.980000 = Frost crystals	0.770000 = Cotton cloth
0.980000 = Skin human	0.760000 = Sand
0.970000 = Slate	0.750000 = Unglazed silica
0.960000 = Water distilled	0.740000 = Oxidised iron at 100°C
0.960000 = Ice smooth	0.730000 = Coating No. C20A
0.950000 = Soil saturated with water	0.720000 = Basalt
0.950000 = Carbon candle soot	0.710000 = Graphitised carbon at 500°C
0.940000 = Glass polished plate	0.700000 = Red Rust
0.940000 = Paint, oil	0.690000 = Iron sheet heavily rusted
0.930000 = Brick red	0.670000 = Water
0.930000 = Paper white bond	0.660000 = Black Loam
0.920000 = Concrete	0.650000 = White cement
0.920000 = Soil dry	0.640000 = Iron cast oxidised
0.910000 = Plaster rough coat	0.630000 = Lead oxidised at 1100°F
0.900000 = Wood planed oak	0.620000 = Zirconia on inconel
0.900000 = Glazed earthenware	0.610000 = Cu-Zn, brass oxidised
0.890000 = Snow, granular	0.580000 = Inconel sheet at 760°C
0.880000 = Glazed Silica	0.560000 = Smooth white marble
0.870000 = Cuprous Oxide at 38°C	0.550000 = Al anodised chromic acid
0.860000 = Emery Corundum	0.210000 = Iron cast polished
0.850000 = Snow	0.200000 = Brass rubbed 80 grit emery
0.850000 = Stainless oxidized at 800°C	0.160000 = Stainless steel 18-8 buffed
0.840000 = Oxidised Iron at 500°C	0.090000 = Aluminium as received
0.830000 = Cuprous Oxide at 260°C	0.070000 = Steel polished
0.820000 = Snow, fine particles	0.050000 = Aluminium polished sheet
0.810000 = Brass, unoxidised	0.050000 = Copper polished
0.800000 = Glass, convex D	0.030000 = Brass highly polished

7 Customer Feedback

If you have had any technical issues or feedback with regard to your IRI 4010 Multi-Purpose Thermal Imager, please complete the details below and send it back to IRISYS at the address on the front page of this manual.

Name:

Company Name and address:

Contact Details:

IRI 4010 Thermal Imager Serial Number:

(This can be found printed under the “slots & sockets” cover)

PC Software Version installed:

Software version number can be found whilst software is running from:

PC – Help/About IRISYS 4000 Series Imager

Description of Technical Fault:

All brands and product names are acknowledged and may be trademarks or registered trademarks of their respective holders.