

# Model 311Plus Diagnostic RTD & Milliamp Calibrator Operating Instructions

## • Two Calibrators in One!

Calibrate all your RTD instruments AND your milliamp loops with the PIE 311Plus. It has all the functions of a 12 type RTD calibrator and can source 0 to 24 milliamps or simulate a two wire transmitter like a milliamp calibrator. You may also perform stand alone calibrations of two wire transmitters by simultaneously supplying the RTD input signal while supplying the 24 volts to power up the transmitter and monitoring the milliamp output signal. Powers HART™ transmitters with built-in 250 ohm resistor simplifying hookups with HART communicators.

## • Troubleshoot loop problems

Quickly diagnose ground fault and current leakage with the patented loop diagnostic technology (US Patent 7,248,058).

## • Troubleshoot RTD sensors

Troubleshoot sensor connections and find broken wires with patented technology. Connect your two, three or four wire RTDs and the PIE 311Plus automatically detects the connections. Secondary display shows the resistance value corresponding to the RTD temperature.

## • Easy to use in the shop, plant, or field

With the PIE 311Plus you can check & calibrate all your RTD instruments, measure RTD Sensors, and calibrate 4 to 20 milliamp instruments. Automatic indication of connections on the display for simple hookups. Carry it without worry - it comes protected with a rubber boot and rugged, low profile switches. Easy to operate even in dark areas with the backlit display.

## • Calibrate directly in temperature (°C & °F)

Stop carrying around a decade box and RTD resistance tables. The PIE 311Plus works with the RTDs you use including Platinum 10, 50, 100, 200, 500 & 1000 (alpha = 3850), Pt 100 Ohm (alpha=3902, 3916, 3926), Copper 10 & 50 Ohm, and Nickel 120 Ohm. Easily set any value quickly to within 0.1° with the adjustable digital potentiometer "EZ-DIAL" plus store any three temperatures for instant recall with the EZ-CHECK™ switch. And from 0.00 to 401.00 and 0.0 to 4010.0 Ohms.

## • Checkout all your 4 to 20 mA loops & instruments

With the built-in milliamp calibrator you can check, calibrate and measure all your current signal instruments in a 4 to 20 milliamp loop. It can be used at any access point in your loop. Source & Read 0.000 to 24.000 mA, Simulate a 2 Wire Transmitter or use the PIE 311Plus to simultaneously power your 2 Wire Transmitter and measure its output while simulating the sensor input.

## • Fast calibration with automatic output stepping

Choose between 2, 3, 5, 11 and 21 steps to automatically increment the output in 100%, 50%, 25%, 10% or 5% of span. Select the step time to match your system from 5, 6, 7, 8, 9, 10, 15, 20, 25, 30 and 60 seconds.

## • Compatible with ALL process instruments

No competitor's calibrator is compatible with as many process instruments! Connect directly to the RTD inputs of smart transmitters, PLCs, DCS and multichannel recorders and verify their outputs or displays. Works with older instruments with fixed excitation currents and newer multichannel instruments that switch the excitation current between input channels.



Practical Instrument Electronics

82 East Main Street Suite 3.14 • Webster, NY 14580 Tel: 585.872.9350 • Fax: 585.872.2638 • sales@piecal.com • www.piecal.com



**Magnetic Hanging Strap  
(Optional)**



**Deluxe Hands Free  
Carrying Case (Included)**



**Evolution RTD Test  
Leads (Included)**

**Practical Instrument Electronics**

## Basic Operation

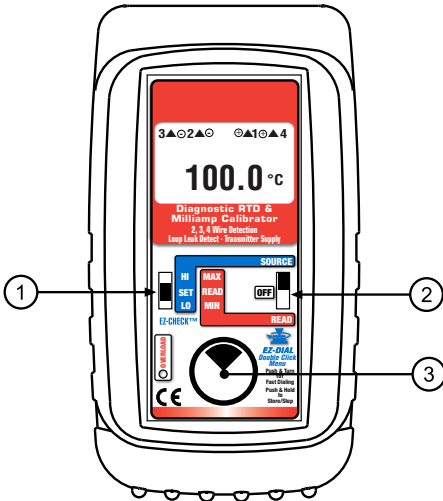

### ① EZ-CHECK™ SWITCH

**SOURCE:** Instantly output two preset RTD temperatures or milliamp values by moving the EZ-CHECK™ switch to the “LO” position or “HI” position. For fast three point checks select the “SET” position. The PIE 311Plus will remember the last “SET” value, even with the power off. These values can easily be changed to suit the calibration requirements. The values stored in the HI and LO positions are also used for Auto Stepping.

**READ:** Slide the switch to the SET position. The PIE 311Plus will display the current temperature from the RTD sensor or the current milliamp value. Slide the switch to HI and the highest value measured since turn-on or reset will be displayed; slide the switch to LO and the lowest value measured since turn-on or reset will be displayed.

### ② SOURCE/OFF/READ Switch

Select “SOURCE” to output in °C, °F, Ohms or milliamps.

Select “READ” to read a RTD sensor, Ohms or milliamps. Select “OFF” to turn the unit off.

### ③ EZ-DIAL™ KNOB

**SOURCE:** Turn the knob to adjust the output level. Turn clockwise to increase the output, counter clockwise to decrease the output in 0.1°, 0.01 Ω or 0.001 mA steps at a time. Push down and turn the EZ-DIAL knob for faster dialing.

Press and hold the knob for two seconds to store desired EZ-Check™ HI/LO points in SOURCE mode. Continue to press and hold the knob for three more seconds to start the automatic stepping or ramping.

**READ:** Press and hold the knob for two seconds to transfer the current measured value into the EZ-Check™ HI/LO points. This clears the HI/LO readings which will update as the measured value changes.

Double click the knob to get into the PIE 311Plus Configuration Mode.

### CHANGING BATTERIES

Low battery is indicated by a battery symbol on the display. Approximately one hour of typical operation remain after the first time the low battery symbol appears. To change the batteries; remove the rubber boot, remove the battery door from the back of the unit by sliding the door downward. This allows access to the battery compartment. Replace with four (4) “AA” 1.5V batteries being careful to check the polarity. Replace the battery door and the boot. All stored configuration options (T/C Type, EZ-CHECK Memories, etc..) are reset to factory settings when the batteries are removed.

**Note:** Alkaline batteries are supplied and recommended. Purchase the optional Ni-MH rechargeable batteries for maximum battery life.

# Configuration

## Double Click Menus - MAIN Page

Move ② POWER SWITCH to "SOURCE" or "READ".

**DOUBLE CLICK  
EZ-DIAL KNOB  
FOR CONFIGURATION**

V#.#

Double click the EZ-DIAL knob to access the Double Click Menus. Shown are the **MAIN** menus for each function. Turn the knob to scroll thru the menus and press the knob to select. Available choices are shown in grey.

### Source RTDs

**MAIN**

>EXIT (1/3)  
FUNCTION RTD  
UNITS °C °F  
RTD Pt 100 α=3850 [\*See Read RTD]

### Read RTDs

**MAIN**

>EXIT (1/3)  
FUNCTION RTD  
UNITS °C °F  
RTD Pt 100 α=3850, Pt 200 α=3850,  
Pt 500 α=3850, Pt 1000 α=3850,  
Pt 100 α=3902, Pt 100 α=3916,  
Pt 100 α=3926,  
Cu 10 α=4274, Cu 50 α=4280,  
Ni 120 α=6720  
Pt 10 α=3850, Pt 50 α=3850

### Source & Read Ohms

**MAIN**

> EXIT (1/3)  
FUNCTION OHMS RTD mA  
RANGE 400 Ω 4000 Ω

### Source mA & Simulate 2 Wire Transmitters

**MAIN**

> EXIT (1/2)  
FUNCTION mA  
MODE SOURCE 2W SIM  
UNITS mA %  
HART 250Ω ON OFF

## Read mA, Power/Measure Transmitters & Leak Detect

### MAIN

> EXIT (1/3)  
FUNCTION mA  
MODE READ PWR MEAS  
UNITS mA %  
HART 250Ω ON OFF

Turn the ③ DIAL KNOB to move through the two to four pages of menus. Press the ③ DIAL KNOB to toggle between **OFF** and **ON** or to scroll through the settings.

## Double Click Menu - RTD DISPLAY

**RTD DISPLAY (SOURCE)**

> EXIT (2/4)  
DISPLAY OHMS OFF ON  
SENSOR mA\* OFF ON

**RTD DISPLAY (READ)**

> EXIT (2/3)  
DISPLAY OHMS OFF ON

**DISPLAY OHMS** - If DISPLAY OHMS is ON the Ohms value corresponding to the sourced or measured temperature is displayed.

**SENSOR mA** - If SENSOR mA is ON the excitation current supplied from the RTD measuring instrument is displayed (SOURCE only).

## Double Click Menu - OHMS DISPLAY

**OHMS DISPLAY**

> EXIT (2/4)  
SENSOR mA\* OFF ON

**SENSOR mA** - If SENSOR mA is ON the excitation current supplied from the resistance measuring instrument is displayed (SOURCE only).

# Configuration

## Double Click Menu - mA DISPLAY

### mA DISPLAY (For RTD)

> EXIT (3/4)  
MODE OFF READ PWRM READ% PWRM%  
HART 250Ω ON OFF  
LEAK DETECT OFF ON

**MODE** - pressing the knob will cycle through **READ**, **PWRM**, **READ%**, **PWRM%** and **OFF**.

**READ** turns on the mA display and indicates current passing through the loop proportional to the input of the transmitter which is controlled by the output of the 311Plus. Choose **READ%** to display in percent of 4-20 milliamps.

**PWRM** is POWER MEASURE which uses the internal loop supply of the 311Plus to power up the transmitter while indicating the current passing through the loop proportional to the input of transmitter which is controlled by the output of the 311Plus. Choose **PWRM%** to display in percent of 4-20 milliamps.

If **PWRM** or **PWRM%** is selected an additional menu selection of **LEAK DETECT** will appear. When **LEAK DETECT** is turned on the 311Plus will display **LEAK** and the amount of current that is uncontrolled in the loop. This may be due to a faulty transmitter, corrosion causing a bridge to ground or moisture present at some connection point. When **LEAK DETECT** tests a loop with leakage the loop mA signal will be affected.

**HART 250Ω** - turn on the 250Ω resistor if you are powering up a HART transmitter. This provides the loop load required for HART communication.

## Double Click Menu - FEATURES

### FEATURES

> EXIT (4/4)  
AUTO OFF ON OFF  
BACKLIGHT ON OFF  
STEPS/RAMP 2 3 5 11 RAMP  
STEP/RAMP TIME 5 6 7 8 9 10 15 20 25 30 60

**AUTO OFF** - If **AUTO OFF** is **ON**, the unit will turn off after 30 minutes of inactivity to save battery life. If **AUTO OFF** is **OFF** the unit will stay on until the POWER SWITCH is moved to the off position.

**BACKLIGHT** - If **BACKLIGHT** is **ON** the backlight will light all the time the unit is powered up. For maximum battery life turn the backlight off when using the calibrator in areas with enough ambient light to read the display.

**STEPS/RAMP** - pressing the knob will cycle through **2**, **3**, **5**, **11** and **RAMP**. The endpoints of the steps or ramp are based on the values stored in the **HI** and **LO** EZ-CHECK outputs.

**2 steps** will automatically switch between the values stored in the HI & LO EZ-CHECK (0 & 100%).

**3 steps** between the HI, Midpoint and LO EZ-CHECK (0, 50 & 100%).

**5 steps** between the HI and LO EZ-CHECK in 25% increments (0, 25, 50, 75 & 100%).

**11 steps** between the HI and LO EZ-CHECK in 10% increments (0, 10, 20..80, 90 & 100%).

**RAMP** continuously ramps up and down between the HI and LO EZ-CHECK outputs.

**STEP/RAMP TIME** - pressing the knob will cycle through **5**, **6**, **7**, **8**, **9**, **10**, **15**, **20**, **25**, **30** and **60** seconds.

## Storing EZ-CHECK Outputs

### STORING HI and LO EZ-CHECK Outputs

Choose this function to provide a simulated RTD signal into controllers, temperature transmitters, indicators or any other input device that measure RTD sensors.

- 1) Store your high (SPAN) output temperature by moving the EZ-CHECK switch to the **HI** position and turn the ③ EZ-Dial knob until the desired temperature is on the display. Press and hold the EZ-Dial knob until **STORED** appears to store the value. Release the EZ-Dial knob.
- 2) Store your low (ZERO) output temperature by moving the EZ-CHECK switch to the **LO** position and turn the ③ EZ-Dial knob until the desired temperature is on the display. Press and hold the EZ-Dial knob until **STORED** appears to store the value. Release the EZ-Dial knob.
- 3) Instantly output your SPAN and ZERO temperature outputs by moving the EZ-CHECK switch between HI and LO. You may also select any third temperature output (such as mid-range) using the SET position on the EZ-CHECK switch.

## Automatic Stepping

### To change the Automatic Stepping settings

Double click the ③ DIAL KNOB at any time the unit is on and the menu will appear for 15 seconds.

Turn the ③ DIAL KNOB to move through down to the third (FEATURES) menu. Press the ③ DIAL KNOB to toggle between OFF and ON or to change the STEPS and the STEP TIME settings. These settings are remembered even with the power off.

FEATURES	
> EXIT (3/3)	
AUTO OFF	ON OFF
BACKLIGHT	ON OFF
STEPS/RAMP	2 3 5 11 RAMP
STEP/RAMP TIME	5 6 7 8 9 10 15 20 25 30 60

**EXIT MENU** - exits this menu immediately and saves any changes. Menu will automatically exit after 15 seconds of inactivity.

**STEPS** - pressing the knob will cycle through 2, 3, 5 and 11 then reverse direction. The endpoints of the steps are based on the values stored in the **HI** and **LO** EZ-CHECK outputs.

**2 steps** will automatically switch between the values stored in the HI & LO EZ-CHECK (0 & 100%).

**3 steps** between the HI, Midpoint and LO EZ-CHECK (0, 50 & 100%).

**5 steps** between the HI and LO EZ-CHECK in 25% increments (0, 25, 50, 75 & 100%).

**11 steps** between the HI and LO EZ-CHECK in 10% increments (0, 10, 20...80, 90 & 100%).

**RAMP** continuously between the HI and LO EZ-CHECK.

**STEP TIME** - pressing the knob will cycle through 5, 6, 7, 8, 9, 10, 15, 20, 25, 30 and 60 seconds.

### To start the Automatic Stepping

Start automatic stepping or ramping by placing the EZ-CHECK Switch into the HI or LO position then press and hold the ③ DIAL KNOB for 6 seconds (the word STORE will appear on the display after 3 seconds and continue to press the DIAL KNOB) until the word STEPPING appears on the display. The word STEPPING will appear on the display anytime the selected automatic function is running. Stop the stepping by again pressing and holding the ③ DIAL KNOB for 3 seconds.

## Practical Instrument Electronics

## Connections

The PIE 311Plus has four standard banana jacks for 2, 3 or 4 wire instruments or sensors. All connections are made at the top of the calibrator where the jacks are numbered for ease of use.

**SOURCE** - Plug in the 2, 3 or 4 wires to match the connection on the instrument being calibrated.

**READ** - Plug in the 2, 3 or 4 wires from the sensor and the PIE 311Plus will automatically detect the correct setting for 2, 3 or 4 wire simulation using a patented circuit.

**Milliamp** - All milliamp connections are connected to the banana jacks labeled 5 (+) and 6 (-).

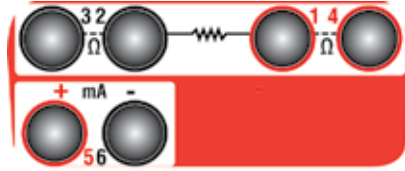

### Problem found with RTD Sensor Wiring

Here is an example of the PIE 311Plus reading a sensor with all 4 wires connected.



Here is an example where connections are made to a 4 wire sensor and the 311Plus indicates that only Wires 1, 2 & 4 are connected. There may be a loose connection or a break in wire 3 somewhere between the sensor and the 311Plus.



Only a calibrator with PIE's patented 2, 3 & 4 wire detection makes troubleshooting sensor wiring quick, easy and automatic. This is much simpler and faster than going through the process of testing each pair of wires to figure out which, if any, connection is loose or which wire is broken.



# Troubleshooting RTD Instruments

## Troubleshooting RTD Instruments

When you are having an issue where an instrument won't read an RTD sensor or you don't know if the calibrator is connected properly the PIE 311Plus has a function to measure and display the fixed or pulsed sensor (excitation) current that the instrument uses to measure the resistance of the RTD sensor.

Double click the ③ DIAL KNOB at any time the unit is on and then turn the ③ DIAL KNOB to move to the second menu page so the word **DISPLAY** appears at the top of the menu. Turn the ③ DIAL KNOB to move through the menu until the cursor is pointing at **SENSOR mA**. Press the ③ DIAL KNOB to toggle **SENSOR mA ON**.

Disconnect all sensor wires from the devices to be calibrated and connect the PIE 311Plus to the inputs of the device using 2, 3 or 4 wires. The sensor current generated by the instrument will be indicated on the display followed by the word **FIXED** or **PULSE**. Older single channel RTD instruments used a constant (fixed) current source to measure an RTD sensor. Smart transmitters, multichannel recorders and PLC or DCS input cards switch the current source sequentially through the channels which is seen as an intermittent (pulsed) current.

Instrument with RTD Input  
Controller  
Temperature Transmitter  
Temperature Indicator  
Temperature Trip or Alarm

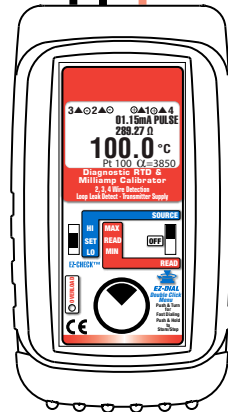

Excitation current generated  
by the RTD Instrument

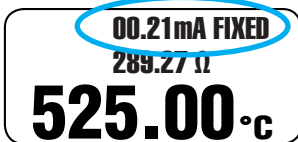

Excitation current generated  
by the RTD Instrument

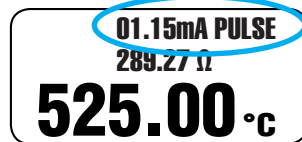

# Operating Instructions

## RTD Source

Choose this function to provide a simulated RTD signal into controllers, temperature transmitters, indicators or any input devices that measure RTD sensors.

Move the power switch ② to SOURCE then Double Click the EZ-DIAL knob to get into the menu. Turn the knob to scroll through the settings and press the knob to make your selection. Select **RTD** for the **FUNCTION**, **°F** or **°C** for the **UNITS**, and **RTD Type** (Pt 100 a=3850, Pt 200 a=3850, Pt 500 a=3850, Pt 1000 a=3850, Pt 100 a=3902, Pt 100 a=3916, Pt 100 a=3926, Cu 10 a=4274, Cu 50 a=4280, Ni 120 a=6720, Pt 10 a=3850, Pt 50 a=3850).

Connect the PIE 311Plus to the inputs of the device being calibrated 2, 3 or 4 wires.

Instantly output your SPAN and ZERO output settings by moving the EZ-CHECK switch between HI and LO. You may also select any third output setting (such as mid-range) using the SET position on the EZ-CHECK switch. The output is adjusted in 0.1° increments by turning the knob ③. Press and turn the knob for faster dialing with 10.0° increments.

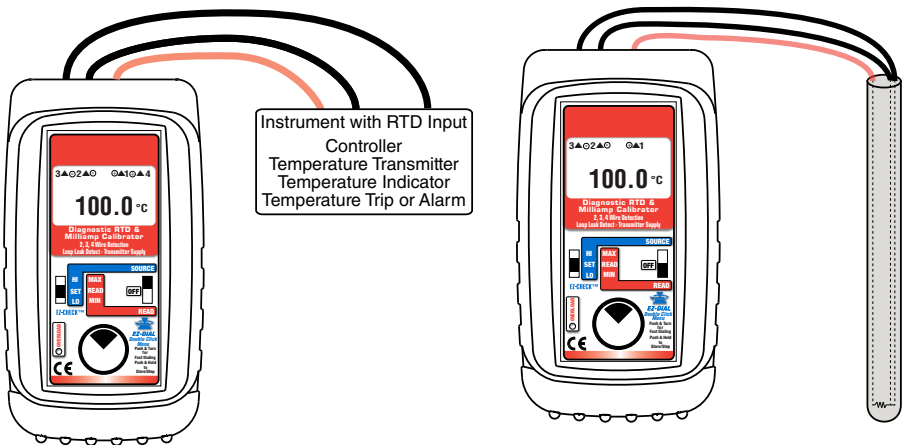

## Read RTD Sensors

Choose this function to measure temperatures with a RTD probe, sensor or any device that output a RTD signal.

Move the power switch ② to READ then Double Click the EZ-DIAL knob to get into the Double Click Menu. Turn the knob to scroll through the settings and press the knob to make your selection. Select **RTD** for the **FUNCTION**, **°F** or **°C** for the **UNITS**, and **RTD Type** (Pt 100 a=3850, Pt 200 a=3850, Pt 500 a=3850, Pt 1000 a=3850, Pt 100 a=3902, Pt 100 a=3916, Pt 100 a=3926, Cu 10 a=4274, Cu 50 a=4280, Ni 120 a=6720, Pt 10 a=3850, Pt 50 a=3850).

Connect the PIE 311Plus to the RTD sensor being measured. If no sensor is connected, a wire is broken or the sensor is burned out, CHECK CONNECTIONS will appear on the display along with an indication of which wires are connected. Signals above the maximum scale are limited by protection circuitry with "OVER RANGE" on the display and the OVERLOAD LED blinks red.

The PIE 311Plus measures the input signal and constantly updates the display with the current reading. Move the EZ-CHECK switch ① to MAX to see the highest reading and to MIN to see the lowest reading. Press and hold the knob ③ to clear the MAX and MIN readings.

## Practical Instrument Electronics

# Operating Instructions

## OHMS SOURCE

Choose this function to provide an output from 0.00 to 4010.0 ohms.

Move the power switch ② to SOURCE then Double Click the EZ-DIAL knob to get into the Menu. Turn the knob to scroll through the settings and press the knob to make your selection. Select **OHMS** for the **FUNCTION** and **400Ω** or **4000Ω** for the **RANGE**.

Connect the output leads of the PIE 311Plus to the inputs of the device being calibrated.

Instantly output your SPAN and ZERO output settings by moving the EZ-CHECK switch between HI and LO. You may also select any third output setting (such as mid-range) using the SET position on the EZ-CHECK switch. The output is adjusted in 0.01 Ω increments by turning the knob ③. Press and turn the knob for faster dialing with 1.00 Ω increments.

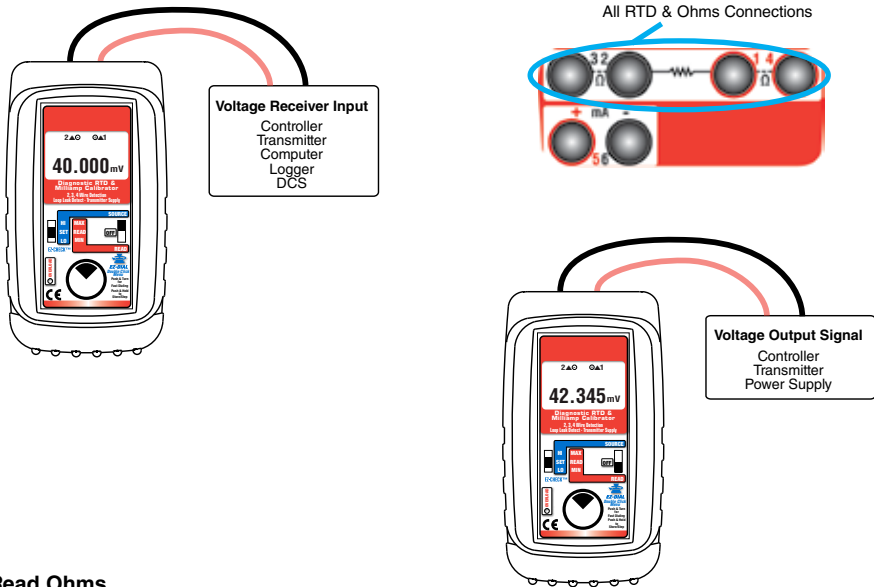

## Read Ohms

Choose this function to measure from 0.00 to 4010.0 ohms.

Move the power switch ② to READ then Double Click the EZ-DIAL knob to get into the Menu. Turn the knob to scroll through the settings and press the knob to make your selection. Select **OHMS** for the **FUNCTION** and **400Ω** or **4000Ω** for the **RANGE**.

Connect the input leads of the PIE 311Plus to the resistance being measured.

Signals above the maximum scale are limited by protection circuitry with "OVER RANGE" flashed on the display and the red OVERLOAD LED lit.

The PIE 311Plus measures the input signal and constantly updates the display with the current reading. Move the EZ-CHECK switch ① to MAX to see the highest reading and to MIN to see the lowest reading. Press and hold the knob ③ to clear the MAX and MIN readings.

# Operating Instructions

## mA SOURCE/ % SOURCE (Percent of 4 to 20 mA)

Choose this function to provide an output from 0.000 to 24.000 milliamps. The compliance voltage is a nominal 24 VDC to provide the driving power to your milliamp receivers.

Move the power switch ② to SOURCE then Double Click the EZ-DIAL knob to get into the menu. Turn the knob to scroll through the settings and press the knob to make your selection. Select **mA** for the **FUNCTION** and **SOURCE** for the **MODE**. Choose either **mA** or **%** and whether you need the 250Ω HART resistor active in the loop.

Connect the output leads of the PIE 311Plus to the inputs of the device being calibrated, making sure to check polarity. Red lead to the plus (+) input and black lead to the minus (-) input.

Instantly output your SPAN and ZERO output settings by moving the EZ-CHECK switch between HI and LO (defaults to 20 & 4 mA). You may also select any third output setting (such as mid-range) using the SET position on the EZ-CHECK switch. The output is adjusted in 0.001 mA (0.01%) increments by turning the knob ③. Press and turn the knob for faster dialing with 0.100 mA (1.00%) increments.

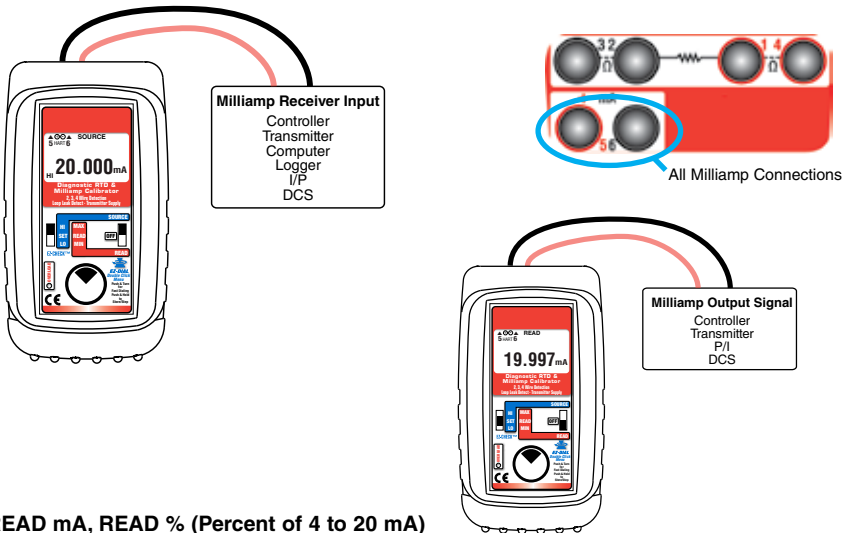

## READ mA, READ % (Percent of 4 to 20 mA)

Choose this function to measure from 0.000 to 24.000 milliamps or -25.00 to 125.00%.

Move the power switch ② to READ then Double Click the EZ-DIAL knob to get into the Menu. Turn the knob to scroll through the settings and press the knob to make your selection. Select **mA** for the **FUNCTION** and **SOURCE** for the **MODE**. Choose either **mA** or **%** and whether you need the 250Ω HART resistor active in the loop.

Connect the red input lead (+) of the PIE 311Plus to the more positive point of the break and the black input to the more negative point.

Signals below 0 mA or open circuits are indicated by 0.000 mA (-25.00%) on the display. Signals above 24 mA are current limited by protection circuitry with "OVERRANGE" flashed on the display and the red OVERLOAD LED lit.

The PIE 311Plus measures the input signal and constantly updates the display with the current reading. Move the EZ-CHECK switch ① to MAX to see the highest reading and to MIN to see the lowest reading. Press and hold the knob ③ to clear the MAX and MIN readings.

## Practical Instrument Electronics

# Operating Instructions

## Power/Measure mA, Power/Measure % (Percent of 4 to 20 mA)

Choose this function to simultaneously supply power to a 2 Wire Transmitter while displaying the 4.000 to 20.000 mA output of the transmitter.

Move the power switch ② to READ then Double Click the EZ-DIAL knob to get into the menu. Turn the knob ③ to scroll through the settings and press the knob to make your selection. Select **mA** for the **FUNCTION** and **PWR MEAS** for the **MODE**. Choose either **mA** or **%** and whether you need the 250Ω HART resistor active in the loop.

Disconnect one or both input wires from the device to be calibrated. Connect the red source lead of the PIE 311Plus to the plus (+) input of the device and the black source lead to the minus (-).

The PIE 311Plus supplies a nominal 24 volts DC at 24 mA to the 2 Wire Transmitter. The current passed by the transmitter will be accurately displayed by the PIE 311Plus. Calibrate the transmitter in the usual manner and disconnect the PIE 311Plus. Signals above 24 mA are current limited by protection circuitry with "OVERRANGE" flashed on the display and the red OVERLOAD LED lit.

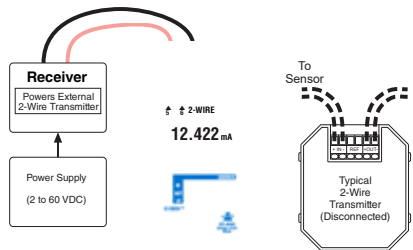
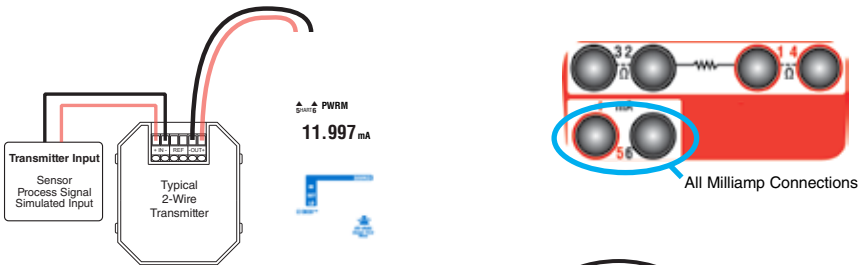

## 2 Wire SIM mA, 2 Wire SIM % (Percent of 4 to 20 mA)

Choose this function to simulate a 2 Wire Transmitter output from 0.000 to 24.000 milliamps. Operates in loops with power supply voltages from 2 to 60 VDC.

Move the power switch ② to **SOURCE** then Double Click the EZ-DIAL knob to get into the Menu. Turn the knob to scroll through the settings and press the knob to make your selection. Select **mA** for the **FUNCTION** and **2W SIM** for the **MODE**. Choose either **mA** or **%** and whether you need the 250Ω HART resistor active in the loop.

Connect the output leads of the PIE 311Plus to the inputs of the device being calibrated, making sure to check polarity. Red lead to the plus (+) input and black lead to the minus (-) input.

Instantly output your SPAN and ZERO output settings by moving the EZ-CHECK switch between HI and LO (defaults to 20 & 4 mA). You may also select any third output setting (such as mid-range) using the SET position on the EZ-CHECK switch. The output is adjusted in 0.001 mA (0.01%) increments by turning the knob ③. Press and turn the knob for faster dialing with 0.100 mA (1.00%) increments.

Practical Instrument Electronics

82 East Main Street Suite 3.14 • Webster, NY 14580 Tel: 585.872.9350 • Fax: 585.872.2638 • sales@piecal.com • www.piecal.com

# Operating Instructions

Calibrate a 2-Wire RTD Transmitter by sourcing the input while monitoring the output.

Move the power switch ② to SOURCE and Double click the ③ DIAL KNOB and the MAIN menu for the function in use will appear for 15 seconds:

Turn the ③ DIAL KNOB to move to **FUNCTION**. Select **RTD** for the **FUNCTION**, **°F** or **°C** for the **UNITS**, and **RTD Type** (Pt 100  $\alpha$ =3850, Pt 200  $\alpha$ =3850, Pt 500  $\alpha$ =3850, Pt 1000  $\alpha$ =3850, Pt 100  $\alpha$ =3902, Pt 100  $\alpha$ =3916, Pt 100  $\alpha$ =3926, Cu 10  $\alpha$ =4274, Cu 50  $\alpha$ =4280, Ni 120  $\alpha$ =6720, Pt 10  $\alpha$ =3850, Pt 50  $\alpha$ =3850). Turn the ③ DIAL KNOB to move to the third menu page so the word **mA DISPLAY** appears at the top of the menu.

```

MAIN
> >EXIT (1/4)
FUNCTION RTD
UNITS °C °F
RTD Pt 100  $\alpha$ =3850, Pt 200  $\alpha$ =3850,
Pt 500  $\alpha$ =3850, Pt 1000  $\alpha$ =3850,
Pt 100  $\alpha$ =3902, Pt 100  $\alpha$ =3916,
Pt 100  $\alpha$ =3926,
Cu 10  $\alpha$ =4274, Cu 50  $\alpha$ =4280,
Ni 120  $\alpha$ =6720
Pt 10  $\alpha$ =3850, Pt 50  $\alpha$ =3850

```

Turn the ③ DIAL KNOB to move through the menu. Press the ③ DIAL KNOB to toggle between **OFF** and **ON** or to change the **MODE** setting.

```

mA DISPLAY
> EXIT (3/4)
MODE OFF READ PWRM READ% PWRM%
HART 250 $\Omega$  OFF ON
LEAK DETECT OFF ON

```

**MODE** - pressing the knob will cycle through READ, PWRM, READ% ,PWRM% and OFF.

**READ** turns on the mA display and indicates current passing through the loop proportional to the input of the transmitter which is controlled by the output of the 311Plus. Choose **READ%** if your would like the mA display in percent of 4-20 milliamps.

**PWRM** is POWER MEASURE which uses the internal loop supply of the 311Plus to power up the transmitter while indicating the current passing through the loop proportional to the input of transmitter which is controlled by the output of the 311Plus. Choose **PWRM%** if your would like the mA display in percent of 4-20 milliamps.

If **PWRM** or **PWRM%** is selected an additional menu selection of **LEAK DETECT** will appear. When **LEAK DETECT** is turned on the 311Plus will display **LEAK** and the amount of current that is uncontrolled in the loop. This may be due to a faulty transmitter, corrosion causing a bridge to ground or moisture present at some connection point. When **LEAK DETECT** tests a loop with leakage the loop mA signal will be affected.

**HART 250 $\Omega$**  - turn on the 250 $\Omega$  resistor if you are powering up a HART transmitter. This provides the loop load required for HART communication.

**EXIT MENU** - exits this menu immediately and saves any changes. Menu will automatically exit after 15 seconds of inactivity.

# Operating Instructions

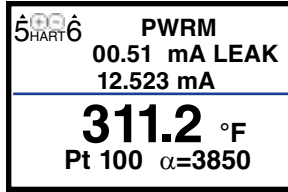

(Enlarged Display)

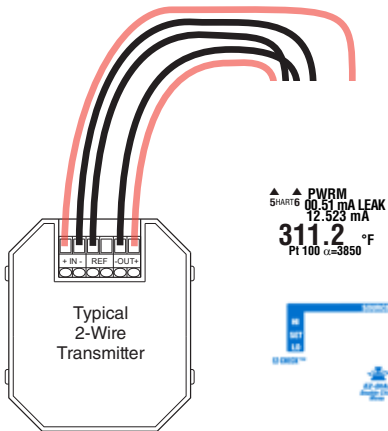

# Operating Instructions

## Using Ground Leak Detection

### mA OUT, % OUT (Percent of 4 to 20 mA)

Find current leaks in loops caused by ground faults, moisture or corrosion. The 311Plus simultaneously supplies power to a 2 Wire Transmitter (or loop with a transmitter) while displaying the 4 to 20 mA output and the amount of current leaking in the loop.

- 1) Move the power switch ② to READ then Double Click the EZ-DIAL knob to get into the Menu. Turn the knob ③ to scroll through the settings and press the knob to make your selection. Select **mA** for the **FUNCTION** and **PWR MEAS** for the **MODE**. Choose either **mA** or **%**.
- 2) Turn the knob ③ until the menu to the right appears.
- 3) Turn the knob ③ to scroll through the settings and press the knob to make your selection. Turn on the **LEAK DETECT**.
- 4) Connect the red source lead from the mA (+) jack of the 311Plus to the plus (+) input of the device and the black source lead from the mA (-) to the minus (-).

**mA DIAGNOSTIC**  
> EXIT (2/3)  
LEAK DETECT OFF ON

The PIE 311Plus supplies a nominal 24 volts DC at 24 mA to the 2 Wire Transmitter or loop. The current passed by the transmitter will be accurately displayed by the 311Plus along with an indication of leakage current at the top of the display. If there is an uncontrolled loop caused by a transmitter with upscale burnout and a sensor that is burned out or missing, or a short in the loop wiring, the 311Plus will display "OVER RANGE"

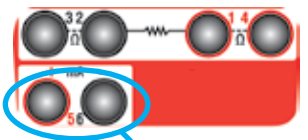
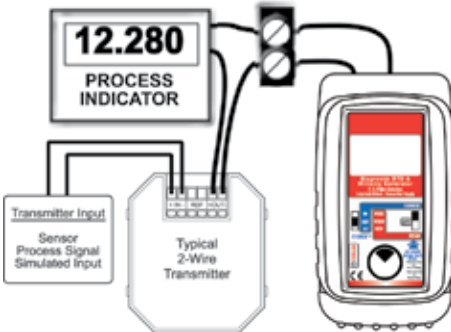

All Milliamp Connections

## Typical Error Conditions

5 HART 6 PWRM LEAK  
00.51 mA  
12.506 mA

The PIE 311Plus is supplying the loop voltage. A calibrated transmitter is limiting the loop current to 12.00 mA. An additional 0.51 mA is not controlled by the transmitter and is leaking somewhere in the loop.

5 HART 6 PWRM  
OVER RANGE  
mA

The PIE 311Plus is supplying the loop voltage. There is a control loop error. This may be a transmitter (set for upscale burnout) with a bad or missing sensor, or a short in the loop. The red ERROR LED will also flash.

**Note:** Many loops with installed transmitters will normally indicate 0.01 to 0.02 mA leakage without significant control problem. Unstable readings may indicate loose connections or the presence of moisture.

## Practical Instrument Electronics



# PIE 311 Plus Specifications

Unless otherwise indicated all specifications (except Cold Junction) are rated from a nominal 23 °C, 70 % RH for 1 year from calibration

<b>General</b>	
Operating Temperature Range	-25 to 60 °C (-10 to 140 °F)
Relative Humidity Range	10 % ≤RH ≤90 % (0 to 35 °C), Non-condensing 10 % ≤RH ≤ 70 % (35 to 60 °C), Non-condensing
Temperature Drift	± 0.01% of span outside of 23°C ±10 °C (73°C ±18 °F)
Size	5.63 x 3.00 x 1.60 in, 143 x 76 x 41 mm (L x W x H)
Weight	12.1 ounces, 0.34 kg (including boot & batteries)
Batteries	Four "AA" Alkaline 1.5V (LR6)
Battery Life	25 Hours RTD, 8 Hours milliamp
Isolation: Voltage	60V rms between all milliamp functions and Source/Read RTD/Ohms
Normal Mode Rejection	50/60 Hz, 50 dB
Common Mode Rejection	50/60 Hz, 120 dB
Optional NiMh Rechargeable battery kit	Charger, four NiMh batteries [Part # 020-0103]
Low Battery	Low battery indication with nominal 1 hour of operation left
Protection against misconnection	Over-voltage protection to 60 V dc (rated for 30 seconds)
Display	High contrast graphic liquid crystal display. LED backlighting for use in low lit areas.

<b>Source Ohms &amp; RTD</b>	
3 & 4 Wire Accuracy From 1 to 10.2 mA External Excitation Current	±(0.015% of Reading + 0.05 Ohms)
Below 1 mA of External Excitation Current	±(0.015% of R <sub>dg</sub> + $\frac{0.025 \text{ mV}}{\text{mA Excitation Current}} + 0.05 \text{ Ohms}$ )
2 Wire Accuracy	Add 0.1 Ohms to 3 Wire & 4 Wire Accuracy
Resistance Ranges	0.00 to 401.00, 0.0 to 4010.0 Ohms
Allowable Excitation Current Range	0 to 400 Ohm: 10.2 mA max; steady or pulsed/intermittent 401 to 4000 Ohms: 1 mA max; steady or pulsed/intermittent
Pulsed Excitation Current Compatibility	DC to 0.01 second pulse width

<b>Read Ohms &amp; RTD</b>	
3 Wire & 4 Wire Accuracy	±(0.015% of Reading + 0.05 Ohms)
2 Wire Accuracy	±(0.015% of Reading + 0.15 Ohms)
Resistance Ranges	0.00 to 401.00, 0.0 to 4010.0 Ohms
Excitation Current	0.9 mA to 401 Ohms, 0.4 mA to 4010 Ohms (nominal)

## Practical Instrument Electronics

82 East Main Street Suite 3.14 • Webster, NY 14580 Tel: 585.872.9350 • Fax: 585.872.2638 • sales@piecal.com • www.piecal.com

## PIE 3 I Plus Specifications

Unless otherwise indicated all specifications (except Cold Junction) are rated from a nominal 23 °C, 70 % RH for 1 year from calibration

<b>Read mA</b>	
Ranges and Resolution	0.000 to 24.000 mA or -25.00 to 125.00% of 4-20 mA
Accuracy	$\leq \pm (0.02 \% \text{ of Reading} + 0.003 \text{ mA})$
Voltage burden	$\leq 2\text{V}$ at 24 mA
Overload/Current limit protection	25 mA nominal

<b>Source mA / Power &amp; Measure Two Wire Transmitters &amp; PWRM LEAK</b>	
Ranges and Resolution	0.000 to 24.000 mA or -25.00 to 125.00% of 4-20 mA
Accuracy	$\leq \pm (0.02 \% \text{ of Reading} + 0.003 \text{ mA})$
Loop compliance voltage	$\geq 24 \text{ DCV @ } 20.00\text{mA}$
Loop drive capability	1200 $\Omega$ at 20 mA for 15 hours nominal; 950 $\Omega$ with Hart Resistor or leak detection running

<b>mA 2-Wire Transmitter Simulation</b>	
Accuracy	Same as Source/Power & Measure
Voltage burden	$\leq 2\text{V}$ at 20 mA
Overload/Current limit protection	24 mA nominal
Loop voltage limits	2 to 60 VDC (fuse-less protected from reverse polarity connections)

## RTD Ranges & Accuracies

**Table based on 3 & 4 Wire RTD Accuracy:**  
 $\leq \pm (0.015 \% \text{ of Reading} + 0.05 \text{ Ohms})$   
 [Read based on 1.0 mA of fixed excitation current]

RTD Type	Alpha	Degrees C Range	°C	Degrees F Range	°F
Pt 100 Ohm DIN/IEC/JIS 1989 ITS-90	1.3850 (0.00385)	-200.0 to -150.0 -150.0 to 360.0 360.0 to 740.0 740.0 to 850.0	$\pm 0.1^\circ$ $\pm 0.2^\circ$ $\pm 0.3^\circ$ $\pm 0.4^\circ$	-328.0 to -238.0 -238.0 to 660.0 660.0 to 1364.0 1364.0 to 1562.0	$\pm 0.2^\circ$ $\pm 0.4^\circ$ $\pm 0.6^\circ$ $\pm 0.7^\circ$
Pt 10 Ohm DIN/IEC/JIS 1989 Based on ITS-90	1.3850 (0.00385)	-200.0 to -120.0 -120.0 to 210.0 210.0 to 370.0 370.0 to 650.0 650.0 to 850.0	$\pm 1.2^\circ$ $\pm 1.4^\circ$ $\pm 1.5^\circ$ $\pm 1.7^\circ$ $\pm 1.9^\circ$	-328.0 to -184.0 -184.0 to 410.0 410.0 to 698.0 698.0 to 1202.0 1202.0 to 1562.0	$\pm 2.2^\circ$ $\pm 2.6^\circ$ $\pm 2.8^\circ$ $\pm 3.1^\circ$ $\pm 3.4^\circ$
Pt 50 Ohm DIN/IEC/JIS 1989 ITS-90	1.3850 (0.00385)	-200.0 to 200.0 200.0 to 550.0 550.0 to 850.0	$\pm 0.3^\circ$ $\pm 0.4^\circ$ $\pm 0.5^\circ$	-328.0 to 392.0 392.0 to 1022.0 1022.0 to 1562.0	$\pm 0.6^\circ$ $\pm 0.8^\circ$ $\pm 1.0^\circ$
Pt 200 Ohm DIN/IEC/JIS 1989 ITS-90	1.3850 (0.00385)	-200.0 to -120.0 -120.0 to 180.0 180.0 to 450.0 450.0 to 680.0 680.0 to 850.0	$\pm 0.1^\circ$ $\pm 0.1^\circ$ $\pm 0.2^\circ$ $\pm 0.2^\circ$ $\pm 0.3^\circ$	-328.0 to -184.0 -184.0 to 356.0 356.0 to 842.0 842.0 to 1256.0 1256.0 to 1562.0	$\pm 0.1^\circ$ $\pm 0.2^\circ$ $\pm 0.3^\circ$ $\pm 0.4^\circ$ $\pm 0.5^\circ$
Pt 500 Ohm DIN/IEC/JIS 1989 ITS-90	1.3850 (0.00385)	-200.0 to -90.0 -120.0 to 180.0 180.0 to 450.0 450.0 to 680.0 680.0 to 850.0	$\pm 0.1^\circ$ $\pm 0.1^\circ$ $\pm 0.2^\circ$ $\pm 0.2^\circ$ $\pm 0.3^\circ$	-328.0 to -194.0 -184.0 to 356.0 356.0 to 842.0 842.0 to 1256.0 1256.0 to 1562.0	$\pm 0.1^\circ$ $\pm 0.2^\circ$ $\pm 0.3^\circ$ $\pm 0.4^\circ$ $\pm 0.5^\circ$
Pt 1000 Ohm DIN/IEC/JIS 1989 ITS-90	1.3850 (0.00385)	-200.0 to 170.0 170.0 to 470.0 470.0 to 730.0 730.0 to 850.0	$\pm 0.1^\circ$ $\pm 0.1^\circ$ $\pm 0.2^\circ$ $\pm 0.2^\circ$	-328.0 to 338.0 338.0 to 878.0 878.0 to 1346.0 1346.0 to 1562.0	$\pm 0.1^\circ$ $\pm 0.2^\circ$ $\pm 0.3^\circ$ $\pm 0.4^\circ$
Pt 100 Ohm (Burns)	1.3902 (0.003902)	-195.6 to -100.0 -100.0 to 370.0 370.0 to 648.9	$\pm 0.1^\circ$ $\pm 0.2^\circ$ $\pm 0.3^\circ$	-320.1 to -148.0 -148.0 to 698.0 698.0 to 1200.0	$\pm 0.3^\circ$ $\pm 0.4^\circ$ $\pm 0.6^\circ$
Pt 100 Ohm (Old JIS 1981)	1.3916 (0.003916)	-200.0 to -140.0 -140.0 to 130.0 130.0 to 370.0 370.0 to 648.9	$\pm 0.1^\circ$ $\pm 0.2^\circ$ $\pm 0.2^\circ$ $\pm 0.3^\circ$	-328.0 to -220.0 -220.0 to 266.0 266.0 to 698.0 698.0 to 1200.0	$\pm 0.2^\circ$ $\pm 0.3^\circ$ $\pm 0.4^\circ$ $\pm 0.6^\circ$
Pt 100 Ohm (US Lab)	1.3926 (0.003926)	-200.0 to -140.0 -140.0 to 130.0 130.0 to 380.0 380.0 to 610.0 610.0 to 850.0	$\pm 0.1^\circ$ $\pm 0.2^\circ$ $\pm 0.2^\circ$ $\pm 0.3^\circ$ $\pm 0.4^\circ$	-328.0 to -220.0 -220.0 to 266.0 266.0 to 716.0 716.0 to 1130.0 1130.0 to 1562.0	$\pm 0.2^\circ$ $\pm 0.3^\circ$ $\pm 0.4^\circ$ $\pm 0.5^\circ$ $\pm 0.7^\circ$
Copper 10 Ohm (Minco)	1.4274 (0.004274)	-200.0 to -150.0 -150.0 to 90.0 90.0 to 260.0	$\pm 1.2^\circ$ $\pm 1.3^\circ$ $\pm 1.4^\circ$	-328.0 to -238.0 -238.0 to 194.0 194.0 to 500.0	$\pm 2.2^\circ$ $\pm 2.4^\circ$ $\pm 2.4^\circ$
Copper 50 Ohm	1.4280 (0.00428)	-50.0 to 150.0	$\pm 0.3^\circ$	-58.0 to 302.0	$\pm 0.5^\circ$
Ni 120 Ohm (Pure)	1.6720 (0.00672)	-80.0 to 260.0	$\pm 0.1^\circ$	-112.0 to 500.0	$\pm 0.2^\circ$

## Accessories

Standard Test Leads (Included with calibrator)

Part No. 020-0208

Two black and two red test leads three feet (1 meter) long with a spade lug on one end and a banana plug on the other end.

Magnetic Hanging Strap

Part No. 020-0236

Optional Ni-MH 1 Hour Charger w/4 Ni-MH AA Batteries

Part No. 020-0103

## Additional Information

This product is calibrated on equipment traceable to NIST and includes a Certificate of Calibration. Test Data is available for an additional charge.

Practical Instrument Electronics recommends a calibration interval of one year. Contact your local representative for recalibration and repair services.

## Warranty

Our equipment is warranted against defective material and workmanship (excluding batteries) for a period of three years from the date of shipment. Claims under warranty can be made by returning the equipment prepaid to our factory. The equipment will be repaired, replaced or adjusted at our option. The liability of Practical Instrument Electronics (PIE) is restricted to that given under our warranty. No responsibility is accepted for damage, loss or other expense incurred through sale or use of our equipment. Under no condition shall Practical Instrument Electronics, Inc. be liable for any special, incidental or consequential damage.

**Practical Instrument Electronics**

82 East Main Street Suite 3.14 • Webster, NY 14580 Tel: 585.872.9350 • Fax: 585.872.2638 • sales@piecal.com • www.piecal.com  
Page 20