**Instruction
Manual**

Models UT550/UT520
Digital Indicating Controllers
User's Manual for
Loop Control for Backup



IM 05D01C02-45E

Blank Page

Introduction

Thank you for purchasing the UT550/UT520 digital indicating controller.

■ How to Use the Manuals

Purpose	Manual Title	Description
Setup	1. Installation	Describes the tasks (installation, wiring, and others) required to make the controller ready for operations.
Basic operation	2. Initial Settings	Describes examples of setting PV input types, control output types, and alarm types. Making settings described herein allows you to carry out basic control.
Operating procedures and troubleshooting	3. Operations 4.1 Troubleshooting	Describes key operation sequences. For operation control through external contact inputs, See "1.5 Terminal Wiring Diagrams"
Brief operation	5.1 Parameter Map	Contains the parameter map used as a guideline for setting parameters.
Function description and setpoint recording	5.2 Lists of Parameters	Briefly describes the functions of parameters. In addition, each parameter table has a User Setting column, where you can record your setpoints when setting them in the controller.

■ Controllers Applicable to Loop Control for Backup

The specification codes of the UT550 and UT520 applicable to loop control for backup are given in the table below.

UT550-01	UT550-11	UT550-21	UT550-31	UT550-41
UT550-02	UT550-12	UT550-22	UT550-32	UT550-42
UT550-04	UT550-14	UT550-24	UT550-34	UT550-44
UT520-07				
UT520-08				

■ Regarding This User's Manual

- (1) This manual should be provided to the end user. Keep an extra copy or copies of the manual in a safe place.
- (2) Read this manual carefully to gain a thorough understanding of how to operate this product before starting operation.
- (3) This manual describes the functions of this product. Yokogawa M&C Corporation (hereinafter simply referred to as Yokogawa) does not guarantee the application of these functions for any particular purpose.
- (4) Under absolutely no circumstances may the contents of this manual, in part or in whole, be transcribed or copied without permission.
- (5) The contents of this manual are subject to change without prior notice.
- (6) Every effort has been made to ensure that the details of this manual are accurate.

However, should any errors be found or important information be omitted, please contact your nearest Yokogawa representative or our sales office.

■ Safety Precautions

The following symbol is indicated on the controller to ensure safe use.



This symbol on the controller indicates that the operator must refer to an explanation in the user's manual in order to avoid the risk of injury or death of personnel or damage to the instrument. The manual describes how the operator should exercise special care to avoid electric shock or other dangers that may result in injury or loss of life.

The following symbols are used in the hardcopy user's manuals and in the user's manual supplied on the CD-ROM.



Indicates that operating the hardware or software in a particular manner may damage it or result in a system failure.



Draws attention to information that is essential for understanding the operation and/or features of the controller.

■ Regarding Force Majeure

Yokogawa M&C Corporation assumes no liability for any loss or damage, direct or indirect, caused by the use of or unpredictable defects of the product.

Models UT550/UT520

Digital Indicating Controllers

User's Manual for Loop Control for Backup

IM 05D01C02-45E 1st Edition

CONTENTS

1.	Installation	1-1
1.1	Model and Suffix Codes	1-1
1.2	How to Install	1-2
1.3	How to Connect Wires	1-5
1.4	Hardware Specifications	1-7
1.5	Terminal Wiring Diagrams	1-13
2.	Initial Settings	2-1
2.1	Names and Functions of Front Panel Parts	2-2
2.2	Setting UT mode (Setting First at Power-on)	2-3
2.3	Changing UT mode	2-4
2.4	Setting PV Input Type	2-5
2.5	Changing Tracking Input Type	2-9
2.6	Setting Control Output Type (except for a Position Proportional Controller)	2-10
2.7	Calibrating Valve Position (for a Position Proportional Controller Only)	2-12
2.8	Initializing Parameters	2-14
2.9	Changing Alarm Type	2-15
2.10	Description of Multiple Setpoints and PID	2-18
3.	Operations	3-1
3.1	Monitoring-purpose Operating Displays Available during Operation	3-1
3.2	Setting Target Setpoint (SP)	3-3
3.3	Performing/Canceling Auto-tuning	3-3
3.4	Setting PID Manually	3-5
3.5	Setting Alarm Setpoints	3-6
3.6	Selecting Target Setpoint Numbers (SPN)	3-7
3.7	Switching between Run and Stop	3-8
3.8	Switching between AUTO and MAN	3-8
3.9	Manipulating Control Output during Manual Operation	3-9
3.10	Backup the Control Output	3-11

4.	Troubleshooting and Maintenance	4-1
4.1	Troubleshooting	4-1
4.2	Maintenance	4-5
4.2.1	Cleaning	4-5
4.2.2	Replacing Brackets	4-5
4.2.3	Attaching Terminal Cover	4-5
4.2.4	Replacing Parts with a Limited Service Life	4-7
4.2.5	Replacing Control Output Relays	4-7
5.	Parameters	5-1
5.1	Parameter Map	5-1
5.2	Lists of Parameters	5-6
6.	Function Block Diagram and Descriptions	6-1

1. Installation

This chapter describes installation, wiring, and other tasks required to make the controller ready for operation.

1.1 Model and Suffix Codes

Before using the controller, check that the model and suffix codes match your order.

Model	Suffix Code	Description
UT550		Digital indicating controller (provided with retransmission output and 15 VDC loop power supply as standard)
Type	-0	Standard type
	-1	Position proportional type
	-2	Heating/cooling type
	-3	Standard type (with 24 V DC loop power supply)
	-4	Position proportional type (with 24 V DC loop power supply)
Optional functions	0	None
	1	With communication, auxiliary analog input, 6 additional DIs and 4 additional DOs
	2	With communication, auxiliary analog input, and 1 additional DI
	3	With 5 additional DIs and 4 additional DOs
	4	With auxiliary analog input and 1 additional DI

Model	Suffix Code	Description
UT520		Digital indicating controller (provided with retransmission output and 15 VDC loop power supply as standard)
Type	-0	Standard type
Optional functions	0	None
	7	Communication, auxiliary analog input, and 2 additional DIs
	8	Auxiliary analog input and 2 additional DIs

Check that the following items are provided:

- Digital indicating controller (of ordered model): 1
- Brackets (mounting hardware): 1 pair
- Unit label: 1
- User's Manuals for Single-loop Control: 5 (A2 size)
- User's Manual (Reference) (CD-ROM Version): 1

■ Correspondence between the Model and Suffix Codes, and the Contact Input/Output Terminals Provided

Check the model ordered and the presence/absence of contact inputs and outputs in the following table.

✓ indicate that the contacts are available.

Model and Suffix Codes	Contact input terminals								Contact output terminals						
	DI1	DI2	DI3	DI4	DI5	DI6	DI7	DI8	DO1	DO2	DO3	DO4	DO5	DO6	DO7
UT550-□0	✓	✓							✓	✓	✓				
UT550-□1	✓	✓	✓	✓	✓	✓	✓	✓	✓	✓	✓	✓	✓	✓	✓
UT550-□2	✓	✓						✓	✓	✓	✓				
UT550-□3	✓	✓	✓	✓	✓	✓	✓		✓	✓	✓	✓	✓	✓	✓
UT550-□4	✓	✓						✓	✓	✓	✓				

Note: For details on the functions of contact inputs/outputs, see "1.5 Terminal Wiring Diagrams".

✓ indicate that the contacts are available.

Model and Suffix Codes	Contact input terminals								Contact output terminals						
	DI1	DI2	DI3	DI4	DI5	DI6	DI7	DI8	DO1	DO2	DO3	DO4	DO5	DO6	DO7
UT520-00	✓	✓							✓	✓	✓				
UT520-07	✓	✓	✓					✓	✓	✓	✓				
UT520-08	✓	✓	✓					✓	✓	✓	✓				

Note: For details on the functions of contact inputs/outputs, see "1.5 Terminal Wiring Diagrams".

1.2 How to Install

NOTE

To install the controller, select a location where:

1. no one may accidentally touch the terminals,
2. mechanical vibrations are minimal,
3. corrosive gas is minimal,
4. temperature can be maintained at about 23°C and the fluctuation is minimal,
5. no direct radiant heat is present,
6. no magnetic disturbances are caused,
7. no wind blows against the terminal board (reference junction compensation element),
8. no water is splashed,
9. no flammable materials are around,

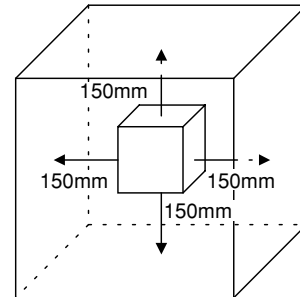

Never place the controller directly on flammable items or equipment.

If the controller has to be installed close to flammable items or equipment, be sure to provide shielding panels all around the controller, at least 150mm away from every side; the panels should be made of either 1.43mm-thick metal-plated steel plates or 1.6mm-thick uncoated steel plates.

● Installation Position

Install the controller at an angle within 30° from horizontal with the front panel facing upward. Do not install it facing downward. The position of right and left sides should be horizontal.

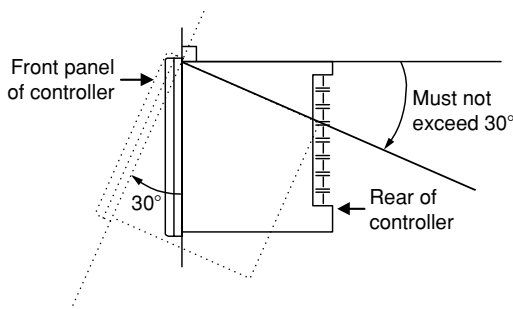

External Dimensions and Panel Cutout Dimensions

UT550

Unit: mm

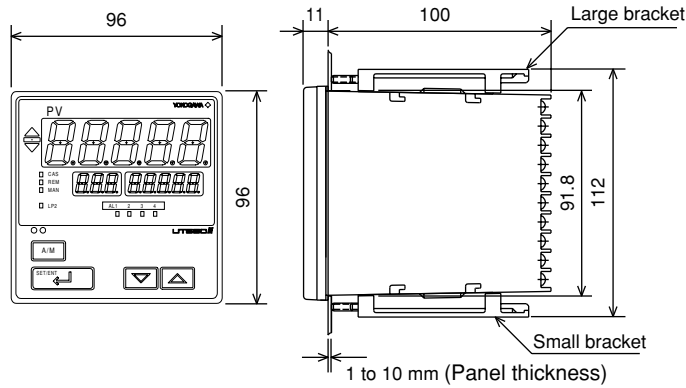

General installation

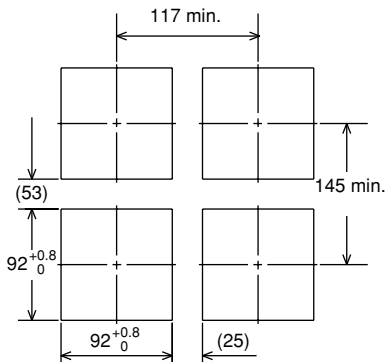

Side-by-side close installation

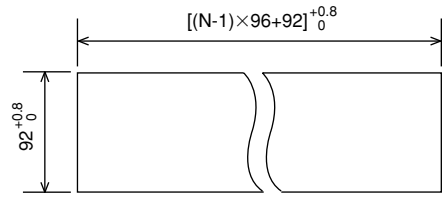

"N" stands for the number of controllers to be installed. However, the measured value applies if N ≥ 5.

UT520

Unit: mm

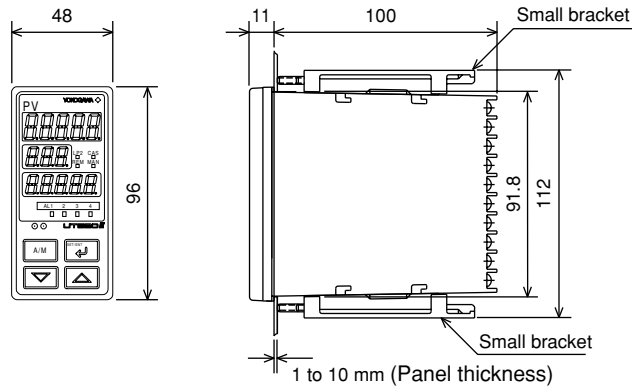

General installation

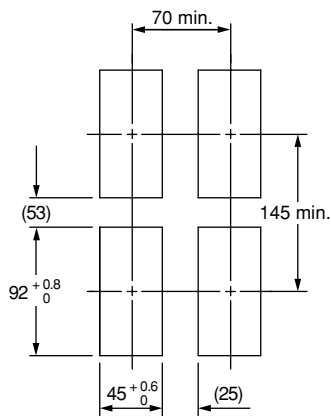

Side-by-side close installation

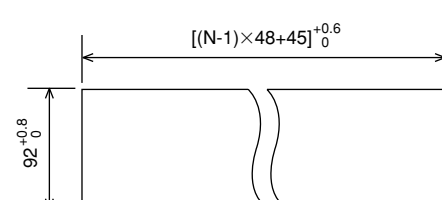

"N" stands for the number of controllers to be installed. However, the measured value applies if N ≥ 5.

■ How to Install



CAUTION

Turn off the power to the controller before installing it on the panel because there is a possibility of electric shock.

After opening the mounting hole on the panel, follow the procedures below to install the controller:

1. Insert the controller into the opening from the front of the panel so that the terminal board on the rear is at the far side.
2. Set the brackets in place on the top and bottom of the controller as shown in the figure below, then tighten the screws of the brackets. Take care not to overtighten them.

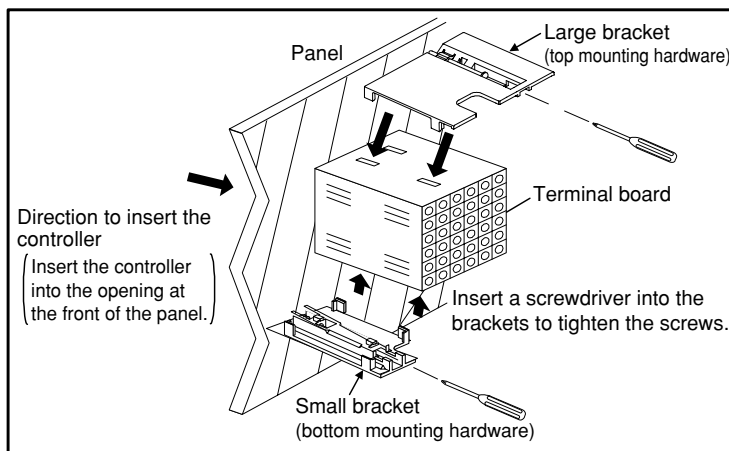

1.3 How to Connect Wires



CAUTION

- 1) Before carrying out wiring, turn off the power to the controller and check that the cables to be connected are not alive with a tester or the like because there is a possibility of electric shock.
- 2) Wiring must be carried out by personnel who have basic electrical knowledge and practical experience.



NOTE

- 1) Provide power from a single-phase instrument power supply. If there is a lot of noise in the power line, insert an insulating transformer into the primary side of the line and use a line filter (recommended part: ZAC2205-00U from TDK) on the secondary side. As a countermeasures against noise, do not place the primary and secondary power cables close to each other.
- 2) For thermocouple input, use shielded compensating lead wires for wiring. For RTD input, use shielded wires that have low conductor resistance and cause no significant differences in resistance between the three wires. The cables to be used for wiring, terminal specifications, and recommended parts are as shown below.
- 3) Control output relays may be replaced. However, because they have a life of 100,000 times that of the resistance load, use auxiliary relays to turn on/off a load.
- 4) The use of inductance (L) loads such as auxiliary relays, motors and solenoid valves causes malfunction or relay failure; always insert a CR filter for use with alternating current or a diode for use with direct current, as a spark-removal surge suppression circuit, into the line in parallel with the load.

■ For DC Relay Wiring

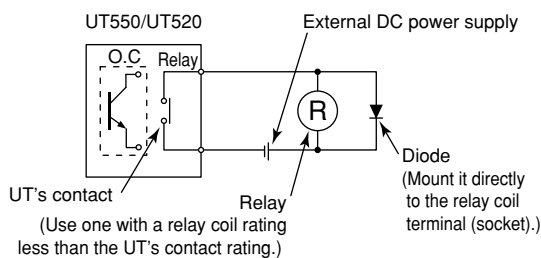

■ For AC Relay Wiring

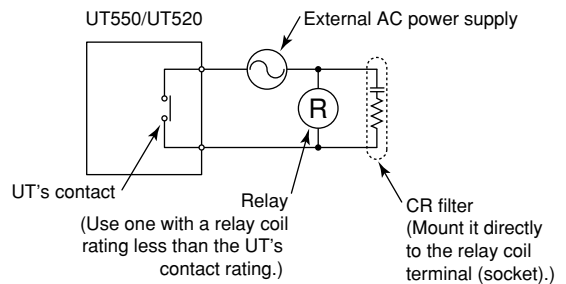

● Cable Specifications and Recommended Cables

Purpose	Name and Manufacturer
Power supply, grounding, relay contact outputs	600 V PVC insulated wires, JIS C 3307, 0.9 to 2.0 mm ²
Thermocouple	Shielded compensating lead wires, JIS C 1610, □X-□-□-□ (See Yokogawa Electric's GS 6B1U1-E.)
RTD	Shielded wires (three conductors), UL2482 (Hitachi Cable)
Other signals	Shielded wires

● Recommended Terminal Lugs

Applicable wire size	Tightening torque
0.3 to 1.65 mm ²	0.8 N·m or less

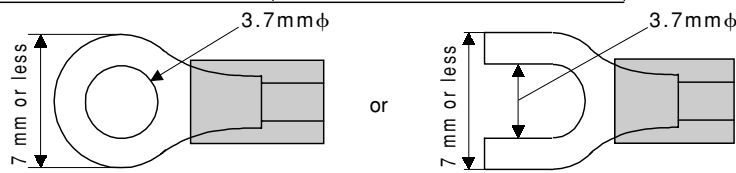

● Terminal Covers

Target Model	Part Number	Sales Unit
For UT550	T9115YD	1
For UT520	T9115YE	1

1.4 Hardware Specifications

PV Input Signals

- Number of inputs: 1 (terminals①-⑫-⑬)
- Input type: Universal input system. The input type can be selected with the software.
- Sampling period: Can be selected from 50, 100, 200 and 500 ms.
- Burnout detection: Functions at TC, RTD, standard signal (0.4 to 2 V or 1 to 5 V)
Upscale, downscale, and off can be specified.
For standard signal, burnout is determined to have occurred if it is 0.1 V or less.
- Input bias current: 0.05 μ A (for TC or RTD b-terminal)
- Measurement current (RTD): About 0.13 mA
- Input resistance: 1 M Ω or more for thermocouple or mV input
About 1 M Ω for DC voltage input
- Allowable signal source resistance: 250 Ω or less for thermocouple or mV input
Effects of signal source resistance: 0.1 μ V/ Ω or less
2 k Ω or less for DC voltage input
Effects of signal source resistance: About 0.01%/100 Ω
- Allowable wiring resistance: for RTD input
Maximum 150 Ω /wire: Conductor resistance between three wires should be equal
However, 10 Ω /wire for a maximum range of -150.0 to 150.0 $^{\circ}$ C.
Wire resistance effect: \pm 0.1 $^{\circ}$ C /10 Ω
- Allowable input voltage: \pm 10 V DC for thermocouple, mV, or RTD input
 \pm 20 V DC for DC voltage input
- Noise rejection ratio: 40 dB (50/60 Hz) or more in normal mode
120 dB (50/60 Hz) or more in common mode
- Reference junction compensation error: \pm 1.0 $^{\circ}$ C (15 to 35 $^{\circ}$ C)
 \pm 1.5 $^{\circ}$ C (0 to 15 $^{\circ}$ C, 35 to 50 $^{\circ}$ C)
- Applicable standards: JIS, IEC, DIN (ITS-90) for thermocouples and RTD

Auxiliary Analog Input Signals (Tracking Input)

Available only for controllers with auxiliary input terminals.

- Number of inputs: 1 (terminals⑭-⑮)
- Input type: Settable in a range of 0-2, 0-10, 0.4-2.0, or 1-5 V DC
- Sampling period: 100, 200 and 500 ms
The sampling period of an auxiliary analog input signal is associated with the PV input's sampling period. If the PV input's sampling period is 50 ms, however, the sampling period of an auxiliary analog input signal lengthens to 100 ms.
- Input resistance: About 1 M Ω
- Input accuracy: \pm 0.3% \pm 1 digit of input span for 0 to 2 V DC
 \pm 0.2% \pm 1 digit of input span for 0 to 10 V DC
 \pm 0.375% \pm 1 digit of input span for 0.4 to 2.0 V DC
 \pm 0.3% \pm 1 digit of input span for 1 to 5 V DC
Under standard operating conditions (23 \pm 2 $^{\circ}$ C, 55 \pm 10% RH, power frequency of 50/60 Hz)

Feedback Resistance Input

Provided for position proportional type only (terminals 45-46-47)

- Slide resistance value: 100 Ω to 2.5 kΩ of overall resistance (burnout detection for sliding wire provided)
- Measuring resolution: ±0.1% of overall resistance

Loop Power Supply

Power is supplied to a two-wire transmitter.

(15 V DC: terminals 14-15; 24 V DC: terminals 43-44)

A resistor (10 to 250 Ω) connected between the controller and transmitter converts a current signal into a voltage signal, which is then read via the PV input terminal.

Supply voltage: 14.5 to 18.0 V DC, max. 21 mA (provided with a protection circuit against a field short-circuit); 21.6 to 28.0 V DC, max. 30 mA (only for models with 24 V DC loop power supply)

Retransmission Output

Either PV, target setpoint, or control output is output.

Either the retransmission output or the loop power supply can be used with terminals 14-15.

- Number of outputs: 1 or 2 (terminals 14-15, terminals 16-17)
- Output signal: 4-20, 0-20, 20-4, or 20-0 mA DC (where, outputting signal levels of less than 0 mA is not feasible)
- Load resistance: 600 Ω or less
- Output accuracy: ±0.1% of span (±5% of span for 1 mA or less.)
Under standard operating conditions (23 ±2°C, 55 ±10% RH, power frequency of 50/60 Hz)

Control Output

Universal output system, The output type can be selected with the software.

Relay contact output(s) for the position proportional type

- Current output
(Standard type: terminals 16-17; heating-side output: terminals 16-17, cooling-side output: terminals 46-47)

Number of outputs	1 or 2 (two for heating/cooling type), switched between a voltage pulse output and current output.
Output signal	4-20, 0-20, 20-4, or 20-0 mA DC
Load resistance	600 Ω or less
Output accuracy	±0.1% of span (±5% of span for 1 mA or less) Under standard operating conditions (23 ± 2 °C, 55 ± 10% RH, power frequency of 50/60 Hz)

- Voltage pulse output
(Standard type: terminals 16-17; heating-side output: terminals 16-17, cooling-side output: terminals 46-47)

Number of outputs	1 or 2 (two for heating/cooling type), switched between a voltage pulse output and current output.
Output signal	On-voltage = 12 V or more (load resistance: 600 Ω or more) Off-voltage = 0.1 V DC or less
Resolution	10 ms or 0.1% of output, whichever is larger

- Relay contact output
(Standard type: terminals ①-②-③, heating-side output: terminals ①-②-③, cooling-side output: terminals ④⑧-④⑨-⑤⑩, position proportional type: terminals ④⑧-④⑨-⑤⑩)

Number of outputs	1 or 2 (two for heating/cooling type)
Output signal	Three terminals (NC, NO, and common)
Contact rating	250 V AC or 30 V DC, 3 A (resistance load)
Resolution	10 ms or 0.1% of output, whichever is larger

Contact Inputs

- Purpose: Target setpoint selection, remote/local mode switching, and run/stop switching
- Number of inputs: Differs with model and suffix codes as shown in the table below.

Model and Suffix Codes	Number of Inputs
UT550-□0	2
UT550-□1	8
UT550-□2	3
UT550-□3	7
UT550-□4	3
UT520-00	2
UT520-07	4
UT520-08	4

- Input type: Non-voltage contact or transistor open collector input
- Input contact rating: 12 V DC, 10 mA or more
- On/off determination: For non-voltage contact input, contact resistance of 1 kΩ or less is determined as “on” and contact resistance of 20 kΩ or more as “off.”
For transistor open collector input, input voltage of 2 V or less is determined as “on” and leakage current must not exceed 100 μA when “off.”
- Minimum status detection hold time: PV input’s sampling period ×3

Contact Outputs

- Purpose: Alarm output, FAIL output, and others
- Number of outputs: Differs with the model and suffix code as shown in the table below.

Model and Suffix Codes	Number of Outputs
UT550-□0	3
UT550-□1	7
UT550-□2	3
UT550-□3	7
UT550-□4	3
UT520-00	3
UT520-07	3
UT520-08	3

- Relay contact rating: 240 V AC, 1 A, or 30 V DC, 1 A
- Transistor contact rating: 24 V DC, 50 mA

Display Specifications

- PV display:
5-digit, 7-segment, red LEDs, character height of 20 mm for UT550 and 12 mm for UT520
- Setpoint display: 3-digit and 5-digit, 7-segment, red LEDs, character height of 9.3 mm (for both UT520 and UT550)
- Status indicating lamps: LEDs

Safety and EMC Standards

- Safety: Compliant with IEC1010-1: 1990 and EN61010-1: 1992
Approved by CSA1010
CSA1010 installation category (overvoltage category): CATII (IEC1010-1)
Approved by UL508
- EMC standards: This instrument complies with the following EMC standards (the instrument continues to operate at a measuring accuracy of within $\pm 20\%$ of the range during tests):
 - EMI (emission), EN55011: Class A Group 1
 - EMS (immunity), EN50082-2: 1995

Construction, Installation, and Wiring

- Construction: Only the front panel is dust-proof and drip-proof (protection class IP55)
For side-by-side close installation the controller loses its dust-proof and drip-proof protection.
- Material: ABS resin and polycarbonate
- Case color: Black
- Weight: About 1 kg or less
- Dimensions:
UT550 — 96 (W) \times 96 (H) \times 100 (depth from panel face) mm
UT520 — 48 (W) \times 96 (H) \times 100 (depth from panel face) mm
- Installation: Panel-mounting type. With top and bottom mounting hardware (1 each)
- Panel cutout dimensions:
UT550 — $92^{+0.8}_0$ (W) \times $92^{+0.8}_0$ (H) mm
UT520 — $45^{+0.6}_0$ (W) \times $92^{+0.8}_0$ (H) mm
- Installation position: Up to 30° upward facing
(not designed for facing downward)
- Wiring: M3.5 screw terminals (for signal wiring and power/ground wiring as well)

Power Supply Specifications

- Power supply: Rated voltage of 100 to 240 V AC ($\pm 10\%$), 50/60 Hz
- Power consumption: Max. 20 VA (8.0 W max.)
- Data backup: Non-volatile memory (can be written to up to 100,000 times)
- Withstanding voltage
 - Between primary terminals* and secondary terminals**:
At least 1500 V AC for 1 minute (Note)
 - Between primary terminals* and grounding terminal:
At least 1500 V AC for 1 minute (Note)

- Between grounding terminal and secondary terminals^{**}:
At least 1500 V AC for 1 minute
- Between secondary terminals^{**}:
At least 500 V AC for 1 minute
- * Primary terminals indicate power terminals and relay output terminals
- ^{**}Secondary terminals indicate analog I/O signal, voltage pulse output, and contact input terminals

Note : The withstanding voltage is specified as 2300 V AC per minute to provide a margin of safety.

- Insulation resistance: 20 M Ω or more at 500 V DC between power terminals and grounding terminal
- Grounding: Class 3 grounding (grounding resistance of 100 Ω or less)

Signal Isolations

- PV input terminals: Isolated from other input/output terminals. Not isolated from the internal circuit.
- Auxiliary analog input terminals: Isolated from other input/output terminals and the internal circuit.
- 15 V DC loop power supply terminals: Not isolated from analog current output nor voltage pulse control output. Isolated from other input/output terminals and internal circuit.
- 24 V DC loop power supply terminals: Isolated from 4-20 mA analog output, other input/output terminals and the internal circuit.
- Analog current output terminals (for control output and retransmission): Not isolated between current outputs nor from 15 V DC loop power supply and voltage pulse control output. Isolated from other input/output terminals and internal circuit.
- Voltage pulse control output terminals: Not isolated from current outputs and 15 V DC loop power supply. Isolated from other input/output terminals and internal circuit.
- Relay contact control output terminals: Isolated between contact output terminals and from other input/output terminals and internal circuit.
- Contact input terminals: Not isolated between contact input terminals and from communication terminals. Isolated from other input/output terminals and internal circuit.
- Relay contact output terminals: Not isolated between relay contact outputs. Isolated from other input/output terminals and internal circuit.
- Transistor contact output terminals: Not isolated between transistor contact outputs. Isolated from other input/output terminals and internal circuit.
- RS-485 communication terminals: Not isolated from contact input terminals. Isolated from other input/output terminals and internal circuit.
- Feedback slide resistance input terminals: Not isolated from analog current output terminals (control, retransmission), 15 V DC loop power supply, and voltage pulse control outputs. Isolated from other input/output terminals and internal circuit.
- Power terminals: Isolated from other input/output terminals and internal circuit.
- Grounding terminals: Isolated from other input/output terminals and internal circuit.

Environmental Conditions

- Normal operating conditions:
 - Ambient temperature: 0 to 50°C (40°C or less for side-by-side close installation)
 - Temperature change rate: 10°C/h or less
 - Ambient humidity: 20 to 90% RH (no condensation allowed)
 - Magnetic field: 400 A/m or less
 - Continuous vibration at 5 to 14 Hz: Full amplitude of 1.2 mm or less
 - Continuous vibration at 14 to 150 Hz: 4.9 m/s² or less
 - Short-period vibration: 14.7 m/s², 15 seconds or less
 - Shock: 14.7 m/s² or less, 11 ms
 - Installation height: Height above sea level of 2000 m or less
 - Warm-up time: 30 minutes or more after power on
- Transportation and storage conditions:
 - Temperature: -25 to 70°C
 - Temperature change rate: 20°C/h or less
 - Humidity: 5 to 95% RH (no condensation allowed)
- Effects of changes in operating conditions
 - Effects from changes in ambient temperature:
 - On voltage or thermocouple input, $\pm 1 \mu\text{V}/^\circ\text{C}$ or $\pm 0.01\%$ of F.S./ $^\circ\text{C}$, whichever is larger
 - On auxiliary analog input, $\pm 0.02\%$ of F.S./ $^\circ\text{C}$
 - On RTD input, $\pm 0.05^\circ\text{C}/^\circ\text{C}$ (ambient temperature) or less
 - On analog output, $\pm 0.05\%$ of F.S./ $^\circ\text{C}$ or less
 - Effects from power supply fluctuation (within rated voltage range)
 - On analog input, $\pm 1 \mu\text{V}/10 \text{ V}$ or $\pm 0.01\%$ of F.S./10 V, whichever is larger
 - On analog output, $\pm 0.05\%$ of F.S./ 10 V or less

1.5 Terminal Wiring Diagrams



NOTE

Do not use unassigned terminals as relay terminals.

Terminal wiring diagrams are shown on and after the next page.

UT550 Loop Control for Backup

*Wiring can only be carried out for controllers with 24 V DC sensor power supply.

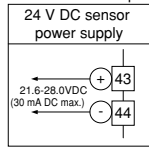

Control output

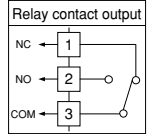

Contact rating: 250 V AC, 3 A
30 V DC, 3 A (resistance load)

Note: Select this option from the OT1 parameter.
*Time proportional PID relay contact output is configured at factory before shipment.

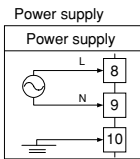

Allowable range: 100-240 V AC (±10%)
(free voltage)
50/60 Hz shared

CAUTION
Before carrying out wiring, turn off the power to the controller and check that cables to be connected are not alive with a tester or the like because there is a possibility of electric shock.

* The functionality of a contact output can be varied by changing the setting of the contact output registration parameter.

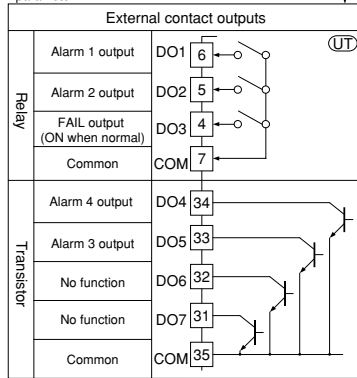

Relay contact rating: 240 V AC, 1 A
30 V DC, 1 A (resistance load)
Transistor contact rating: 24 V DC, 50 mA

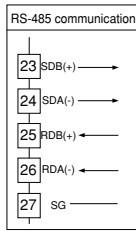

* Wiring can only be carried out for controllers with communication functions.
Maximum baud rate: 9600 bps

Tracking Signal (host device operation output)

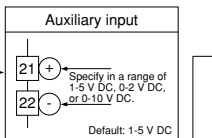

* Not configured at factory before shipment. See "2. Initial Settings".

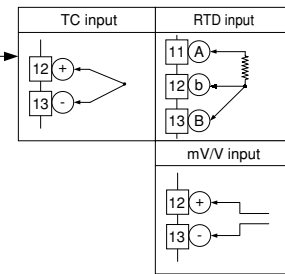

Receiving 4-20 mA DC Current Signals with the Controller

* When receiving 4-20 mA DC current signals, set the PV input type to 1-5 V DC (setpoint "41").

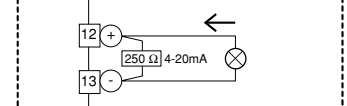

Note: Connecting a 250 Ω resistor to the terminals is optional.
Model: X010-250-2 (resistor with M3.5 crimp-on terminal lugs)

NOTE
Installation category (overvoltage category): II (IEC1010-1)

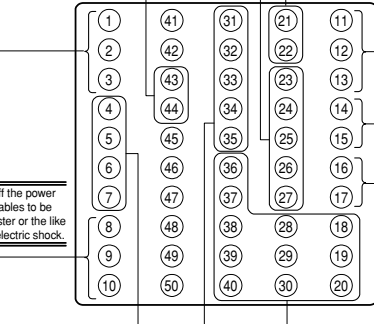

Control output

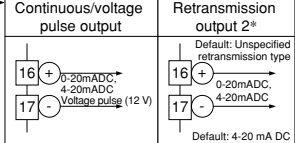

Note: Select this option from the OT1 parameter.
*Retransmission output 2 is available only when "relay" is selected as the type of control output.

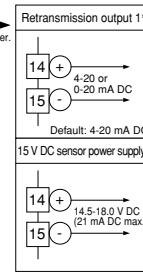

* Factory-set to "PV retransmission."

Load resistance: 600 Ω or less

* Retransmission output 1 is not available if a 15 V DC sensor power supply is used.

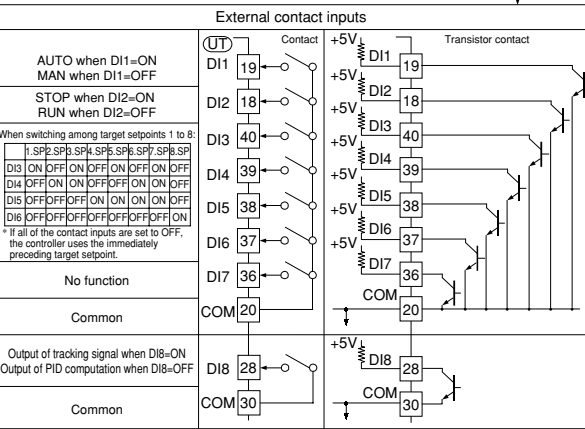

Note: External Contact Input
If the power is turned on when the external contact input is OFF, the mode (SPN, R/L, or A/M) existing before the power is turned off will be continued. (except for RUN/STOP)

* OT1 is a setup parameter.
You can change the settings of the parameter OT1 to change the control output type. See "2. Initial Settings".

Correspondence between parameter OT1 and control output types			
OT1=0 (factory-set default)	OT1=1	OT1=2	OT1=3
Time proportional control Relay output (terminals ①, ② and ③)	Time proportional control Voltage pulse output (terminals ⑤ and ⑦)	Current output (terminals ⑨ and ⑩)	On-off control Relay output (terminals ①, ② and ③)

UT550 Heating/Cooling Loop Control for Backup

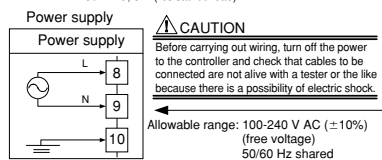
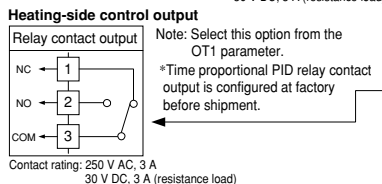
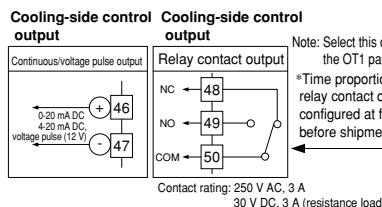

* The functionality of a contact output can be varied by changing the setting of the contact output registration parameter.

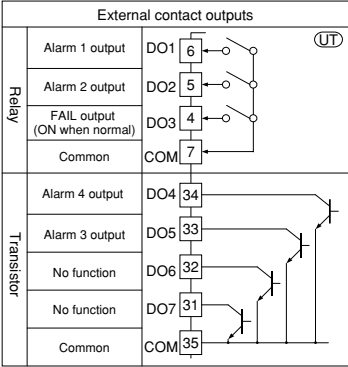

* OT1 is a setup parameter. You can change the settings of the parameter OT1 to change the control output type. See "2. Initial Settings".

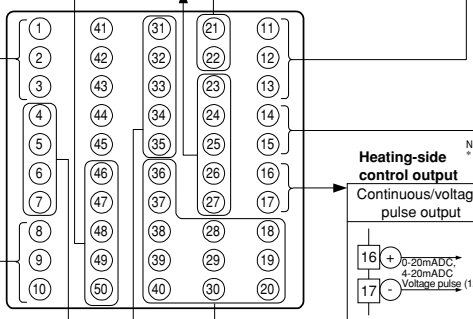
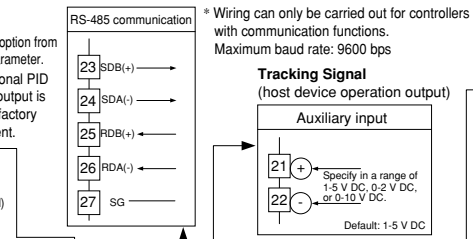

* The functionality of a contact input can be varied by changing the setting of the contact input registration parameter.

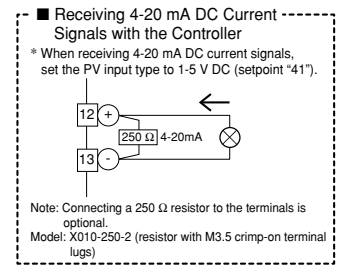
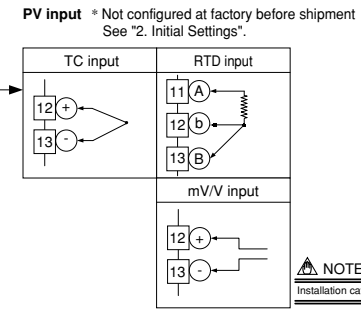
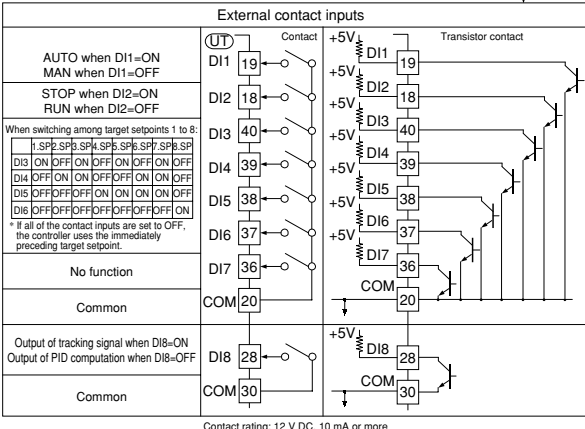

NOTE
Installation category (overvoltage category): II (IEC1010-1)

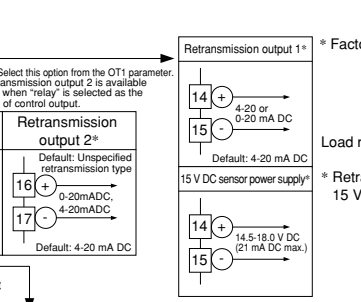

Note: External Contact Input
If the power is turned on when the external contact input is OFF, the mode (SPN, R/L, or A/M) existing before the power is turned off will be continued. (except for RUN/STOP)

Correspondence between parameter OT1 and heating side output types/cooling side output types								
OT1=4 (factory-set default)	OT1=5	OT1=6	OT1=7	OT1=8	OT1=9	OT1=10	OT1=11	OT1=12
Heating side: Relay output (terminals ①, ② and ③) Cooling side: Relay output (terminals ④, ⑤ and ⑥)	Heating side: Voltage pulse output (terminals ⑥ and ⑦) Cooling side: Relay output (terminals ⑧, ⑨ and ⑩)	Heating side: Current output (terminals ⑥ and ⑦) Cooling side: Relay output (terminals ⑧, ⑨ and ⑩)	Heating side: Relay output (terminals ①, ② and ③) Cooling side: Voltage pulse output (terminals ④ and ⑤)	Heating side: Voltage pulse output (terminals ⑥ and ⑦) Cooling side: Voltage pulse output (terminals ⑧ and ⑨)	Heating side: Current output (terminals ⑥ and ⑦) Cooling side: Voltage pulse output (terminals ⑧ and ⑨)	Heating side: Relay output (terminals ①, ② and ③) Cooling side: Current output (terminals ④ and ⑤)	Heating side: Voltage pulse output (terminals ⑥ and ⑦) Cooling side: Current output (terminals ⑧ and ⑨)	Heating side: Current output (terminals ⑥ and ⑦) Cooling side: Current output (terminals ⑧ and ⑨)

The types of control output, "relay output" and "voltage pulse output" shown in the table above refer to those of time proportional control. To change to a relay output for on-off control, select "Relay Terminals" and change the setpoint of the proportional band to "0."

UT550 Position Proportional Loop Control for Backup

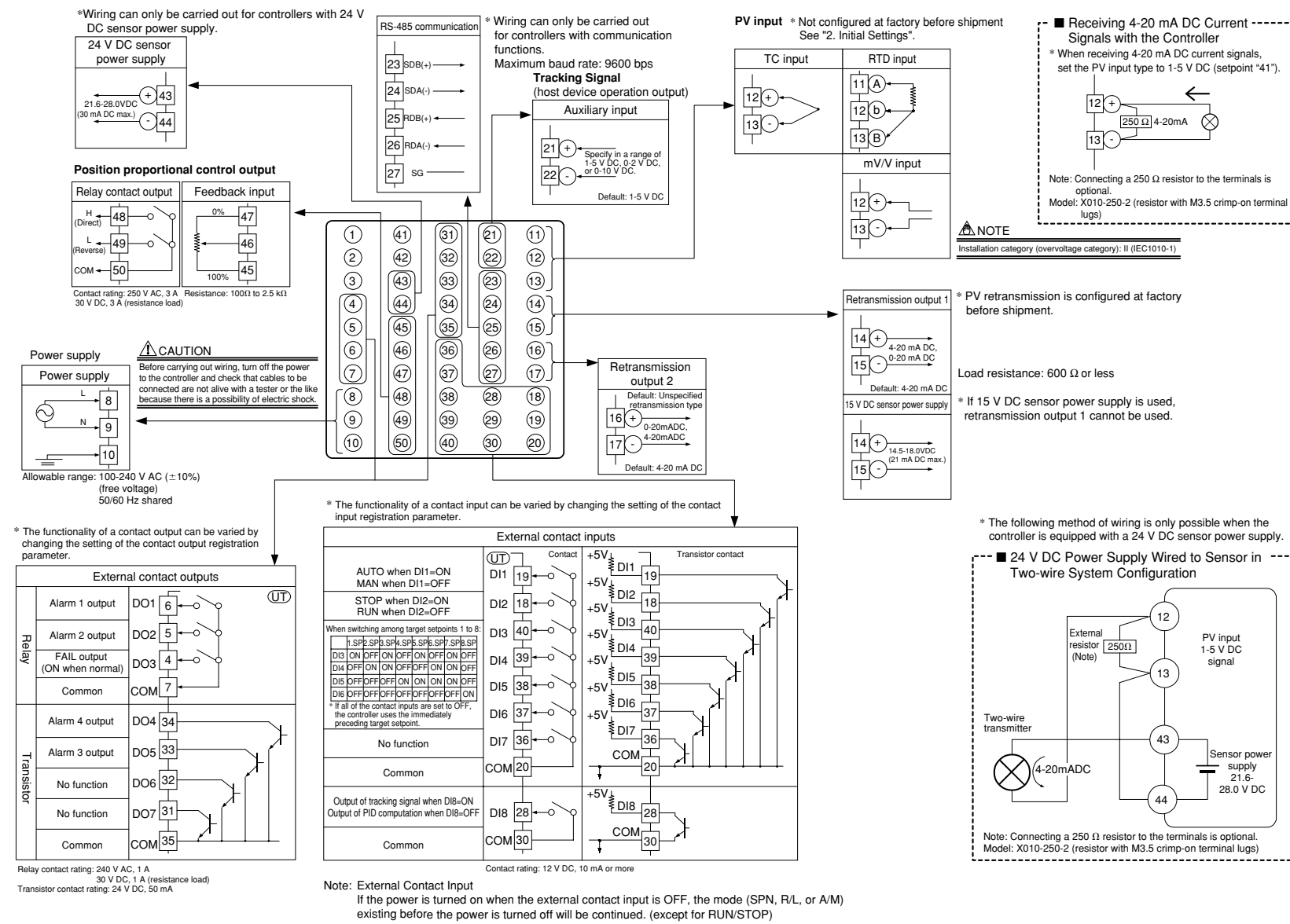

UT520 Loop Control for Backup

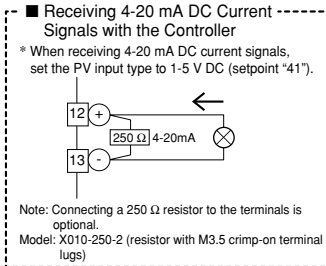
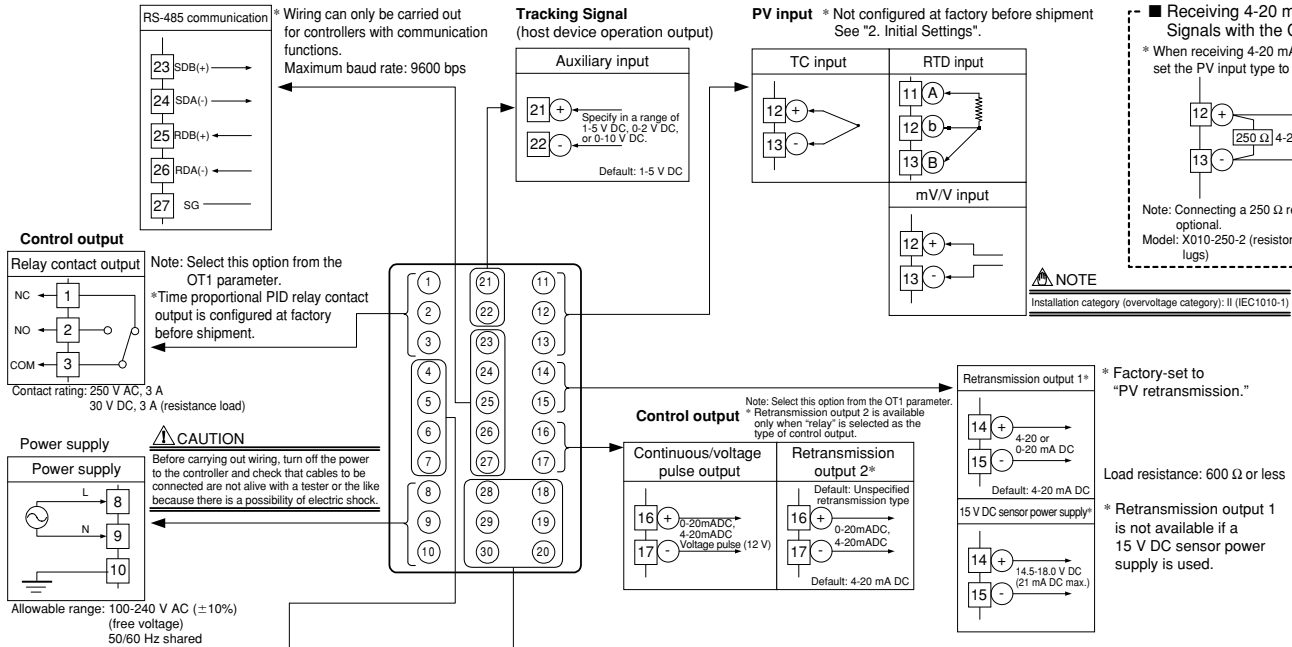

NOTE
 Installation category (overvoltage category): II (IEC1010-1)

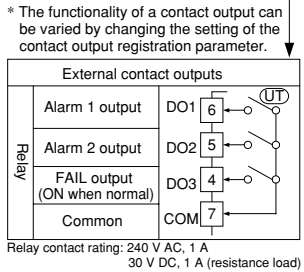

Note: External Contact Input
 If the power is turned on when the external contact input is OFF, the mode (SPN, R/L, or A/M) existing before the power is turned off will be continued. (except for RUN/STOP)

* The functionality of a contact input can be varied by changing the setting of the contact input registration parameter.

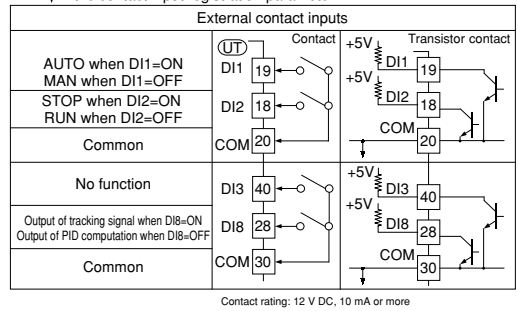

* OT1 is a setup parameter.
 You can change the settings of the parameter OT1 to change the control output type.
 See "2. Initial Settings".

Correspondence between parameter OT1 and control output types

OT1=0 (factory-set default)	OT1=1	OT1=2	OT1=3
Time proportional control Relay output (terminals ①, ② and ③)	Time proportional control Voltage pulse output (terminals ⑥ and ⑦)	Current output (terminals ⑥ and ⑦)	On-off control Relay output (terminals ①, ② and ③)

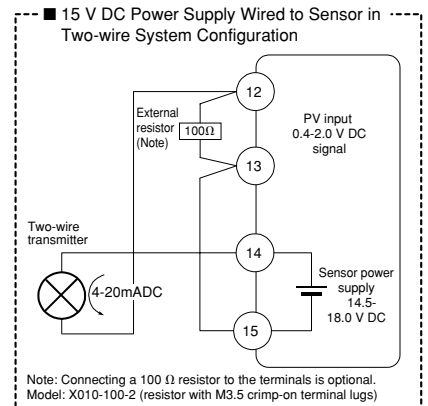

Blank Page

2. Initial Settings

This chapter describes examples of setting PV input types, control output types, and alarm types. Carrying out settings described herein allows you to perform basic control. Refer to examples of various settings to understand how to set parameters required. Refer to “5.1 Parameter Map” for an easy to understand explanation of setting various parameters. If you cannot remember how to carry out an operation during setting, press the  key for more than 3 seconds. This brings you to the display (operating display) that appears at power-on.

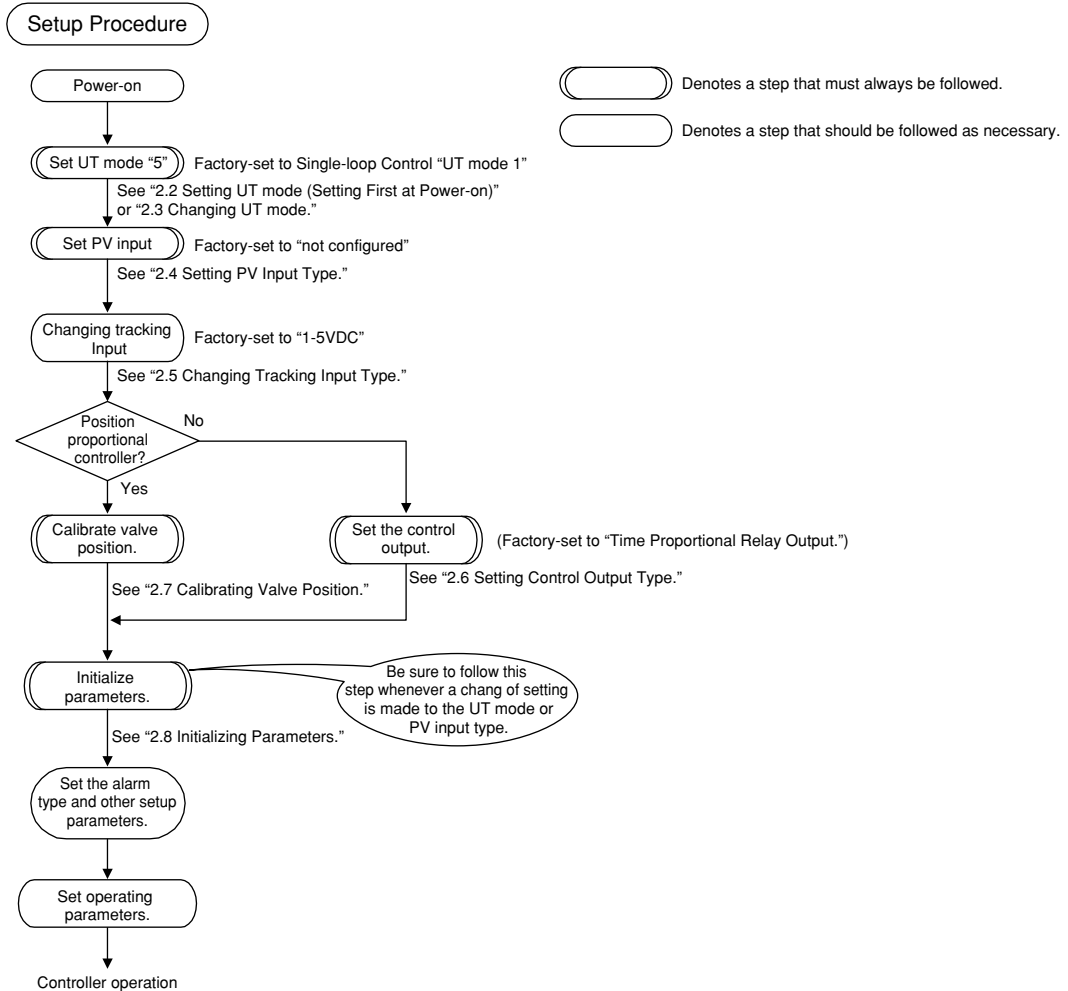

The following explanation of operation for the UT550's panel, shown in the figure, is the same as that of the UT520's panel.

2.1 Names and Functions of Front Panel Parts

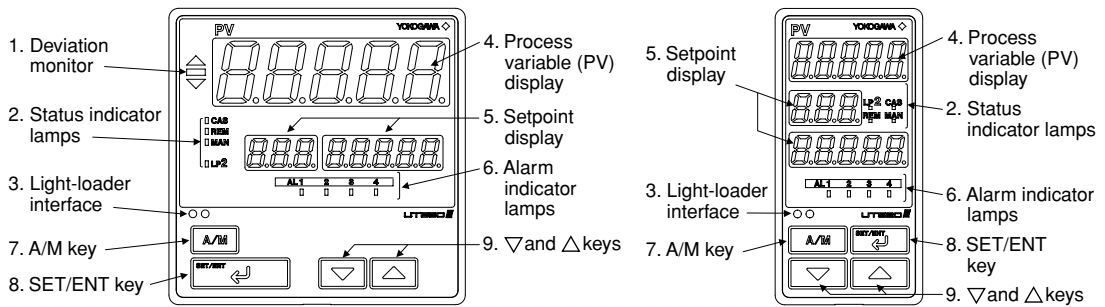

Name of Part	Function
1. Deviation monitor (for UT550 only)	<p>When lit, indicates the status of a deviation (PV - SP).</p> <p>△ : Is lit (in orange) if a deviation exceeds the deviation display range.</p> <p>□ : Is lit (in green) when a deviation is within the deviation display range.</p> <p>▽ : Is lit (in orange) if a deviation falls below the deviation display range.</p> <p>The deviation monitor goes off if any display other than the operating display or SELECT display is shown.</p>
2. Status indicator lamps	<p>Is lit (in green) to indicate the status of operation or control.</p> <p>CAS: Not used in Loop Control for Backup.</p> <p>REM: Is lit when in remote mode.</p> <p>MAN: Is lit when in manual mode.</p> <p>LP2: Not used in Loop Control for Backup.</p>
3. Light-loader interface	<p>Interface for an adapter cable used when setting and storing parameters from a PC. This requires an optional parameter setting tool.</p>
4. Process variable (PV) display	<p>Displays PV.</p> <p>Displays an error code (in red) if an error occurs.</p>
5. Setpoint display	<p>Displays a parameter symbol in 3-digit LED.</p> <p>Displays the setpoint of a parameter in 5-digit LED.</p>
6. Alarm indicator lamps	<p>If any of alarms 1 to 4 occurs, the respective alarm indicator lamp (AL1 to AL4) is lit (in orange).</p>
7. A/M key	<p>Used to switch between the AUTO and MAN modes. Each time you press the key, it switches to the AUTO or MAN mode alternately.</p>
8. SET/ENT key	<p>Used to switch or register a parameter. Pressing the key for more than 3 seconds allows you to switch between the operating display and the main menu for operating parameter setting display alternately.</p>
9. ▽ and △ keys	<p>Used to change numerical values. On setting displays for various parameters, you can change target setpoints, parameters, and output values (in manual operation). Pressing the ▽ key decreases a numerical value, while pressing the △ key causes it to increase. You can hold down a key to gradually increase the speed of change. To change from the parameter setting (operating or setup) display to the menu or from the setup parameter setting display menu to operating parameter setting display menu, press the ▽ and △ keys simultaneously.</p>

(The deviation display range can be changed using the setup parameter "DVB".)

2.2 Setting UT mode (Setting First at Power-on)

NOTE

The controller displays an operating display when the power is turned on. The submenu "IN" appears at this point if the type of PV input has not been defined yet. In this case, set a UT mode to "Loop Control for Backup", following the operating procedure described below. Then, set PV input type, control output type and others.

The following operation describes a procedure of setting a UT mode to "Loop Control for Backup". (set "5")

1. Display view at power on

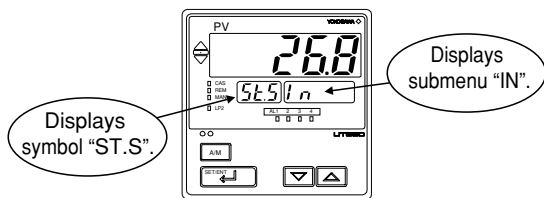

2. Press the key once to display the submenu "MD".

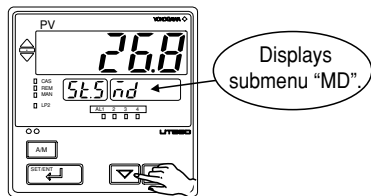

3. Press the key once to display the parameter "UTM".

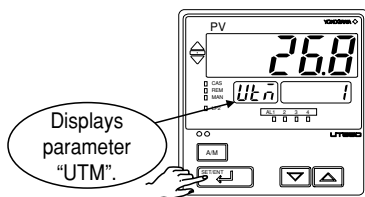

4. Press the or key to display the setpoint "5".

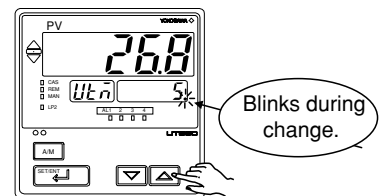

5. Press the key once to register the setpoint "5".

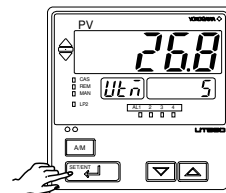

6. The controller re-starts (which is normal). Then, set PV input type. See "2.4 Setting PV Input Type."

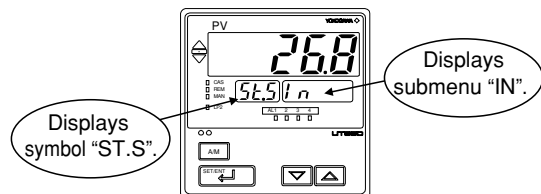

2.3 Changing UT mode

The following operation describes a procedure of changing a UT mode to "Loop Control for Backup". (set "5")

- 1. Bring the operating display into view (display appears at power-on).

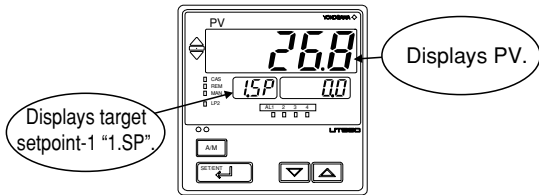

- 2. Press the key for more than 3 seconds to call up the main menu "MODE".

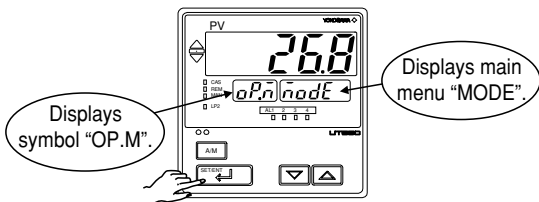

- 3. Press the key once to display the main menu "STUP".

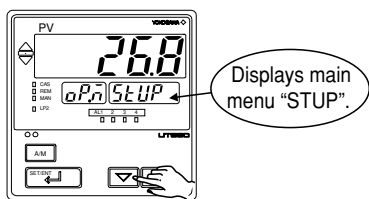

- 4. Press the key once to display the main menu "LOOP1".

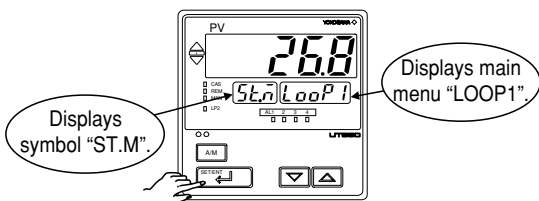

- 5. Press the key once to display the main menu "UTMD".

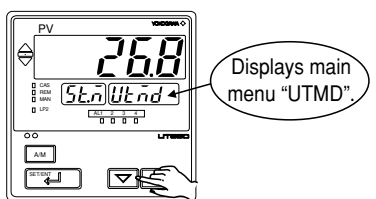

- 6. Press the key once to display the submenu "MD".

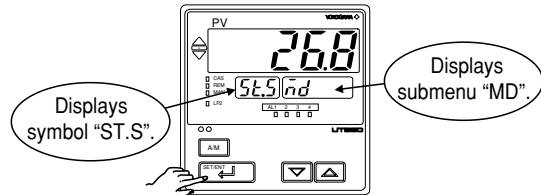

- 7. Press the key once to display the parameter "UTM".

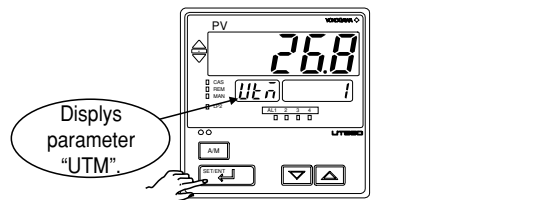

- 8. Press the or key to display the setpoint "5".

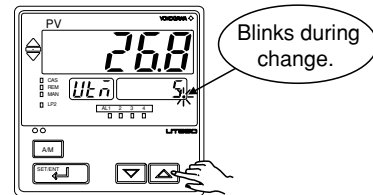

- 9. Press the key once to register the setpoint.

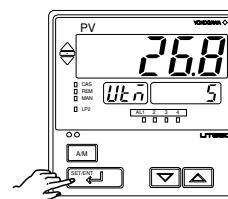

- 10. The controller re-starts (which is normal). Then, set PV input type. See "2.4 Setting PV Input Type."

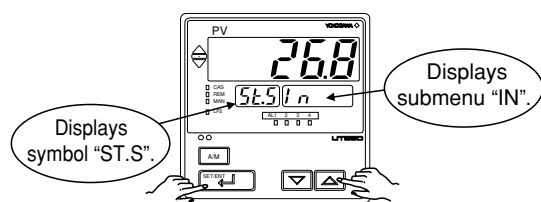

2.4 Setting PV Input Type

The following operating procedure describes an example of setting a K-type thermocouple (-200.0 to 500.0 °C) and a measurement range of 0.0 to 200 °C.

PV input terminal	
Thermocouple/mV/V input.....	⑫-⑬
RTD input	⑪-⑫-⑬

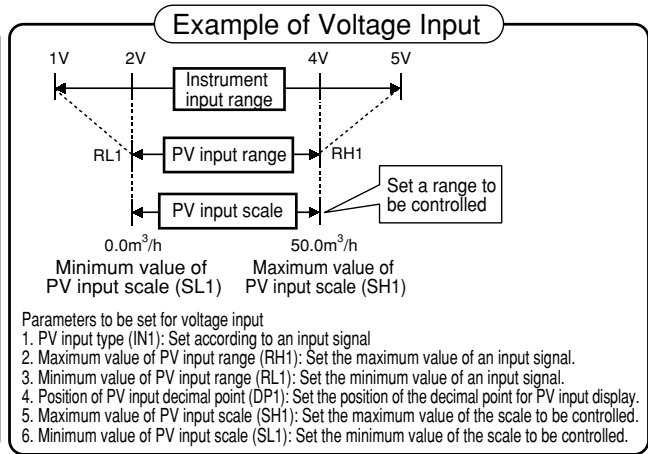
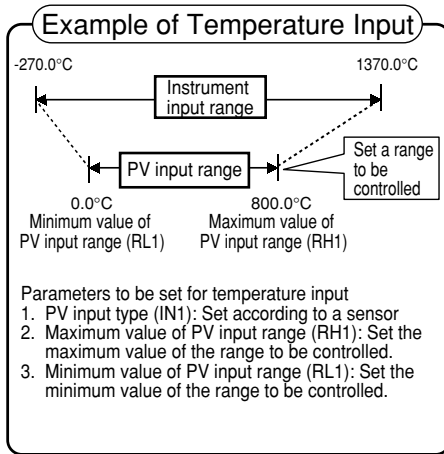

NOTE

The controller may automatically initialize the registered operating parameter setpoints if any change is made to the data item PV Input Type (IN1), Maximum Value of PV Input Range (RH1), Minimum Value of PV Input Range (RL1), PV Input Decimal Point Position (DP1), Maximum Value of PV Input Scale (SH1) or Minimum Value of PV Input Scale (SL1). After a change has been made to any of these data items, be sure to verify the registered operating parameter setpoints to ensure that they are correct. If any data item has been changed to its default, set it to a required value.

1. Bring the operating display into view (display appears at power-on).

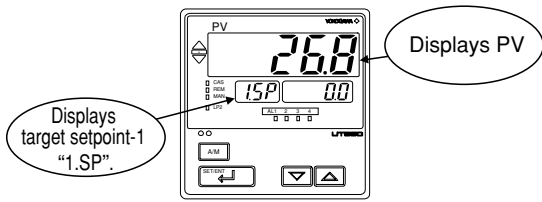

2. Press the **SET/ENT** key for more than 3 seconds to call up the main menu "MODE".

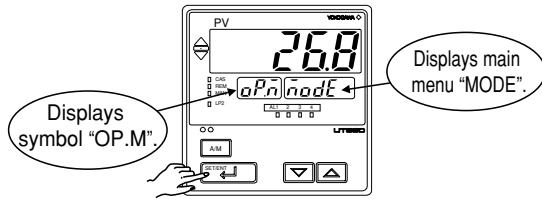

3. Press the **DOWN** key once to display the main menu "STUP".

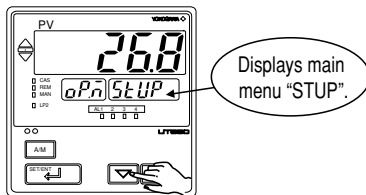

4. Press the **SET/ENT** key once to display the main menu "LOOP1".

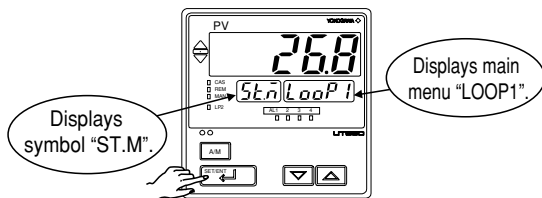

5. Press the **DOWN** key once to display the main menu "UTMD".

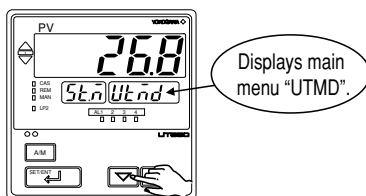

6. Press the **SET/ENT** key once to display the submenu "MD".

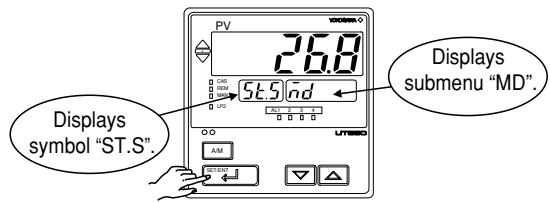

7. Press the **UP** key once to display the submenu "IN".

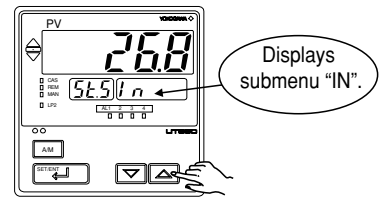

8. Press the **SET/ENT** key once to display the parameter "IN1" (PV input type).

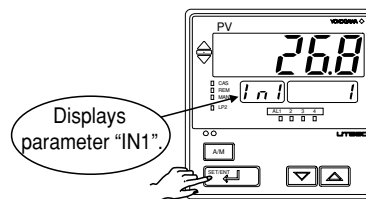

9. Press the **UP** or **DOWN** key to display the required setpoint. The figure below shows an example of setting the PV input type to a K-type thermocouple (-200.0°C to 500.0°C).

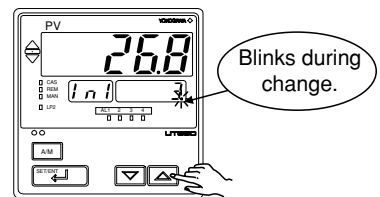

10. Press the **SET/ENT** key once to register the setpoint.

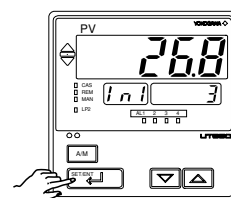

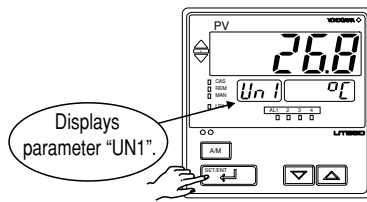

- 11. Press the  key once to display the parameter "UN1".

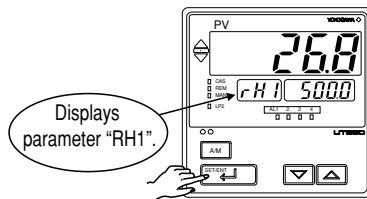

- 12. Press the  key once to display the parameter "RH1" (maximum value of PV input range).



- 13. Press the  or  key to display the required setpoint. The figure below shows an example of setting the maximum value of the PV input range to 200.0°C.

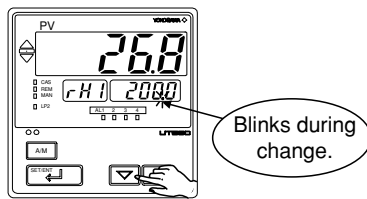

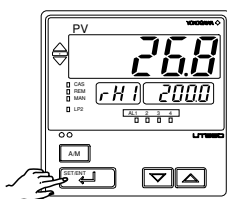

- 14. Press the  key once to register the setpoint.

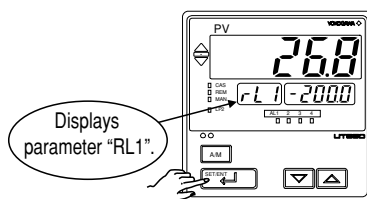

- 15. Press the  key once to display the parameter "RL1" (minimum value of PV input range).



- 16. Press the  or  key to display the required setpoint. The figure below shows an example of setting the minimum value of the PV input range to 0.0°C.

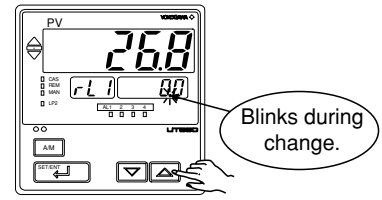

- 17. Press the  key once to register the setpoint.

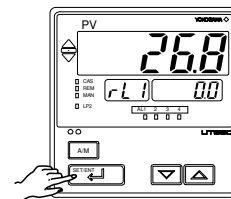

If the type of Input is voltage, also configure the PV Input Decimal Point Position (DP1), Maximum Value of PV Input Scale (SH1), and Minimum Value of PV Input Scale (SL1) parameters that follow this step.

- 18. Press the  key for more than 3 seconds. This returns you to the display shown at power-on (figure below).

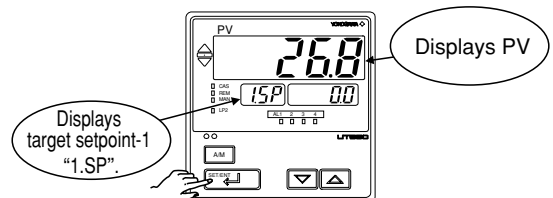

The PV display in the figure above shows the error code for input burnout (*bolit*) if PV input wiring is not yet complete. The error code disappears when you wire the PV input terminal correctly.

■ Instrument Input Range Codes

Input	Type	Instrument Input Range Code	Instrument Input Range	Measurement Accuracy	
Unspecified		OFF	Set the data item PV Input Type "IN1" to the OFF option to leave the PV input type undefined.		
Thermocouple	K	1	-270.0 to 1370.0°C -450.0 to 2500.0°F	±0.1% of instrument range ±1 digit at 0°C or more ±0.2% ±1 digit for temperatures below 0°C, where the accuracy is: ±2% of instrument range ±1 digit for temperatures below -200.0°C for a type-K thermocouple, or ±1% of instrument range ±1 digit for temperatures below -200.0°C for a type-T thermocouple.	
		2	-270.0 to 1000.0°C -450.0 to 2300.0°F		
		3	-200.0 to 500.0°C -200.0 to 1000.0°F		
	J	4	-200.0 to 1200.0°C -300.0 to 2300.0°F		
		T	5		-270.0 to 400.0°C -450.0 to 750.0°F
	6		0.0 to 400.0°C -200.0 to 750.0°F		
	B	7	0.0 to 1800.0°C 32 to 3300°F		±0.15% of instrument range ±1 digit at 400°C or more ±5% of instrument range ±1 digit at less than 400°C
	S	8	0.0 to 1700.0°C 32 to 3100°F		±0.15% of instrument range ±1 digit
	R	9	0.0 to 1700.0°C 32 to 3100°F		
	N	10	-200.0 to 1300.0°C -300.0 to 2400.0°F	±0.1% of instrument range ±1 digit ±0.25% of instrument range ±1 digit for temperatures below 0°C	
	E	11	-270.0 to 1000.0°C -450.0 to 1800.0°F	±0.1% of instrument range ±1 digit at 0°C or more ±0.2% ±1 digit for temperatures below 0°C, where the accuracy is: ±1.5% of instrument range ±1 digit for temperatures below -200.0°C for a type-E thermocouple.	
	L(DIN)	12	-200.0 to 900.0°C -300.0 to 1600.0°F		
	U(DIN)	13	-200.0 to 400.0°C -300.0 to 750.0°F		
		14	0.0 to 400.0°C -200.0 to 1000.0°F		
	W	15	0.0 to 2300.0°C 32 to 4200°F	±0.2% of instrument range ±1 digit	
	Platinel 2	16	0.0 to 1390.0°C 32.0 to 2500.0°F	±0.1% of instrument range ±1 digit	
	PR20-40	17	0.0 to 1900.0°C 32 to 3400°F	±0.5% of instrument range ±1 digit at 800°C or more No accuracy is guaranteed at less than 800°C	
	W97Re3- W75Re25	18	0.0 to 2000.0°C 32 to 3600°F	±0.2% of instrument range ±1 digit	
RTD	JPt100	30	-200.0 to 500.0°C -300.0 to 1000.0°F	±0.1% of instrument range ±1 digit (Note 1) (Note 2)	
		31	-150.00 to 150.00°C -200.0 to 300.0°F	±0.2% of instrument range ±1 digit (Note 1)	
	Pt100	35	-200.0 to 850.0°C -300.0 to 1560.0°F	±0.1% of instrument range ±1 digit (Note 1) (Note 2)	
		36	-200.0 to 500.0°C -300.0 to 1000.0°F		
		37	-150.00 to 150.00°C -200.0 to 300.0°F	±0.2% of instrument range ±1 digit (Note 1)	
Standard signal	0.4 to 2 V	40	0.400 to 2.000 V	±0.1% of instrument range ±1 digit Display range is scalable in a range of -19999 to 30000. Display span is 30000 or less.	
	1 to 5 V	41	1.000 to 5.000 V		
DC voltage	0 to 2 V	50	0.000 to 2.000 V		
	0 to 10 V	51	0.00 to 10.00 V		
	-10 to 20 mV	55	-10.00 to 20.00 mV		
	0 to 100 mV	56	0.0 to 100.0 mV		

* Performance in the standard operating conditions (at 23±2°C, 55±10%RH, and 50/60 Hz power frequency)

Note 1: The accuracy is ±0.3°C of instrument range ±1 digit for a temperature range from 0°C to 100°C.

Note 2: The accuracy is ±0.5°C of instrument range ±1 digit for a temperature range from -100°C to 200°C.

* To receive a 4-20 mA DC signal, select a standard signal of 1 to 5 V DC and connect it to a 250Ω resistor. This resistor is optional.

Model: X010-250-2 (resistor with M3.5 crimp-on terminal lugs)

2.5 Changing Tracking Input Type

The following operating procedure describes an example of changing the setting of standard signal (1 to 5VDC) to DC voltage (0 to 10 VDC).

Tracking input terminal
mV/V input..... ①-②

- 1. Bring the operating display into view (display appears at power-on).

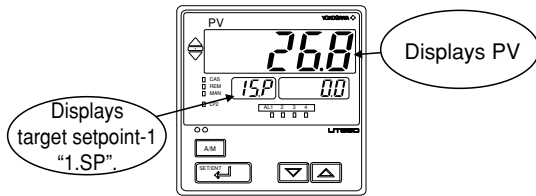

- 2. Press the **SETENT** key for more than 3 seconds to call up the main menu "MODE".

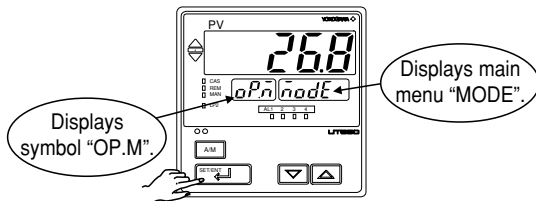

- 3. Press the **DOWN** key once to display the main menu "STUP".

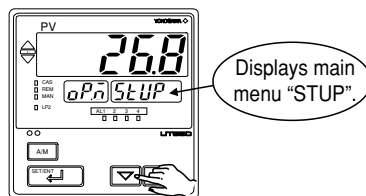

- 4. Press the **SETENT** key once to display the main menu "LOOP1".

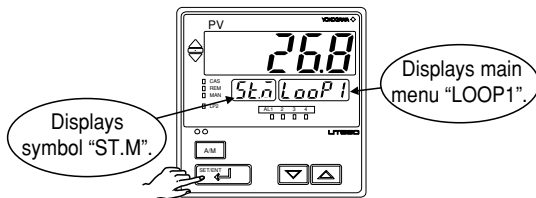

- 5. Press the **DOWN** key once to display the main menu "UTMD".

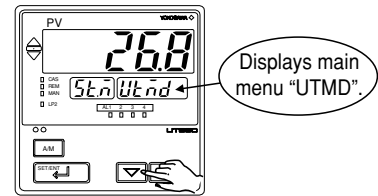

- 6. Press the **SETENT** key once to display the submenu "MD".

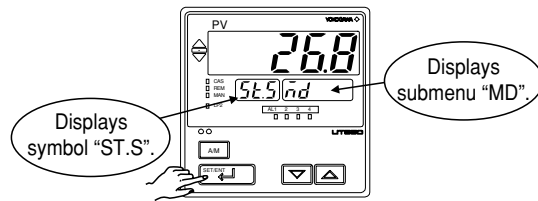

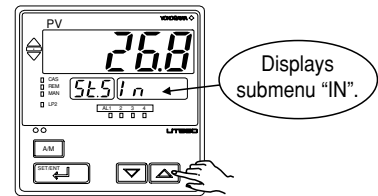

- 7. Press the **SETENT** key once to display the submenu "IN".

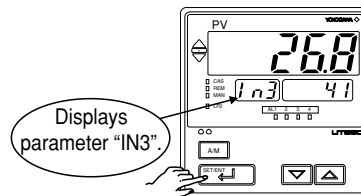

- 8. Press the **SETENT** key several times to display the parameter "IN3" (Tracking input type).



- 9. Press the  or  key to display the required setpoint. The figure below shows an example of setting a DC voltage type to 0 to 10 V DC. (set "51")

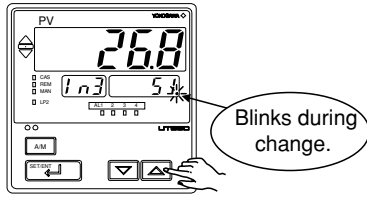

- 10. Press the  key once to register the setpoint.

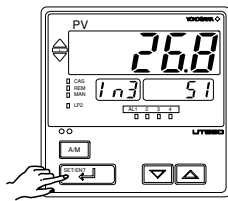

- 11. Press the  key for more than 3 seconds. This returns you to the display shown at power-on (figure below).

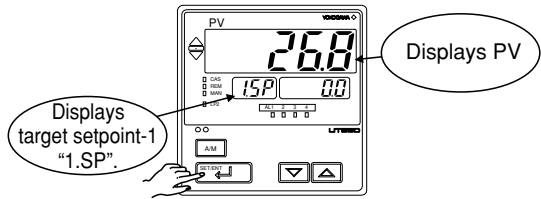

2.6 Setting Control Output Type (except for a Position Proportional Controller)

The following operating procedure describes an example of changing time proportional PID relay output (0: factory-shipped value) to continuous output (2).

Control output terminal	Values in parentheses are setpoints
Time proportional PID relay (0)/on-off(3) output.....	①-②-③
Continuous PID (2)/time proportional PID voltage pulse (1) output.....	⑩-⑪

For details on the output terminals for heating/cooling control, see "1.5 Terminal Wiring Diagrams".

- 1. Bring the operating display into view (display appears at power-on).

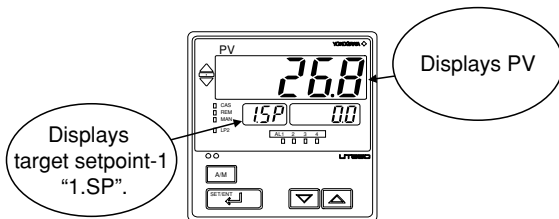

- 2. Press the  key for more than 3 seconds to call up the main menu "MODE".

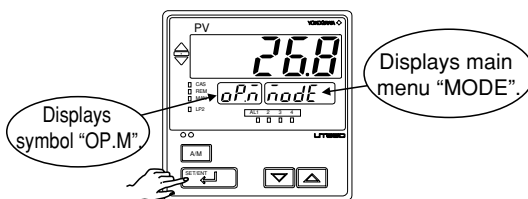

- 3. Press the  key once to display the main menu "STUP".

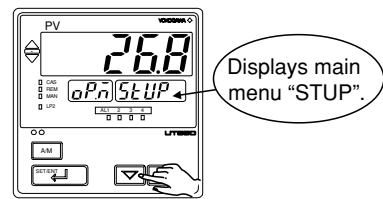

- 4. Press the  key once to display the main menu "LOOP1".

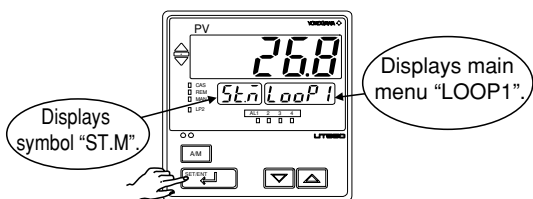

5. Press the  key once to display the main menu "UTMD".

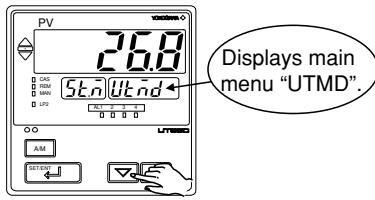

6. Press the  key once to display the submenu "MD".

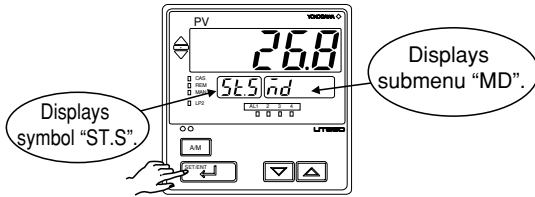

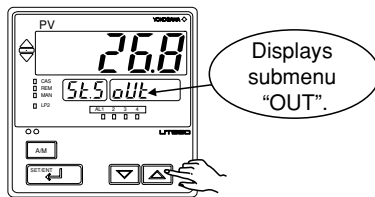

7. Press the  key twice to display the submenu "OUT".

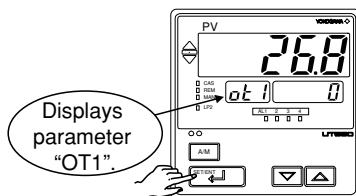

8. Press the  key once to display the parameter "OT1" (control output type).



9. Press the  or  key to display the required setpoint. The figure below shows an example of setting to continuous output (4 to 20 mA DC).

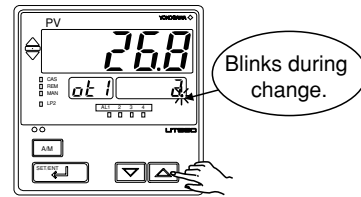

10. Press the  key once to register the setpoint.

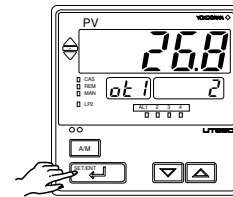

11. Press the  key for more than 3 seconds. This returns you to the display shown at power-on (figure below).

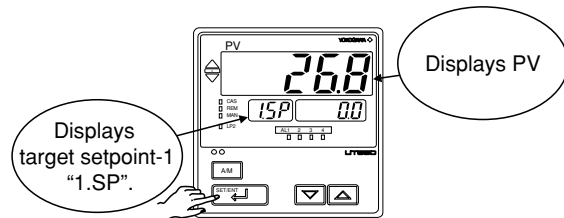

● List of Control Output Types

Parameter Symbol	Name of Parameter	Setpoint	Control Output Types	
ot 1 (OT1)	Control output type	0	Time proportional PID relay contact output (terminals ① - ② - ③)	
		1	Time proportional PID voltage pulse output (terminals ⑯ - ⑰)	
		2	Current output (terminals ⑯ - ⑰)	
		3	On/off control relay contact output (terminals ① - ② - ③)	
		The following 4 to 12 are displayed only for heating/ cooling type controllers.		
		4	Heating-side relay output (terminals ① - ② - ③), cooling-side relay output (terminals ④⑧ - ④⑨ - ⑤⑩)	
		5	Heating-side pulse output (terminals ⑯ - ⑰), cooling-side relay output (terminals ④⑧ - ④⑨ - ⑤⑩)	
		6	Heating-side current output (terminals ⑯ - ⑰), cooling-side relay output (terminals ④⑧ - ④⑨ - ⑤⑩)	
		7	Heating-side relay output (terminals ① - ② - ③), cooling-side pulse output (terminals ④⑧ - ④⑨)	
		8	Heating-side pulse output (terminals ⑯ - ⑰), cooling-side pulse output (terminals ④⑧ - ④⑨)	
		9	Heating-side current output (terminals ⑯ - ⑰), cooling-side pulse output (terminals ④⑧ - ④⑨)	
		10	Heating-side relay output (terminals ① - ② - ③), cooling-side current output (terminals ④⑧ - ④⑨)	
11	Heating-side pulse output (terminals ⑯ - ⑰), cooling-side current output (terminals ④⑧ - ④⑨)			
12	Heating-side current output (terminals ⑯ - ⑰), cooling-side current output (terminals ④⑧ - ④⑨)			

2.7 Calibrating Valve Position (for a Position Proportional Controller Only)

The following operation describes a procedure of inputting a feedback signal from a control valve to calibrate the full closed and full open positions of the valve automatically. To calibrate the valve position, you need to carry out wire connections and bring the controller into manual mode. For connections, see "1.5 Terminal Wiring Diagrams" and for entering the manual mode, see "3.8 Switching between AUTO and MAN".

1. Bring the operating display into view (display appears at power-on).

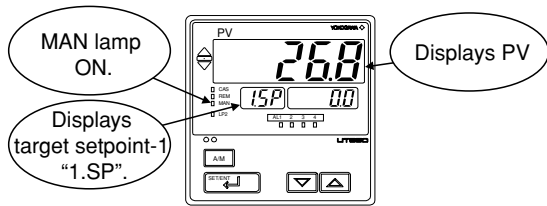

2. Press the **SET/ENT** key for more than 3 seconds to call up the main menu "MODE".

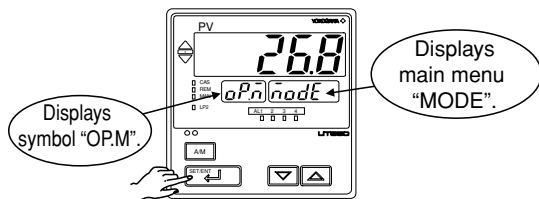

3. Press the **DOWN** key once to display the main menu "STUP".

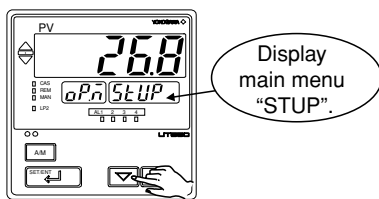

4. Press the **SET/ENT** key once to display the main menu "LOOP1".

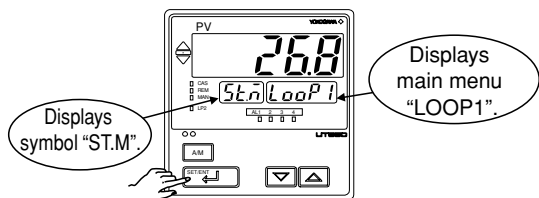

5. Press the **DOWN** key once to display the main menu "UTMD".

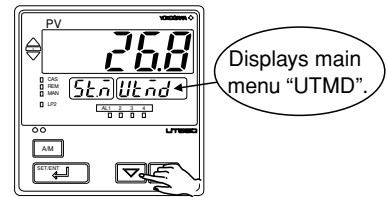

6. Press the **SET/ENT** key once to display the submenu "MD".

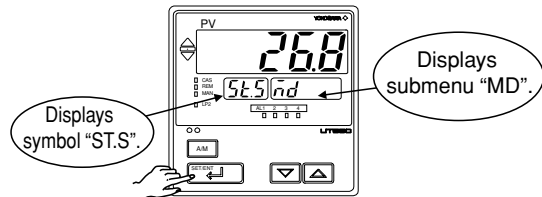

7. Press the **DOWN** key three times to display the submenu "VALV".

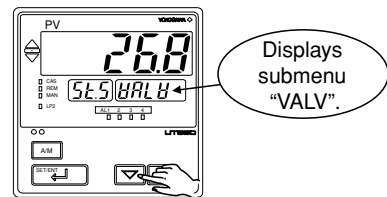

8. Press the **SET/ENT** key once to display the parameter "V.AT".

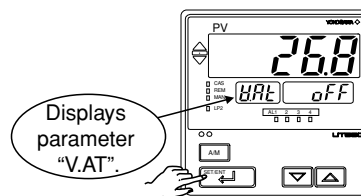

9. Press the  key to display "ON".

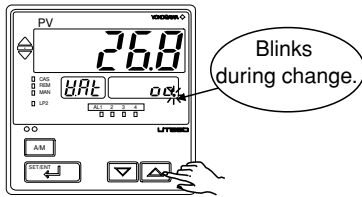

10. Press the  key once. The controller automatically calibrates the valve position (fully open or closed).

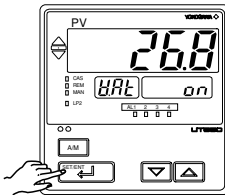

11. The controller is viewed as shown below when the valve position is being automatically calibrated.

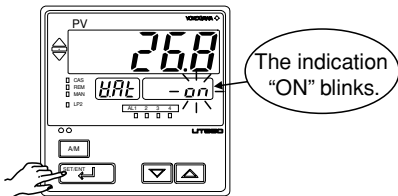

12. Calibration has ended successfully when the indication changes from "ON" to "OFF". Go to step [14].

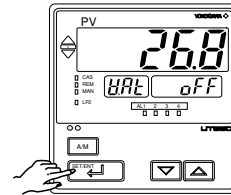

13. Calibration has ended unsuccessfully if the indication changes from "ON" to "ERR". Check the feedback input wiring and carry out automatic calibration again.

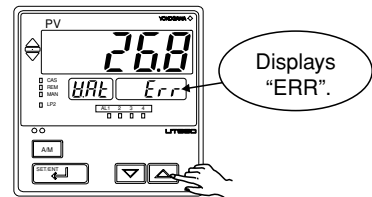

14. Press the  key for more than 3 seconds. This returns you to the display shown at power-on (figure below).

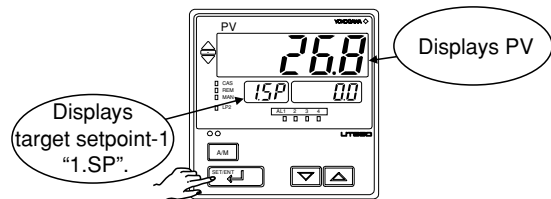

2.8 Initializing Parameters

Be sure to follow the steps below after a change of setting has been made to the data item PV Input Type, PV Input Range or PV Input Scale.

1. Bring the operating display into view (display appears at power-on).

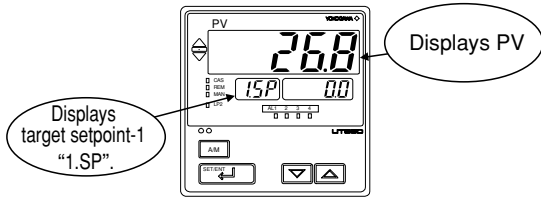

2. Press the key for more than 3 seconds to call up the main menu "MODE".

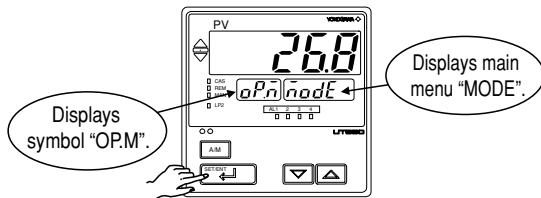

3. Press the key once to display the main menu "STUP".

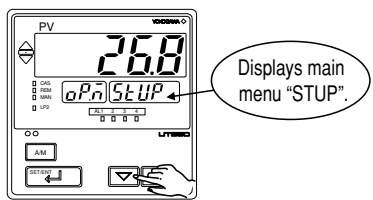

4. Press the key once to display the main menu "LOOP1".

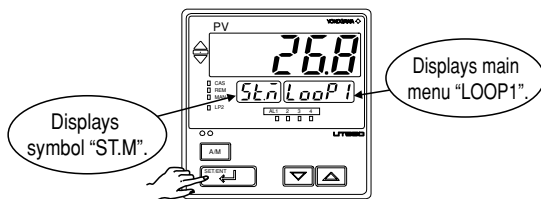

5. Press the key once to display the main menu "UTMD".

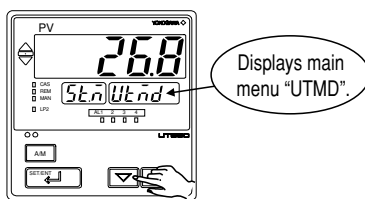

6. Press the key once to display the submenu "MD".

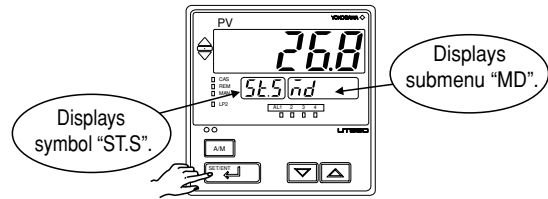

7. Press the key twice to display the submenu "INIT".

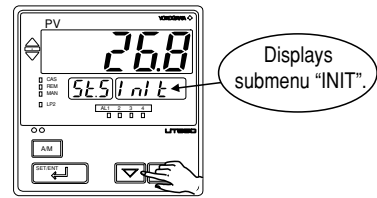

8. Press the key once to display the parameter "INI".

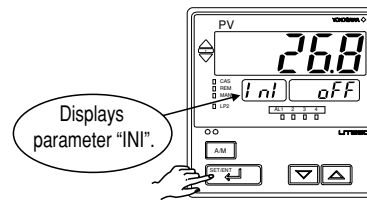

9. Press the key to display "ON".

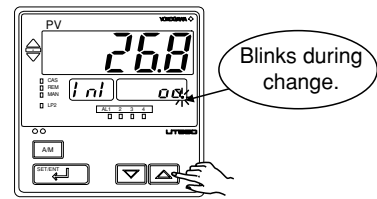

10. Press the key once. The display momentarily becomes blank (which is normal), indicating the parameters have been initialized.

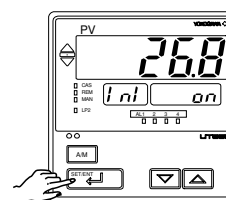

- 11. Press the  key for **more than 3 seconds**. This returns you to the display shown at power-on (figure below).

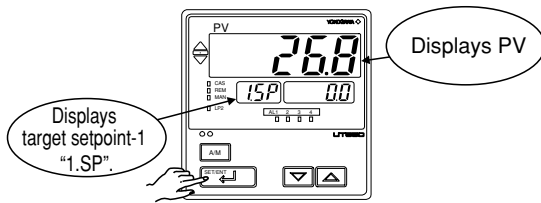



2.9 Changing Alarm Type

The following operating procedure describes an example of changing alarm 1 (factory-set to the PV high limit alarm) to the PV low limit alarm. When you have changed alarm type, the alarm setpoint will be initialized; set the alarm setpoint again.

Alarm output terminals	Factory-shipped settings
Alarm-1 (terminal numbers ⑥-⑦)	PV high limit alarm
Alarm-2 (terminal numbers ⑤-⑦)	PV low limit alarm
Alarm-3 (terminal numbers ④-⑦)	PV high limit alarm
Alarm-4 (terminal numbers ②-⑤)	PV low limit alarm

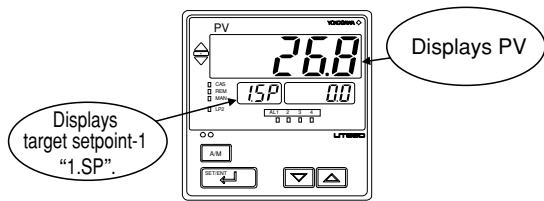
- 1. Bring the operating display into view (display appears at power-on).



- 2. Press the  key for **more than 3 seconds** to call up the main menu "MODE".

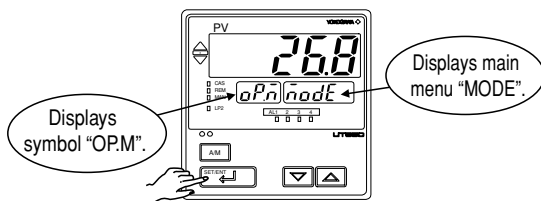

- 3. Press the  key once to display the main menu "STUP".

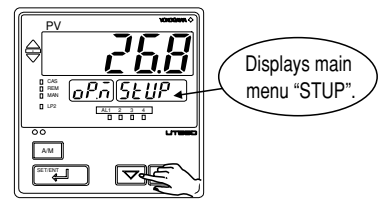

- 4. Press the  key once to display the main menu "LOOP1".

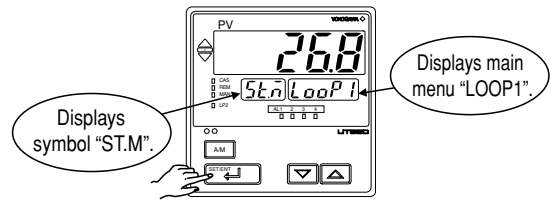

- 5. Press the  key once to display the submenu "SP".

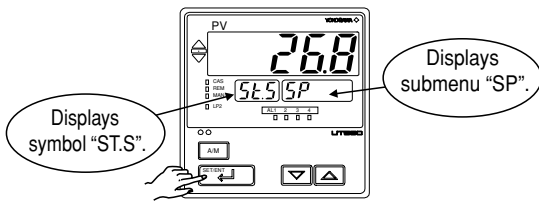

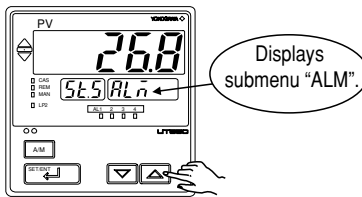

- 6. Press the  key once to display the submenu "ALM".

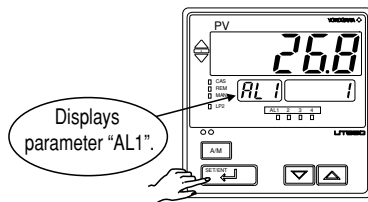

- 7. Press the  key once to display the parameter "AL1" (alarm-1 type).



- 8. Press the  or  key to display the required setpoint. The figure below shows an example of setting the PV lower-limit alarm.

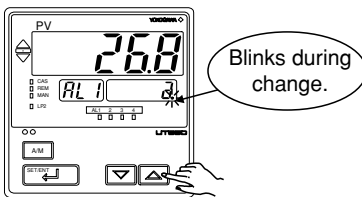

- 9. Press the  key once to register the setpoint.

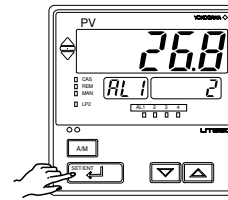

You can take the same steps for alarm-2 type (AL2), alarm-3 type (AL3), and alarm-4 type (AL4) that are displayed after this.

- 10. Press the  key for more than 3 seconds. This returns you to the display shown at power-on (figure below).

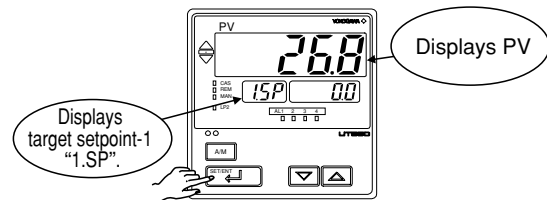

- 11. When setting alarm setpoints, see "3.5 Setting Alarm Setpoints".

List of Alarm Types

The table below shows the alarm types and alarm actions.

In the table, codes 1 to 10 are not provided with stand-by actions, while codes 11 to 20 are provided with stand-by actions.

Alarm type	Alarm action "Open/close" shows status of relay contact, and "lit" and "unlit" shows status of lamp	Alarm type code		Alarm type	Alarm action "Open/close" shows status of relay contact, and "lit" and "unlit" shows status of lamp	Alarm type code	
		Contact closes if alarm occurs	Contact opens if alarm occurs			Contact closes if alarm occurs	Contact opens if alarm occurs
No alarm		OFF					
PV high limit		1	/	De-energized on deviation low limit alarm		/	6 16
PV low limit		2	/	Deviation high and low limits		7	/
Deviation high limit		3	/	Deviation within high and low limits		8	/
Deviation low limit		4	/	De-energized on PV high limit		9	/
De-energized on deviation high limit alarm		/	5	De-energized on PV low limit		/	10 20
Timer function (Alarm-1 only)	Upward (hour/minute)	21	/	Sensor grounding alarm	Sensor grounding alarm	25	/
	Downward (hour/minute)	22	/	Fault diagnosis output (Note1)	Fault diagnosis output	26	/
	Upward (minute/second)	23	/	FAIL output (Note2)	The controller stops when in a FAIL state. The control output is set to "OFF" or "0%" and the alarm output is set to "OFF".	27	/
	Downward (minute/second)	24	/				
SP high limit		28	/	Output high limit		30	/
SP low limit		29	/	Output low limit		31	/

Note 1: The fault diagnosis output turns on in case of input burnout, A/D converter failure, or reference junction compensation (RJC) failure. For input burnout or A/D converter failure, the control output is set to the setpoint of the Preset Output Value operating parameter (PO).

Note 2: The FAIL output is on during normal operation and turns off in case of failure.

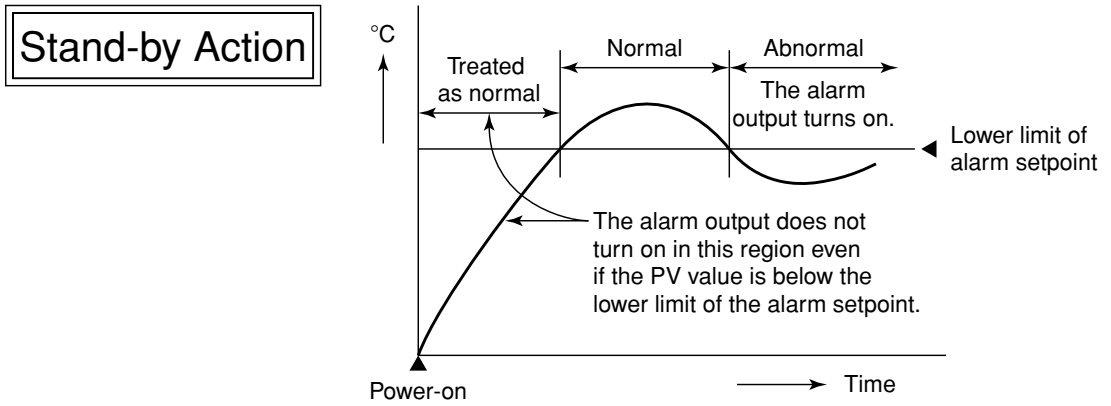

2.10 Description of Multiple Setpoints and PID

The UT550/UT520 has a maximum of eight target setpoints, and has PID for each of these setpoints. The following shows the correspondence between the target setpoint numbers (SPN), target setpoints (SP), and PID parameters.

For example, if you have set “2” to the target setpoint number (SPN), the control parameters available are target setpoint (2.SP), proportional band (heating-side proportional band) (2.P), integral time (heating-side integral time) (2.I), derivative time (heating-side derivative time) (2.D), cooling-side proportional band (2.Pc), cooling-side integral time (2.Ic), and cooling-side derivative time (2.Dc).

To use multiple target setpoints, see the table below to check the corresponding parameters.

Target setpoint number (SPN)	Target setpoint (SP)	PID parameter					
		Proportional band (heating-side proportional band)	Integral time (heating-side integral time)	Derivative time (heating-side derivative time)	Cooling-side proportional band	Cooling-side integral time	Cooling-side derivative time
SPN=1	1.SP	1.P	1.I	1.D	1.Pc	1.Ic	1.Dc
SPN=2	2.SP	2.P	2.I	2.D	2.Pc	2.Ic	2.Dc
SPN=3	3.SP	3.P	3.I	3.D	3.Pc	3.Ic	3.Dc
SPN=4	4.SP	4.P	4.I	4.D	4.Pc	4.Ic	4.Dc
SPN=5	5.SP	5.P	5.I	5.D	5.Pc	5.Ic	5.Dc
SPN=6	6.SP	6.P	6.I	6.D	6.Pc	6.Ic	6.Dc
SPN=7	7.SP	7.P	7.I	7.D	7.Pc	7.Ic	7.Dc
SPN=8	8.SP	8.P	8.I	8.D	8.Pc	8.Ic	8.Dc

3. Operations

This chapter describes key entries for operating the controller. For operations using external contact inputs, see “1.5 Terminal Wiring Diagrams”. If you cannot remember how to carry out an operation during setting, press the  key for more than 3 seconds. This brings you to the display (operating display) that appears at power-on.

3.1 Monitoring-purpose Operating Displays Available during Operation

The monitoring-purpose operating displays available during operation are roughly classified into two groups depending on the types of controller and control output. One group is operating displays for standard and position proportional controllers and the other group is operating displays for a heating/cooling controller.

■ Operating Displays for Standard and Position Proportional Controllers

● SP display

The PV input value appears on the PV display.

The target setpoint value (1.SP) appears on the Setpoint display.

● OUT Display

The PV input value appears on the PV display.

The control output value (OUT) appears on the Setpoint display.

When in position proportional control, the Setpoint display shows the valve opening (0% to 100%).

● PID Number Display

The PV input value appears on the PV display.

The PID number (PID) being used appears on the Setpoint display.

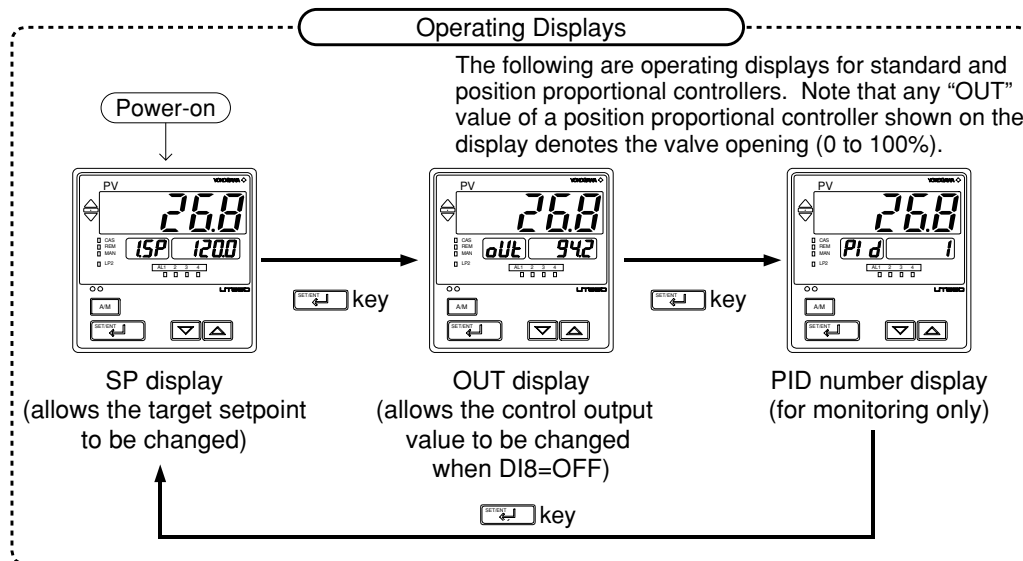

■ Operating Displays for a Heating/Cooling Controller

● SP display

The PV input value appears on the PV display.

The target setpoint value (1.SP) appears on the Setpoint display.

● Heating/Cooling OUT Display

The PV input value appears on the PV display.

The heating and cooling sides control output value (C.H) appears on the Setpoint display.

● PID Number Display

The PV input value appears on the PV display.

The PID number (PID) being used appears on the Setpoint display.

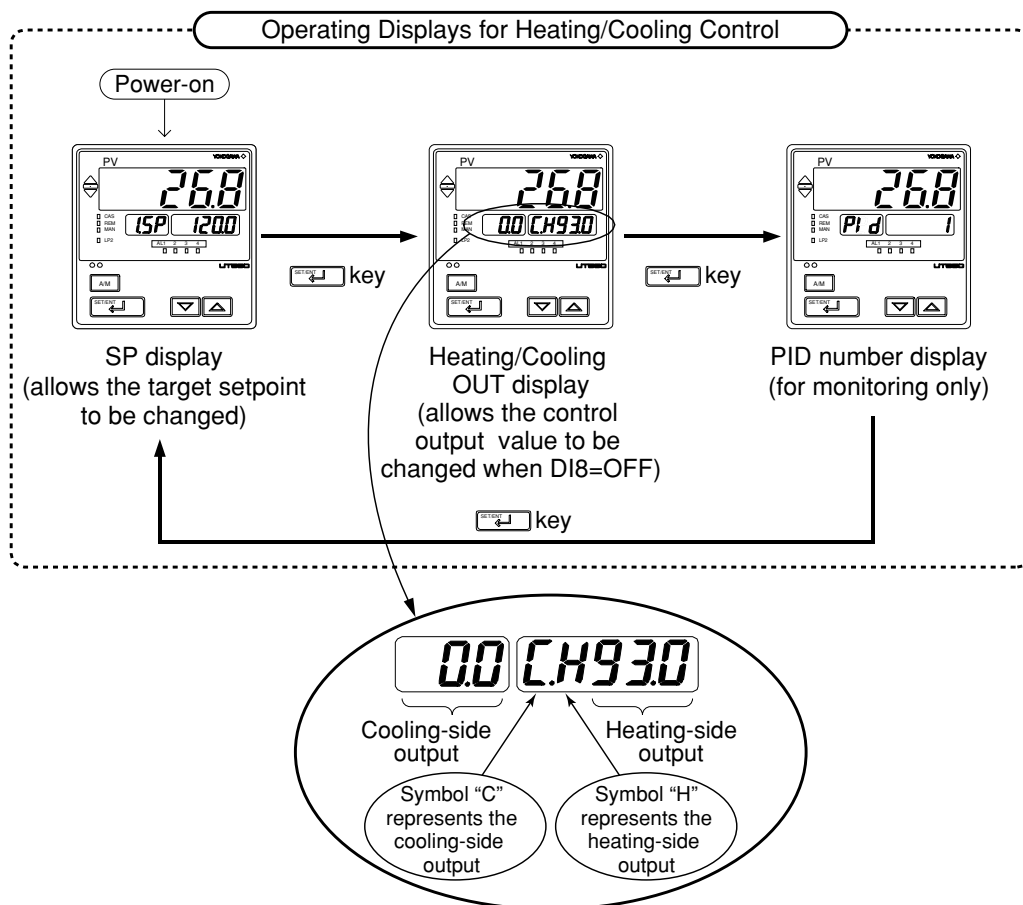



3.2 Setting Target Setpoint (SP)

The following operating procedure describes an example of setting 150.0 to a target setpoint. In automatic operation, the controller starts control using set target setpoints.

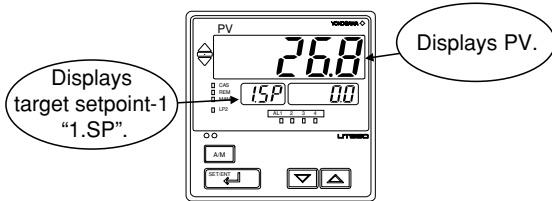
1. Bring the operating display into view (display appears at power on).



2. Press the  or  key to display the required setpoint.

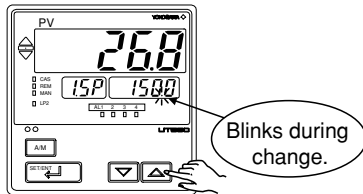

3. Press the  key once to register the value.

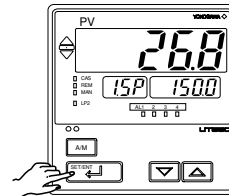

3.3 Performing/Canceling Auto-tuning

Auto-tuning should be carried out after setting a target setpoint (SP). Make sure the controller is in automatic operation mode (AUTO) and in running state (RUN) before carrying out auto-tuning. See “3.8 Switching between AUTO and MAN,” to change to AUTO and “3.7 Switching between Run and Stop,” to change to Run.

 **NOTE**

When on-off control is being used, auto-tuning cannot be carried out. Moreover, do not perform auto-tuning when controlling any of the following processes.

- Control processes with quick response such as flow control or pressure control
- Processes where even temporary output on/off results in inconvenience
- Processes where a large output change at control element results in inconvenience
- Processes where variations in PV may exceed an allowable range, adversely affecting product quality

1. Bring the operating display into view (display appears at power on).

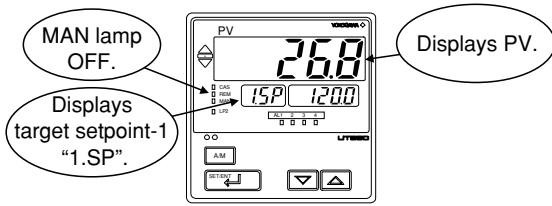

2. Press the **SET/ENT** key for more than 3 seconds to call up the main menu "MODE".

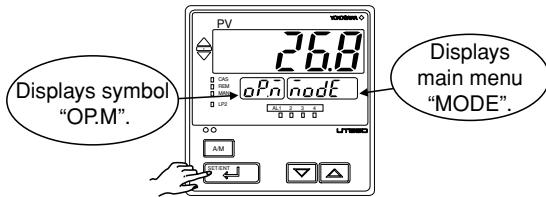

3. Press the **▲** key once to display the main menu "LP1".

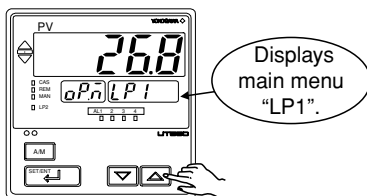

4. Press the **SET/ENT** key once to display the submenu "PAR".

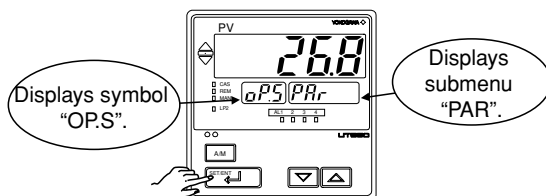

5. Press the **SET/ENT** key once again to display the parameter "AT".

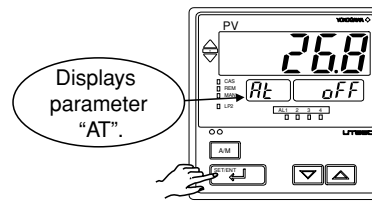

6. Press the **▲** or **▼** key to display the required setpoint. Tuning for 1.SP is AT = 1.

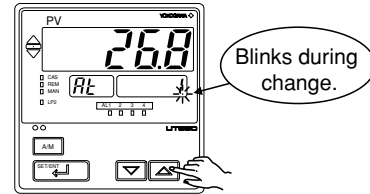

To cancel auto-tuning, set AT = OFF.

7. Press the **SET/ENT** key once to register the setpoint. (This starts auto-tuning.)
If the **SET/ENT** key is pressed when AT = OFF, auto-tuning will be cancelled. In this case, PID contains the value existing before auto-tuning.

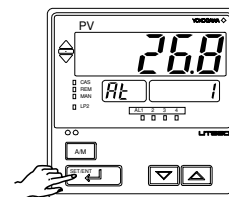

8. During auto-tuning, the panel indications become as shown below.

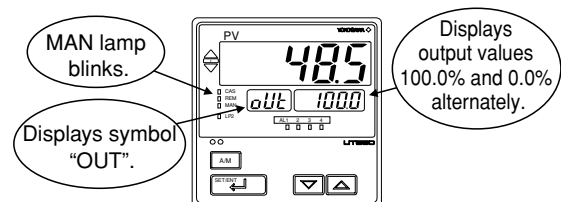

Auto-tuning is complete when the MAN lamp goes off.

3.4 Setting PID Manually

If you know the values to be set or if suitable PID constants cannot be obtained by auto-tuning, follow the procedure below to set values.

1. Bring the operating display into view (display appears at power on).

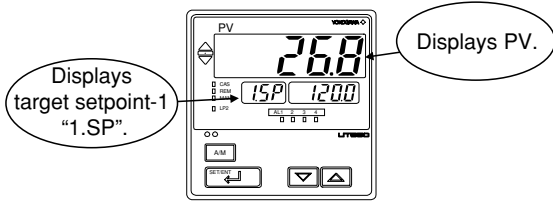

2. Press the **SET/ENT** key for more than 3 seconds to call up the main menu "MODE".

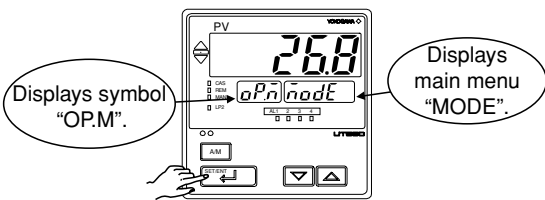

3. Press the **▲** key once to display the main menu "LP1".

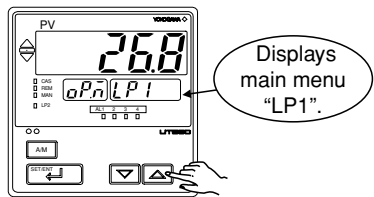

4. Press the **SET/ENT** key once to display the submenu "PAR".

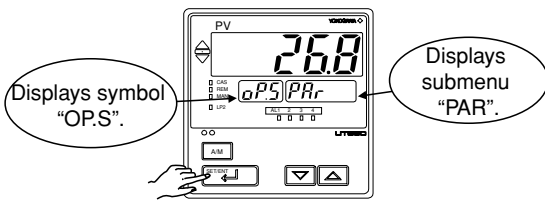

5. Press the **▲** key once to display the submenu "1.PID".

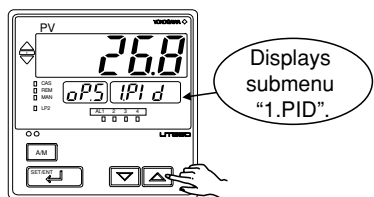

6. Press the **SET/ENT** key six times to display the parameter "1.P" (proportional band for 1.SP).

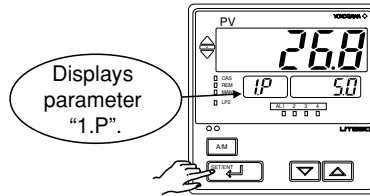

7. Press the **▲** or **▼** key to display the required setpoint.

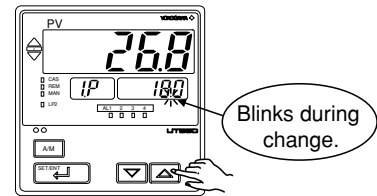

8. Press the **SET/ENT** key once to register the setpoint.

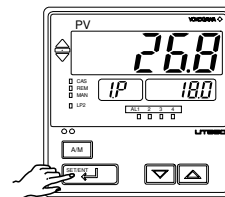

The same steps can be used for integral time (1.I), derivative time (1.D) that are displayed after this.

[TIP]

For the PID parameter number you set in step 5, select: the submenu "1.PID" if the PID constants are for 1.SP; the submenu "2.PID" if the PID constants are for 2.SP; the submenu "3.PID" if the PID constants are for 3.SP; and the submenu "4.PID" if the PID constants are for 4.SP.

9. Press the **SET/ENT** key for more than 3 seconds. This returns you to the display shown at power-on (figure below).

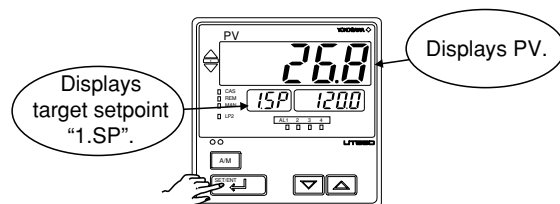

3.5 Setting Alarm Setpoints

The following operating procedure describes an example of setting 160.0 to alarm-1 setpoint. Check alarm type before setting the alarm setpoint.

When changing the alarm type, see “2.9 Changing Alarm Type.”

Alarm output terminals	Factory-shipped settings
Alarm-1 (terminal numbers ⑥-⑦)PV high limit alarm
Alarm-2 (terminal numbers ⑤-⑦)PV low limit alarm
Alarm-3 (terminal numbers ④-⑦)PV high limit alarm
Alarm-4 (terminal numbers ③-⑤)PV low limit alarm

1. Bring the operating display into view (display appears at power on).

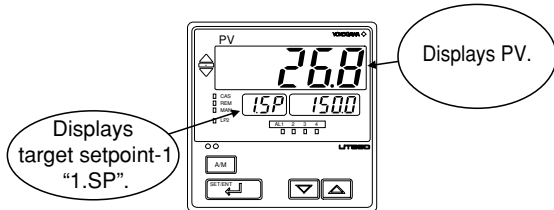

2. Press the **SET/ENT** key for more than 3 seconds to call up the main menu “MODE”.

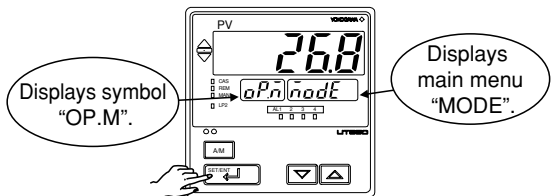

3. Press the **▲** key once to display the main menu “LP1”.

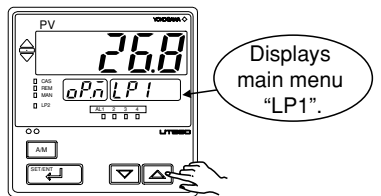

4. Press the **SET/ENT** key once to display the submenu “PAR”.

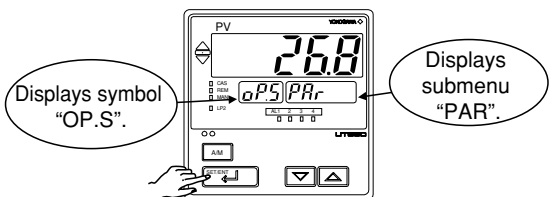

5. Press the **▲** key once to display the submenu “1.PID”.

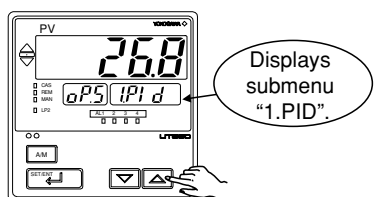

6. Press the **SET/ENT** key twice to display the parameter “1.A1”.

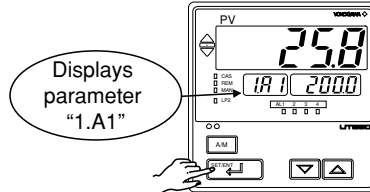

7. Press the **▲** or **▼** key to display the required setpoint.

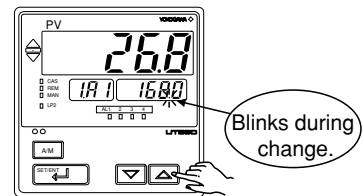

8. Press the **SET/ENT** key once to register the setpoint.

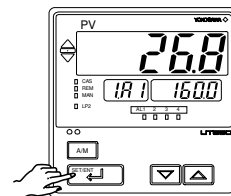

You can take the same steps for alarm-2 setpoint(1. A2), alarm-3 setpoint(1. A3), alarm-4 setpoint(1. A4) that are displayed after this.

9. Press the **SET/ENT** key for more than 3 seconds. This returns you to the display shown at power-on (figure below).

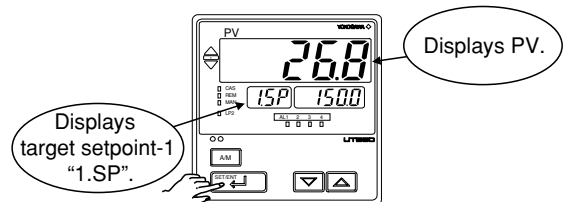

3.6 Selecting Target Setpoint Numbers (SPN)

The following operating procedure describes an example of changing a target setpoint number (SPN) from 1 to 2.

NOTE

If a target setpoint number has been switched using contact input, when the contact input is on, that number cannot be selected by keystroke.

1. Bring the operating display into view (display appears at power on).

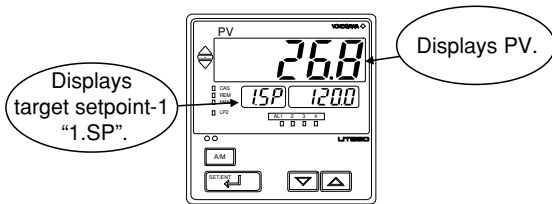

2. Press the  key for more than 3 seconds to call up the main menu "MODE".

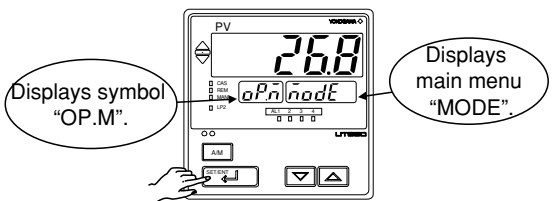

3. Press the  key several times to display the parameter "SPN".

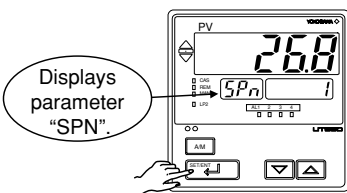

4. Press the  or  key to display the required setpoint.

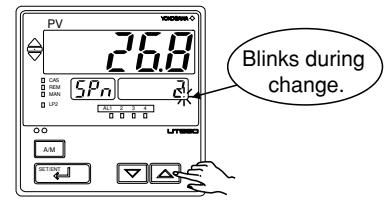

5. Press the  key once to register the setpoint.

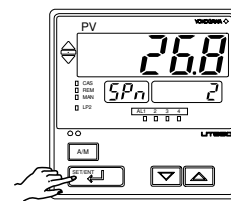

6. Press the  key for more than 3 seconds. This returns you to the display shown at power-on (figure below).

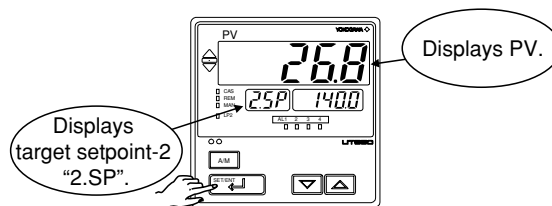

3.7 Switching between Run and Stop

Selection between the Run state (RUN) and Stop state (STOP) can be made with contact input 2 (DI2).

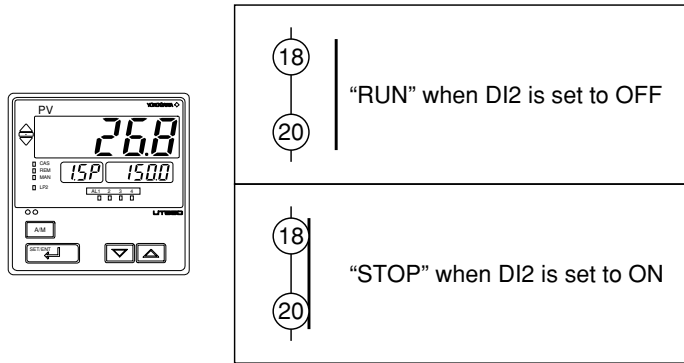

When at a stop, the controller behaves as described below:

PV input	Displays the PV value.
Control output	Provides the preset output value (factory-set to 0%).
Alarm output	Turns the output on in case of an alarm.

3.8 Switching between AUTO and MAN

NOTE

If AUTO and MAN have been switched using contact input, when the contact input is ON, switching between AUTO and MAN cannot be achieved by keystroke.

1. Bring the operating display into view (display appears at power on).

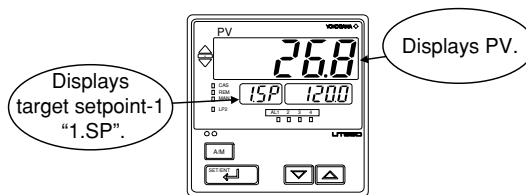

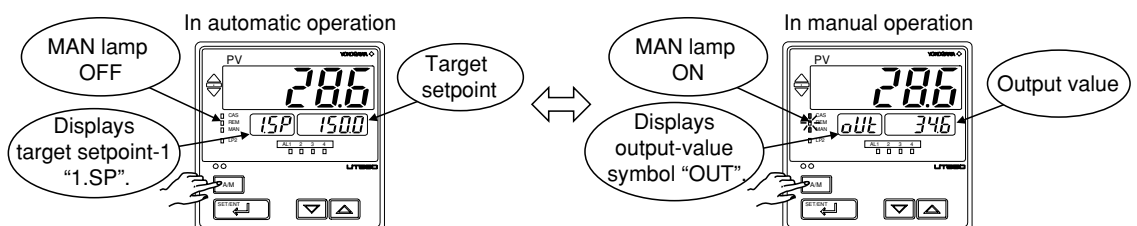

2. Each time you press the **A/M** key on the front panel of the instrument, AUTO and MAN is switched alternately.



3.9 Manipulating Control Output during Manual Operation



NOTE

- Control output cannot be changed if the controller is stopped. In this case, the preset output value (operating parameter PO) will be output.
- Control output cannot be changed when DI8=ON.

A control output value is linked with a display value changed using the  or  key. Note that the control output changes as displayed without requiring the  key.

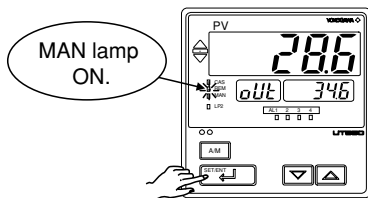
1. Bring manual operating display into view. For switching to manual operation, see “3.8 Switching between AUTO and MAN”.



2. Press the  or  key to change a control output value. You don't need to press the  key.

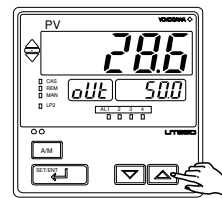

■ Manipulating the Control Output during Heating/Cooling Control

Showing the Heating/Cooling OUT display.

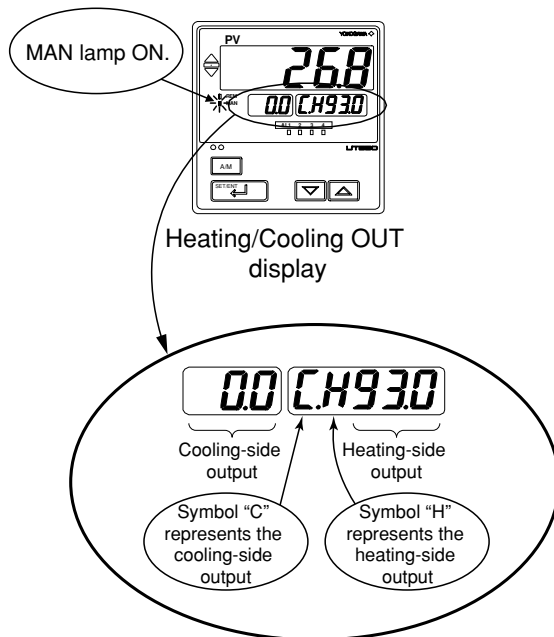



● **Controller behavior and control output manipulation when the dead band is positive**

The following is an example when the DB parameter is set at 12.4%.

If you hold down the  key with the heating-side output under manipulation (i.e., cooling-side output C = 0.0%), the heating-side output (H =) decreases.

Consequently, both the heating-side and cooling-side outputs change to 0.0%. If you keep the  key held down longer, you enter the state of manipulating the cooling-side output, and its value begins to increase.

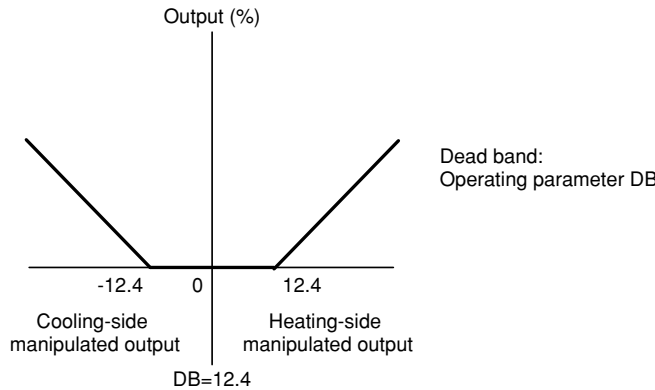

Inversely, if you hold down the  key with the cooling-side output under manipulation (i.e., heating-side output H = 0.0%), the cooling-side output (C =) decreases. Consequently, both the heating-side and cooling-side outputs go to 0.0%. If you keep the  key held down longer, you enter the state of manipulating the heating-side output, and its value begins to increase.



Change in manipulated output when the dead band is positive

● **Controller behavior and control output manipulation when the dead band is negative**

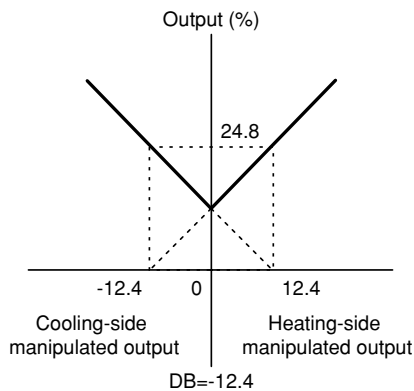

The following is an example when the DB parameter is set at -12.4%.

If you hold down the  key with the heating-side output under manipulation (i.e., cooling-side output C = 0.0%), the heating-side output (H =) decreases. If the output H falls below 24.8%, the cooling-side output C begins to increase from 0.0%. If you keep the  key held down longer and the output C rises above 24.8%, the output H goes to 0.0% and you enter the state of manipulating the cooling-side output.



Change in manipulated output when the dead band is negative

■ Manipulating the Control Output during Position Proportional Control

The controller continues to provide control output as long as the  or  key is being pressed.

 key : Closes the valve.

 key : Opens the valve.

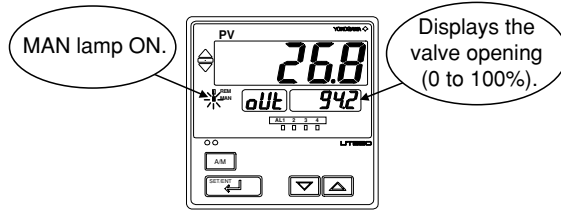

OUT display

3.10 Backup the Control Output

Selection between ON and OFF of the output tracking action can be made with contact input (DI8). The status of the contact inputs and output tracking action correspond as below.

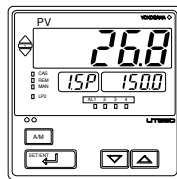

	<p>Does not hold when set OFF</p>	<p>PID calculation result of the controller will be output as the control output.</p>
	<p>Hold when set ON</p>	<p>Tracking input signal will be output as the control output.</p>

Blank Page

4. Troubleshooting and Maintenance

4.1 Troubleshooting

■ Troubleshooting Flow

If the operating display does not appear after turning on the controller's power, follow the measures in the procedure below. If a problem appears complicated, contact our sales representative.

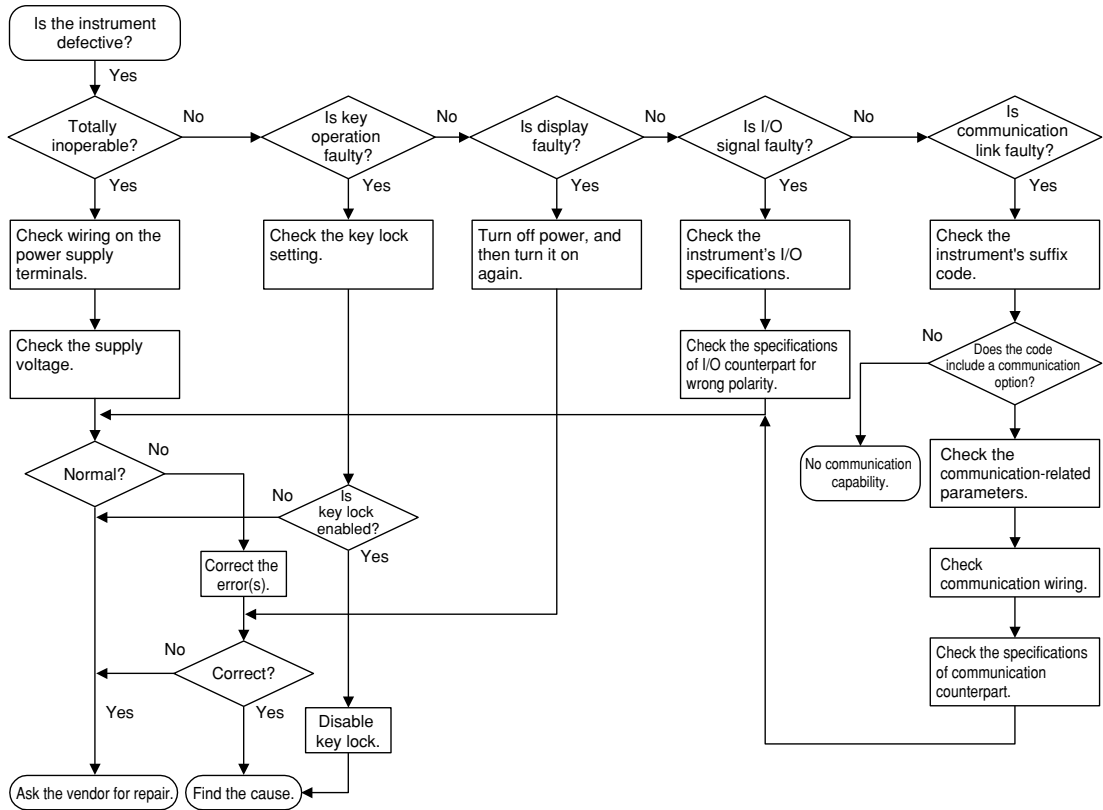

IMPORTANT

Take note of the parameter settings when asking the vendor for repair.

■ Errors at Power On

The following table shows errors that may be detected by the fault diagnosis function when the power is turned on.

Error indication (on PV display unit)	Description of error	PV	Control output	Alarm output	Retransmission output	Communication	Remedy
E000 (E000)	Faulty RAM	None	0% or less or OFF	OFF	0% or less	Stopped	Faulty Contact us for repair.
E001 (E001)	Faulty ROM			Undefined	Undefined		
E002 (E002)	System data error			Undefined	Undefined		
PV decimal point blinks. 	Faulty calibration value	Normal action (out of accuracy)	Normal action (out of accuracy)	Normal action (out of accuracy)	Normal action (out of accuracy)	Normal action	Check and set the initialized parameters.
Error code (Note) (See description below.)	Parameter error	Normal action	0% or less or OFF	Normal action	Normal action		

Note : An error code is displayed on the setpoint display unit.

An error code is displayed in the event of an error, according to its type.

An error code is a two-digit figure in which a combination of 6 bits of on and off is converted into a decimal number.

The following shows the relationship between each bit and parameter to be checked for abnormality.

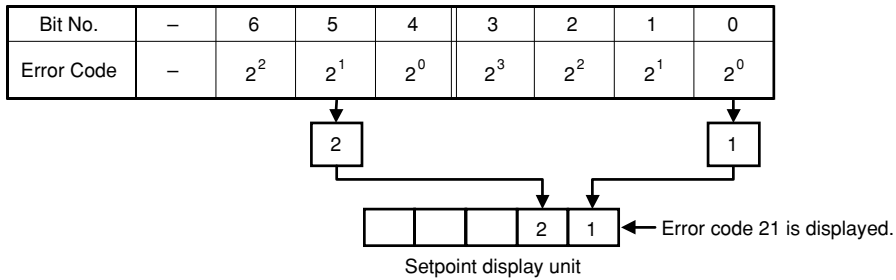

Bit No.	6	5	4	3	2	1	0
Parameter to be checked	Operation mode/output	Operating parameters	Setup parameters	Range data	-	-	Calibration data

For example, if an error occurs with the operating parameter and calibration data, the error code will be as follows:



■ Possible Errors during Operation

The following shows possible errors occurring during operations.

Error indication (on PV display unit)	Description of error	PV	Control output	Alarm output	Retransmission output	Communication	Remedy
Displays "RJC" and PV alternately	RJC error	Measured with RJC=0	Normal action				Faulty Contact us for repair.
Decimal point of item part in SP display unit blinks.	EEPROM error	Normal action					
E300 (E300)	ADC error	105%	In AUTO: Preset value output In MAN: Normal action		Normal action		Check wires and sensor.
boUt (B.OUT)	PV burnout error	Dependent on the BSL parameter Up-scale: 105% Down-scale: -5%					
oHEr (OVER) or -oHEr (-OVER)	Excessive PV Out of -5 to 105%	-5% or 105%	Normal action	Normal action		Normal action	Check process.
E200 (E200)	Auto-tuning failure (Time-out)		Action with PID existing before auto-tuning				Check process. Press any key to erase error indication.
Setpoint display 	Feedback resistor breakdown	Normal action	Stopped		Stopped		Check the feedback resistor.
Left end of SP display unit blinks.	Faulty communication line		Normal action				Check wires and communication parameters, and make resetting. Recovery at normal receipt
Decimal point at right end lights. 	Runaway (due to defective power or noise)	Undefined	0% or less or OFF	OFF	0% or less	Stopped	Faulty if power off/on does not reset start the unit. Contact us for repair.
All indications off	Power off	None					Check for abnormal power.

■ Remedies if Power Failure Occurs during Operations

The operation status and remedies after a power failure differ with the length of power failure time:

● Instantaneous power failure of 20 ms or less

A power failure is not detected. Normal operation continues.

● Power failure of about 2 seconds or less

The following show effects caused in "settings" and "operation status."

Alarm action	Continues. Alarm with standby function will enter standby status.
Setting parameter	Set contents of each parameter are retained.
Auto-tuning	Cancelled.
Control action	Action before power failure continues.

● **Power failure of more than about 2 seconds**

The following show effects caused in “settings” and “operation status.”

Alarm action	Continues. Alarm with standby function will enter standby status.	
Setting parameter	Set contents of each parameter are retained.	
Auto-tuning	Cancelled.	
Control action	Differs with setting of setup parameter “R.MD”(restart mode).	
	R.MD setting	Control action after recovery from power failure
	CONT	Action before power failure continues. (factory-shipped setting)
	MAN	Outputs preset output value (PO) as control output and continues action set before power failure in MAN mode.
	AUTO	Outputs preset output value (PO) as control output and continues action set before power failure in AUTO mode.
For heating/cooling control, preset output value is 50% of PID computation.		

■ **Troubleshooting When the Controller Fails to Operate Correctly**

If your control tasks are not successful, check the preset parameters and controller wiring before concluding the controller to be defective. The following show some examples of troubleshooting you should refer to in order to avoid the possibility of other problems.

● **The controller does not show the correct process variable (PV).**

- The UT550/UT520 controllers have a universal input. The type of PV input can be set/changed using the parameter “IN1”. At this point, the controller must be wired correctly according to the selected type of PV input. Check the wiring first if the controller fails to show the correct PV value. To do this, refer to “2. Initial Settings”. With the parameters “RH1”, “RL1”, “DP1”, “SH1” and “SL1”, it is possible to scale the input signal and change its number of decimal places. Also check that these parameters are configured correctly.

● **The controller does not provide any control output or the control output does not change at all.**

- The UT550/UT520 controllers have a universal output. The type of control output can be set/changed using the parameter “OT1”. At this point, the controller must be wired correctly according to the selected type of control output. Check the wiring first if the controller provides no control output. To do this, refer to “1.5 Terminal Wiring Diagrams”. With the parameters “OH” and “OL”, it is possible to set/change the high and low limits of control output. The control output may not change at all, however, because of restrictions on these parameters. Also check the restrictions on these parameters.
- The control output can only be changed when the controller is in the MAN mode. If the MAN lamp is off (i.e., the controller is in the AUTO mode), you cannot change the control output using key operation.

● **The control output does not change soon after the target setpoint SP has been changed.**

- If this happens, check the setpoint of the parameter “MOD”. In cases where fixed-point control is selected as the PID control mode (MOD = 1), tracking based on the I-term works to prevent the control output from changing suddenly even if the target setpoint SP is varied. The control output therefore may appear to be working incorrectly at first; however it gradually adapts itself to the new target setpoint. Be especially careful when the controller is in the fixed-point control mode; the control output may fail to change and therefore result in a loss of control if you change the target setpoint SP too frequently.

4.2 Maintenance

This section describes the cleaning and maintenance of the UT550/UT520.

4.2.1 Cleaning

The front panel and operation keys should be gently wiped with a dry cloth.



NOTE

Do not use alcohol, benzine, or any other solvents.

See Also “1.2 How to Install,” for how to replace brackets.

4.2.2 Replacing Brackets

When the brackets are broken or lost, purchase the following brackets for replacement.

Target Model	Part No.	Sales Unit
UT550	T9115NL	A large bracket and small bracket in pair
UT520	T9115NK	Two small brackets in pair

4.2.3 Attaching Terminal Cover

When a terminal cover is necessary, purchase the following part.

Target Model	Part No.	Sales Unit
UT550	T9115YD	1
UT520	T9115YE	1

■ Attaching Terminal Cover

The procedure for attaching the terminal cover is as follows.



Do not touch the terminals on the rear panel when power is being supplied to the controller. Doing so may result in electric shock. Before attaching the terminal cover, turn off the source circuit breaker and use a tester to check that the power cable is not conducting any electricity.

1. Before attaching the terminal cover, fold it once or twice so that the side which has the “Handle With Care” symbol (⚠), is on the outside.

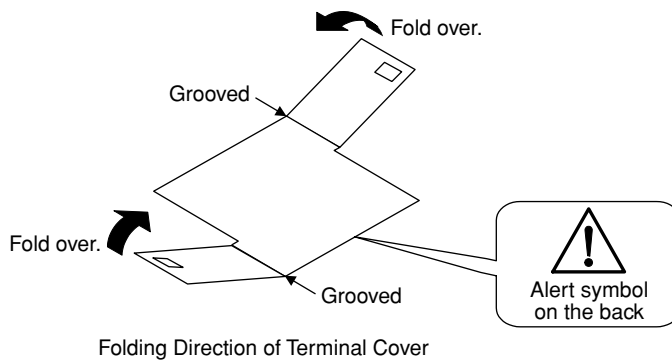

NOTE

Do not fold the terminal cover the wrong way, doing so not only reduces the cover's strength but may also cause the hinge to crack, thereby disabling attachment.

2. With the cover properly folded, fit its top and bottom holes to the protrusion of the mounting brackets.

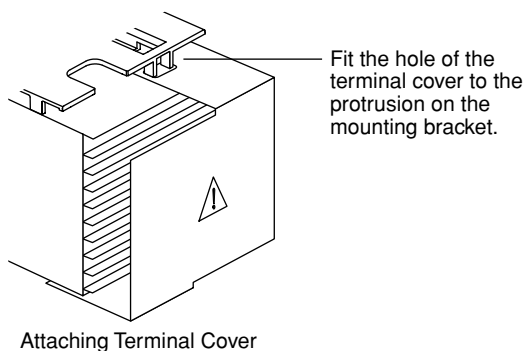

4.2.4 Replacing Parts with a Limited Service Life

The following UT550/UT520 parts have a limited service life. The service life given in the table assume that the controller is used under normal operating conditions.

Part	Service life
Aluminum electrolytic condenser	About 10 years (rated)
EEPROM	About 100,000 times of writings
Alarm output relays	About 100,000 more ON-OFF operations or with resistance load
Control output relays	About 100,000 more ON-OFF operations or with resistance load

If any of these parts, except control output relays, cause a controller failure due to deterioration, contact your dealer for replacement at your cost. Control output relays can be replaced by yourself.

See Also "4.2.5 Replacing Control Output Relays", for how to replace the control output relays.

4.2.5 Replacing Control Output Relays

This subsection describes how to replace the control output relays.
The replacement must be performed by an engineer qualified for the work.



Always turn off the power before starting the work in order to avoid electric shock.
Do not pull out the internal unit for any other purpose other than to replace the control output relays.

1. Insert a flat-blade screwdriver (tip width of 6mm is recommend) into the opening (4 openings are on the top and bottom of bezel) with the tip in parallel with the front panel, and then turn the screwdriver gently. Take this procedure to four openings 1, 2, 3, and 4 (see the figure below) on the upper and lower parts of the bezel, in order. The bezel slightly moves forward from the housing.

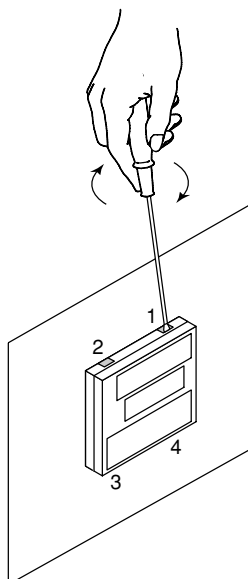

2. Push up the central part of bottom gasket of bezel by a finger to release the latch.

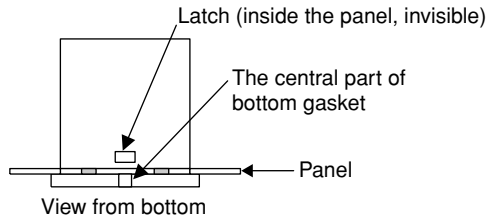

3. Insert a flat-blade screwdriver into the openings again, and complete the same procedure as step 1 to move the bezel more forward.

4. Hold the bezel and pull it along with the internal unit out of the housing.

Note: Be careful not to damage the RJC sensor.

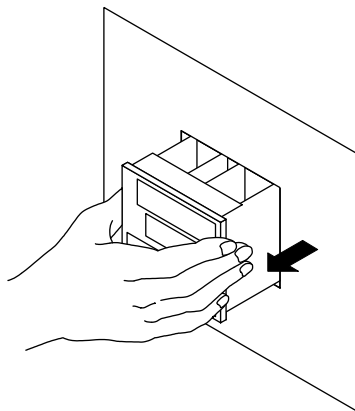

5. The location and number of the relays differ depending on the model code of the UT550/UT520. Confirm the location of the control output relay to be replaced before pulling out the relay.

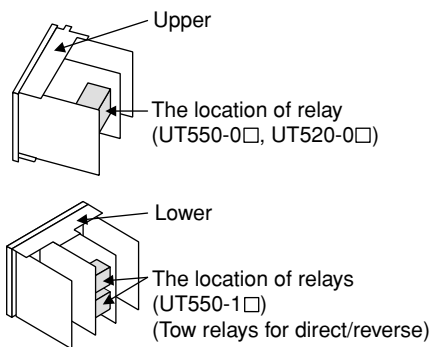

- 6. Pull out the relay to be replaced.**
The control output relays are easy to remove and mount, since they are connected via a socket onto the print boards.
Insert the new relay in the socket.
Use the following relay.

Manufacture	OMRON
Model	G6B-2114P-FD-US-P6B
Power supply	12 V DC

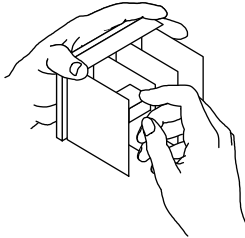

- 7. Insert the internal unit into the housing.**
Apply power to the controller and confirm that the initial operating display is shown.
If the operating display is not shown properly, turn off the controller and pull out the internal unit. Then, insert it into the housing again.

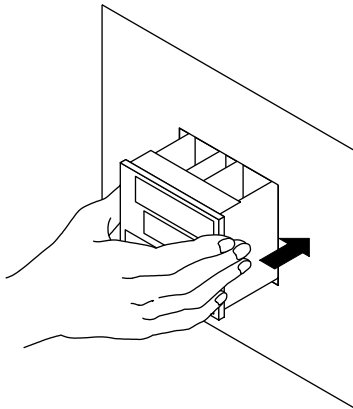

This completes replacement of the control output relay.

5. Parameters

5.1 Parameter Map

This section contains “Operating Parameter Map” and “Setup Parameter Map” for UT550/UT520 as a guideline for setting parameters.







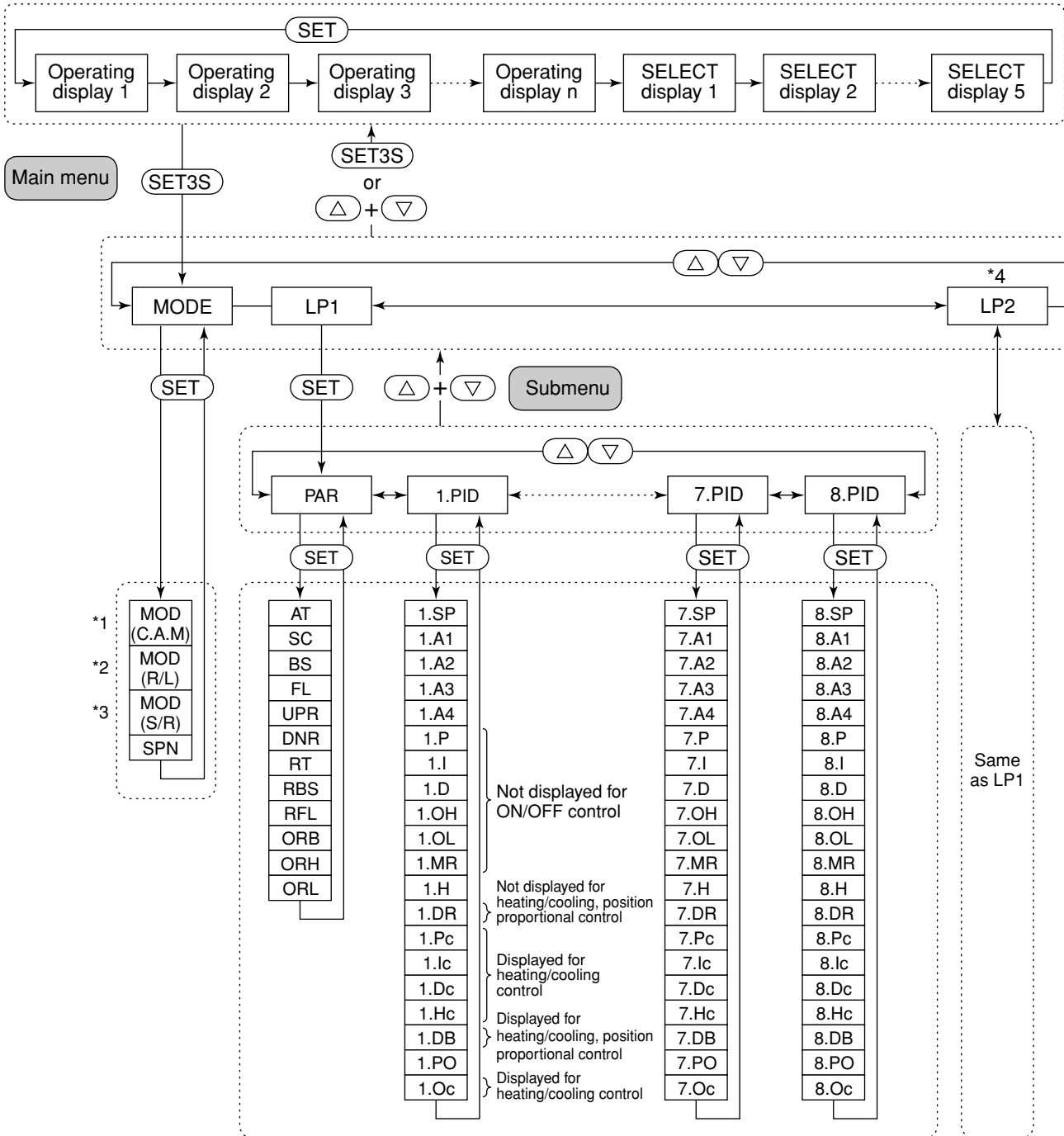



These maps helpful in finding the positions of the displays when setting the parameters, and should be used as a quick reference for the entire range of parameter displays.

UT550/UT520 Operating Parameter Map



Operating display





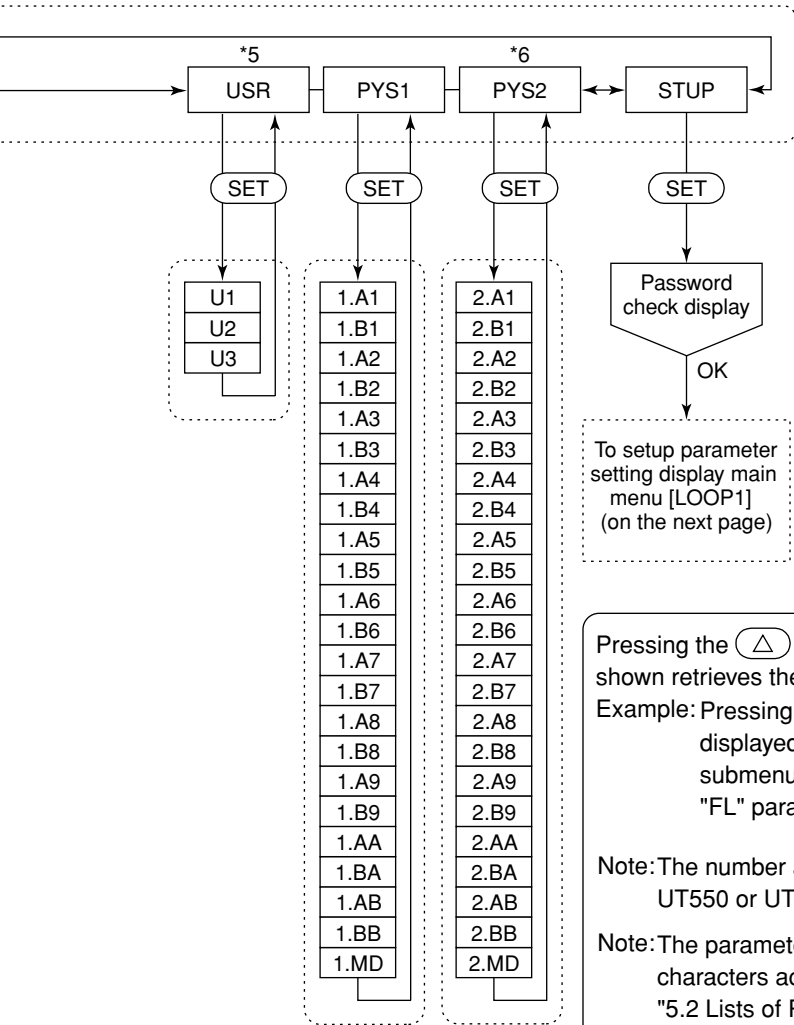

- *1 Parameter MOD (C.A.M.) is displayed when UT mode is "Cascade secondary-loop control", or "Cascade control."
- *2 Parameter MOD (R/L) is displayed only for the controller with auxiliary analog (remote) input.
- *3 Parameter MOD (S/R) is displayed when parameter S/R for registering contact input (setup parameter) is "0."
- *4 Main menu LP2 is displayed when UT mode is "Cascade control."
- *5 Main menu USR is displayed when UT mode is "Loop control with PV switching", or "Loop control with PV auto-selector."
- *6 Main menu PYS2 is displayed when UT mode is "Cascade control."

- SET : Press the  key once.
- SET3S : Press the  key for 3 seconds.
-   : Press the  or  key once.
-  +  : Press the  and  keys simultaneously.



Pressing the  +  keys once when parameter setting display is shown retrieves the menu of that parameter setting display.

Example: Pressing the  +  keys once when the [PAR] submenu is displayed, retrieves the [LP1] main menu. Conversely, the [PAR] submenu reappears by pressing the  +  keys when the "FL" parameter display subordinate to the [PAR] submenu is shown.

Note: The number and contents of operating displays differs according to the UT550 or UT520 model, the UT modes and control output types.

Note: The parameter codes of the UT550/UT520 are different from the characters actually displayed on the LED indicator. Refer to "5.2 Lists of Parameters" for the corresponding indicator characters.

SELECT display 1 to 5 are shown only when they are registered.



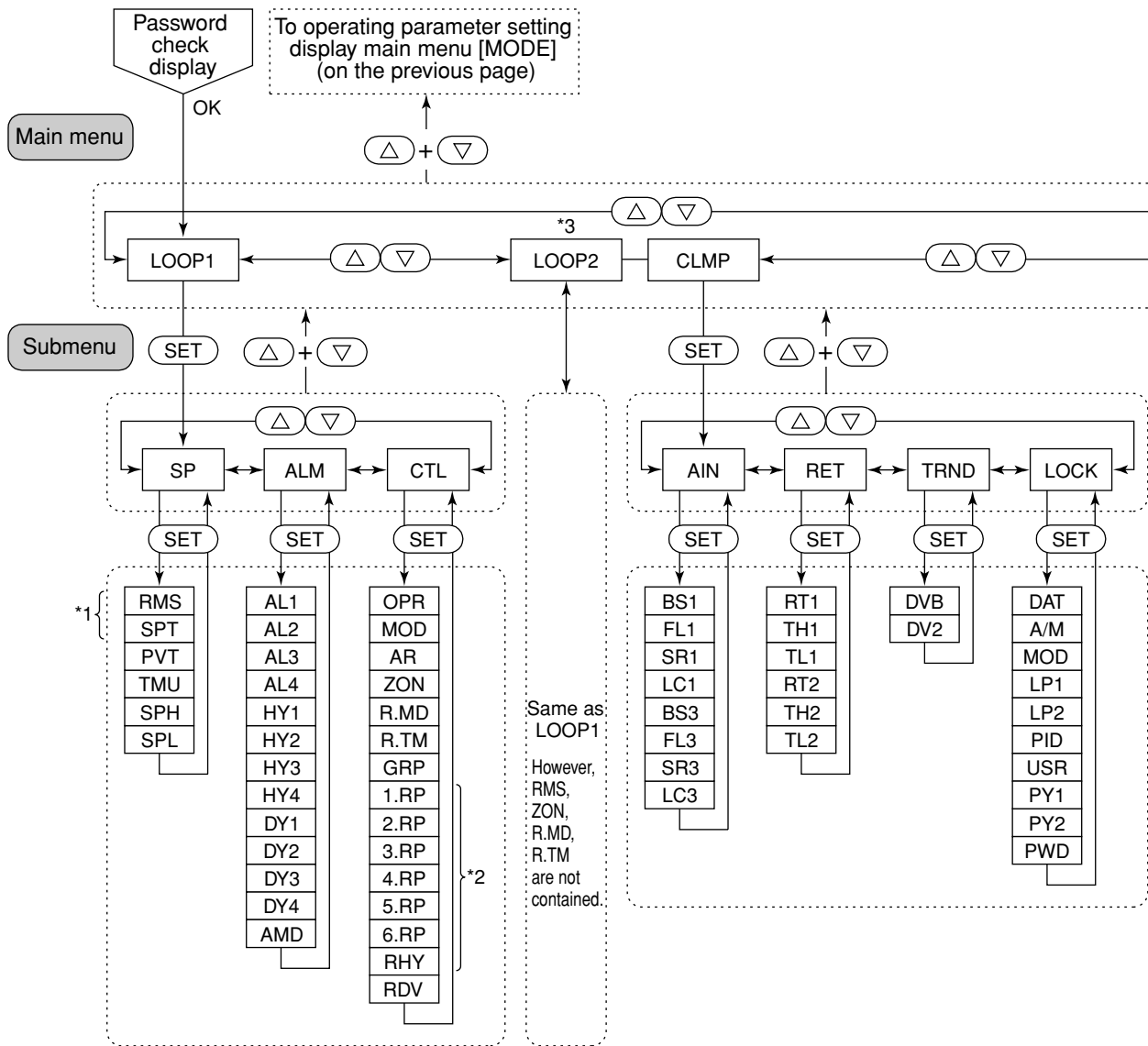

UT550/UT520 Setup Parameter Map



Pressing the $\Delta + \nabla$ keys when a parameter setting display is shown retrieves the menu of that parameter setting display.

Note: The parameter codes of the UT550/UT520 are different from the characters actually displayed on the LED indicator. Refer to "5.2 Lists of Parameters" for the corresponding indicator characters.

- *1 Parameters RMS and SPT are displayed only for the controller with auxiliary analog (remote) input.
- *2 Displayed when parameter ZON is "1."
- *3 Main menu LOOP2 is displayed when UT mode is "Cascade control."
- *4 Submenu R485 is displayed only for the controller with communication.
- *5 Submenu VALV is displayed for the position proportional controller

(SET) : Press the  key once.
 (Δ) (▽) : Press the  or  key once.
 (Δ) + (▽) : Press the  and  keys simultaneously.

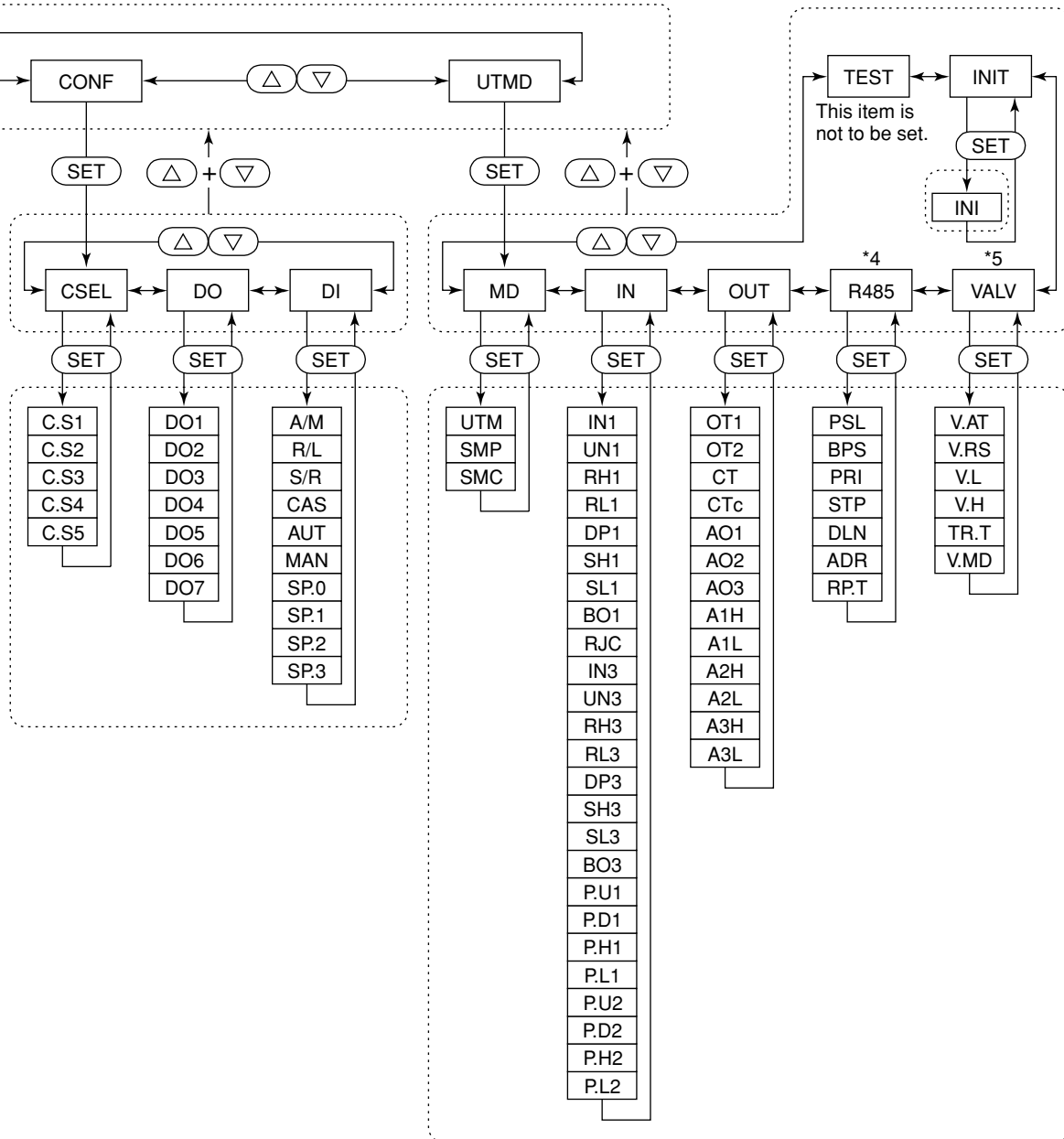

Note: The parameter items shown on the [TEST] submenu of the setup parameter display are to be used by Yokogawa service personnel to check the controller functions. Users cannot set or change these parameters.

Note: The parameter codes of the UT550/UT520 are different from the characters actually displayed on the LED indicator. Refer to "5.2 Lists of Parameters" for the corresponding indicator characters.

5.2 Lists of Parameters

This section describes the functions of parameters briefly. In addition, each parameter table has a “User Setting” column, where you can record your setpoints when setting them in the controller.

- * Parameters relating to PV or setpoints should all be set in real numbers. For example, use temperature values to define target setpoints and alarm setpoints for temperature input.
- * The “User Setting” column in the table below is provided for the customer to record setpoints.
- * Numbers in () are the parameter setpoints that apply when the communication function is used. ex. REM (1), LCL (0)

■ Operating Parameters

● Operation Mode Parameters

Located in: Main menu = *mode* (MODE)

Parameter Symbol	Name of Parameter	Setting Range and Description	Initial Value	User Setting
<i>mod</i> (MOD)	Remote/Local switching	Set to “Local” when carrying out control using the target setpoints of the controller or to “Remote” when using target setpoints acquired via a communication. REM (1): Remote mode LCL (0): Local mode	LCL (0)	
<i>mod</i> (MOD)	Run/Stop switching	Outputs the predetermined (preset) fixed value when the controller stops. A preset output value can be defined for each target setpoint using the operating parameter “PO”. Stop (1): Stops operation. Run (0): Starts operation.	RUN (0)	
<i>SPn</i> (SPN)	Target setpoint number selection	1: Selects target setpoint-1 (1.SP). 2: Selects target setpoint-2 (2.SP). 3: Selects target setpoint-3 (3.SP). 4: Selects target setpoint-4 (4.SP). Likewise, options 5 to 8 select target setpoints 5 (5.SP) to 8 (8.SP).	1	

● Operation-related Parameters

Located in: Main menu = **LP1** (LP1) ; Submenu = **PAR** (PAR)

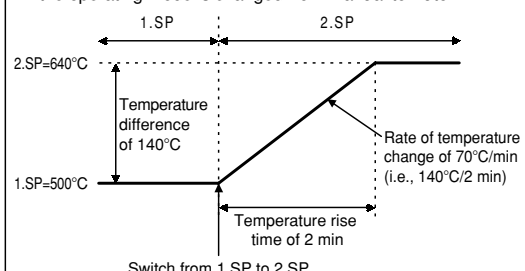
Parameter Symbol	Name of Parameter	Setting Range and Description	Initial Value	User Setting
At (AT)	Auto-tuning	OFF (0): No auto-tuning 1: Auto-tuning for 1.SP 2: Auto-tuning for 2.SP 3: Auto-tuning for 3.SP 4: Auto-tuning for 4.SP 5 to 8: Perform auto-tuning on a group basis in the same way as 1 to 4 9: Performs auto-tuning to all groups 1 to 8.	OFF (0)	
Sc (SC)	"SUPER" function	OFF (0): Disable 1: Overshoot suppressing function Suppresses overshoots generated by abrupt changes in the target setpoint or by disturbances. 2: Hunting suppressing function (Stable mode) Suitable to stabilize the state of control when the load varies greatly, or the target setpoint is changed. Enables to answer the wider characteristic changes compared with Response mode. 3: Hunting suppressing function (Response mode) Enables quick follow-up and short converging time of PV for the changed target setpoint. Note: Use "SUPER" function (SC) 2 or 3 in PID control or PI control. "SUPER" function 2 or 3 is not available in the following controls: 1) ON/OFF control 2) P control (control for proportional band only) 3) PD control (control for proportional band and derivative item only) 4) Heating/cooling control Do not use hunting suppressing function when control processes with response such as flow or pressure control.	OFF (0)	
bS (BS)	PV input bias	-100.0% to 100.0% of PV input range span Used to correct the PV input value.	0.0% of PV input range span	
FL (FL)	PV input filter	OFF (0), 1 to 120 sec Used when the PV input value fluctuates.	OFF (0)	
UPr (UPR)	Setpoint ramp-up-rate	OFF (0) 0.0% + 1 digit of PV input range span to 100.0% of PV input range span Set ramp-up-rate or ramp-down-rate per hour or minute. Sets unit in ramp-rate-time unit (TMU).	OFF (0)	
dnr (DNR)	Setpoint ramp-down-rate	Used to prevent the target setpoint from changing suddenly. The ramp setting function works when: 1. the target setpoint is changed (e.g., "1.SP" is changed from 100°C to 150°C); 2. the target setpoint number (SPN) is changed (e.g., the parameter is changed from 1.SP to 2.SP); 3. the power is turned on or has recovered from a failure; or 4. the operating mode is changed from Manual to Auto. 	OFF (0)	
rt (RT)	Ratio setting	0.001 to 9.999 Target setpoint = Remote input × Ratio setpoint + Remote bias	1.000	
rbs (RBS)	Remote input bias	-100.0 to 100.0% of PV input range span Used to correct the remote input value.	0.0% of PV input range span	
rFL (RFL)	Remote input filter	OFF (0), 1 to 120 sec. Used when the remote input value fluctuates.	OFF (0)	
orb (ORB)	ON/OFF rate detection band	0.0 to 100.0% of PV input range span	1.0% of PV input range span	
orH (ORH)	ON/OFF rate high limit	ORL + 1 digit to 105.0%	100.0 %	
orL (ORL)	ON/OFF rate low limit	-5.0% to ORH - 1 digit	0.0%	

● **Setpoint-, Alarm- and PID-related Parameters**

Located in: Main menu = **LP1** (LP1) ; Submenu = **1PID** (1.PID)

The table below lists the Target Setpoint-1 (1.SP) operating parameter and parameters that apply to the 1.SP parameter.

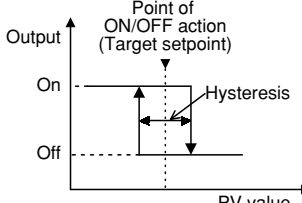
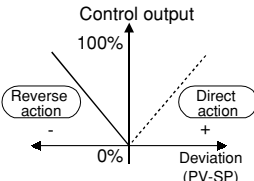
Parameter Symbol	Name of Parameter	Setting Range and Description	Initial Value	User Setting
1SP (1.SP)	Target setpoint-1	0.0 to 100.0% of PV input range However, between target setpoint limiter lower limit (SPL) and upper limit (SPH).	0.0% of PV input range	
1A1 (1.A1)	Alarm-1 setpoint	PV alarm / SP alarm: -100.0 to 100.0% of PV input range Deviation alarm: -100.0 to 100.0% of PV input range span Output alarm: -5.0 to 105.0% Timer alarm (for alarm-1 only): 0.00 to 99.99 (hour, min) or (min, sec) Allows alarms 1 to 4 (1.A1 to 1.A4) to be set for target setpoint 1 (1.SP). Four alarms can also be set for target setpoints 2 to 8.	PV high limit/SP high limit alarm: 100.0% of PV input range Deviation alarm: 0.0% of PV input range span Other PV/SP low limit alarm: 0.0% of PV input range Output high limit alarm: 100.0% Output Low limit alarm: 0.0%	
1A2 (1.A2)	Alarm-2 setpoint			
1A3 (1.A3)	Alarm-3 setpoint			
1A4 (1.A4)	Alarm-4 setpoint			
1P (1.P)	Proportional band/Heating-side proportional band (in heating/cooling control)	0.1 to 999.9% of PV input range In heating/cooling control: 0.0 to 999.9% (heating-side on/off control applies when 0.0)	5.0%	
1I (1.I)	Integral time Heating-side integral time (in heating/cooling control)	OFF (0), 1 to 6000 sec.	240 sec.	
1D (1.D)	Derivative time Heating-side derivative time (in heating/cooling control)	OFF (0), 1 to 6000 sec.	60 sec.	
1OH (1.OH)	Output high limit Heating-side output high limit (in heating/cooling control)	-5.0 to 105.0% Heating-side limiter in heating/cooling control: 0.0 to 105.0% (1.OL < 1.OH)	100% Heating/cooling control: 100.0%	
1OL (1.OL)	Output low limit Cooling-side output high limit (in heating/cooling control)	-5.0 to 105.0% Cooling-side limiter in heating/cooling control: 0.0 to 105.0% (1.OL < 1.OH) SD (shutdown): Set in manual operation in 4-20 mA control output.	0.0% Heating/cooling control: 100.0%	
1MR (1.MR)	Manual reset	-5.0 to 105.0% (enabled when integral time "1.I" is OFF) The manual reset value equals the output value when PV = SP is true. For example, if the manual reset value is 50%, the output value is 50% when PV = SP becomes true.	50.0%	
1H (1.H)	ON/OFF control hysteresis Heating-side ON/OFF control hysteresis (in heating/cooling control)	In ON/OFF control: 0.0 to 100.0% of PV input range span Position proportional PID control or heating/cooling control: 0.0 to 100.0% Hysteresis can be set in the target setpoint when the controller is performing ON/OFF control. 	ON/OFF control: 0.5% of PV input range span Position proportional PID control and heating/cooling control: 0.5%	
1DR (1.DR)	Direct/reverse action switching	RVS (0): reverse action, DIR (1): direct action 	RVS (0)	

Parameter Symbol	Name of Parameter	Setting Range and Description	Initial Value	User Setting
<i>IPc</i> (1.Pc)	Cooling-side proportional band	0.0 to 999.9% of PV input range (Cooling-side ON/OFF control applies when 0.0)	5.0%	
<i>IIc</i> (1.Ic)	Cooling-side integral time	OFF (0), 1 to 6000 sec.	240 sec.	
<i>Idc</i> (1.Dc)	Cooling-side derivative time	OFF (0), 1 to 6000 sec.	60 sec.	
<i>IHc</i> (1.Hc)	Cooling-side ON/OFF control hysteresis	0.0 to 100.0%	0.5%	
<i>ldb</i> (1.DB)	Dead band	In heating/cooling control: -100.0 to 50.0% In position proportional PID control: 1.0 to 10.0% • When performing heating/cooling control: setting any positive value prohibits both the heating and cooling outputs from turning on; setting any negative value allows both the heating and cooling outputs to turn on; and setting a value of zero either the heating or cooling output to turn on. • When performing position proportional control: set the range so none of the outputs turn on.	3.0%	
<i>IPo</i> (1.PO)	Preset output/Heating-side preset output (in heating/cooling control)	-5.0 to 105.0% In heating/cooling control: Heating side 0.0 to 105.0% In Stop mode, fixed control output can be generated.	0.0%	
<i>loc</i> (1.Oc)	Cooling-side preset output	0.0 to 105.0% In Stop mode, cooling-side fixed control output can be generated.	0.0%	

If you are using two or more groups of setpoint, alarm and PID parameters, use the following table to record their values.

Parameter	n=2	n=3	n=4	n=5	n=6	n=7	n=8
n.SP							
n.A1							
n.A2							
n.A3							
n.A4							
n.P							
n.I							
n.D							
n.OH							
n.OL							
n.MR							
n.H							
n.DR							
n.Pc							
n.Ic							
n.Dc							
n.Hc							
n.DB							
n.PO							
n.Oc							

● Ten-segment Linearizer Parameters

Located in: Main menu = **P45 1** (PYS1)

● Ten-segment linearizer biasing (factory-set default)

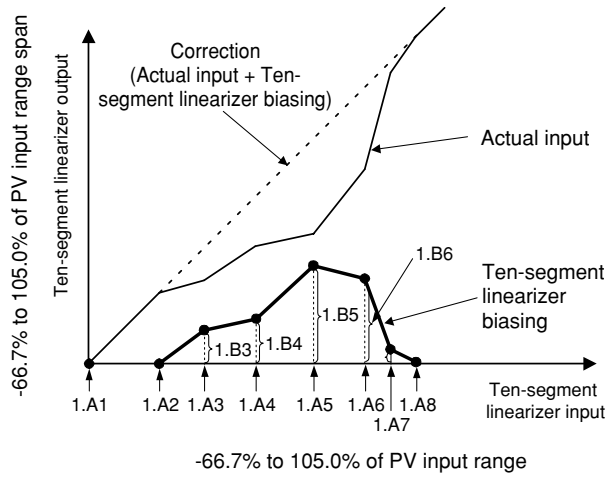

● Ten-segment linearizer approximation

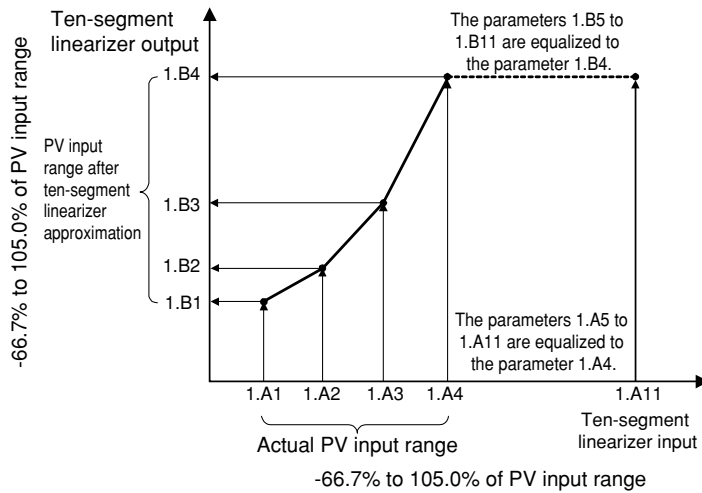

Parameter Symbol	Name of Parameter	Setting Range and Description	Initial Value	User Setting
1A1 (1.A1)	Ten-segment linearizer 1 input-1	-66.7% to 105.0% of PV input range	0.0% of PV input range	
1B1 (1.B1)	Ten-segment linearizer 1 output-1	-66.7% to 105.0% of PV input range span -66.7% to 105.0% of PV input range when in ten-segment linearizer approximation	0.0% of PV input range span 0.0% of PV input range when in ten-segment linearizer approximation	
1A2 (1.A2)	Ten-segment linearizer 1 input-2	-66.7% to 105.0% of PV input range	0.0% of PV input range	
1B2 (1.B2)	Ten-segment linearizer 1 output-2	-66.7% to 105.0% of PV input range span -66.7% to 105.0% of PV input range when in ten-segment linearizer approximation	0.0% of PV input range span 0.0% of PV input range when in ten-segment linearizer approximation	
1A3 (1.A3)	Ten-segment linearizer 1 input-3	-66.7% to 105.0% of PV input range	0.0% of PV input range	
1B3 (1.B3)	Ten-segment linearizer 1 output-3	-66.7% to 105.0% of PV input range span -66.7% to 105.0% of PV input range when in ten-segment linearizer approximation	0.0% of PV input range span 0.0% of PV input range when in ten-segment linearizer approximation	
1A4 (1.A4)	Ten-segment linearizer 1 input-4	-66.7% to 105.0% of PV input range	0.0% of PV input range	
1B4 (1.B4)	Ten-segment linearizer 1 output-4	-66.7% to 105.0% of PV input range span -66.7% to 105.0% of PV input range when in ten-segment linearizer approximation	0.0% of PV input range span 0.0% of PV input range when in ten-segment linearizer approximation	
1A5 (1.A5)	Ten-segment linearizer 1 input-5	-66.7% to 105.0% of PV input range	0.0% of PV input range	
1B5 (1.B5)	Ten-segment linearizer 1 output-5	-66.7% to 105.0% of PV input range span -66.7% to 105.0% of PV input range when in ten-segment linearizer approximation	0.0% of PV input range span 0.0% of PV input range when in ten-segment linearizer approximation	
1A6 (1.A6)	Ten-segment linearizer 1 input-6	-66.7% to 105.0% of PV input range	0.0% of PV input range	
1B6 (1.B6)	Ten-segment linearizer 1 output-6	-66.7% to 105.0% of PV input range span -66.7% to 105.0% of PV input range when in ten-segment linearizer approximation	0.0% of PV input range span 0.0% of PV input range when in ten-segment linearizer approximation	
1A7 (1.A7)	Ten-segment linearizer 1 input-7	-66.7% to 105.0% of PV input range	0.0% of PV input range	
1B7 (1.B7)	Ten-segment linearizer 1 output-7	-66.7% to 105.0% of PV input range span -66.7% to 105.0% of PV input range when in ten-segment linearizer approximation	0.0% of PV input range span 0.0% of PV input range when in ten-segment linearizer approximation	
1A8 (1.A8)	Ten-segment linearizer 1 input-8	-66.7% to 105.0% of PV input range	0.0% of PV input range	
1B8 (1.B8)	Ten-segment linearizer 1 output-8	-66.7% to 105.0% of PV input range span -66.7% to 105.0% of PV input range when in ten-segment linearizer approximation	0.0% of PV input range span 0.0% of PV input range when in ten-segment linearizer approximation	
1A9 (1.A9)	Ten-segment linearizer 1 input-9	-66.7% to 105.0% of PV input range	0.0% of PV input range	
1B9 (1.B9)	Ten-segment linearizer 1 output-9	-66.7% to 105.0% of PV input range span -66.7% to 105.0% of PV input range when in ten-segment linearizer approximation	0.0% of PV input range span 0.0% of PV input range when in ten-segment linearizer approximation	
1AA (1.AA)	Ten-segment linearizer 1 input-10	-66.7% to 105.0% of PV input range	0.0% of PV input range	
1BA (1.BA)	Ten-segment linearizer 1 output-10	-66.7% to 105.0% of PV input range span -66.7% to 105.0% of PV input range when in ten-segment linearizer approximation	0.0% of PV input range span 0.0% of PV input range when in ten-segment linearizer approximation	
1AB (1.AB)	Ten-segment linearizer 1 input-11	-66.7% to 105.0% of PV input range	0.0% of PV input range	
1BB (1.BB)	Ten-segment linearizer 1 output-11	-66.7% to 105.0% of PV input range span -66.7% to 105.0% of PV input range when in ten-segment linearizer approximation	0.0% of PV input range span 0.0% of PV input range when in ten-segment linearizer approximation	
1MD (1.MD)	Ten-segment linearizer 1 mode	0: Ten-segment linearizer biasing 1: Ten-segment linearizer approximation	0	

■ Setup Parameters

● Target Setpoint-related Parameters

Located in: Main menu = *LOOP 1* (LOOP1) ; Submenu = *SP* (SP)

Parameter Symbol	Name of Parameter	Setting Range and Description	Initial Value	User Setting
<i>rñs</i> (RMS)	Remote input selection	RSP (0): Uses the value set remotely via remote input (terminals). COM (1): Uses the value set remotely via communication.	RSP (0)	
<i>SPT</i> (SPT)	SP tracking selection	OFF (0), ON (1) Tracking is performed when the mode changes from Remote to Local (The local setpoint keeps track of the remote setpoint.)	ON (1)	
<i>PVT</i> (PVT)	PV tracking selection	Causes the setpoint to keep track of the PV value so the setpoint automatically reverts to its original value at a preset rate of change. The Setpoint Ramp-up (UPR) and Setpoint Ramp-down (DNR) parameters are used in combination. - Operating conditions - 1: Manual operation → Automatic operation; 2: Stop → Start of automatic operation; 3: Power-on; 4: Change SP number OFF (0): Disable ON (1): Enable	OFF (0)	
<i>TMU</i> (TMU)	Ramp-rate time unit setting	Time unit of setpoint ramp-up (UPR) and setpoint ramp-down (DNR) HOUR (0): Denotes "per hour." MIN (1): Denotes "per minute."	HOUR (0)	
<i>SPH</i> (SPH)	Target setpoint limiter upper limit	0.0% to 100.0% of PV input range. Note that SPL < SPH Places limits on the ranges within which the target setpoints (1.SP to 8.SP) are changed.	100.0% of PV input range	
<i>SPL</i> (SPL)	Target setpoint limiter lower limit		0.0% of PV input range	

● Alarm-related Parameters

Located in: Main menu = *LoOP 1* (LOOP1) ; Submenu = *ALn* (ALM)

Parameter Symbol	Name of Parameter	Setting Range and Description	Initial Value	User Setting
AL1 (AL1)	Alarm-1 type	OFF (0), 1 to 31 (same as below) Common to all target setpoints.	1	
AL2 (AL2)	Alarm-2 type	OFF (0), 1 to 20, 25 to 31 1: PV high limit (energized, no stand-by action) 2: PV low limit (energized, no stand-by action)	2	
AL3 (AL3)	Alarm-3 type	3: Deviation high limit (energized, no stand-by action) 4: Deviation low limit (energized, no stand-by action) 5: Deviation high limit (de-energized, no stand-by action) 6: Deviation low limit (de-energized, no stand-by action)	1	
AL4 (AL4)	Alarm-4 type	For other alarm types, see "2.9 Changing Alarm Type." Common to all target setpoints.	2	
HY1 (HY1)	Alarm-1 hysteresis	0.0 to 100.0% of PV input range span Output alarm: 0.0 to 100.0%	0.5% of PV input range span Output alarm: 0.5%	
HY2 (HY2)	Alarm-2 hysteresis	Allows margins to be set for an alarm setpoint. With the hysteresis settings, it is possible to prevent relays from chattering.		
HY3 (HY3)	Alarm-3 hysteresis			
HY4 (HY4)	Alarm-4 hysteresis			
dy1 (DY1)	Alarm-1 delay timer	0.00 to 99.59 (min, sec.) (enabled when alarm-1 type "AL1" is 1 to 20 or 28 to 31) An alarm is output when the delay timer expires after the alarm setpoint is reached.	0.00	
dy2 (DY2)	Alarm-2 delay timer	0.00 to 99.59 (min, sec.) (enabled when alarm-2 type "AL2" is 1 to 20 or 28 to 31)		
dy3 (DY3)	Alarm-3 delay timer	0.00 to 99.59 (min, sec.) (enabled when alarm-3 type "AL3" is 1 to 20 or 28 to 31)		
dy4 (DY4)	Alarm-4 delay timer	0.00 to 99.59 (min, sec.) (enabled when alarm-4 type "AL4" is 1 to 20 or 28 to 31)		
And (AMD)	Alarm mode	Allows the alarm function to be enabled or disabled according to the operating condition. 0: Always active 1: Not active when in Stop mode 2: Not active when in Stop mode or manual operation 3: Eight alarms are used and always enabled. 4: Eight alarms are used and disabled when the controller is at a stop. 5: Eight alarms are used and disabled when the controller is at a stop or in manual operation.	0	

● Control Action-related Parameters

Located in: Main menu = **LOOP 1** (LOOP1) ; Submenu = **CTL** (CTL)

Parameter Symbol	Name of Parameter	Setting Range and Description	Initial Value	User Setting
opr (OPR)	Output velocity limiter	OFF (0) 0.1 to 100.0%/sec can limit control output velocity	OFF (0)	
mod (MOD)	PID control mode	0: Standard PID control (with output bump at SP change) 1: Fixed -point control (without output bump at SP change) Choose "Fixed-point Control" when controlling pressure or flow rate.	0	
Ar (AR)	Anti-reset windup (Excess integration prevention)	AUTO (0), 50.0 to 200.0% The larger Setting, the sooner PID computation (integral computation) stops. Used when the control output travels up to 100% or down to 0% and stays at this point.	AUTO (0)	
zon (ZON)	Zone PID selection	0: SP selection 1: Zone PID If set to "SP selection," allows PID constants to be selected for each target setpoint. If set to "Zone PID," automatically selects PID constants according to the temperature range set in the given Reference Point parameter.	0	
rmd (R.MD)	Restart mode	CONT (0): Continues action set before power failure. MAN (1): Starts from manual operation status AUTO (2): Continues action set before power failure in automatic operation. Allows you to determine how the controller should recover from a power failure of longer than 2 sec.	CONT (0)	
rtm (R.TM)	Restart timer	0 to 10 sec. Sets time between power on and the instant where controller starts computation.	0 sec.	
grp (GRP)	PID group number	Allows you to determine how many groups of setpoint, alarm and PID parameters the controller should show. 1: Show one set. 2: Show two sets. 3: Show three sets. 4: Show four sets. 5 to 8: Show as many groups of parameters as have been set.	8	
1rP (1.RP)	Zone PID reference point-1	0.0 to 100.0% of PV input range. Note that $1.RP \leq 2.RP \leq 3.RP \leq 4.RP \leq 5.RP \leq 6.RP$. Sets reference points at which switching is carried out between groups of PID constants according to the given temperature zone. You can set a maximum of six reference points and therefore a maximum of seven temperature zones. To enable this parameter, set the Zone PID Selection (ZON) parameter to "1". The example below sets reference points 1 and 2 to provide 3 zones to switch PID constants automatically.	100.0% of PV input range	
2rP (2.RP)	Zone PID reference point-2			
3rP (3.RP)	Zone PID reference point-3			
4rP (4.RP)	Zone PID reference point-4			
5rP (5.RP)	Zone PID reference point-5			
6rP (6.RP)	Zone PID reference point-6			

Parameter Symbol	Name of Parameter	Setting Range and Description	Initial Value	User Setting
rHY (RHY)	Zone switching hysteresis	0.0 to 10.0% of PV input range span Allows hysteresis to be set for switching at a reference point.	0.5% of PV input range span	
rdb (RDV)	Reference deviation	<p>Used to select a group of PID parameters according to a deviation from the given target setpoint. The controller uses the PID parameters of the number selected in PID group number (GRP) if the PV input falls outside the given deviation range.</p> <p>The following example shows a case when only the reference deviation is set without setting any reference point. The selected set of PID parameters is as follows.</p> <p>Since region 1 is within the deviation range, the controller uses the 1st group of PID parameters.</p> <p>Since region 2 is outside the deviation range, the controller uses the PID parameters of the number selected in PID group number (GRP).</p> <p>OFF (0): Disable 0.0% to 100.0% of PV input range span</p>	OFF (0)	

● Analog Input Computation Parameters

Located in: Main menu = **CMLP** (CMLP) ; Submenu = **AIN** (AIN)

Parameter Symbol	Name of Parameter	Setting Range and Description	Initial Value	User Setting
b51 (BS1)	Analog input-1 bias (PV input)	Used to correct the PV input value beforehand. When in normal operation, use the PV Input Bias (BS) operating parameter. -100.0% to 100.0% of PV input range span	0.0% of PV input range span	
FL1 (FL1)	Analog input-1 filter (PV input)	OFF (0): Disable 1 to 120 sec.	OFF (0)	
SR1 (SR1)	Analog input-1 square-root computation (PV input)	Performs square-root computation for the PV input value. OFF (0): Do not compute the square root ON (1): Compute the square root	OFF (0)	
LC1 (LC1)	Analog input-1 low signal cutoff (PV input)	0.0% to 5.0% The slope equals "1" at levels below the low-signal cutoff point.	1.0%	
b53 (BS3)	Analog input-3 bias (tracking input)	Used to correct the tracking input value. -100.0% to 100.0% of tracking input range span	0.0% of PV input range span	
FL3 (FL3)	Analog input-3 filter (tracking input)	OFF (0): Disable 1 to 120 sec.	OFF (0)	
SR3 (SR3)	Analog input-3 square-root computation (tracking input)	Performs square-root computation for the tracking input value. OFF (0): Do not compute the square root ON (1): Compute the square root	OFF (0)	
LC3 (LC3)	Analog input-3 low signal cutoff (tracking input)	0.0% to 5.0% The slope equals "1" at levels below the low-signal cutoff point.	1.0%	

● Retransmission Output Parameters

Located in: Main menu = \overline{CALP} (CMLP) ; Submenu = \overline{RET} (RET)

Parameter Symbol	Name of Parameter	Setting Range and Description	Initial Value	User Setting
$\overline{RT1}$ (RT1)	Retransmission output-1 type	<p>OFF (0): Disable 1: PV1, 2: SP1, 3: OUT1, 4: LPS loop power supply (15 V), 5: PV2, 6: SP2, 7: OUT2 Setpoints 5 to 7 are not available for loop control for backup. Retransmission output 1 is always provided via terminals 14 and 15.</p> <p>In position proportional control, a valve opening signal (0% to 100%) is transmitted if setpoint "3" is selected. In heating/cooling control, an output value before allocation to heating/cooling control (0% to 100%) is transmitted if setpoint "3" is selected. (0% to 50%: Cooling-side output; 50% to 100%: Heating-side output)</p>	1	
$\overline{TH1}$ (TH1)	Maximum value of retransmission output-1 scale	<p>RT1=1, 2: TL1 + 1 digit to 100.0% of PV input range RT1=3: TL1 + 1 digit to 100.0%</p>	100.0% of PV input range	
$\overline{TL1}$ (TL1)	Minimum value of retransmission output-1 scale	<p>RT1=1, 2: 0.0% of PV input range to TH1 - 1 digit RT1=3: 0.0% to TH1 - 1 digit</p>	0.0% of PV input range	
$\overline{RT2}$ (RT2)	Retransmission output-2 type	<p>Retransmission output-2 is available when the type of control output is not "current" or "voltage pulse." The output is provided via terminals 16 and 17.</p> <p>OFF (0): Disable 1: PV1, 2: SP1, 3: OUT1, 4: LPS loop power supply (15 V), 5: PV2, 6: SP2, 7: OUT2 Setpoints 5 to 7 are not available for loop control for backup.</p> <p>In position proportional control, a valve opening signal (0% to 100%) is transmitted if setpoint "3" is selected. In heating/cooling control, an output value before allocation to heating/cooling control (0% to 100%) is transmitted if setpoint "3" is selected. (0% to 50%: Cooling-side output; 50% to 100%: Heating-side output)</p>	OFF (0)	
$\overline{TH2}$ (TH2)	Maximum value of retransmission output-2 scale	<p>RT2=1, 2: TL2 + 1 digit to 100.0% of PV input range RT2=3: TL2 + 1 digit to 100.0%</p>	100.0% of PV input range	
$\overline{TL2}$ (TL2)	Minimum value of retransmission output-2 scale	<p>RT2=1, 2: 0.0% of PV input range to TH2 - 1 digit RT2=3: 0.0% to TH2 - 1 digit</p>	0.0% of PV input range	

● **Deviation Monitor Parameters**

Located in: Main menu = *CnLP* (CMLP) ; Submenu = *trnd* (TRND)

Parameter Symbol	Name of Parameter	Setting Range and Description	Initial Value	User Setting
<i>dbb</i> (DVB)	Deviation display band	0.0 to 100.0% of PV input range span Permits a change in the span of deviation shown on the front-panel deviation monitor.	1.0% of PV input range span	

● **Security-related Parameters**

Located in: Main menu = *CnLP* (CMLP) ; Submenu = *LoLk* (LOCK)

Parameter Symbol	Name of Parameter	Setting Range and Description	Initial Value	User Setting
<i>dat</i> (DAT)	Front panel data setting (△,▽) key lock	OFF (0): Unlock ON (1): Lock	OFF (0)	
<i>am</i> (A/M)	Front panel A/M key lock	OFF (0): Unlock ON (1): Lock	OFF (0)	
<i>mod</i> (MOD)	Operating parameter main menu [MODE] lock	OFF (0): Unlock ON (1): Lock	OFF (0)	
<i>lp1</i> (LP1)	Operating parameter main menu [LP1] lock	OFF (0): Unlock ON (1): Lock	OFF (0)	
<i>lp2</i> (LP2)	Although not used in Loop Control for Backup, it is shown on the display.			
<i>pid</i> (PID)	Operating parameter main menu [PID] lock	OFF (0): Unlock ON (1): Lock	OFF (0)	
<i>usr</i> (USR)	Although not used in Loop Control for Backup, it is shown on the display.			
<i>py1</i> (PY1)	Operating parameter main menu [PYS1] lock	OFF (0): Unlock ON (1): Lock	OFF (0)	
<i>py2</i> (PY2)	Although not used in Loop Control for Backup, it is shown on the display.			
<i>pwd</i> (PWD)	Password setting	0: Password not set 1 to 30000	0	

● **SELECT Display Parameters**

Located in: Main menu = *Conf* (CONF) ; Submenu = *CSEL* (CSEL)

Parameter Symbol	Name of Parameter	Setting Range and Description	Initial Value	User Setting
<i>C51</i> (C.S1)	SELECT display-1 registration	OFF (0), 201 to 1023 Select the desired parameter from among the operating and setup parameters, then register the number (D register No.) accompanying that parameter. For example, registering "302" for C.S1 allows you to change alarm-1 setpoint in operating display. Numbers for registering alarm SP parameter for operating display: Alarm-1 setpoint: 302 Alarm-2 setpoint: 303 Alarm-3 setpoint: 304 Alarm-4 setpoint: 305 Above numbers are alarm setpoint parameters for target setpoint-1 (1.SP). Set the registration number of the alarm setpoint parameter for target setpoint 2 (2.SP), to a value obtained by adding 25 to the registration number of the alarm setpoint parameter for the parameter 1.SP. Likewise, set the registration number of the alarm setpoint parameter for target setpoint 3 (3.SP), to a value obtained by adding 25 to the registration number of the alarm setpoint parameter for the parameter 2.SP. Likewise, the registration number for 4.SP to 8.SP can be obtained.	OFF (0)	
<i>C52</i> (C.S2)	SELECT display-2 registration			
<i>C53</i> (C.S3)	SELECT display-3 registration			
<i>C54</i> (C.S4)	SELECT display-4 registration			
<i>C55</i> (C.S5)	SELECT display-5 registration			

● **Contact Output Registration Parameters**

Located in: Main menu = *Conf* (CONF) ; Submenu = *do* (DO)

Parameter Symbol	Name of Parameter	Setting Range and Description	Initial Value	User Setting
<i>do1</i> (DO1)	Relay output flag registration for DO1	The following setpoints are registration numbers for Loop Control for Backup. 5689: Alarm-1 output 5690: Alarm-2 output 5691: Alarm-3 output 5693: Alarm-4 output 1609: FAIL output	5689	
<i>do2</i> (DO2)	Relay output flag registration for DO2		5690	
<i>do3</i> (DO3)	Relay output flag registration for DO3		1611	
<i>do4</i> (DO4)	Open-collector transistor output flag registration for DO4		5693	
<i>do5</i> (DO5)	Open-collector transistor output flag registration for DO5		5691	
<i>do6</i> (DO6)	Open-collector transistor output flag registration for DO6		0	
<i>do7</i> (DO7)	Open-collector transistor output flag registration for DO7		0	

● Contact Input Registration Parameters

Located in: Main menu = *Conf* (CONF) ; Submenu = *di* (DI)

Parameter Symbol	Name of Parameter	Setting Range and Description	Initial Value	User Setting																																													
<i>Am</i> (A/M)	Auto/Manual switching	These parameters determine which contact input to use to make selections/switches listed on the left. DI1: 5161 No function: 0 DI2: 5162 DI3: 5163 DI4: 5164 DI5: 5165 DI6: 5166 DI7: 5167 DI8: 5168 The contact inputs are factory-set as shown below. Contact input 1 (DI1): Auto (ON)/Manual (OFF) switching Contact input 2 (DI2): Run (OFF)/Stop (ON) switching Contact inputs 3 to 6 (DI3 to DI6): SP selection (see table below) SP Selection: <table border="1" style="margin-left: 20px;"> <thead> <tr> <th></th> <th>1.SP</th> <th>2.SP</th> <th>3.SP</th> <th>4.SP</th> <th>5.SP</th> <th>6.SP</th> <th>7.SP</th> <th>8.SP</th> </tr> </thead> <tbody> <tr> <td>DI3</td> <td>ON</td> <td>OFF</td> <td>ON</td> <td>OFF</td> <td>ON</td> <td>OFF</td> <td>ON</td> <td>OFF</td> </tr> <tr> <td>DI4</td> <td>OFF</td> <td>ON</td> <td>ON</td> <td>OFF</td> <td>OFF</td> <td>ON</td> <td>ON</td> <td>OFF</td> </tr> <tr> <td>DI5</td> <td>OFF</td> <td>OFF</td> <td>OFF</td> <td>ON</td> <td>ON</td> <td>ON</td> <td>ON</td> <td>OFF</td> </tr> <tr> <td>DI6</td> <td>OFF</td> <td>OFF</td> <td>OFF</td> <td>OFF</td> <td>OFF</td> <td>OFF</td> <td>OFF</td> <td>ON</td> </tr> </tbody> </table> If all of the SP parameters of a contact input are set to "OFF", the controller uses the immediately preceding SP.		1.SP	2.SP	3.SP	4.SP	5.SP	6.SP	7.SP	8.SP	DI3	ON	OFF	ON	OFF	ON	OFF	ON	OFF	DI4	OFF	ON	ON	OFF	OFF	ON	ON	OFF	DI5	OFF	OFF	OFF	ON	ON	ON	ON	OFF	DI6	OFF	OFF	OFF	OFF	OFF	OFF	OFF	ON	5161	
	1.SP		2.SP	3.SP	4.SP	5.SP	6.SP	7.SP	8.SP																																								
DI3	ON		OFF	ON	OFF	ON	OFF	ON	OFF																																								
DI4	OFF		ON	ON	OFF	OFF	ON	ON	OFF																																								
DI5	OFF		OFF	OFF	ON	ON	ON	ON	OFF																																								
DI6	OFF		OFF	OFF	OFF	OFF	OFF	OFF	ON																																								
<i>rl</i> (R/L)	Remote/Local switching		0																																														
<i>sr</i> (S/R)	Run/Stop switching		5162																																														
<i>CAS</i> (CAS)	Switch to Cascade mode (when in cascade control)	0																																															
<i>AUT</i> (AUT)	Switch to Auto mode (when in cascade control)	0																																															
<i>MAN</i> (MAN)	Switch to Manual mode (when in cascade control)	0																																															
<i>SP0</i> (SP.0)	Bit-0 of SP number setting		5163																																														
<i>SP1</i> (SP.1)	Bit-1 of SP number setting		5164																																														
<i>SP2</i> (SP.2)	Bit-2 of SP number setting		5165																																														
<i>SP3</i> (SP.3)	Bit-3 of SP number setting		5166																																														

● UT Mode Parameters

Located in: Main menu = *Utnd* (UTMD) ; Submenu = *nd* (MD)

Parameter Symbol	Name of Parameter	Setting Range and Description	Initial Value	User Setting
<i>Utm</i> (UTM)	Controller mode (UT mode)	5: Loop Control for Backup For another controller mode, see the User's Manual (Reference) (CD-ROM version).	1	
<i>Snp</i> (SMP)	PV sampling period setting	50, 100, 200 and 500 ms The controller restarts if any change is made to the PV sampling period; this does not affect other parameter settings at all, however.	200 ms	
<i>Snc</i> (SMC)	Sampling period error counter (reading only)	0 to 30000	Shows 0 at power-on.	

● Input-related Parameters

Located in: Main menu = *Utnd* (UTMD) ; Submenu = *ln* (IN)

Parameter Symbol	Name of Parameter	Setting Range and Description	Initial Value	User Setting
<i>ln1</i> (IN1)	PV input type (INPUT 1 terminals) Terminals ①, ② and ③	Specify the type of PV input as a range code. OFF (0), 1 to 18, 30, 31, 35 to 37, 40, 41, 50, 51, 55, 56 See "Instrument Input Range Codes" in "2. Initial Settings".	OFF (0)	
<i>Un1</i> (UN1)	PV input unit	Select the unit of PV input. % (0): Percent °F (5): Fahrenheit °C (1): Degree Celsius - (2): No unit	Depends on the PV input type.	
<i>rH1</i> (RH1)	Max. value of PV input range	Set the instrument input range (RL1 < RH1). - For temperature input -	Depends on the PV input type.	
<i>rL1</i> (RL1)	Min. value of PV input range	Set the range of temperature that is actually controlled. - For voltage input - Set the range of a voltage signal that is applied. The scale across which the voltage signal is actually controlled should be set using the parameters Maximum Value of PV Input Scale (SH1) and Minimum Value of PV Input Scale (SL1).		
<i>dP1</i> (DP1)	PV input decimal point position (shown when in voltage-input mode)	Set the position of the decimal point of voltage-mode PV input. 0 to 4	Depends on the PV input type.	
<i>SH1</i> (SH1)	Max. value of PV input scale (shown when in voltage-input mode)	Set the read-out scale of voltage-mode PV input. -19999 to 30000, where SL1 < SH1	Depends on the PV input type.	
<i>SL1</i> (SL1)	Min. value of PV input scale (shown when in voltage-input mode)			
<i>bo1</i> (BO1)	Selection of PV input burnout action	Allows the PV input value to be determined as shown below in case of PV input burnout. • 105% of PV input range if set to "Upscale" • -5.0% of PV input range if set to "Downscale" OFF (0): Disable UP (1): Upscale DOWN (2): Downscale	Depends on the PV input type.	
<i>rJc</i> (RJC)	Presence/absence of PV input reference junction compensation	Allows input compensation to be applied to thermocouple input. OFF (0): Absent ON (1): Present	ON (1)	
<i>ln3</i> (IN3)	Tracking input type (INPUT 3 terminals) Terminals ② and ③	Specify the type of tracking input as a range code. 40, 41, 50, 51 See "Instrument Input Range Codes" in "2. Initial Settings".	41	
<i>Un3</i> (UN3)	Tracking input unit	Select the unit of tracking input. % (0): Percent °F (5): Fahrenheit °C (1): Degree Celsius - (2): No unit	% (0)	
<i>rH3</i> (RH3)	Maximum value of tracking input range	Set the range of a voltage signal. (RL3 < RH3)	5.000	
<i>rL3</i> (RL3)	Minimum value of tracking input range		1.000	
<i>dP3</i> (DP3)	Tracking input decimal point position	Not used in Loop Control for Backup.		
<i>SH3</i> (SH3)	Max. value of tracking input scale	Not used in Loop Control for Backup.		
<i>SL3</i> (SL3)	Min. value of tracking input scale			

Parameter Symbol	Name of Parameter	Setting Range and Description	Initial Value	User Setting
BO3 (BO3)	Tracking input burnout action selection	Allows the tracking input value to be determined as shown below in case of tracking input burnout. <ul style="list-style-type: none"> • 105% of tracking input scale if set to "Upscale" • -5.0% of tracking input scale if set to "Downscale" OFF (0): Disable UP (1): Upscale DOWN (2): Downscale	OFF (0)	
P.U1 (P.U1)	PV unit	Set the unit of PV. % (0): Percent °F (5): Fahrenheit °C (1): Degree Celsius - (2): No unit	Same as the unit of PV input	
P.D1 (P.D1)	PV decimal point position	Under normal operation, set the same value as in the PV Input Decimal Point Position (DP1) parameter. To shift the decimal point for temperature input, use this parameter. For example, set as "P.D1 = 0" to change a temperature reading of one decimal place to that of no decimal places. This involves reconfiguring the PH1 and PL1 parameters. 0 to 4	-	
P.H1 (P.H1)	Maximum value of PV range	Under normal operation, keep the values of these parameters between the maximum and minimum values of the PV input range. -19999 to 30000	Maximum value of PV input range or scale	
P.L1 (P.L1)	Minimum value of PV range	P.L1 < P.H1, where P.H1-P.L1 ≤ 30000	Minimum value of PV input range or scale	

● Output-related Parameters

Located in: Main menu = *Utnd* (UTMD) ; Submenu = *out* (OUT)

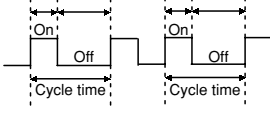
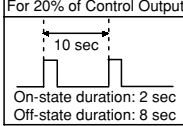
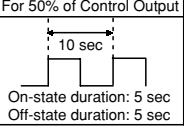
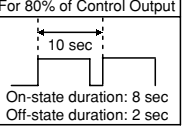
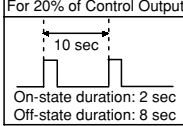
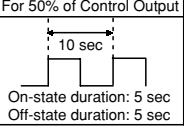
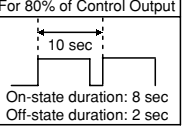
Parameter Symbol	Name of Parameter	Setting Range and Description	Initial Value	User Setting		
ot 1 (OT1)	Control output type	0 Time proportional PID relay contact output (terminals ① - ② - ③)	0 Heating/ cooling type : 4			
		1 Time proportional PID voltage pulse output (terminals ⑯ - ⑰)				
		2 Current output (terminals ⑯ - ⑰)				
		3 ON/OFF control relay contact output (terminals ① - ② - ③)				
		The following 4 to 12 are displayed only for heating/ cooling type controllers.				
		4 Heating-side relay output (terminals ① - ② - ③), cooling-side relay output (terminals ④⑤ - ④⑥ - ⑤⑦)				
		5 Heating-side pulse output (terminals ⑯ - ⑰), cooling-side relay output (terminals ④⑤ - ④⑥ - ⑤⑦)				
		6 Heating-side current output (terminals ⑯ - ⑰), cooling-side relay output (terminals ④⑤ - ④⑥ - ⑤⑦)				
		7 Heating-side relay output (terminals ① - ② - ③), cooling-side pulse output (terminals ④⑤ - ④⑥)				
		8 Heating-side pulse output (terminals ⑯ - ⑰), cooling-side pulse output (terminals ④⑤ - ④⑥)				
		9 Heating-side current output (terminals ⑯ - ⑰), cooling-side pulse output (terminals ④⑤ - ④⑥)				
		10 Heating-side relay output (terminals ① - ② - ③), cooling-side current output (terminals ④⑤ - ④⑥)				
		11 Heating-side pulse output (terminals ⑯ - ⑰), cooling-side current output (terminals ④⑤ - ④⑥)				
12 Heating-side current output (terminals ⑯ - ⑰), cooling-side current output (terminals ④⑤ - ④⑥)						
ct (CT)	Control output cycle time Heating-side control output cycle time in heating/cooling control	1 to 1000 sec.	30 sec.			
		 <p>Relay's Behavior when Cycle Time = 10 sec</p> <table border="1"> <thead> <tr> <th>For 20% of Control Output</th> <th>For 50% of Control Output</th> <th>For 80% of Control Output</th> </tr> </thead> <tbody> <tr> <td>  <p>On-state duration: 2 sec Off-state duration: 8 sec</p> </td> <td>  <p>On-state duration: 5 sec Off-state duration: 5 sec</p> </td> <td>  <p>On-state duration: 8 sec Off-state duration: 2 sec</p> </td> </tr> </tbody> </table>			For 20% of Control Output	For 50% of Control Output
For 20% of Control Output	For 50% of Control Output	For 80% of Control Output				
 <p>On-state duration: 2 sec Off-state duration: 8 sec</p>	 <p>On-state duration: 5 sec Off-state duration: 5 sec</p>	 <p>On-state duration: 8 sec Off-state duration: 2 sec</p>				
ctc (CTc)	Cooling-side control output cycle time	1 to 1000 sec.	30 sec.			
Ro 1 (AO1)	Analog output-1 type (OUTPUT 1: Terminals ⑯ and ⑰)	Allows control output or retransmission output to be presented as one of the following current signals. 0: 4 to 20 mA 1: 0 to 20 mA 2: 20 to 4 mA 3: 20 to 0 mA	0			
Ro 2 (AO2)	Analog output-2 type (OUTPUT 2: Terminals ④⑤ and ④⑥)		0			
Ro 3 (AO3)	Analog output-3 type (OUTPUT 3: Terminals ④ and ⑤)		0			
A1H (A1H)	Analog output-1 100% segmental point	Set the values of segmental points for the 0% and 100% output levels at which the values are presented via OUTPUT-1 (terminals ⑯ and ⑰). See "■ Performing Split Computations" below. -5.0% to 105.0%	100.0 %			
A1L (A1L)	Analog output-1 0% segmental point		0.0 %			
A2H (A2H)	Analog output-2 100% segmental point	Set the values of segmental points for the 0% and 100% output levels at which the values are presented via OUTPUT-2 (terminals ④⑤ and ④⑥). See "■ Performing Split Computations" below. -5.0% to 105.0%	100.0 %			
A2L (A2L)	Analog output-2 0% segmental point		0.0 %			

Parameter Symbol	Name of Parameter	Setting Range and Description	Initial Value	User Setting
A3H (A3H)	Analog output-3 100% segmental point	Set the values of segmental points for the 0% and 100% output levels at which the values are presented via OUTPUT-3 (terminals ⑭ and ⑮). See "■ Performing Split Computations" below. -5.0% to 105.0%	100.0 %	
A3L (A3L)	Analog output-3 0% segmental point		0.0 %	

■ Performing Split Computations

● V-mode Output

The following explains an example of letting "Analog OUTPUT-1 (terminals ⑯ and ⑰)" and "Analog OUTPUT-3 (terminals ⑭ and ⑮)" present the V-mode characteristics of split computations.

1. Set the Control Output Type (OT1) parameter to "2".
This sets the control output to "current output."
2. Set the Retransmission Output 1 (RT1) parameter to "3".
This sets the retransmission output to "control output retransmission."
3. Set the Analog Output-1 100% Segmental Point (A1H) parameter to "100%".
4. Set the Analog Output-1 0% Segmental Point (A1L) parameter to "25%".
5. Set the Analog Output-3 100% Segmental Point (A3H) parameter to "0%".
6. Set the Analog Output-3 0% Segmental Point (A3L) parameter to "75%".

The figure below shows an example where both analog outputs-1 and 3 are set to the current signal of 4 to 20 mA DC. The type of output signal can be determined separately for each of the analog outputs listed above, using the following three parameters.

Analog output-1: Analog output-1 type (AO1)

Analog output-2: Analog output-2 type (AO2)

Analog output-3: Analog output-3 type (AO3)

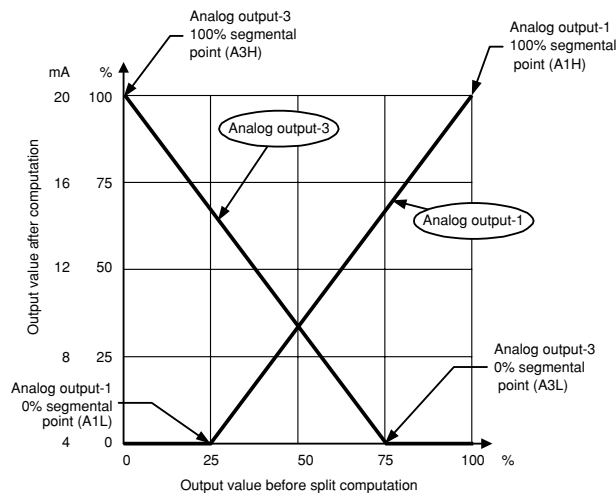

● Parallel-mode Output

The following explains an example of letting “Analog OUTPUT-1 (terminals ⑩ and ⑪)” and “Analog OUTPUT-3 (terminals ⑭ and ⑮)” present the parallel-mode characteristics of split computations.

1. Set the Control Output Type (OT1) parameter to “2”.
This sets the control output to “current output.”
2. Set the Retransmission Output 1 (RT1) parameter to “3”.
This sets the retransmission output to “control output retransmission.”
3. Set the Analog Output-1 100% Segmental Point (A1H) parameter to “100%”.
4. Set the Analog Output-1 0% Segmental Point (A1L) parameter to “25%”.
5. Set the Analog Output-3 100% Segmental Point (A3H) parameter to “75%”.
6. Set the Analog Output-3 0% Segmental Point (A3L) parameter to “0%”.

The figure below shows an example where both analog outputs-1 and 3 are set to the current signal of 20 to 0 mA DC. The type of output signal can be determined separately for each of the analog outputs listed above, using the following three parameters.

Analog output-1: Analog output-1 type (AO1)

Analog output-2: Analog output-2 type (AO2)

Analog output-3: Analog output-3 type (AO3)

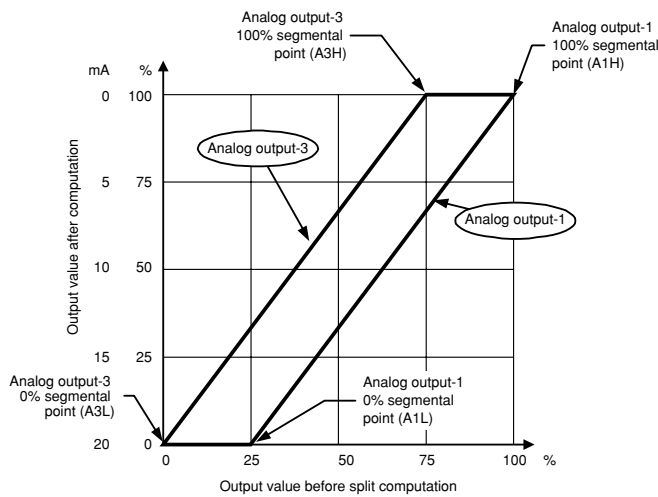

● Communication Parameters

Located in: Main menu = *Utnd* (UTMD) ; Submenu = *r485* (R485)

Parameter Symbol	Name of Parameter	Setting Range and Description	Initial Value	User Setting
<i>PSL</i> (PSL)	Protocol selection	0: PC link communication 1: PC link communication (with sum check) 2: Ladder communication 3: Coordinated master station 4: Coordinated slave station 7: MODBUS (ASCII) 8: MODBUS (RTU) 10: Coordinated slave station (loop-1 mode) 11: Coordinated slave station (loop-2 mode)	0	
<i>bPS</i> (BPS)	Baud rate	600 (0), 1200 (1), 2400 (2), 4800 (3), 9600 (4) (bps)	9600 (4)	
<i>Pri</i> (PRI)	Parity	NONE (0): None EVEN (1): Even ODD (2): Odd	EVEN (1)	
<i>STP</i> (STP)	Stop bit	1, 2	1	
<i>dLn</i> (DLN)	Data length	7, 8; 7 is fixed for MODBUS (ASCII) 8 is fixed for MODBUS (RTU), Ladder	8	
<i>Adr</i> (ADR)	Address	1 to 99 However, the maximum number of stations connectable is 31.	1	
<i>rPt</i> (RP.T)	Minimum response time	0 to 10 (× 10 ms)	0	

● **Value Calibration Related Parameters (Displayed for Position Proportional Controllers)**

Located in: Main menu = *Utnd* (UTMD) ; Submenu = *VALV* (VALV)

Parameter Symbol	Name of Parameter	Setting Range and Description	Initial Value	User Setting
<i>VAE</i> (V.AT)	Automatic valve adjustment	Automatically adjusts the fully-closed and fully-opened positions of a valve. When this function is used, there is no need for adjustment using the parameters V.RS, V.L and V.H. OFF (0): - ON (1): Start automatic adjustment	OFF (0)	
<i>VrS</i> (V.RS)	Valve position setting reset	The parameters V.RS, V.L and V.H are designed for manual adjustment of valve positions. Setting V.RS to 1 resets the valve adjustment settings and causes the indication "V.RS" to blink.	0	
<i>VL</i> (V.L)	Fully-closed valve position setting	Pressing the SET/ENT key with valve position set to the fully-closed position causes the adjusted value to be stored. When V.L adjustment is complete, V.L. stops blinking.	Undefined	
<i>VH</i> (V.H)	Fully-opened valve position setting	Pressing the SET/ENT key with valve position set to the fully-opened position causes the adjusted value to be stored. When V.H adjustment is complete, V.H. stops blinking.	Undefined	
<i>Trt</i> (TR.T)	Valve traveling time	5 to 300 sec. Used to operate a valve according to the estimated valve position. Set the time required for the valve to open fully from a state of being fully closed. Confirm the valve traveling time by consulting the datasheet of the valve's specifications. The valve traveling time is only effective when Valve Adjustment Mode (V.MD) is set to 1 or 2.	60 sec.	
<i>Vnd</i> (V.MD)	Valve adjusting mode	0: Valve position feedback type 1: Valve position feedback type (moves to the estimating type if a valve input error or burnout occurs.) 2: Valve position estimating type	0	

● **Parameter-initializing Parameters**

Located in: Main menu = *Utnd* (UTMD) ; Submenu = *INIT* (INIT)

Parameter Symbol	Name of Parameter	Setting Range and Description	Initial Value	User Setting
<i>INI</i> (INI)	Parameter initialization	OFF (0): - ON (1): Initialize parameters	OFF (0)	

■ Tips About Heating/Cooling Control (for heating/cooling controllers only)

In heating/cooling control, the controller outputs the result of computation after splitting it into heating-purpose and cooling-purpose signals. In addition, the controller can perform PID control or ON/OFF control on the heating and cooling sides separately. When performing ON/OFF control, set the proportional band to “0”.

The controller splits the result of computation (0 to 100%) into heating-side and cooling-side signals, as described below.

- 0% to 50% of the computation result is presented as a 0% to 100% cooling-side output.
- 50% to 100% of the computation result is presented as a 0% to 100% heating-side output.

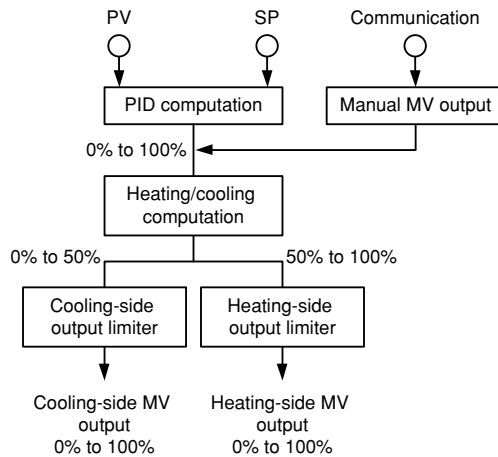

Heating/cooling control provides two methods in which either none of the heating- and cooling-side outputs are presented or both of the heating- and cooling-side outputs are presented, as shown in the following figures.

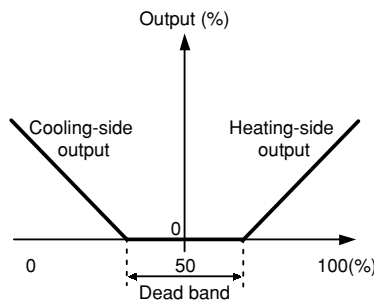

Value of control output before split into heating- and cooling-side outputs

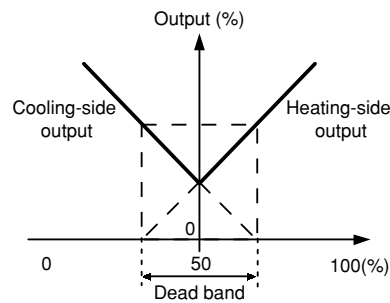

Value of control output before split into heating- and cooling-side outputs



Precautions in Heating/Cooling Control

- Keep the ratio of the heating-side proportional band (P) to the cooling-side proportional band (Pc) equal to or below 5.
- If neither the heating-side nor the cooling-side is performing ON/OFF control, setting the integral time (I or Ic) of one side to “0” results in the Integral Time parameters of both sides being set to “OFF”, irrespective of the integral time setting of the other side.

■ Tips About Position Proportional Control (for position proportional controllers only)

Position proportional control can be of either feedback type or estimating type. In feedback-type position proportional control, the controller obtains a valve position signal from a feedback slide-wire resistor attached to a valve.

In estimating-type position proportional control, you set the operating time required for a valve to change from the fully-closed position to the fully-open position beforehand. With the preset operating time, the controller controls the valve by estimating its position. In the case of estimating-type position proportional control, there is no need for feedback input wiring.

Feedback-type position proportional control is superior to the estimating type in terms of control performance. When in manual operation, you can directly manipulate the controller's output terminals. Pressing the  key sends the valve into opening motion while pressing the  key sends it into closing motion.

The figure below shows a schematic representation of a loop configured for position proportional control.

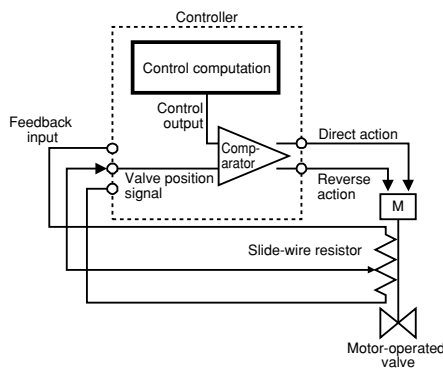

6. Function Block Diagram and Descriptions

This chapter contains the function block diagrams for “Loop control for backup”, “Heating/cooling loop control for backup”, and “Position-proportional loop control for back up.” For details on these function block diagrams, refer to the descriptions mentioned later.

In the function block diagram for “Loop control for backup”, some contact input/output that UT520 does not have appear. Refer to the function block diagram after confirming the presence/absence of the contact input/output.

Function Block Diagram for Loop Control for Backup

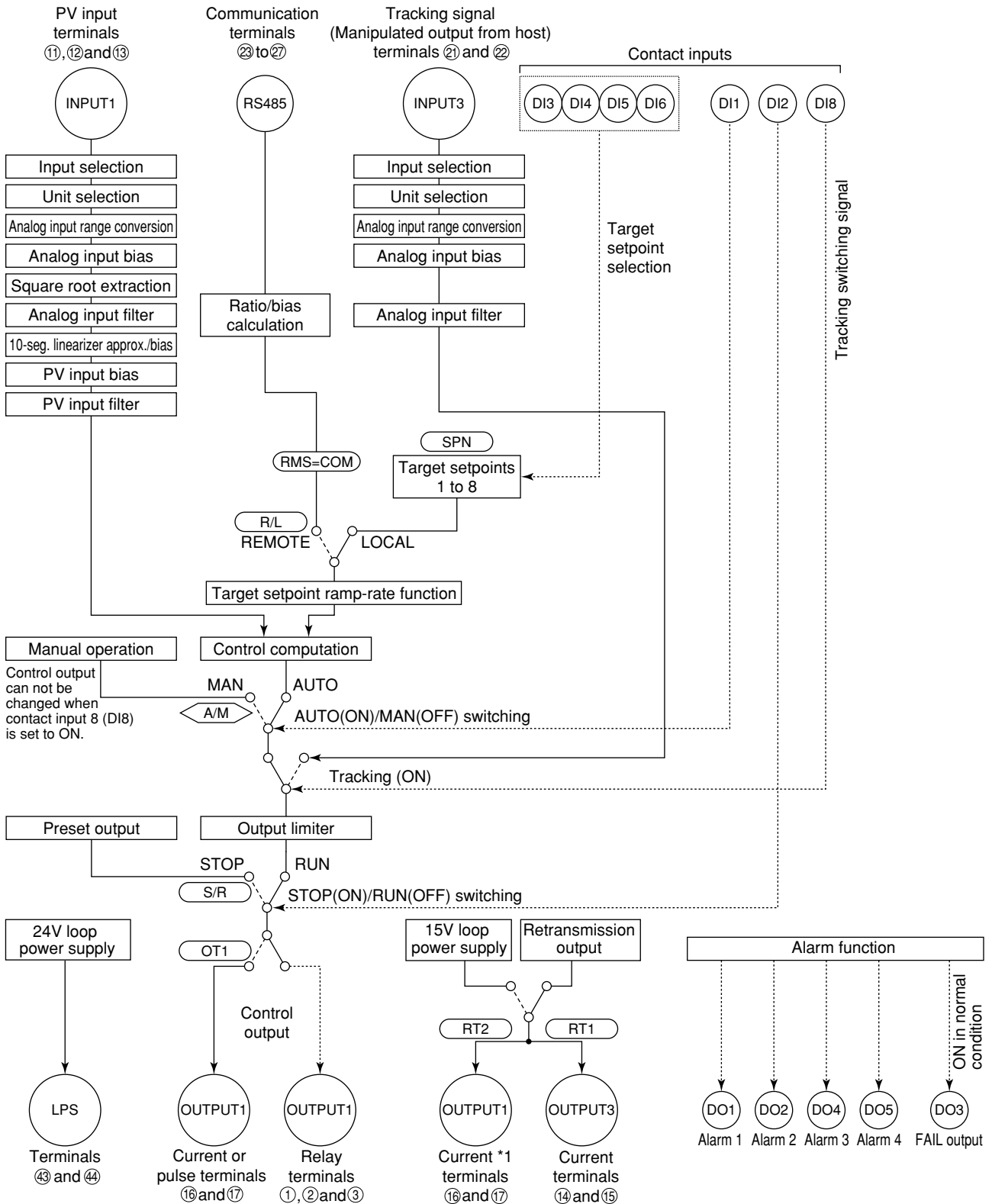

*1 Unavailable when control output is current or pulse.

Function Block Diagram for Heating/Cooling Loop Control for Backup

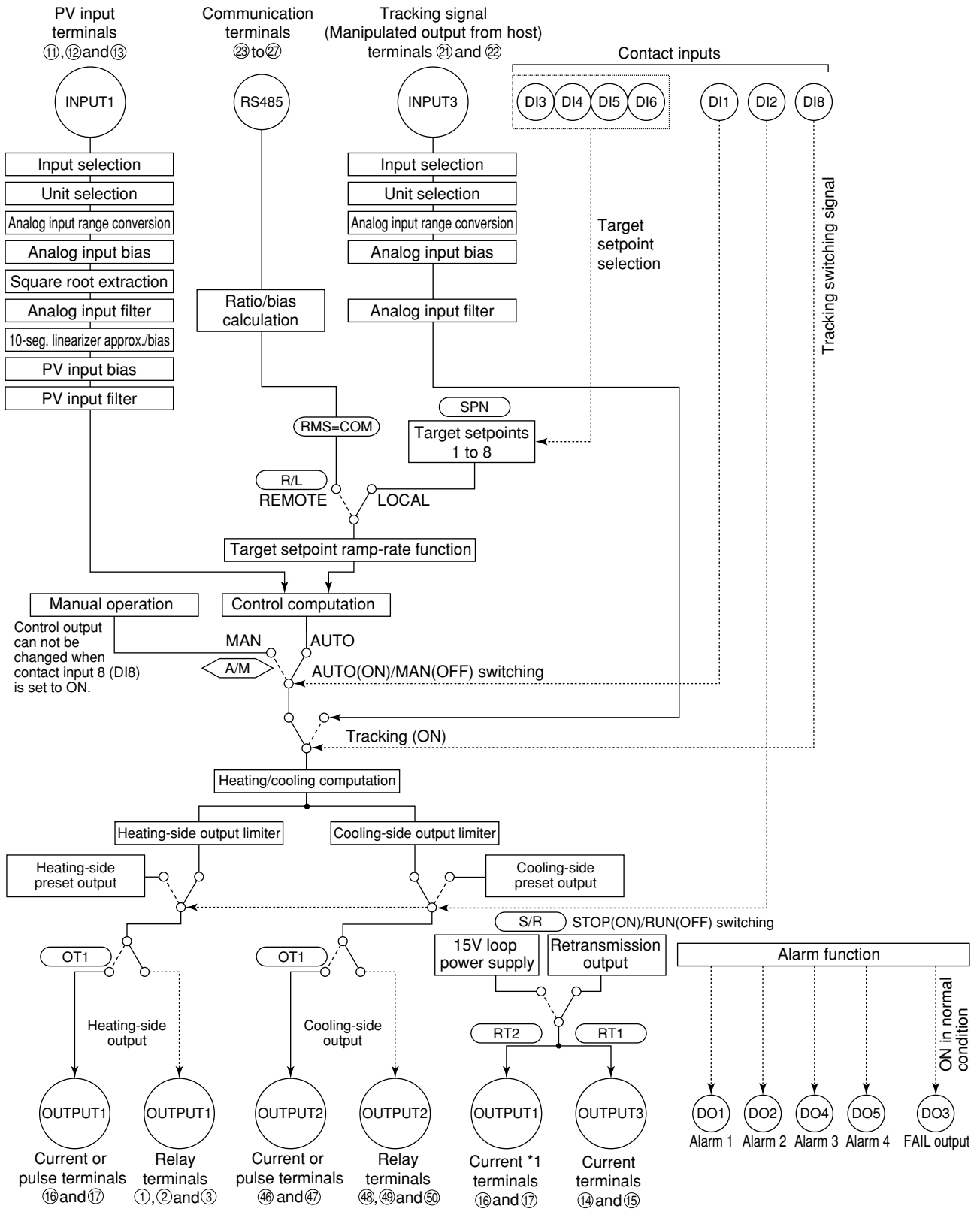

*1 Unavailable when control output is current or pulse.

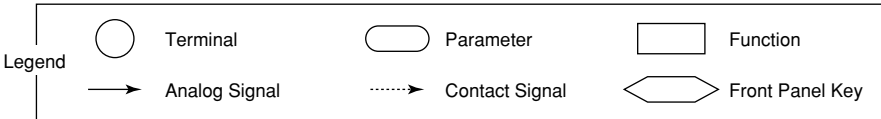

Function Block Diagram for Position Proportional Loop Control for Backup

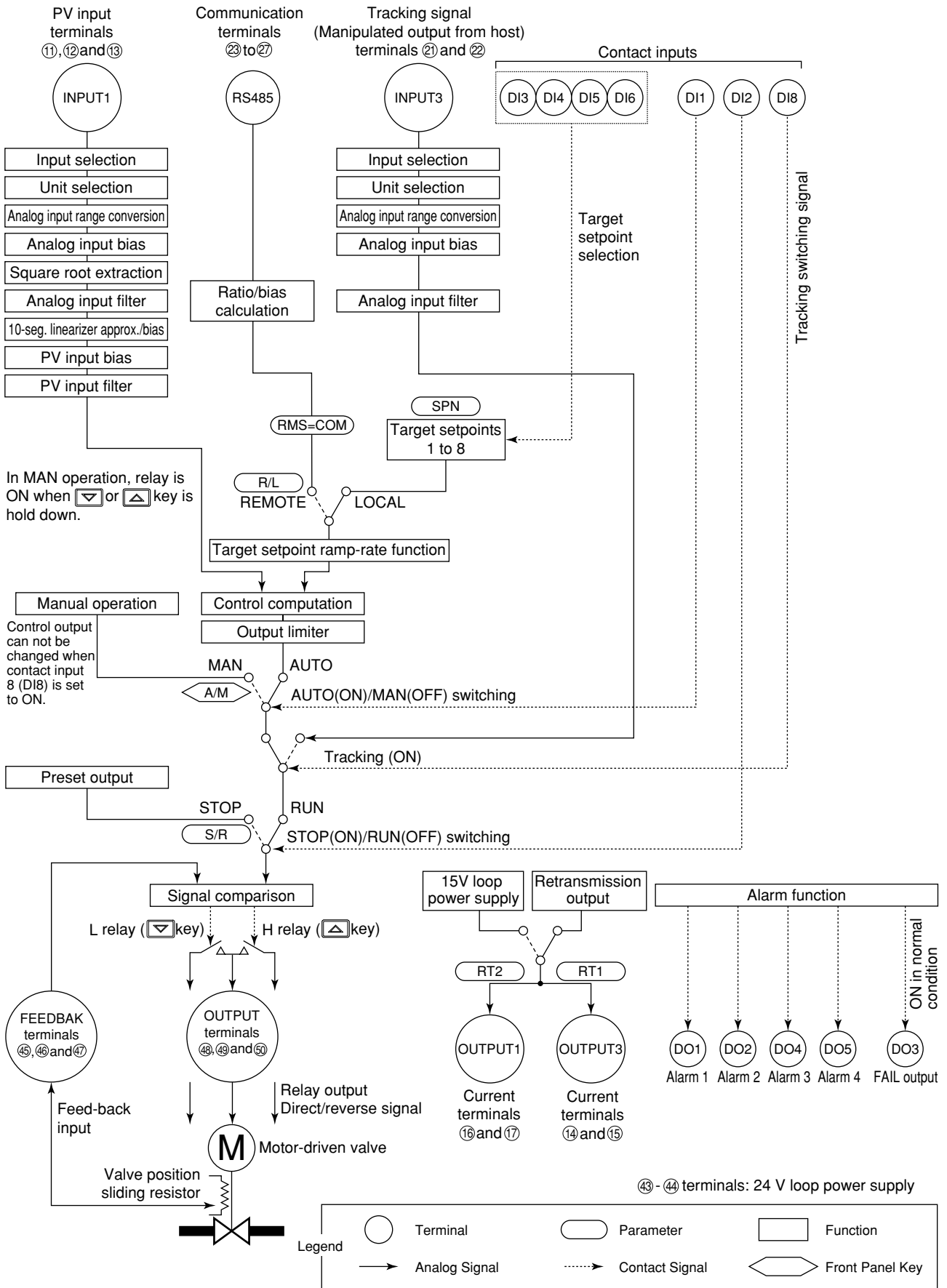

Functions and Parameters for “Loop Control for Backup” in Initial State

Functions and parameters in initial state are given in the tables below. For details on each parameter, refer to “5.2 Lists of Parameters.”

■ PV Input

PV input (INPUT1) is a universal input, which can receive signals from a thermocouple or RTD, or DC voltage signals. The controller is capable of biasing, square root extraction, first-order lag computation (filtering), ten-segment linearizer approximation, and ten-segment linearizer biasing on input signals.

Each function can be set by the following parameters.

Setup Parameters

Function	Parameter	Main menu	Submenu
Input selection	IN1	UTMD	IN
Unit selection	UN1	UTMD	IN
Analog input range conversion	RH1, RL1(DP1, SH1, SL1)	UTMD	IN
Analog input bias	BS1	CMLP	AIN
Square root extraction	SR1, LC1	CMLP	AIN
Analog input filter	FL1	CMLP	AIN

Operating Parameters

Function	Parameter	Main menu	Submenu
Ten-segment linearizer mode	1.MD	PYS1	None
Ten-segment linearizer approximation/biasing	1.A1 to 1.AB, 1.B1 to 1.BB	PYS1	None
PV input bias	BS	LP1	PAR
PV input filter	FL	LP1	PAR

Note: PV input bias (BS) and PV input filter (FL) among the operating parameters are used as bias and filter when normal operation. Analog input bias (BS1) and analog input filter (FL1) among the setup parameters are used when PV correction value is decided in advance.

■ Tracking Input

Tracking input (INPUT3) can receive the DC voltage signals. The controller is capable of biasing, first-order lag computation (filtering) on tracking input signals.

When DI8 (contact input 8) is ON, the tracking input is the output of the controller. When DI8 (contact input 8) is OFF, the result of PID computation of the controller is output. Each function can be set by the following parameters.

Setup Parameters

Function	Parameter	Main menu	Submenu
Input selection	N3	UTMD	IN
Unit selection	UN3	UTMD	IN
Analog input range conversion	RH3, RL3	UTMD	IN
Analog input bias	BS3	CMLP	AIN
Analog input filter	FL3	CMLP	AIN

■ Remote Input



Remote input signal can be received via communication. The controller is capable of ratio biasing on remote input signals.

Each function can be set by the following parameters.

Operating Parameters

Function	Parameter	Main menu	Submenu
Ratio bias calculation	RT, RBS	LP1	PAR
Remote/Local switching	MOD(REM/LCL)	MODE	None

■ Contact Input

Automatic (ON) / Manual (OFF) mode switching function is assigned to DI1 (contact input 1). Manipulated output can be changed using the  and  keys in manual mode. Run (OFF) / Stop (ON) switching function is assigned to DI2 (contact input 2). Preset output value is output when the operation is stopped. PV input and alarms remain functioning as normal.

It is possible to select one out of eight setpoints by turning the four contact input signals ON or OFF. This function is assigned to DI3 (contact input3) to DI6 (contact input6).

Contact input	Selected target setpoint number (SPN)								If all contact inputs are set to "OFF", the controller uses the immediately preceding target setpoint.
	1	2	3	4	5	6	7	8	
DI3	ON	OFF	ON	OFF	ON	OFF	ON	OFF	
DI4	OFF	ON	ON	OFF	OFF	ON	ON	OFF	
DI5	OFF	OFF	OFF	ON	ON	ON	ON	OFF	
DI6	OFF	OFF	OFF	OFF	OFF	OFF	OFF	ON	

For example, set contact input 4 (DI4) only to "ON" to change target setpoint 1 to 2. Set contact inputs 3 (DI3) and 4 (DI4) to "ON" to select target setpoint 3.

No function is assigned to DI7 (contact input 7).
Tracking switching function is assigned to DI8 (contact input 8).

Status of DI8	Output tracking operation
ON	Tracking input signal is output as manipulated output signal of the controller.
OFF	Result of PID computation of the controller is output.

■ Target Setpoint and PID

It is possible to use a maximum of eight groups of target setpoints and PID parameters. The target setpoint can be selected by key operation or contact input. For selection by contact input, refer to "Contact Input."

Operating Parameters

Function	Parameter	Main menu	Submenu
Target setpoint number selection	SPN	MODE	None
Target setpoint 1 to 8	n.SP	LP1	n.PID
Proportional band (P)	n.P	LP1	n.PID
Integral time (I)	n.I	LP1	n.PID
Derivative time (D)	n.D	LP1	n.PID
Cooling-side proportional band (Pc)	n.Pc	LP1	n.PID
Cooling-side integral time (Ic)	n.Ic	LP1	n.PID
Cooling-side derivative time (Dc)	n.Dc	LP1	n.PID

Note: Parameters n.SP, n.P, n.I, n.D, n.Pc, n.Ic, n.Dc (n=1 to 8), and submenu n.PID (n= 1 to 8) correspond to the target setpoint number selected in the target setpoint number selection (SPN).

The target setpoint ramp rate setting function prevents the target setpoint from changing suddenly. It is possible to set the upward and downward changing rate (i.e., ramp rate) independently in the parameters UPR and DNR. The unit of the ramp rate (hour, or minute) is specified in TMU.

Setup Parameters

Function	Parameter	Main menu	Submenu
Ramp-rate time unit setting	TMU	LOOP1	SP

Operating Parameters

Function	Parameter	Main menu	Submenu
Target setpoint ramp-rate setting	UPR, DNR	LP1	PAR

■ Control Output

Control output (OUTPUT1) selects the output type among the current output, voltage pulse output, and relay contact output signal. For heating/cooling control, the cooling-side signals are output to OUTPUT2.

Preset output value is output when the operation is stopped by key operation or contact input, which takes priority over the manual operation.

Each function can be set by the following parameters.

Setup Parameters

Function	Parameter	Main menu	Submenu
Control output type	OT1	UTMD	OUT
Control output cycle time	CT	UTMD	OUT
Cooling-side control output cycle time	CTc	UTMD	OUT
Analog output 1 type	AO1	UTMD	OUT
Analog output 2 type (cooling-side)	AO2	UTMD	OUT

Operating Parameters

Function	Parameter	Main menu	Submenu
Preset output	n.PO	LP1	n.PID
Cooling-side preset output	n.Oc	LP1	n.PID
Output limiter	n.OL, n.OH	LP1	n.PID

Note: Parameters n.PO, n.Oc, n.OL, n.OH (n=1 to 8), and submenu n.PID (n= 1 to 8) correspond to the target setpoint number selected in the target setpoint number selection (SPN).

■ Contact Output

Alarm 1 is output via DO1 (contact output 1).

Alarm 2 is output via DO2 (contact output 2).

FAIL is output via DO3 (contact output 3). ON in the normal condition and OFF in the FAIL condition.

Alarm 4 is output via DO4 (contact output 4).

Alarm 3 is output via DO5 (contact output 5)

No function is assigned to DO6 (contact output 6) and DO7 (contact output 7).

Setup Parameters

Function	Parameter	Main menu	Submenu
Alarm 1 type	AL1	LOOP1	ALM
Alarm 2 type	AL2	LOOP1	ALM
Alarm 3 type	AL3	LOOP1	ALM
Alarm 4 type	AL4	LOOP1	ALM

Operating Parameters

Function	Parameter	Main menu	Submenu
Alarm 1 setpoint	n.A1	LP1	n.PID
Alarm 2 setpoint	n.A2	LP1	n.PID
Alarm 3 setpoint	n.A3	LP1	n.PID
Alarm 4 setpoint	n.A4	LP1	n.PID

Note: Submenu n.PID (n= 1 to 8) corresponds to the target setpoint number selected in the target setpoint number selection (SPN).

■ Retransmission Output

PV, target setpoint, or control output can be output to retransmission output 1 (OUTPUT3). Each function can be set by the following parameters.

Setup Parameters

Function	Parameter	Main menu	Submenu
Retransmission output 1 type	RT1	CMLP	RET
Retransmission output 1 scale	TH1, TL1	CMLP	RET
Retransmission output 2 type	RT2	CMLP	RET
Retransmission output 2 scale	TH2, TL2	CMLP	RET

■ 15VDC Loop Power Supply

The 15V DC loop power supply (OUTPUT3) uses the same terminal as retransmission output 1 or 2. The 15V DC loop power supply can not be used when retransmission output 1 or 2 is used. To use the 15V DC loop power supply, set "4" in retransmission output 1 type (RT1) or retransmission output 2 type (RT2). Each function can be set by the following parameters.

Setup Parameters

Function	Parameter	Main menu	Submenu
Retransmission output 1 type	RT1	CMLP	RET
Retransmission output 2 type	RT2	CMLP	RET

Blank Page

Revision Information

- Title : Models UT550/UT520 Digital Indicating Controllers User's Manual for Loop Control for Backup
- Manual No. : IM 05D01C02-45E

Mar. 2000/1st Edition

Newly published

Written by Products Documents
Controllers & Conditioners Division
Yokogawa M&C Corporation
Published by Yokogawa M&C Corporation
1-19-18 Nakacho, Musashino-shi, Tokyo 180-0006, JAPAN
