

Pyxis®

ST-730 Series Inline Turbidity Sensor User Manual



Water Professionals Deserve Better Tools.

www.pyxis-lab.com

ST-730 Series Inline Turbidity Sensors User Manual

January 17, 2022
Rev. 1.37

Pyxis Lab, Inc.
1729 Majestic Dr. Suite 5
Lafayette, CO 80026 USA
www.pyxis-lab.com

Table of Contents

1	Introduction	2
2	Specifications	2
3	Unpacking Instrument	3
3.1	Standard Accessories	3
3.2	Optional Accessories	4
4	Installation	5
4.1	ST-730/730B/731/735 Piping	5
4.2	ST-730SS Piping	6
4.3	Wiring	7
4.4	Connecting via Bluetooth	7
4.5	Connecting via USB	8
5	Setup and Calibration with uPyxis® Mobile App	8
5.1	Download uPyxis® Mobile App	8
5.2	Connecting to uPyxis® Mobile App	9
5.3	Calibration Screen and Reading	10
5.4	Diagnosis Screen	10
5.5	Device Info Screen	11
6	Setup and Calibration with uPyxis® Desktop App	12
6.1	Install uPyxis® Desktop App	12
6.2	Connecting to uPyxis® Desktop App	12
6.3	Information Screen	13
6.4	Calibration Screen	13
6.5	Diagnosis Screen	14
7	Outputs	14
7.1	4–20mA Output Setup	14
7.2	Adjusting 4–20mA Span	15
7.3	Communication using Modbus RTU	15
8	Sensor Maintenance and Precaution	16
8.1	Methods to Cleaning the ST-730 Series Sensor	16
8.2	Storage	17
9	Troubleshooting	17
10	Contact Us	17

Warranty Information

Confidentiality

The information contained in this manual may be confidential and proprietary and is the property of Pyxis Lab, Inc. Information disclosed herein shall not be used to manufacture, construct, or otherwise reproduce the goods described. Information disclosed herein shall not be disclosed to others or made public in any manner without the express written consent of Pyxis Lab, Inc.

Standard Limited Warranty

Pyxis Lab warrants its products for defects in materials and workmanship. Pyxis Lab will, at its option, repair or replace instrument components that prove to be defective with new or remanufactured components (i.e., equivalent to new). The warranty set forth is exclusive and no other warranty, whether written or oral, is expressed or implied.

Warranty Term

The Pyxis warranty term is thirteen (13) months ex-works. In no event shall the standard limited warranty coverage extend beyond thirteen (13) months from original shipment date.

Warranty Service

Damaged or dysfunctional instruments may be returned to Pyxis for repair or replacement. In some instances, replacement instruments may be available for short duration loan or lease.

Pyxis warrants that any labor services provided shall conform to the reasonable standards of technical competency and performance effective at the time of delivery. All service interventions are to be reviewed and authorized as correct and complete at the completion of the service by a customer representative, or designate. Pyxis warrants these services for 30 days after the authorization and will correct any qualifying deficiency in labor provided that the labor service deficiency is exactly related to the originating event. No other remedy, other than the provision of labor services, may be applicable.

Repair components (parts and materials), but not consumables, provided during a repair, or purchased individually, are warranted for 90 days ex-works for materials and workmanship. In no event will the incorporation of a warranted repair component into an instrument extend the whole instrument's warranty beyond its original term.

Warranty Shipping

A Repair Authorization (RA) Number must be obtained from Pyxis Technical Support before any product can be returned to the factory. Pyxis will pay freight charges to ship replacement or repaired products to the customer. The customer shall pay freight charges for returning products to Pyxis. Any product returned to the factory without an RA number will be returned to the customer. To receive an RMA you can generate a request on our website at <https://pyxis-lab.com/request-tech-support/>.

Pyxis Technical Support

Contact Pyxis Technical Support at +1 (866) 203-8397, service@pyxis-lab.com, or by filling out a request for support at <https://pyxis-lab.com/request-tech-support/>.

1 Introduction

The Pyxis ST-730 Series sensor is a pre-scaled inline sensor that measures turbidity in water using a white LED as the excitation light source and by measuring the scattered light at a 90-degree angle with respect to the excitation beam. The fluidic and optical arrangement of the ST-730 Series sensor is designed to overcome many shortcomings associated with other inline turbidimeters. It can be easily inserted into the custom-made tee with a compression fitting port designed to ensure correct vertical positioning of the ST-730 Series sensor in the fluid stream. The ST-730 Series sensor custom mounting tee has two ¾ inch female NPT ports for plumbing into an existing ¾ inch sample water line. The ST-730 Series sensor can be connected to any device that accepts an isolated or non-isolated 4–20mA input or RS-485 Modbus input. The ST-730 Series sensor has a short fluidic channel that can be easily cleaned and calibrated using the MA-WB Bluetooth adapter and uPyxis® Mobile or Desktop App.

2 Specifications

Table 1. ST-730, ST-730B, ST-731, and ST-735 Specifications

Specifications*	ST-730	ST-730B	ST-731	ST-735
Part Number (P/N)	53201	53202	53505	53204
Turbidity Range	0–100 NTU	0–1,000 NTU	0–10 NTU	0–10,000 NTU
Turbidity Resolution	0.1 NTU	1 NTU	0.05 NTU	10 NTU
Turbidity Accuracy	±2% of reading			
Method	Nephelometric, with white LED and IR LED (860 nm) light sources			
Calibration	Two-point calibration against standard solution			
Outputs	4–20mA Analog Output, RS-485 Digital Output with Modbus protocol			
Installation	Custom tee assembly (P/N: ST-001) with 3/4" FNPT socket & threaded ports			
Cable Length	5 ft, with IP67 connectors. 30 ft and 60 ft extension cables available			
Power Supply	22–26 VDC, 1 W			
Dimension (L × Dia)	6.8 × 1.44 inch (172.7 × 36.6 mm)			
Weight	0.37 lbs (170 g)			
Material	CPVC			
Operational Temperature	40–120 °F (4–49 °C)			
Storage Temperature	20–150 °F (-7–66 °C)			
Pressure	Up to 100 psi (0.7 MPa)			
Enclosure Rating	IP66			
Regulation	CE			

* With Pyxis's continuous improvement policy, these specifications are subject to change without notice.

Table 2. ST-730SS Specifications

Specifications*	ST-730SS
Part Number (P/N)	50626
Turbidity Range	0–100 NTU
Turbidity Resolution	0.1 NTU
Turbidity Accuracy	±2% of reading
Method	Nephelometric, with white LED and IR LED (860 nm) light sources
Calibration	Two-point calibration against standard solution
Outputs	4–20mA Analog Output, RS-485 Digital Output with Modbus protocol
Installation	3/4" FNPT threaded ports
Cable Length	5 ft, with IP67 connectors
Power Supply	22–26 VDC, 1 W
Dimension	See Figure 4
Weight	2.5 lbs (1130 g)
Material	304 Stainless Steel
Operational Temperature	40–120 °F (4–49 °C)
Storage Temperature	20–150 °F (-7–66 °C)
Pressure	Up to 290 psi (2.0 MPa) at 149 °F (65 °C)
Enclosure Rating	IP66
Regulation	CE

* With Pyxis's continuous improvement policy, these specifications are subject to change without notice.

3 Unpacking Instrument

Remove the instrument and accessories from the shipping container and inspect each item for any damage that may have occurred during shipping. Verify that all accessory items are included. If any item is missing or damaged, please contact Pyxis Lab Customer Service at service@pyxis-lab.com.

3.1 Standard Accessories

- Tee Assembly 3/4" NPT (1x Tee, O-ring, and Nut) P/N: ST-001
 NOTE ST-001 is not included for ST-730SS
- 7-Pin Female Adapter/Flying Leads Cable (2 ft) P/N: MA-1100
- User Manual available online at <https://pyxis-lab.com/support/>

3.2 Optional Accessories

The following optional accessories can be ordered from Pyxis Customer Service (order@pyxis-lab.com) or Pyxis E-Store at <https://pyxis-lab.com/shop/>.

 PYXIS INLINE SENSOR ACCESSORIES - SELECT*A*GUIDE 		
Accessory Name/Description	Part Number	Photo
Pyxis ST Series Cleaning Kit <i>(Includes 500mL Sensor Cleaner / Qtips & Pipe Cleaners)</i>	SER-01	
0.75" NPT Inline Sensor Tee Assembly <i>(All ST Series Sensors)</i>	50704	
2.0" NPT Inline Sensor Tee Assembly <i>(All ST Series Sensors)</i>	50756	
3.0" NPT Inline Sensor Tee Assembly <i>(All ST Series Sensors)</i>	50775	
ST-002 Inline Sensor Removal PLUG <i>(Allows ST Sensor Removal)</i>	ST-002	
ST Series Sensor Tee Replacement O-Ring <i>(All ST Series Tee's)</i>	MA-150	
ST Series Submersion Adapter Kit <i>(Submersible Kit for all ST-Series Sensors)</i>	MA-102S	
MA-WB Bluetooth Adapter for All ST Series Sensors <i>(4-20mA & RS-485)</i>	MA-WB	
MA-485 USB Adapter for All ST Series Sensors <i>(4-20mA RS-485)</i>	MA-485	
Bluetooth PC to Handheld Adapter <i>(For uPyxis Firmware Updates)</i>	MA-NEB	
PowerPack 1 <i>(Single Channel Power Supply w/Bluetooth)</i>	MA-BLE-1	
PowerPack 4 <i>(Four Channel Power Supply w/Bluetooth)</i>	MA-BLE-4	
MA-1100 <i>(24' Flying Lead Cable for All ST Sensors)</i>	MA-1100	
MA-C10 <i>(10' Extension Cable for All ST Sensors)</i>	50738	
MA-C50 <i>(50' Extension Cable for All ST Sensors)</i>	50705	

Figure 1.

Pyxis®		PYXIS TURBIDITY STANDARDS: SELECT-A-GUIDE					Pyxis®
Product Specification	NTU-10	NTU-50	NTU-100	NTU-200	NTU-500	NTU-1000	
P/N	57010-4	57009	57010	57010-1	57010-2	57010-3	
Turbidity (NTU)	10 ± 0.2	50 ± 1	100 ± 2	200 ± 4	500 ± 10	1000 ± 20	
% Accuracy						± 2%	
pH				8.0 ± 0.2			
Container (oz. / mL)				16 / 500			
Storage Condition (°F)				40-104			
Shelf Life (Months)				6			
Net Volume (mL)				510 ± 10			
Total Weight (g)				600 ± 10			

Figure 2.

4 Installation

4.1 ST-730/730B/731/735 Piping

The provided ST-001 Tee Assembly can be connected to a pipe system through the 3/4" female ports, either socket or NPT threaded. To properly install the ST-730/730B/731/735 sensor into the ST-001 Tee Assembly, follow the steps below:

1. Insert the provided O-ring into the O-ring groove on the tee.
2. Insert the ST-730/730B/731/735 sensor into the tee.
3. Tighten the tee nut onto the tee to form a water-tight, compression seal.

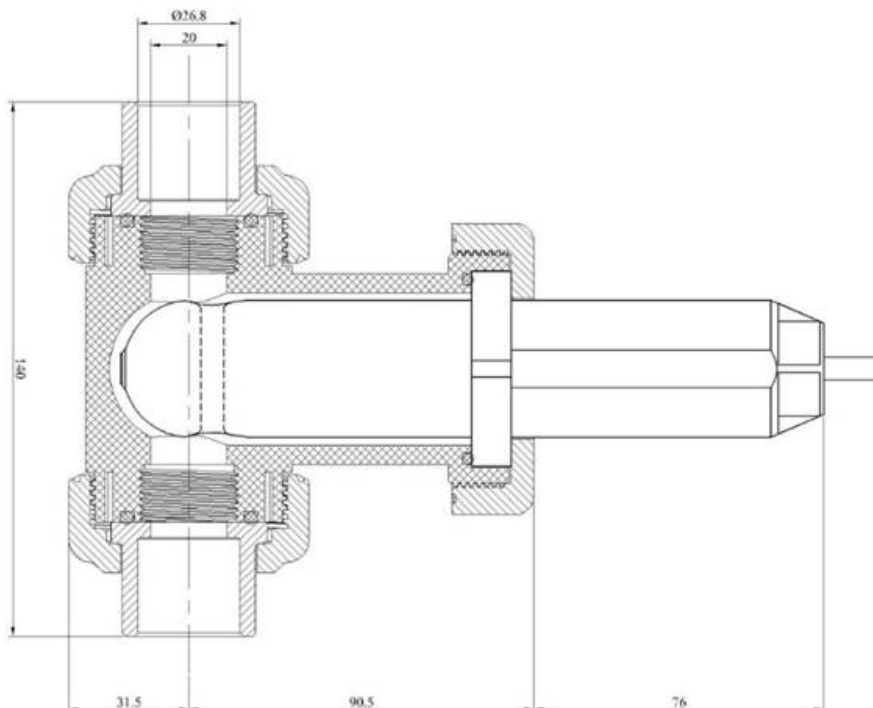

Figure 3. Dimension of the ST-730/730B/731/735 and the ST-001 Tee Assembly (mm)

NOTE It is recommended to install the ST-730 Series sensor tee in the pipe system where sample water flow is vertical.

4.2 ST-730SS Piping

The ST-730SS sensor has 3/4" female NPT threaded ports on the sensor itself and therefore does not require a custom tee assembly. It is recommended that two 3/4" NPT to 1/4" tubing adapters are used to connect the sensor to the sampling system. Sample water entering the sensor must be cooled down to below 120 °F (49 °C). The sensor can be held by a 1.75-inch pipe clamp or mounted to a panel with four 1/4-28 bolts. See Figure 4 for ST-730SS dimensions.

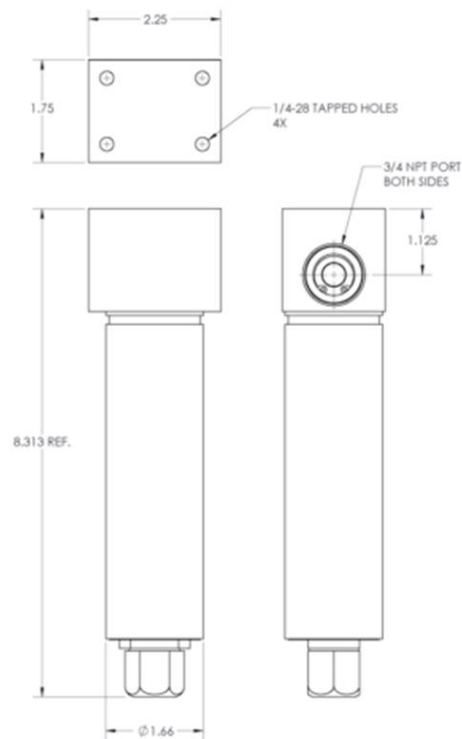

Figure 4. Dimension of the ST-730SS (inch)

4.3 Wiring

If the power ground terminal and the negative 4–20mA terminal in the controller are internally connected (non-isolated 4–20mA input), it is unnecessary to connect the 4–20mA negative wire (green) to the 4–20mA negative terminal in the controller. If a separate DC power supply other than that from the controller is used, make sure that the output from the power supply is rated for 22–26 VDC @ 65mA.

NOTE *The negative 24V power terminal (power ground) and the negative 4–20mA terminal on the ST-730 Series sensor are internally connected.*

Follow the wiring table below to connect the ST-730 Series sensor to a controller:

Table 3.

Wire Color	Designation
Red	24V +
Black	24V Power ground
White	4–20mA +
Green*	4–20mA -
Blue	RS-485 A
Yellow	RS-485 B
Clear	Shield, earth ground

* Internally connected to the power ground

4.4 Connecting via Bluetooth

A Bluetooth adapter (P/N: MA-WB) can be used to connect a ST-730 Series sensor to a smart phone with the **uPyxis®** Mobile App or a computer with a Bluetooth/USB Adapter (P/N: MA-NEB) and the **uPyxis®** Desktop App. The power should be sourced from a 24 VDC power terminal of a controller. If a controller is not available, please purchase a Pyxis PowerPack-1 (P/N: MA-BLE-1) or PowerPack-4 (P/N: MA-BLE-4) auxiliary power supply with Bluetooth, or an alternative 24 V power supply that can directly connect to the ST-730 Series sensor with proper cable connectors from Pyxis.

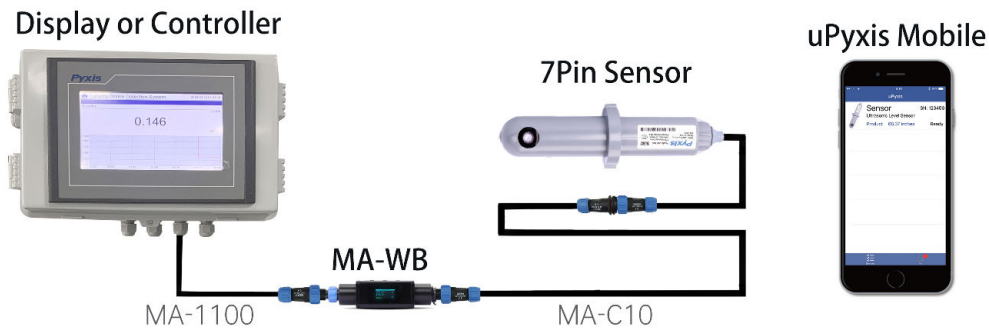

Figure 5. Bluetooth connection to ST-730 Series sensor with MA-WB and uPyxis Mobile App.

4.5 Connecting via USB

A USB-RS485 adapter (P/N: MA-485) can be used to connect a ST-730 Series sensor to a computer with the uPyxis® Desktop App.

NOTE Using non-Pyxis USB-RS485 adapters may result in permanent damage of the ST-730 Series sensor communication hardware.

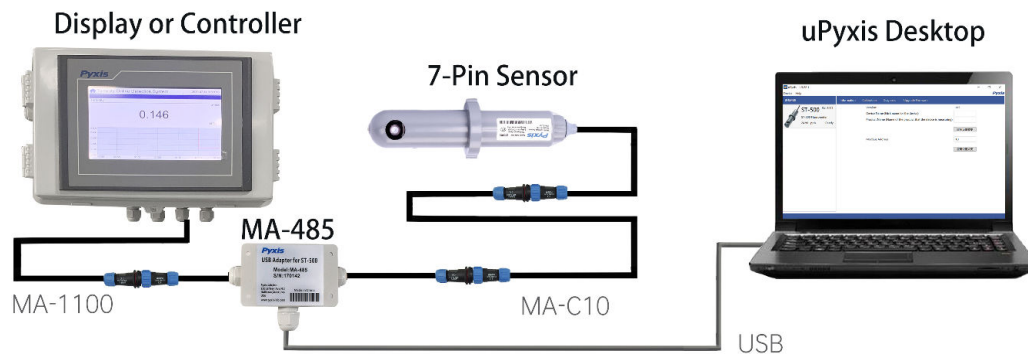

Figure 6. USB connection to ST-730 Series sensor with MA-485 and uPyxis Desktop App.

5 Setup and Calibration with uPyxis® Mobile App

5.1 Download uPyxis® Mobile App

Download uPyxis® Mobile App from [Apple App Store](#) or [Google Play](#).



Figure 7. uPyxis® Mobile App installation

5.2 Connecting to uPyxis® Mobile App

Connect the ST-730 Series sensor to a mobile smart phone according to the following steps:

1. Open **uPyxis®** Mobile App.
2. On **uPyxis®** Mobile App, pull down to refresh the list of available Pyxis devices.
3. If the connection is successful, the ST-730 Series and its Serial Number (SN) will be displayed (Figure 8).
4. Press on the **ST-730 Series sensor image**.

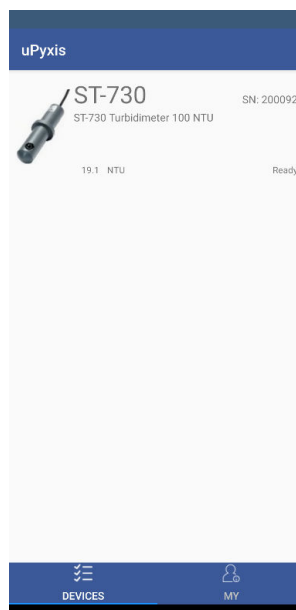

Figure 8.

5.3 Calibration Screen and Reading

When connected, the uPyxis® Mobile App will default to the **Calibration** screen. From the **Calibration** screen, you can perform calibrations by pressing on **Zero Calibration**, **Slope Calibration**, and **4-20mA Span**. Follow the screen instructions for each calibration step.

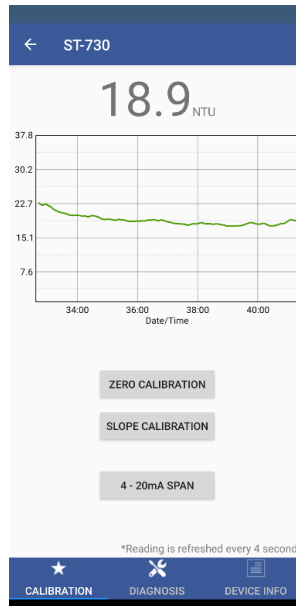

Figure 9.

5.4 Diagnosis Screen

From the **Diagnosis** screen, you can check the diagnosis condition as well as **Export & Upload**. This feature may be used for technical support when communicating with service@pyxis-lab.com.

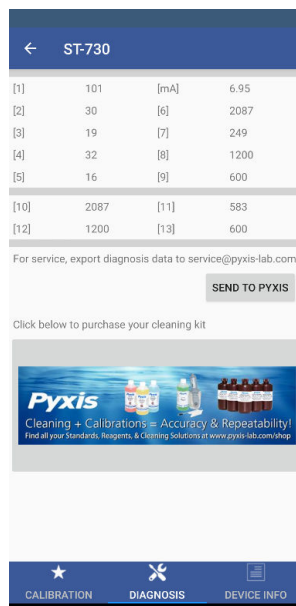

Figure 10.

5.5 Device Info Screen

From the **Device Info** screen. You can name the Device or Product.

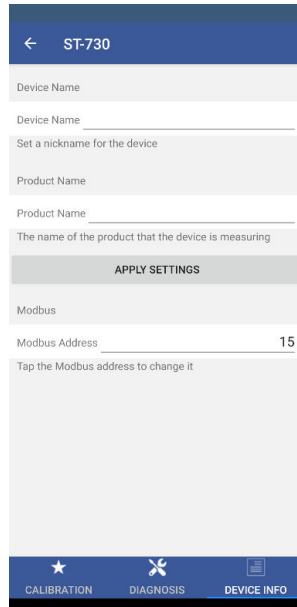

Figure 11.

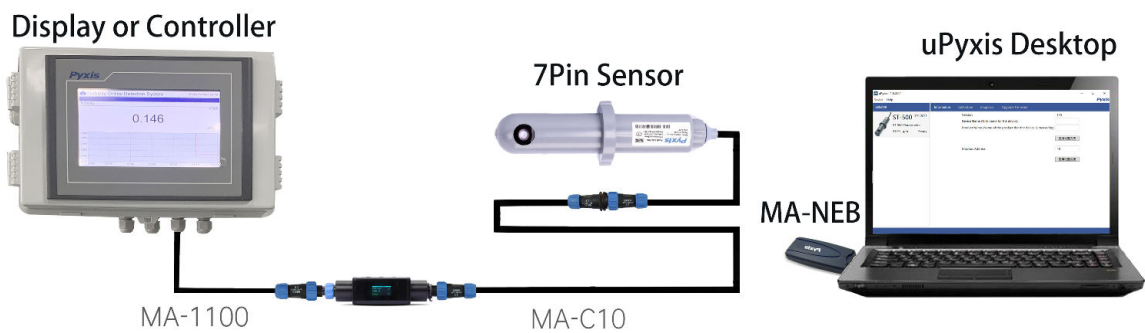

Figure 12. USB connection to ST-730 Series sensor with MA-WB, MA-NEB and uPyxis Desktop App.

6 Setup and Calibration with uPyxis® Desktop App

6.1 Install uPyxis® Desktop App

Download the latest version of **uPyxis®** Desktop software package from: <https://pyxis-lab.com/upyxis/> this setup package will download and install the Microsoft.Net Framework 4.5 (if not previously installed on the PC), the USB driver for the USB-Bluetooth adapter (MA-NEB), the USB-RS485 adapter (MA-485), and the main **uPyxis®** Desktop application. Double click the **uPyxis.Setup.exe** file to install.

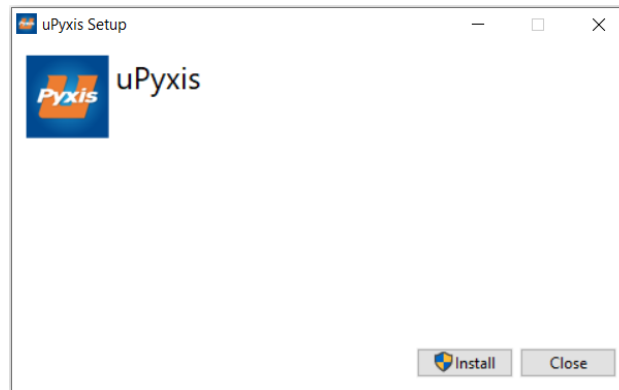

Figure 13. uPyxis® Desktop App installation

Click **Install** to start the installation process. Follow the screen instructions to complete the USB driver and uPyxis installation.

6.2 Connecting to uPyxis® Desktop App

Connect the ST-730 Series sensor to a Windows computer using either a Bluetooth/USB adapter (P/N: MA-NEB) or a USB-RS485 adapter (P/N: MA-485) according to the following steps:

1. Plug the Bluetooth/USB adapter or USB-RS485 adapter into a USB port in the computer.
2. Launch **uPyxis®** Desktop App.
3. On **uPyxis®** Desktop App, click Device→ **Connect via USB-Bluetooth** or **Connect via USB-RS485** (Figure 14).
4. If the connection is successful, the ST-730 Series and its Serial Number (SN) will be displayed in the left pane of the **uPyxis®** window.

NOTE After the sensor and Bluetooth is powered up, it may take up to 10 seconds for the adapter to establish the wireless signal for communication.

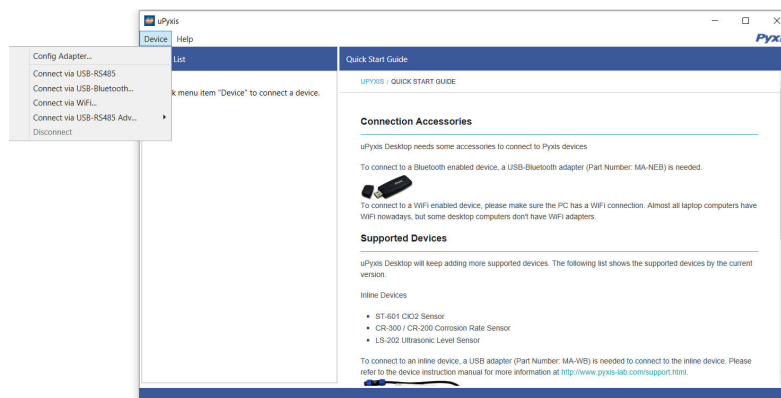

Figure 14.

6.3 Information Screen

Once connected to the device, a picture of the device will appear on the top left corner of the window and the uPyxis® Desktop App will default to the **Information** screen. On the **Information** screen you can set the information description for **Device Name** and **Product Name**, then click **Set** to save.

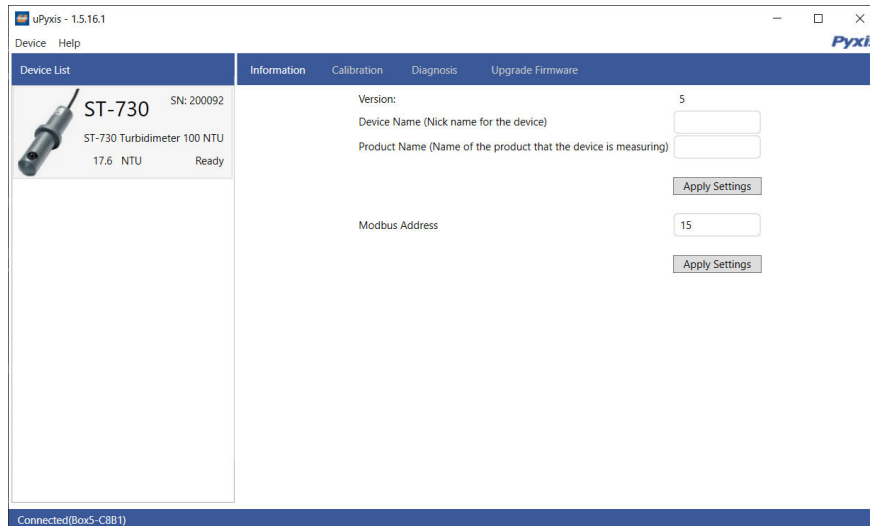

Figure 15.

6.4 Calibration Screen

To calibrate the device, click on **Calibration**. On the **Calibration** screen there are three calibration tabs, **Zero Calibration**, **Slope Calibration**, and **4-20mA Span**. The screen also displays the reading of the device. The reading refresh rate is every 4 seconds. Follow the screen instructions for each calibration step.



Figure 16.

6.5 Diagnosis Screen

After the device has been calibrated and installation has been completed, to check diagnosis, click on **Diagnosis**. When in the **Diagnosis** screen you can view the Diagnosis Condition of the device. This feature may be used for technical support when communicating with service@pyxis-lab.com.

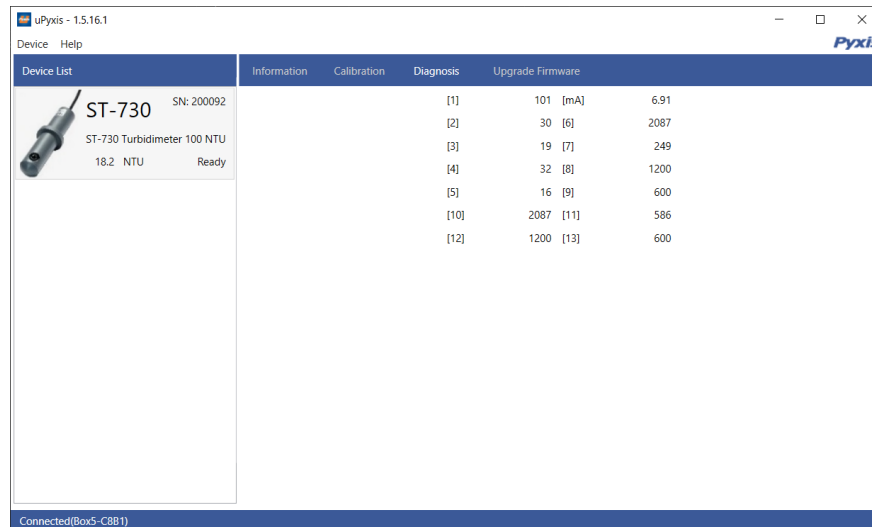

Figure 17.

7 Outputs

7.1 4–20mA Output Setup

The 4–20mA output of the ST-730 and ST-730SS sensor is scaled as:

- Turbidity:
 - 4 mA = 0 NTU
 - 20 mA = 100 NTU

The 4–20mA output of the ST-730B sensor is scaled as:

- Turbidity:
 - 4 mA = 0 NTU
 - 20 mA = 1,000 NTU

The 4–20mA output of the ST-731 sensor is scaled as:

- Turbidity:
 - 4 mA = 0 NTU
 - 20 mA = 10 NTU

The 4–20mA output of the ST-735 sensor is scaled as:

- Turbidity:
 - 4 mA = 0 NTU
 - 20 mA = 10,000 NTU

7.2 Adjusting 4–20mA Span

Users may adjust the output scale using 4–20mA Span to change the turbidity value corresponding to the 20 mA output via uPyxis®. For the uPyxis® Mobile App, press **4-20mA Span** found on the **Calibration and Reading Screen**, shown in Figure 17. For the uPyxis® Desktop App, click **4-20mA Span** found on the **Calibration Screen**, shown in Figure 18.

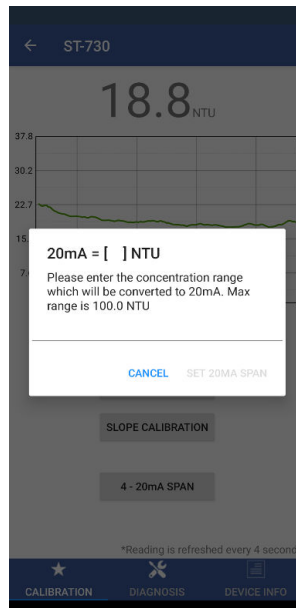

Figure 18.

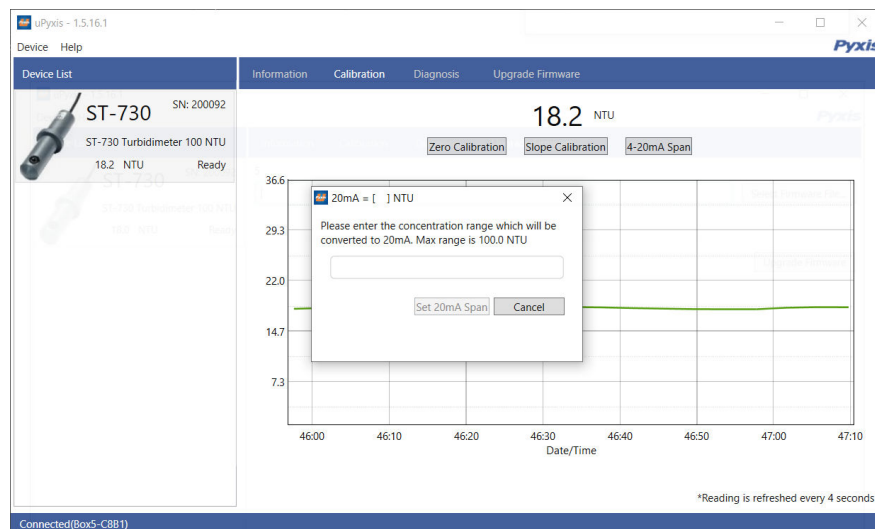

Figure 19.

7.3 Communication using Modbus RTU

The ST-730 Series sensor is configured as a Modbus slave device. In addition to the NTU value, many operational parameters, including warning and error messages, are available via a Modbus RTU connection. Contact Pyxis Lab Customer Service (service@pyxis-lab.com) for more information.

8 Sensor Maintenance and Precaution

When used to control product dosing, it is suggested that the automation system be configured to provide backup to limit potential product overfeeds, for example by limiting pump size or duration, or by alarming if the pumping rate exceeds a desired maximum limit.

The ST-730 Series sensor is designed to be easily removed, inspected, and cleaned if required. It is suggested that the ST-730 Series sensor be checked for fouling and cleaned on a monthly basis. Heavily contaminated waters may require more frequent cleanings. Cleaner water sources with less contamination may not require cleaning for several months.

8.1 Methods to Cleaning the ST-730 Series Sensor

Any equipment in contact with industrial cooling systems is subject to many potential foulants and contaminants. Our inline sensor cleaning solutions below have been shown to remove most common foulants and contaminants. A small, soft bristle brush, Q-Tips cotton swab, or soft cloth may be used to safely clean the sensor housing and the quartz optical sensor channel. These components and more come with a Pyxis Lab **Inline Probe Cleaning Solution Kit** (P/N: SER-01) which can be purchased at our online E-Store <https://pyxis-lab.com/product/st-series-probe-cleaning-kit/>



Figure 20. Inline Probe Cleaning Solution Kit

To clean the ST-730 Series sensor, soak the lower half of the sensor in 100 mL inline sensor cleaning solution for 30 minutes. Rinse the ST-730 Series sensor with distilled water and then check for the flashing blue light inside the ST-730 Series sensor quartz tube. If the surface is not entirely clean, continue to soak the ST-730 Series sensor for an additional 30 minutes. Use the small, soft bristle brush and Q-Tips cotton swabs as necessary to remove any remaining contaminants in the ST-730 Series sensor quartz tube.

8.2 Storage

Avoid long term storage at temperature over 100 °F. In an outdoor installation, properly shield the ST-730 Series sensor from direct sunlight and precipitation.

9 Troubleshooting

If the ST-730 Series sensor output signal is not stable and fluctuates significantly, make an additional ground connection — connect the clear (shield, earth ground) wire to a conductor that contacts the sample water electrically such as a metal pipe adjacent to the ST-730 Series tee.

Carry out routine calibration verification against a qualified turbidity standard. After properly cleaning the ST-730 Series sensor, carry out the zero point and slope calibration using the qualified turbidity standard. Pyxis Lab **Turbidity Standards** can be purchased at our online E-Store <https://pyxis-lab.com/product/turbidity-calibration-set-50-100-200-ntu/>



Figure 21. Turbidity Standards

10 Contact Us

Pyxis Lab, Inc

1729 Majestic Dr. Suite 5

Lafayette, CO 80026 USA

www.pyxis-lab.com

Phone: +1 (866) 203-8397

Email: service@pyxis-lab.com