



Series 96

User's Manual



1/16 DIN Temperature Controller with Custom Toolbar (patented)

User Levels:

- New User go to page 1.1
- Experienced User go to page 2.1
- Expert User go to page 2.1

Installers:

- Installation go to page 2.1
- Wiring go to page 3.1



U.S. English

1241 Bundy Blvd., P.O. Box 5580, Winona, Minnesota USA 55987-5580
Phone: (507) 454-5300, Fax: (507) 452-4507 <http://www.watlow.com>

0600-0002-0002 Rev G
July 2005

Supersedes: 0600-0002-0002 Rev F

Made in the U.S.A.
\$15.00

NOTE:

Details of a “Note” appear in the narrow margin on the outside or on the bottom of each page.

CAUTION:

Details of a “Caution” appear here in the narrow margin on the outside of each page.

WARNING:

Details of a “Warning” appear here in the narrow margin on the outside of each page.

Safety Information

We use note, caution and warning symbols throughout this book to draw your attention to important operational and safety information.

A “NOTE” marks a short message to alert you to an important detail.

A “CAUTION” safety alert appears with information that is important for protecting your equipment and performance. Be especially careful to read and follow all cautions that apply to your application.

A “WARNING” safety alert appears with information that is important for protecting you, others and equipment from damage. Pay very close attention to all warnings that apply to your application.

The safety alert symbol, , (an exclamation point in a triangle) precedes a general CAUTION or WARNING statement.

The electrical hazard symbol, , (a lightning bolt in a triangle) precedes an electric shock hazard CAUTION or WARNING safety statement.

Technical Assistance

If you encounter a problem with your Watlow controller, see the Troubleshooting Table in the Appendix and review all of your configuration information to verify that your selections are consistent with your application: inputs; outputs; alarms; limits; etc. If the problem persists after checking the above, you can get technical assistance from your local Watlow representative, or by dialing (507) 454-5300.

An applications engineer will discuss your application with you.

Please have the following information available when calling:

- Complete model number
- All configuration information
- User’s Manual
- Diagnostic Menu readings

Your Feedback

Your comments or suggestions on this manual are welcome. Please send them to: Technical Writer, Watlow Winona, 1241 Bundy Blvd., P.O. Box 5580, Winona, MN 55987-5580; phone: (507) 454-5300; fax: (507) 452-4507. *The Series 96 User’s Manual* is copyrighted by Watlow Winona, Inc., © July 2005, with all rights reserved. (2198)

T

Series 96 Table of Contents

Chapter 1: Overview	1.1	Chapter 6: Parameters	6.1
Chapter 2: Installation	2.1	Home Page	6.1
Chapter 3: Wiring	3.1	Operations Page	6.2
Input to Output Isolation	3.1	Setup Page	6.8
Power Wiring	3.1	Factory Page	6.18
Sensor Installation Guidelines	3.1	Chapter 7: Ramping	7.1
Input 1	3.2	Appendix.	A.1
Input 2	3.3	Troubleshooting Alarms and Errors	A.1
Output 1	3.4	Modbus™ Register Numbers	A.3
Output 2	3.5	Declaration of Conformity	A.4
Output 3	3.6	Product Specifications	A.5
Output 4	3.7	Ordering Information	A.7
Wiring Example	3.9	Index	A.8
Chapter 4: Navigation and Software.	4.1	Prompt Index	A.10
Keys and Displays	4.1	Required Parameter Setup Order	
Navigation	4.2inside back cover	
Software Map	4.3	Software Map	inside back cover
Basic Navigation for New Users.	4.4	Calibration Information	inside back cover
Chapter 5: Features.	5.1	Warranty and Returns Policy.	back cover
The System.	5.1		
Input	5.3		
Control Methods	5.5		
Alarms.	5.9		
Errors	5.10		
Communications	5.11		

1

Chapter One Overview

Introduction

With one universal input, a second auxiliary input and four outputs, the Series 96 can be programmed to perform temperature measurement, input event switching, remote set point input, heating, boost heating, cooling, alarms, digital communications, ramp and soak, and retransmit. These features make this controller ideally suited for applications involving plastics, packaging, semiconductor, food processing and lab equipment.

Set point ramping operations include two files with eight steps in each file. The files may be linked to create a single 16-step profile for varying ramp and soak needs.

With fast 10hz sampling, burst firing outputs, NEMA 4x front panel, and 0.1 percent accuracy, the Series 96 can easily handle some of the toughest application needs. The Series 96 is manufactured by ISO 9001-registered Watlow Winona with reliability backed by a three-year warranty.

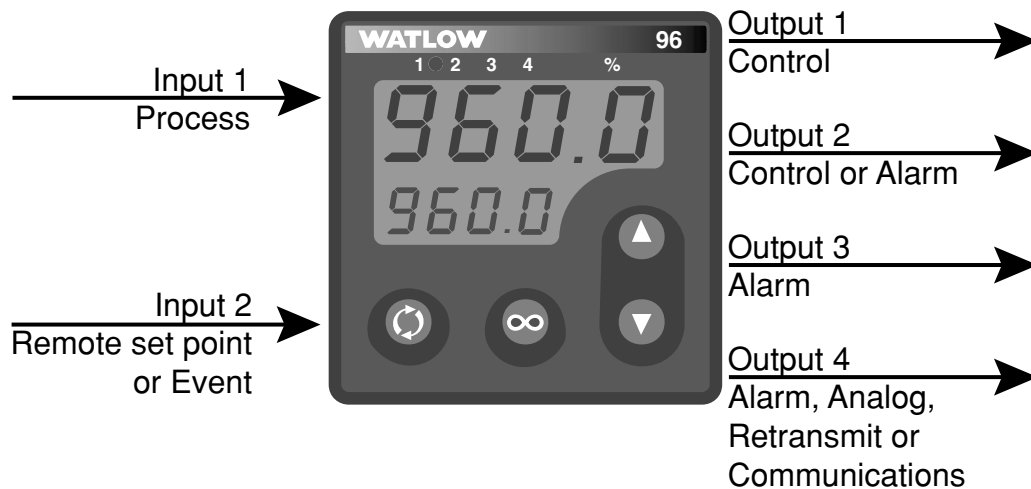

Figure 1.1 – Series 96 inputs and outputs.

2

Chapter Two Installation

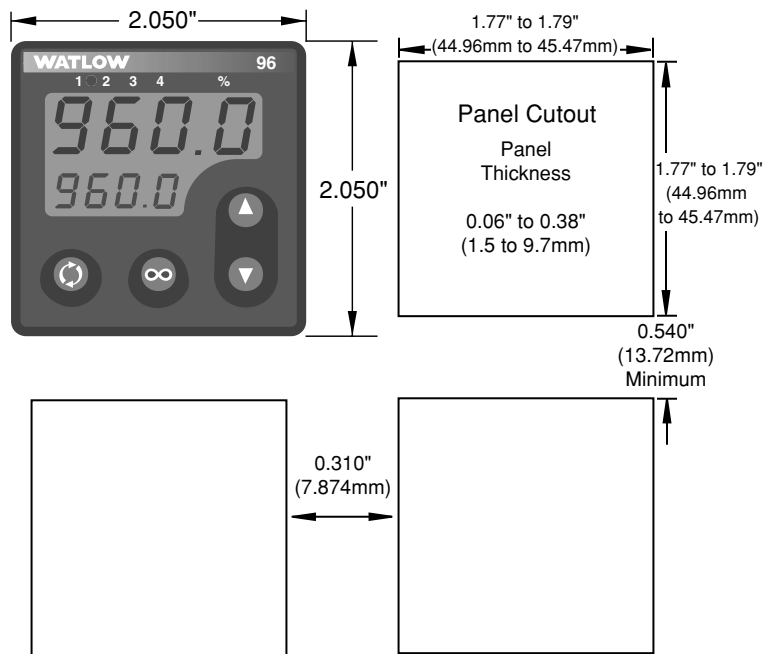

Figure 2.1 – Series 96 multiple panel cutout dimensions.

NOTE: Measurements between panel cutouts are the minimum recommended.

For rapid mounting, use Greenlee 1/16 DIN punch, die, draw stud, part number 60287, available from Grainger.

Installing the Series 96 Controller

Installing and mounting requires access to the back of the panel.

1. Make the panel cutout using the mounting template dimensions found in this chapter.
2. Check to see that the gasket is properly seated into the gasket channel on the front bezel and that it is not twisted. Make sure that the rounded surface of the gasket is the surface that is exposed from the gasket channel, as this is the surface that will mate to the panel surface. Insert the controller into the panel cutout.
3. With the controller inserted into the panel cutout, take the retention collar and slide it over the controller, making certain that the two locating holes in the retention collar are visible from the rear of the controller, with one hole pointing up and one pointing down. Then, take the mounting collar and slide it over the controller, making certain that one cantilever is pointing up and one is pointing down also. With one hand holding the controller and the other hand using a #2 Phillips screwdriver, tighten the two screws in the mounting collar until the gap between the bezel and panel surface is .025" maximum.

See the figure below. Make sure that you cannot move the controller back and forth in the cutout. If you can, you do not have a proper seal.



Figure 2.2a – Installing the controller.

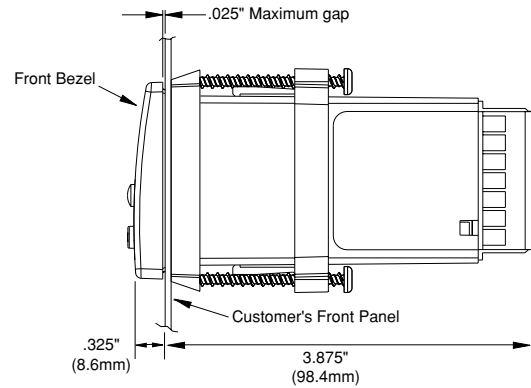

Figure 2.2b – Series 96 gap dimensions.



CAUTION: Follow the installation procedure exactly to guarantee a proper NEMA 4X seal. Make sure the gasket between the panel and the rim of the case is not twisted and is seated properly. Failure to do so could result in damage to equipment.

NOTE: Be careful not to over-tighten the screws. This may cause the mounting cover to fail. Over-tightening occurs when the front bezel is touching the customer's front panel.

Removing the Series 96 Controller

1. Hold the controller with one hand while using the other hand to loosen the screws with a #2 Phillips screwdriver until the end of the screw is flush or past the end of the cantilevers; see the figure below.
2. After the screws have been loosened, hold the controller with one hand while squeezing the two screws together with the other hand. Then simply slide the mounting collar off the controller.

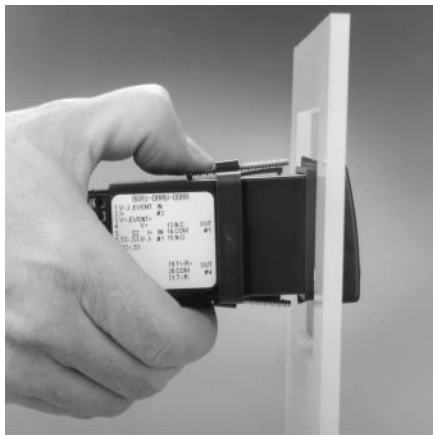

Figure 2.2c Removing the controller.

3

Chapter Three Wiring

NOTE:

It is advisable to check Output 1-4 hardware. These outputs may differ from those listed for the model number on the controller and described in this manual, indicating a customized hardware setup.



CAUTION:

If high voltage is applied to a low-voltage unit, irreversible damage will occur.



WARNING:

To avoid damage to property and equipment, and/or injury or loss of life, use National Electric Code (NEC) standard wiring practices to install and operate the Series 96. Failure to do so could result in injury or death.



CAUTION:

Maintain isolation between input 1 and input 2 to prevent a ground loop. A ground loop may cause incorrect readings, dashes across the upper display or the display of error codes. Failure to follow this guideline could result in damage to equipment and product.

Input-to-Output Isolation

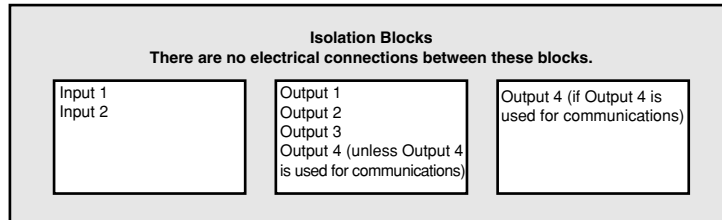

Figure 3.1a Isolation blocks.

Power Wiring

100 to 240V~ (ac), nominal (85 to 264 actual) 96 A _ - - - - -
24 to 28V≈ (ac/dc), nominal (21 to 30 actual) 96 B _ - - - - -

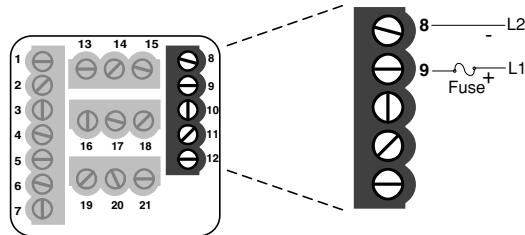

Figure 3.1b Power wiring.

Sensor Installation Guidelines

Thermocouple inputs: Extension wire for thermocouples must be of the same alloy as the thermocouple to limit errors.

When using a process signal (4-20mA, 0-5V≈ [dc], etc.) for the remote set point or a voltage input for the digital input 2, use an ungrounded or isolated thermocouple. If a grounded thermocouple is required, the signal to input 2 must be isolated to prevent possible ground loops.

RTD input: Each 1Ω of lead wire resistance can cause a +2°F error when using a two-wire RTD. A three-wire RTD sensor overcomes this problem. All three wires must have the same electrical resistance (i.e., same gauge, same length, multi-stranded or solid, same metal).

Process input: Isolation must be maintained between input 1 and input 2. If both input 1 and input 2 are process signals, a separate power supply and transmitter must be used for each input. These inputs must be electrically isolated from one another to prevent ground loops.

Input 1 Wiring

NOTE:

Successful installation requires five steps:

- Choose the controller's hardware configuration and model number (Appendix);
- Choose a sensor (Chapters Three and Six, and Appendix);
- Install the controller (Chapter Two);
- Wire the controller (Chapter Three) and
- Configure the controller (Chapters Four, Five and Six).



WARNING:

To avoid potential electric shock and damage to property and equipment, use National Electric Code (NEC) safety practices when wiring and connecting this unit to a power source and to electrical sensors or peripheral devices. Failure to do so could result in injury or death.



CAUTION:

Maintain isolation between input 1 and input 2 to prevent a ground loop. A ground loop may cause incorrect readings, dashes across the upper display or the display of error codes. Failure to follow this guideline could result in damage to equipment and product.

Figure 3.2a – Thermocouple

Available on all units
Impedance: 20MΩ

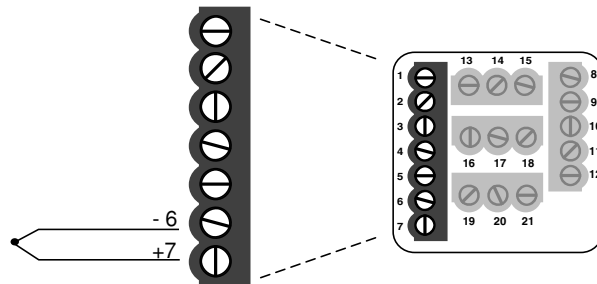

Figure 3.2b – RTD (2- or 3-Wire) 100Ω Platinum

Available on all units

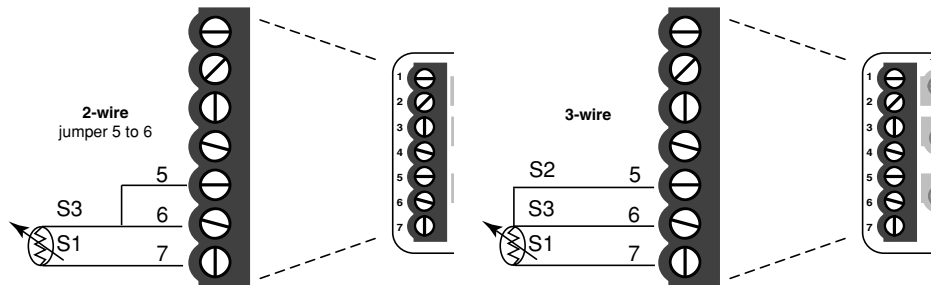

Figure 3.2c – **0-5V_{DC}, 1-5V_{DC} or 0-10V_{DC} (dc) Process

Available on all units
Input impedance: 20kΩ

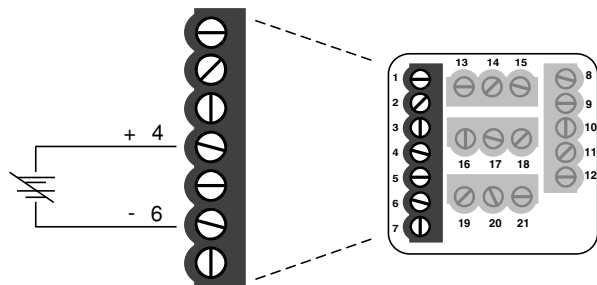

Figure 3.2d – **0-20mA or 4-20mA Process

Available on all units
Input impedance: 100Ω



****CAUTION:**

Process input does not have sensor break protection. Outputs can remain full on.

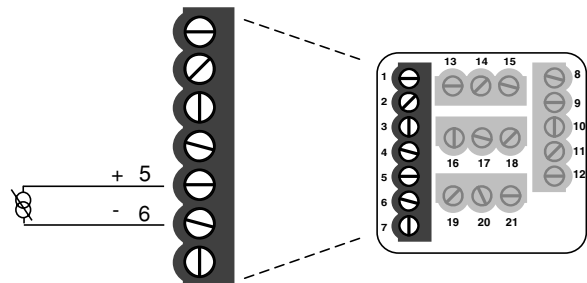

Input 2 Wiring

Figure 3.3a – ****0-5V_{rms}, 1-5V_{rms} or 0-10V_{rms} (dc) Process**

Universal signal conditioner
 96_1 - - - - -
 Input impedance: 20kΩ

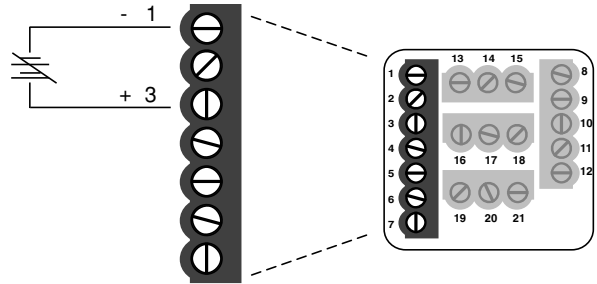

WARNING:

To avoid damage to property and equipment, and/or injury or loss of life, use National Electric Code (NEC) standard wiring practices to install and operate the Series 96. Failure to do so could result in injury or death.



CAUTION:

Maintain isolation between input 1 and input 2 to prevent a ground loop. A ground loop may cause incorrect readings, dashes across the upper display or the display of error codes. Failure to follow this guideline could result in damage to equipment and product.



****CAUTION:**

Process input does not have sensor break protection. Outputs can remain full on.

Figure 3.3b – ****0-20mA or 4-20mA Process**

Universal signal conditioner
 96_1 - - - - -
 Input impedance: 100Ω

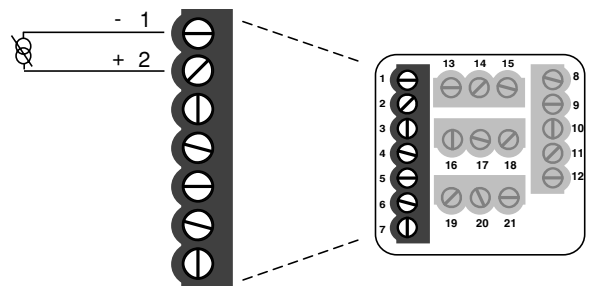
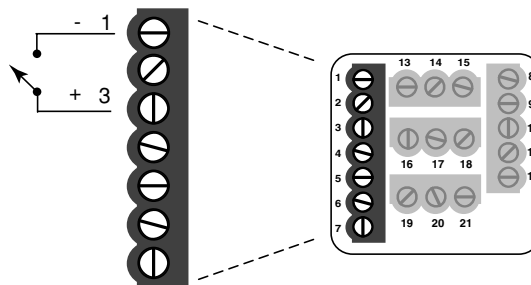
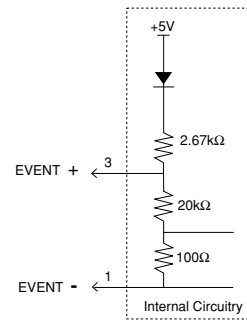

Figure 3.3c – **Digital Event**

96_1 - - - - -
Voltage input
 3-36V_{rms} (dc) Event Input High State
 0-2V_{rms} (dc) Event Input Low State
Contact closure
 0-2kΩ Event Input Low State
 > 23kΩ Event Input High State



Output 1 Wiring

Figure 3.4a – AC Outputs

NOTE:

Successful installation requires five steps:

- Choose the controller's hardware configuration and model number (Appendix);
- Choose a sensor (Chapters Three and Six, and Appendix);
- Install the controller (Chapter Two);
- Wire the controller (Chapter Three) and
- Configure the controller (Chapters Four, Five and Six).

NOTE:

Switching inductive loads (relay coils, solenoids, etc.) with the mechanical relay, switched dc or solid-state relay output options requires use of an R.C. suppressor.

Watlow carries the R.C. suppressor Quencharc brand name, which is a trademark of ITW Paktron. Watlow Part No. 0804-0147-0000.

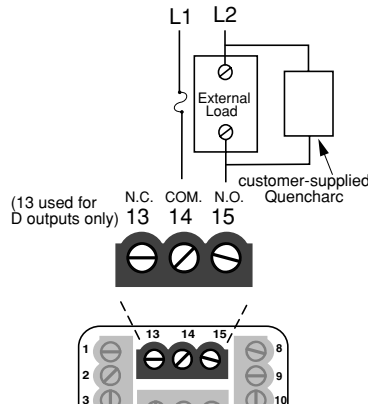

- Electromechanical relay without contact suppression

96 ___ - D _____

Form C, 2 amps, off-state impedance: 31MΩ

- Solid-state relay without contact suppression

96 ___ - K _____

0.5 amps, off-state impedance: 31MΩ

Figure 3.4b – Switched DC, Open Collector

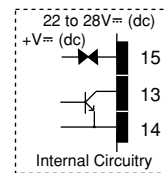
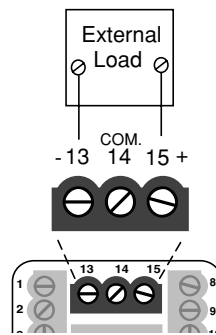

96 ___ - C _____

- Switched dc configuration

Supply current limited to 30mA

- Open collector configuration

Maximum voltage 42V= (dc)

Maximum current 200mA

Figure 3.4c – 0-20mA and 4-20mA Process

96 ___ - F _____

Maximum load impedance: 800Ω

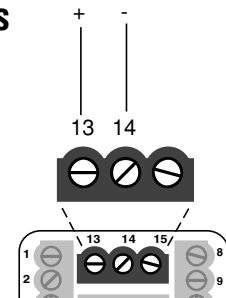
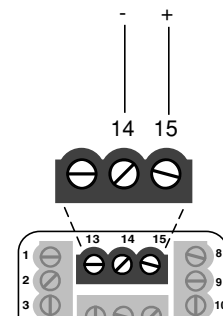

Figure 3.4d – 0-5V=, 1-5V= and 0-10V= (dc) Process

96 ___ - F _____

Minimum load impedance: 1kΩ



Output 2 Wiring

Figure 3.5a – AC Outputs

NOTE:

Switching inductive loads (relay coils, solenoids, etc.) with the mechanical relay, switched dc or solid-state relay output options requires use of an R.C. suppressor.

Watlow carries the R.C. suppressor Quencharc brand name, which is a trademark of ITW Paktron. Watlow Part No. 0804-0147-0000.

- Electromechanical relay without contact suppression

96 _ _ - - D _ _ _ - _ _ _ _

Form C, 2 amps,
off-state impedance:
31M Ω

- Solid-state relay without contact suppression

96 _ _ - - K _ _ _ - _ _ _ _

0.5 amps, off-state
impedance: 31M Ω

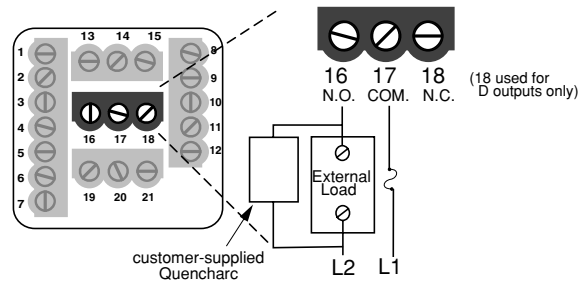

Figure 3.5b – Switched DC, Open Collector

96 _ _ - - C _ _ _ - _ _ _ _

Open Collector

Max. voltage: 42V $\overline{=}$ (dc)

Max. current: 200mA

Switched DC

Max. dc supply current:
30mA

Supply voltage: 22 to 28V $\overline{=}$ (dc)

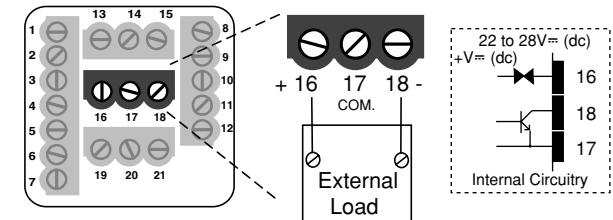

WARNING:

To avoid damage to property and equipment, and/or injury or loss of life, use National Electric Code (NEC) standard wiring practices to install and operate the Series 96. Failure to do so could result in injury or death.

Figure 3.5c – 0-20mA and 4-20mA Process

96 _ _ - - F _ _ _ - _ _ _ _

Maximum load
impedance: 800 Ω

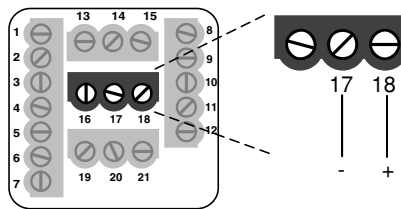
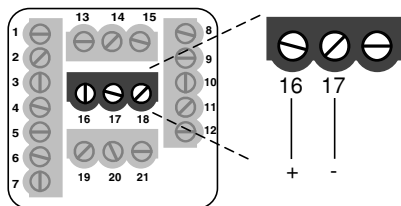

Figure 3.5d – 0-5V $\overline{=}$, 1-5V $\overline{=}$ and 0-10V $\overline{=}$ (dc) Process

96 _ _ - - F _ _ _ - _ _ _ _

Minimum load
impedance: 1k Ω



Output 3 Wiring

Figure 3.6 – AC Outputs

Electromechanical relay without contact suppression

96 _ _ _ _ D _ _ _ _ _

Form C, 2 amps, off-state impedance: 31MΩ

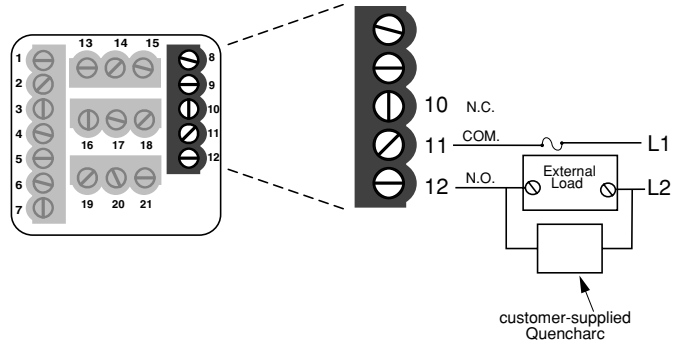

NOTE:

Successful installation requires five steps:

- Choose the controller's hardware configuration and model number (Appendix);
- Choose a sensor (Chapters Three and Six, and Appendix);
- Install the controller (Chapter Two);
- Wire the controller (Chapter Three) and
- Configure the controller (Chapters Four, Five and Six).

NOTE:

Switching inductive loads (relay coils, solenoids, etc.) with the mechanical relay, switched dc or solid-state relay output options requires use of an R.C. suppressor.

Watlow carries the R.C. suppressor Quencharc brand name, which is a trademark of ITW Paktron. Watlow Part No. 0804-0147-0000.



WARNING:

To avoid damage to property and equipment, and/or injury or loss of life, use National Electric Code (NEC) standard wiring practices to install and operate the Series 96. Failure to do so could result in injury or death.

Output 4 Wiring

NOTE:

Switching inductive loads (relay coils, solenoids, etc.) with the mechanical relay, switched dc or solid-state relay output options requires use of an R.C. suppressor.

Watlow carries the R.C. suppressor Quencharc brand name, which is a trademark of ITW Paktron. Watlow Part No. 0804-0147-0000.



WARNING:

To avoid damage to property and equipment, and/or injury of loss of life, use National Electric Code (NEC) standard wiring practices to install and operate the Series 96. Failure to do so could result in injury or death.

Figure 3.7a – AC Outputs

Electromechanical relay without contact suppression

96 - - - - D - - - - -

Form C, 2 amps, off-state impedance: 31MΩ

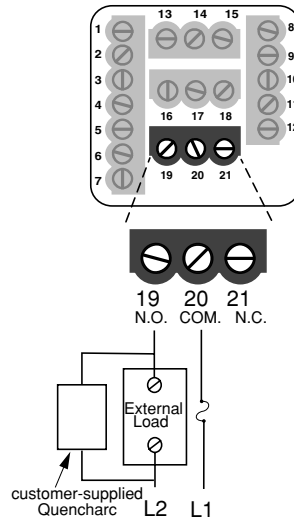

Figure 3.7b – Communications and Retransmit Option

EIA/TIA-232

EIA/TIA-485

Retransmit Option

96 - - - - R - - - - -

96 - - - - U - - - - -

96 - - - - M - - - - -

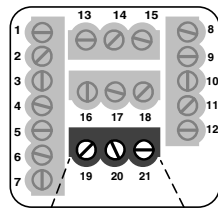

19 T out
20 COM.
21 R in

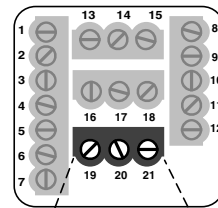

19 T-/R-
20 COM.
21 T+/R+

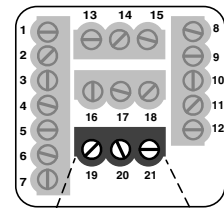

19 V out
20 COM.
21 I out

V out: 1,000Ω minimum load impedance.
I out: 800Ω maximum load impedance.

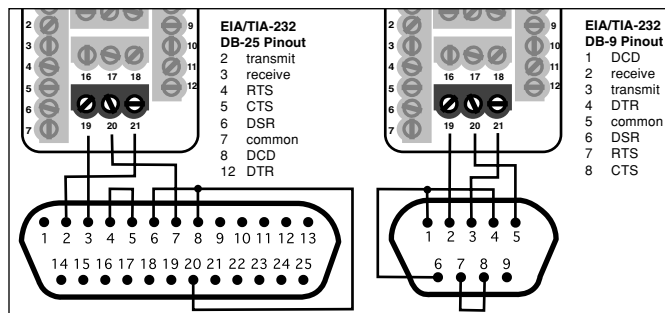
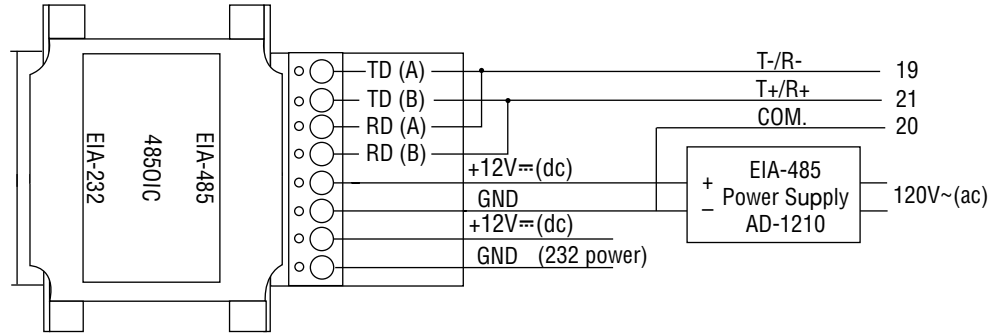

Figure 3.8a – EIA-232 to EIA-485 Conversion



WARNING:

To avoid damage to property and equipment, and/or injury or loss of life, use National Electric Code (NEC) standard wiring practices to install and operate the Series 96. Failure to do so could result in injury or death.



B&B Converter (B&B Electronics Manufacturing Company, [815] 433-5100).

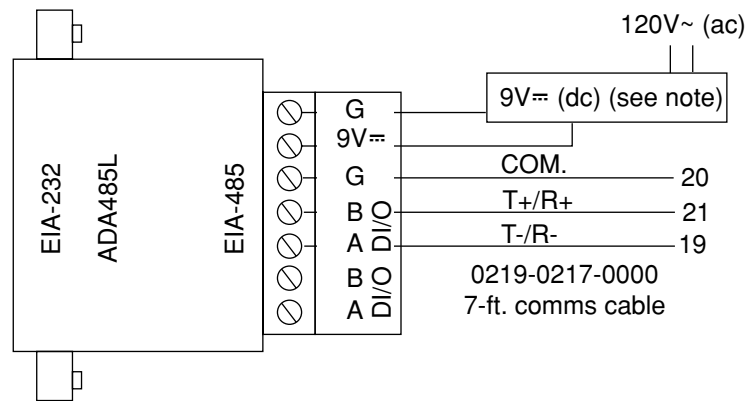

CMC Converter (CMC Connecticut Micro-Computer, Inc., 800-426-2872).

NOTE:

The CMC converter requires an external power supply when used with a laptop computer.

Figure 3.8b – Termination for EIA-232 to EIA-485 Converter

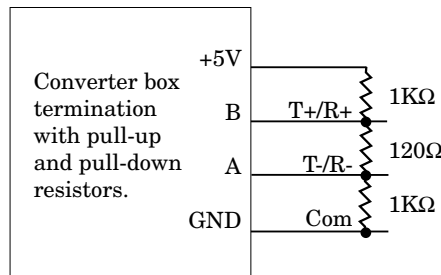

If the system does not work properly, it may need termination resistors at each end of the network. A typical installation would require a 120-ohm resistor across the transmit/receive terminals (19 and 21) of the last controller in the network and the converter box or serial card. Pull-up and pull-down resistors may be needed to maintain the correct voltage during the idle state.

NOTE: For more information about communicating with Watlow controllers, go to www.watlow.com and download the Data Communications Reference: Electronic User's Manual. It is located under Literature, User's Manuals, English and search on *data communications reference*.

Wiring Example



WARNING:

To avoid potential electric shock and damage to property and equipment, use National Electric Code (NEC) safety practices when wiring and connecting this unit to a power source and to electrical sensors or peripheral devices. Failure to do so could result in injury or death.

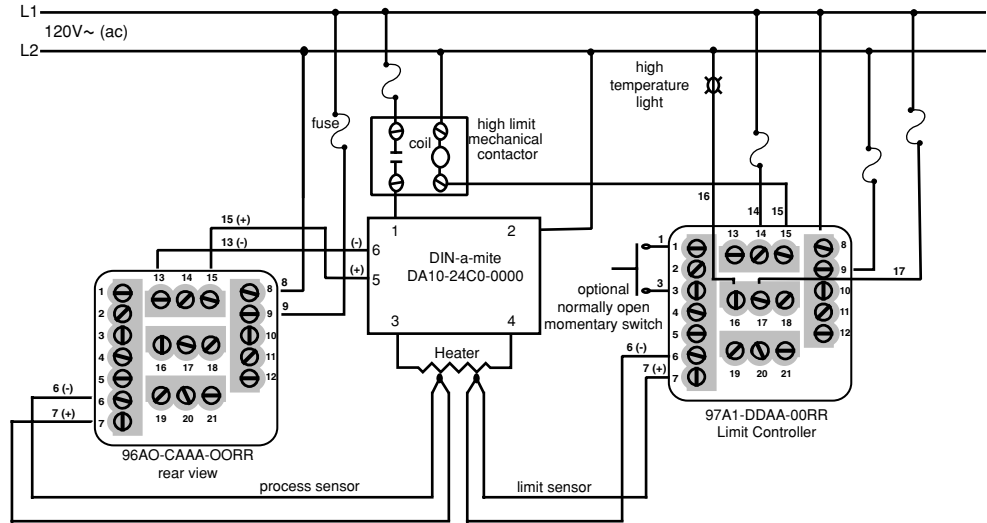

WARNING:

Install high- or low-temperature-limit control protection in systems where an over-temperature fault condition could present a fire hazard or other hazard. Failure to install temperature-limit control protection where a potential hazard exists could result in damage to equipment and property.

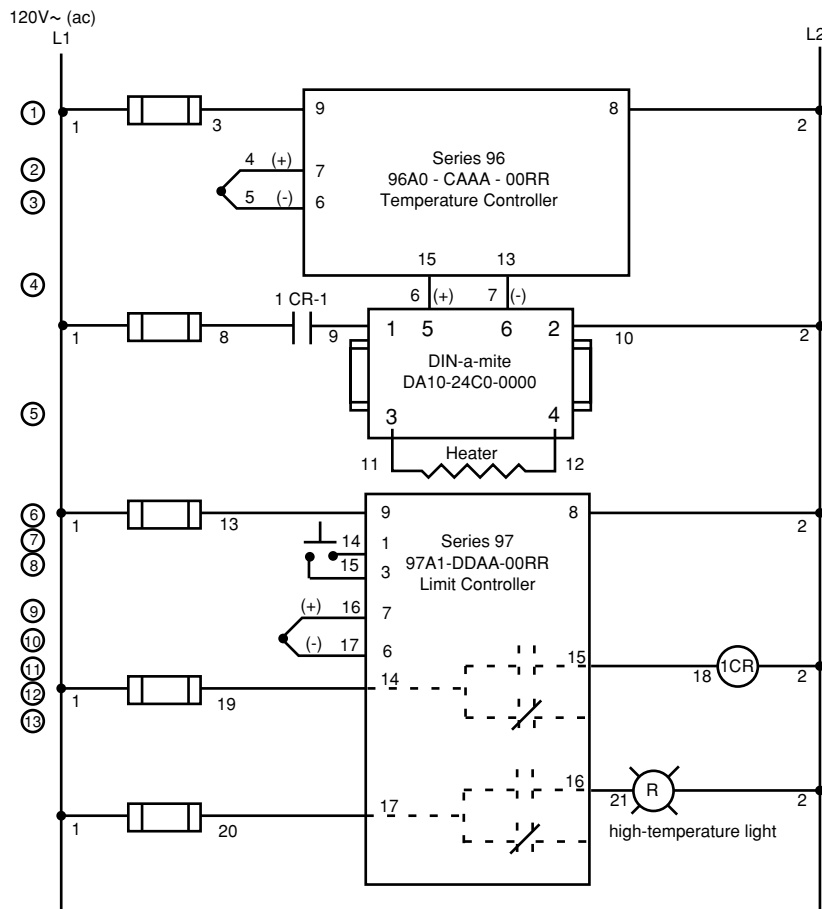

Figure 3.9 – System wiring example.

4

Chapter Four Navigation and Software

Keys and Displays

This chapter explains keys, displays and navigation skills, and presents charts showing how to accomplish basic tasks, including setting up the Custom Menu, which is unique to the Series 96. You'll also find a complete software map.

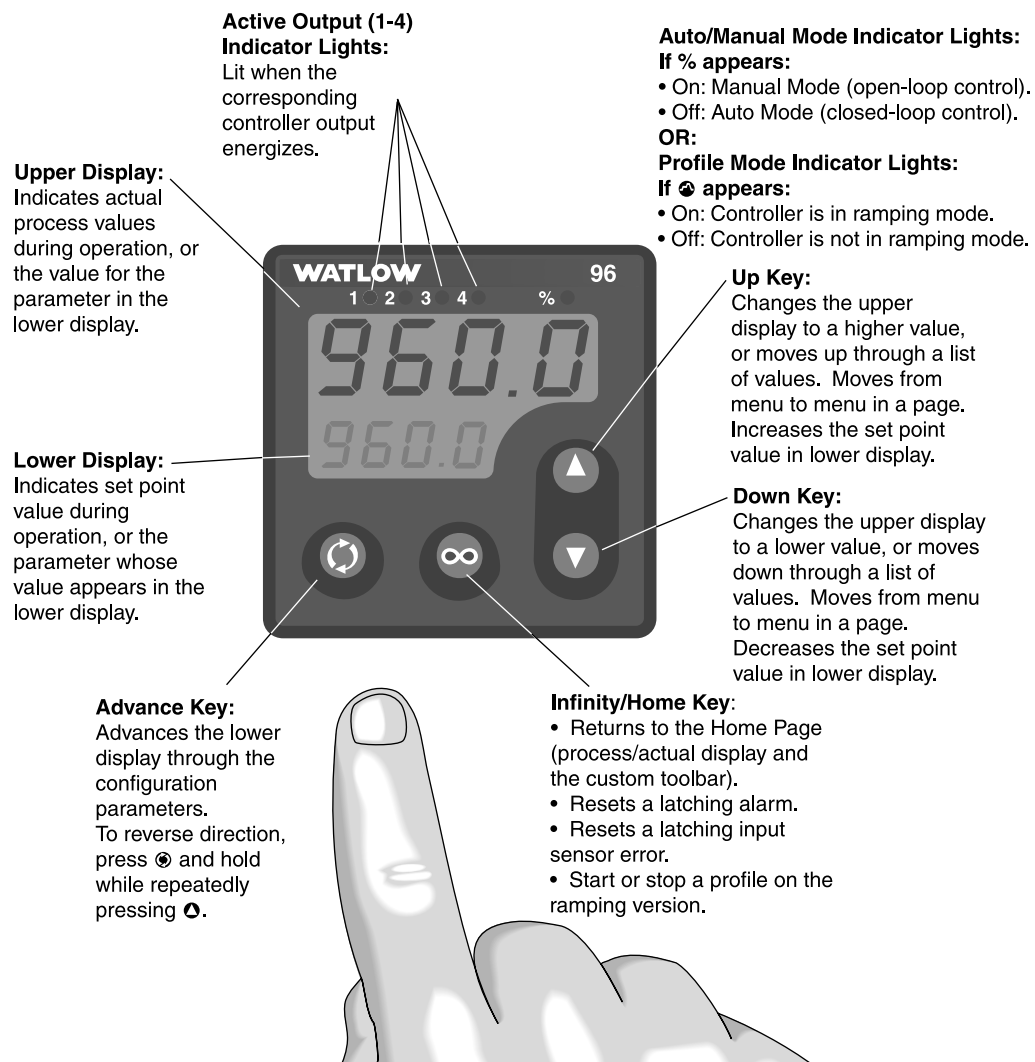

Figure 4.1 – Series 96 keys and displays.

Navigating the Series 96

Choose a page (Operation, Setup or Factory) and press its key sequence. The page appears in the lower display.



- **Operation Page:** Press and keys together for 3 seconds.



- **Setup Page:** Press and keys together for 6 seconds.



- **Factory Page:** Press and keys together for 6 seconds.



- **Home Page:** From anywhere, press the key.

Press or to find a specific menu in a page. The menu appears in the upper display and the page remains in the lower display.

Press to enter the list of parameters in the menu displayed. The menu's parameters appear in the lower display and the values in the upper. To go backward through the parameter list press and together.

Press or to select a value, either alpha or numeric.

Press to set the value and go to the next parameter.

Series 96 Software Map

Home Page

- 96** Process 1 Value
- 96** Set Point Value, Remote Set Point Value or Percent Output Value
- 96** Custom Menu**...
- PI**

Program Menu*

(see pg. 7.1)

Operations Page

MON Monitor Menu

- OPER** Operations Page
- PR2** Process 2**
- Pcnt** Percent Output
- rPSP** Ramping Set Point**
- ESL** Event Input Status

USER User Menu

- OPER** Operations Page
- A-MAN** Auto-Manual Operations Mode**
- AUT** Auto-tune
- RESP** Auto-tune Set Point
- SP2** Set Point 2**
- ESP** Event Set Point**
- L-r** Local or Remote Mode**
- CAL1** Calibration Offset

PID1 PID 1 Menu

- OPER** Operations Page
- Pb1** Propband 1
- IE1** Integral 1
- RE1** Reset 1
- DE1** Derivative 1
- RA1** Rate 1
- brS1** Burst 1
- CT1** Cycle Time 1
- hYS1** Hysteresis 1
- db1** Dead Band 1

PID2 PID 2 Menu

- OPER** Operations Page
- Pb2** Propband 2
- IE2** Integral 2
- RE2** Reset 2
- DE2** Derivative 2
- RA2** Rate 2
- brS2** Burst 2
- CT2** Cycle Time 2
- hYS2** Hysteresis 2
- db2** Dead Band 2

ALM Alarm Menu

- OPER** Operations Page
- R2Lo** Alarm 2 Low
- R2Hi** Alarm 2 High
- R3Lo** Alarm 3 Low
- R3Hi** Alarm 3 High
- R4Lo** Alarm 4 Low
- R4Hi** Alarm 4 High

Setup Page

INP1 Input 1 Menu

- SEE** Setup Page
- SEN1** Sensor Type
- IN1** Input Type 1
- RL1** Range Low 1
- rh1** Range High 1
- dEC1** Decimal 1
- FEL1** Input Software Filter 1

INP2 Input 2 Menu

- SEE** Setup Page
- IN2** Input 2**
- RL2** Range Low 2**
- rh2** Range High 2**
- CAL2** Calibration Offset 2**
- EFN** Event Function
- ECN** Event Condition
- AbSP** Abort Set Point*

OUT1 Output 1 Menu

- SEE** Setup Page
- DE1** Output 1
- PRC1** Process Type 1

OUT2 Output 2 Menu

- SEE** Setup Page
- DE2** Output 2
- PRC2** Process Type 2
- REY2** Alarm Type 2
- RhY2** Alarm Hysteresis 2
- LRE2** Latching 2
- SIL2** Silencing 2
- Sid2** Alarm Active Sides 2
- L9C2** Alarm Logic 2
- Rnu2** Alarm Annunciation 2

OUT3 Output 3 Menu

- SEE** Setup Page
- DE3** Output 3
- REY3** Alarm Type 3
- RhY3** Alarm Hysteresis 3
- LRE3** Latching 3
- SIL3** Silencing 3
- Sid3** Alarm Active Sides 3
- L9C3** Alarm Logic 3
- Rnu3** Alarm Annunciation 3

OUT4 Output 4 Menu

- SEE** Setup Page
- DE4** Output 4
- REY4** Alarm Type 4
- RhY4** Alarm Hysteresis 4
- LRE4** Latching 4
- SIL4** Silencing 4
- Sid4** Alarm Active Sides 4
- L9C4** Alarm Logic 4
- Rnu4** Alarm Annunciation 4
- RouE** Analog Output 4
- PRC4** Process Type 4
- Rhi** Analog Output High
- RLo** Analog Output Low
- RCAL** Analog Output Offset
- BRUD** Baud Rate
- ADDR** Address

Note: What you see depends on the options and settings included in your controller.

GLBL Global Menu

- SEE** Setup Page
- UNIT** Units Type
- C-F** C or F
- ERR** Input Error Latching
- FAIL** Failure Mode**
- MAN** Manual Default Power**
- PLSP** Power Limit Set Point
- PLA** High Power Limit Above
- PLB** High Power Limit Below
- rP** Ramping Mode**
- rPS** Ramp Scale**
- rRE** Ramp Rate**
- OPLP** Open Loop Detect
- PtYP** Program Type*

Factory Page

CUSE Custom Menu**

- FctY** Factory Page
- PI**
- P2**
- P3**
- P4**
- P5**
- P6**
- P7**
- P8**
- P9**
- P10**
- P11**
- P12**
- P13**
- P14**
- P15**
- P16**

LOC Lockout Menu

- FctY** Factory Page
- SP** Set Point Lock
- PRO9** Program Menu Lock*
- CUSE** Custom Menu Lock**
- OPER** Operations Page Mode
- SEE** Setup Page Lock
- CAL** Calibration Menu Lock

DIAG Diagnostics Menu

- FctY** Factory Page
- MDL** Model Number
- dMEE** Date of Manufacture
- SNI** Serial Number 1
- SNI2** Serial Number 2
- SoFE** Software ID Number
- IEY2** Input Type 2 _
- REV** Software Revision
- DEY1** Output 1 Hardware
- DEY2** Output 2 Hardware
- DEY3** Output 3 Hardware
- DEY4** Output 4 Hardware
- TOU** Test Output
- d15P** Test Displays
- HR5** High Resolution
- R7b** Ambient Temperature
- Rcnt** Ambient A-D Counts
- cnt1** Channel 1 A-D Counts
- cnt2** Channel 2 A-D Counts
- ESH** Communications Test/Troubleshooting
- LINE** Line Frequency

The Factory Page includes calibration parameters that are not necessary for everyday use of the controller.

*Added if ramping version of controller is selected (96__-__-AA__).





**Removed if ramping version of controller is selected (96__-__-AA__).

Basic navigation for new users

Use this example task to learn how to use the keys and displays. For more information about the control features available in the Series 96, see Chapter Five. For a table of all parameters and values, see Chapter Six.

Configure the controller

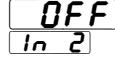
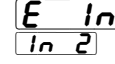
To configure the controller to suit your application, go to the Setup Page, enter the menus and set the parameters for the system, its inputs and outputs.

Do this	Press these keys	You'll see*
1 Go to the Setup Page from the Home Page.	▲Up-arrow and ▼Down-arrow keys for 6 seconds.	After 3 seconds the Operations Page appears in the lower display; after 6 seconds the Setup Page appears in the lower display. A menu is in the upper display. 
2 Choose a menu to enter.	▲Up-arrow key.	The Setup Page remains in the lower display while menu names appear in the upper display. 
3 Go to a parameter.	⏩Advance key.	The menu's parameters appear in the lower display and the values appear in the upper display.  (Note: When you enter a menu, the display changes. Instead of the Setup Page and menu, you see parameter and value.)
4 Choose a value.	▲Up-arrow key, until you reach the desired value.	Values appear in the upper display when the parameter is in the lower display. 
5 Set a value and go on to the next parameter.	⏩Advance key (when the chosen value is displayed).	You will see the chosen value in the upper display. After pressing the Advance key, the next parameter appears in the lower display, with one of its values in the upper display. Values auto-enter after 5 seconds. 
Summary	To make a selection or choice:	Press ▲Up-arrow key or ▼Down-arrow key.
	To move or change location in a page or menu:	Press ⏩Advance key or ⏪Home/Infinity key.

*What you see depends on the options included in your controller.

5

Chapter Five Features

The System

Custom Menu (patented)

The Custom Menu provides you with a shortcut to monitor, tune or change the parameter values that you use most often. You can go directly to the Custom Menu in the Home Page by pressing **☉**. This provides a fast and convenient way to monitor and change settings.

You can create your own Custom Menu with as many as 16 of the active parameters from the list below. When a parameter is placed in the Custom Menu it is accessible through both the Custom Menu and its original menu. If you change a parameter in the Custom Menu it is automatically changed in its original menu. If you change a parameter in its original menu it is automatically changed in the Custom Menu.

If you do not assemble a Custom Menu, four default parameters will automatically appear in the Custom Menu.

To change the list of parameters in the Custom Menu, press both the **☉** and **☺** keys for 6 seconds. This will take you to the Factory Page. The Custom Menu **[CUSE]** is the first menu on the Factory page. Press the **☉** key once to go to the first selection in the menu. The parameter choices will appear in the top display and the selection number will appear in the bottom display. Use the **▲** or the **▼** key to change the selected parameter in the top display. If you do not want a parameter to appear for that location, select **[none]**. To change the other 15 selections, press **☉** to select a place in the menu, **[P 1]** to **[P 16]**, in the bottom display and use the **▲** or the **▼** key to change the parameter selected in the top display.

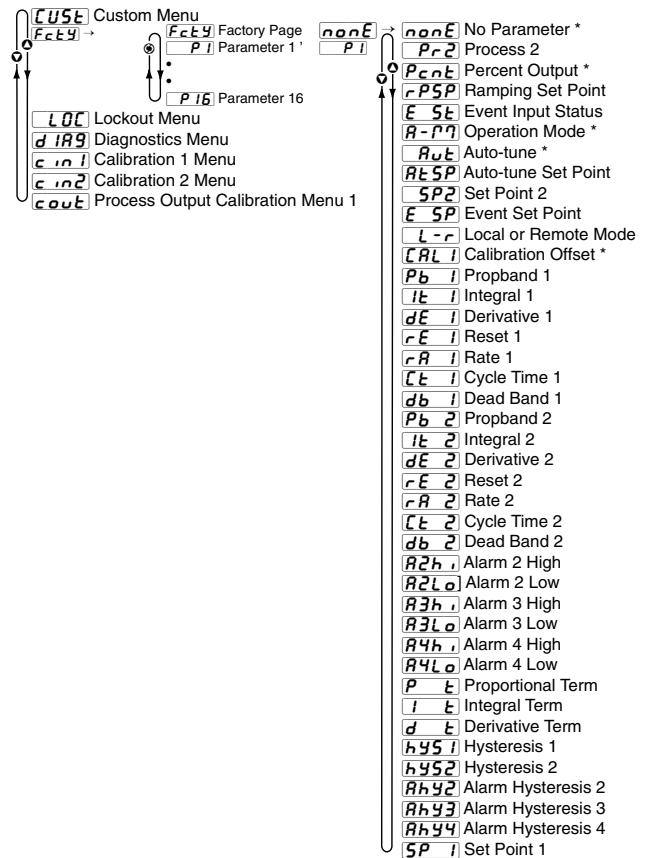

Figure 5.1 – Parameters available for the Custom Menu (*default selections).

Note: The Custom Menu will not appear if the ramping software option has been ordered (96XX-XXXX-AAXX).

Auto-tune

Auto-tuning allows the controller to explore the responsiveness of the system to determine an effective set of parameters for PID control. To do this it crosses an auto-tune set point several times, then controls at the normal set point using the new parameters.

Use Auto-tune Set Point **[A_TSP]** (User Menu) to select the temporary set point, as a percentage of the normal set point, that the controller will tune to. Initiate or cancel the auto-tune process with Initiate Auto-tune **[A_{UT}]** (User Menu).

In heat-only or cool-only modes the only option is **[t_{unE}]**.

In heat/cool or cool/heat modes there are three tuning options:

[t_{unE}] tunes both heat and cool at the same time. This is appropriate if the system typically operates with both heat and cool contributing, such as in an environmental chamber.

[P_{id1}] tunes just PID set 1. This is appropriate for tuning the heat of an extruder application in the endothermic mode.

[P_{id2}] tunes just PID set 2. This is appropriate for tuning the cool set of an extruder application in the exothermic mode.

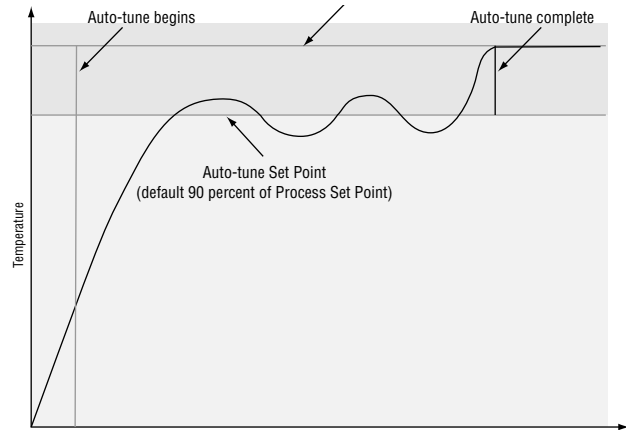

Figure 5.2a Auto-tuning.

CAUTION: Choose an auto-tune set point value that will protect your product from possible damage from overshoot or undershoot during the auto-tuning oscillations. If the product is sensitive, carefully select the auto-tune set point to prevent product damage.

Power Limit

A high side power limit and low side power limit set the maximum output power within two ranges.

A low side power limit limits the output to a percentage of the maximum output power while the process temperature or value is below the power limit set point.

The high side power limit limits the output to a percentage of the maximum output power while the process temperature or value is above the power limit set point.

The power limits work the same way in a cooling applications, but the negative values are converted to absolute (positive) values for determining whether the range is below or above the power limit set point.

The low side power limit can be viewed or changed with High Power Limit Below **[P_Lb]** (Global Menu).

The high side power limit can be viewed or changed with High Power Limit Above **[P_LA]** (Global Menu).

The power limit set point can be viewed or changed with Power Limit Set Point **[P_LSP]** (Global Menu).

The actual output power can be viewed with Percent Output **[P_{cnt}]** (Monitor Menu).

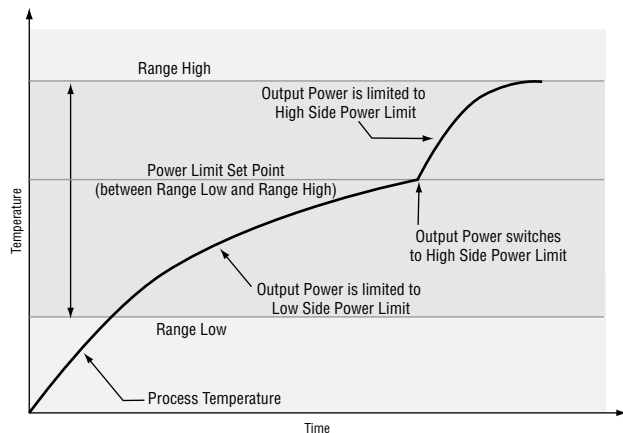

Figure 5.2b Power limits.

Input

Calibration Offset

Calibration offset allows a device to compensate for an inaccurate sensor, lead resistance or other factors that affect the input value. A positive offset increases the input value, and a negative offset decreases the input value.

The input 1 offset value can be viewed or changed with Calibration Offset 1 **[CAL 1]** (User Menu).

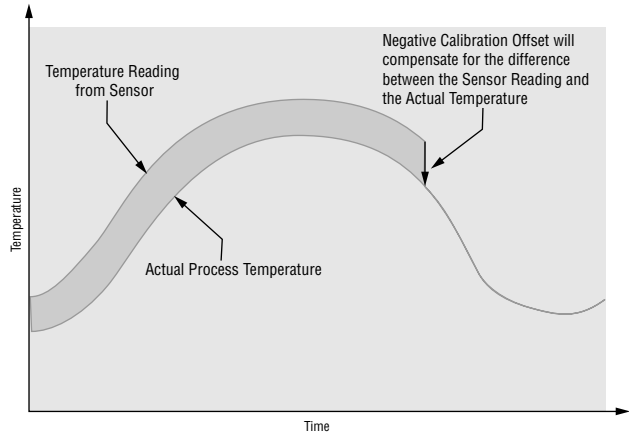

Figure 5.3a Calibration offset

Filter Time Constant

A time filter smooths an input signal by applying a first-order filter time constant to the signal. Either the displayed value or both the displayed and control values can be filtered. Filtering the displayed value makes it easier to monitor. Filtering the signal may improve the performance of PID control in a noisy or very dynamic system.

View or change the Input 1 time filter with Filter Time Constant 1 **[Ftr 1]** (Input 1 Menu). A positive value affects only the viewed values. A negative value affects both the viewed and control values.

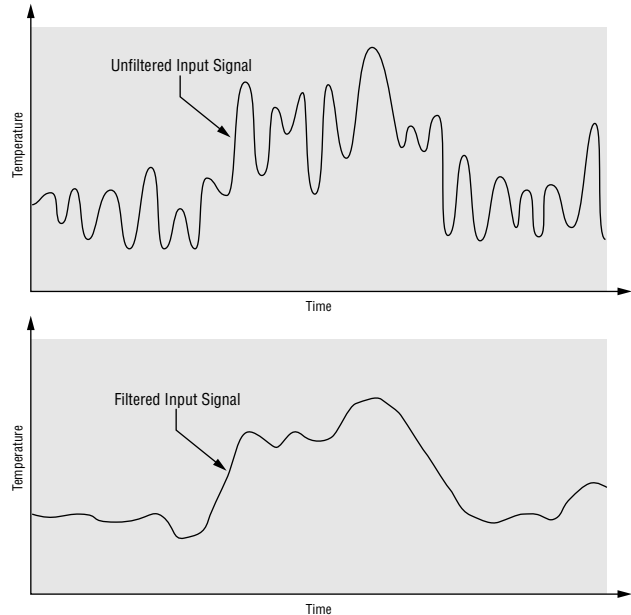

Figure 5.3b Filtered and unfiltered input signals.

Sensor Selection

You need to configure a controller to match the input device, which is normally a thermocouple, RTD or process transmitter. When you select an input device, the controller automatically sets the input linearization to match the sensor. It also sets high and low limits, which in turn limit the range-high and range-low values.

Use Sensor Type 1 **[Sen 1]** and Input 1 **[In 1]** (Input 1 Menu) to select the appropriate sensor for Input 1.

Range Low and Range High

The controller constrains the set point to a value between range high and range low. Range high cannot be set higher than the sensor high limit or lower than range low. Range low cannot be set lower than the sensor low limit or higher than range high.

Use Set Point 1 **[SP1]** (Home Page), Range Low 1 **[rL1]** and Range High 1 **[rH1]** (Input 1 Menu) to select or view values for the corresponding Input 1 parameters.

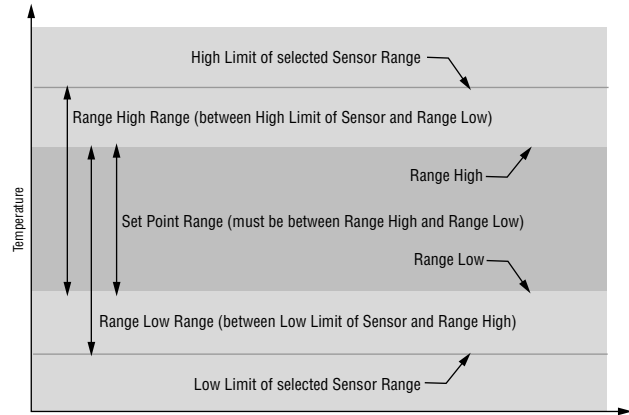

Figure 5.4a Sensor ranges.

Event Input

With an event input an operator can perform certain operations on a system by opening or closing a switch or applying a dc logic signal to the controller. This feature can add convenience, safety or security to a system.

Use Event Input Status **[ESE]** (Monitor Menu) to read the state of the event input parameter.

Use Event Function **[EFn]** (Input 2 Menu) to select how an event will affect the system.

- [nonE]** Events will not affect the system.
- [SP]** Switch to the event set point.
- [ROFF]** Turn off control outputs and disable alarms.
- [COFF]** Turn off control outputs.
- [LOC]** Lock out key board.
- [R-M]** Switch to manual mode.**
- [tuneE]** Initiate an auto-tune.
- [AL]** Clear an alarm.
- [SLOC]** Lock out everything except primary set point (auto or manual). If selected and if a profile is not running (non-ramping mode) will lock the user out of all parameters except set point and event outputs.
- [LJE]** Wait-for event input*
- [PAUS]** Pause*
- [F.L1]** Profile 1*
- [F.L2]** Profile 2*
- [hold]** Hold*
- [AbSP]** abort set point*

Use Event Condition **[ECn]** (Input 2 Menu) to select what condition will trigger an event.

- [Lo]** Low generates an event while the voltage is low (switch closed).
- [hi]** High generates an event while the voltage is high (switch open).
- [r,SE]** Rise changes the event state when the voltage changes from low to high.
- [FALL]** Fall changes the event state when the voltage changes from high to low.

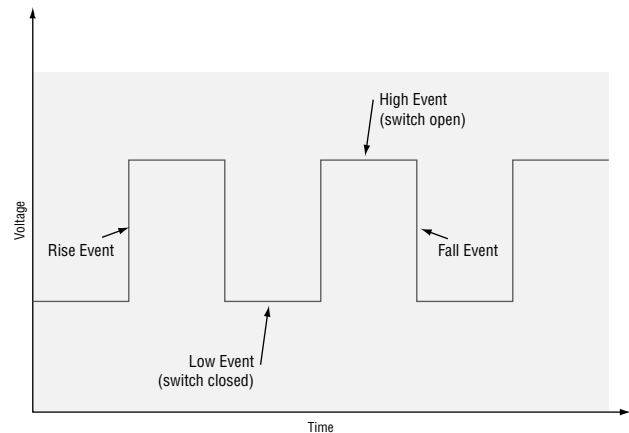

Figure 5.4b Event inputs.

*These parameters are added if the ramping software option has been ordered (96 __ - __ - AA __) .

**These parameters are removed if the ramping software option has been ordered (96 __ - __ - AA __) .

Retransmitting a Remote Set Point

The retransmit feature allows an output to retransmit an analog signal that can serve as an input variable for another device. The signal may serve as a remote set point for another controller or it could be used as input for a chart recorder to document system performance over time.

With the remote set point feature a set point can be received from another device or controller. This flexibility allows the output from one controller to control the set point of other controllers for chaining or multi-zone applications.

To use a remote set point a Series 96 must be equipped with Input 2 hardware (96_1 - _ _ _ _ - _ _ _ _).

Zone 1

To use the retransmit feature, a Series 96 must come equipped with a Universal Retransmit board installed in output 4 (96_ _ - _ _ _ M - _ _ _ _). Select the output scaling with Analog Output Range Low **[RLo]** and Analog Output Range High **[RH1]** (Output 4 Menu). Set an offset for the output range with Analog Output Offset **[RCAL]** (Output 4 Menu). For example: If you want to retransmit set point 50° to 250°F and set **[RLo]** to 50°, **[RH1]** to 250°.

Select the value that will be represented by Output 4 with Analog Output Selection **[Rout]** (Output 4 Menu).

- [OFF]** retransmit not active.
- [Proc]** retransmits the process value.
- [SP]** retransmits the set point.
- [Pcnt]** retransmits the percent power output.

Zones 2 and 3

To scale the remote set point input signal, set the set point value for the lowest Input 2 signal with **[rL2]** (Input 2 Menu) and the value for the highest Input 2 signal with **[rH2]** (Input 2 Menu). For example, if you want 4-20mA to represent a 50° to 250° set point, set **[rL2]** to 50 and **[rH2]** to 250. As the Input 2 signal varies between 4 and 20mA, the remote set point value will vary between 50° and 250°.

Use the Local-Remote parameter **[L-r]** (User Menu) to switch between the local **[L]** and remote **[r]** set point.

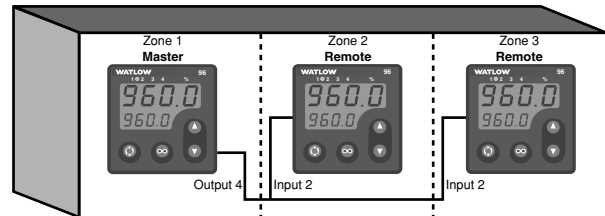

Figure 5.5a Retransmitting a remote set point.

Note: Remote set point input option is not available if the ramping option has been ordered (96XX-XXXX-AAXX).

Control Methods

On/Off Control

On/off control switches the output either full on or full off, depending on the input, set point and hysteresis values. The hysteresis value indicates the amount the process value must deviate from the set point to turn on output. Increasing the value decreases the number of times the output will cycle. Decreasing hysteresis improves controllability. With hysteresis set to 0 the process value would stay closer to the set point, but the output would switch on and off more frequently, causing “chattering.”

Set Proportional Band 1 **[Pb 1]** (PID 1 Menu) to 0 to set the controller to on/off control mode. Set the Output 1 hysteresis with Hysteresis 1 **[HYS 1]** (PID 1 Menu).

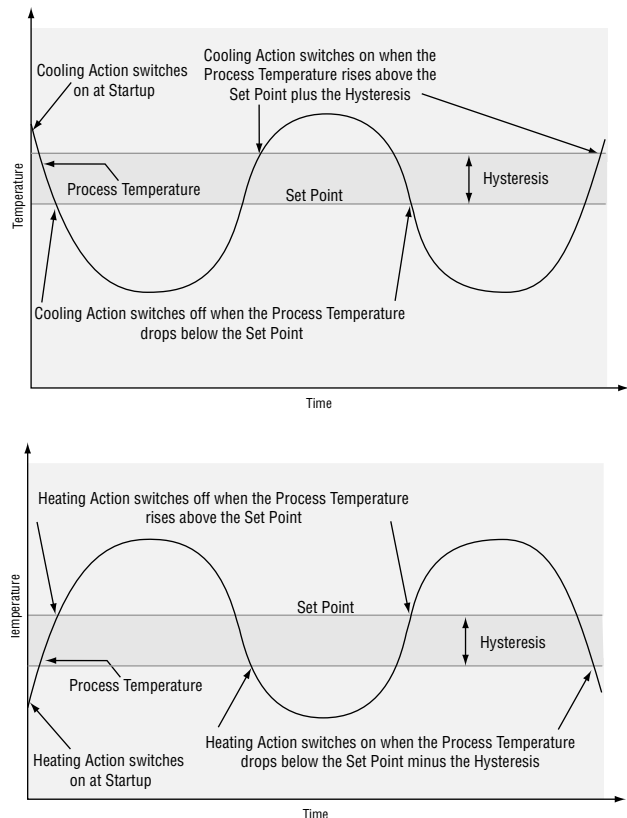

Figure 5.5b On/off control for cooling and heating.

Proportional Control

Some processes need to maintain a temperature or process value closer to the set point than an on/off control can provide. Proportional control provides closer control by adjusting the output when the temperature or process value is within a proportional band. When the value is in the band, the controller adjusts the output based on how close the process value is to the set point: the closer to set point the lower the output. This is similar to backing off on the gas pedal of a car as you approach a stop sign. It keeps the temperature or process value from swinging as widely as it would with a simple on/off control. However, when a system settles down, the temperature or process value tends to “droop” short of the set point.

With proportional control the output power level equals (set point minus process value) divided by propband.

The PID 1 proportional band can be viewed or changed with Propband 1 **Pb1** (PID 1 Menu).

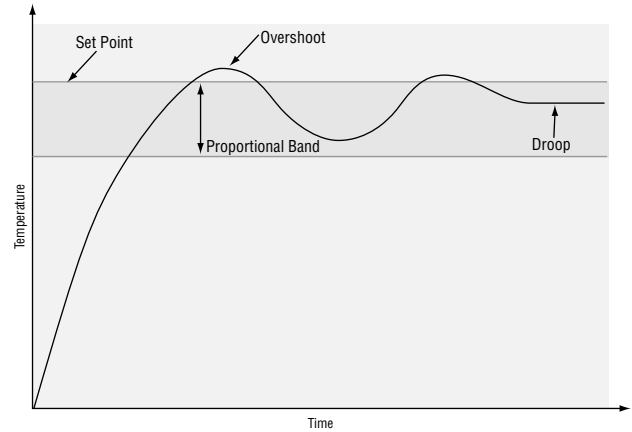

Figure 5.6a Proportional control.

Proportional plus Integral (PI) Control

The droop caused by proportional control can be corrected by adding integral (reset) control to the system. When the system has settled down the integral (reset) value is tuned to bring the temperature or process value closer to the set point. Integral (reset) determines the speed of the correction. However, this may increase the overshoot that occurs at start-up or when the set point is changed. Too much integral (reset) action will make the system unstable.

Integral (reset) is cleared when the process value is outside of the proportional band.

Reset is measured in repeats per minute. A low reset value causes a slow integrating action.

Integral is measured in minutes per repeat (the inverse of reset). A low integral value causes a fast integrating action.

View or change the Output 1 integral or reset value with Integral 1 **IE1** or Reset 1 **RE1** (PID 1 Menu). Integral appears if Units Type **UNIT** (Global Menu) is set to **SI**. Reset appears if **UNIT** is set to **US**.

Integral Value	Equivalent Reset Value
1 minute	1 repeat per minute
2 minutes	0.5 repeats per minute
3 minutes	0.33 repeats per minute
4 minutes	0.25 repeats per minute

Table 5.6 – Converting between integral and reset values.

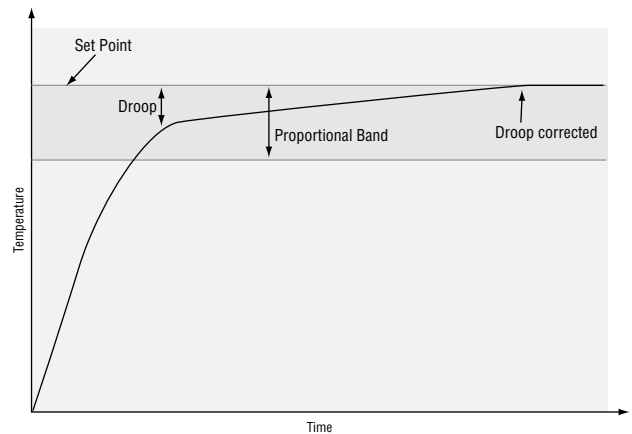

Figure 5.6b Proportional plus integral control.

Proportional plus Integral plus Derivative (PID) Control

Use derivative (rate) control to minimize the overshoot in a PI-controlled system. Derivative (rate) adjusts the output based on the rate of change in the temperature or process value. Too much derivative (rate) will make the system sluggish.

Rate action is active only when the process value is within twice the proportional value from the set point.

View or change the Output 1 derivative or rate with Derivative 1 or Rate 1 (PID 1 Menu). Derivative appears if Units Type (Global Menu) is set to . Rate appears if is set to .

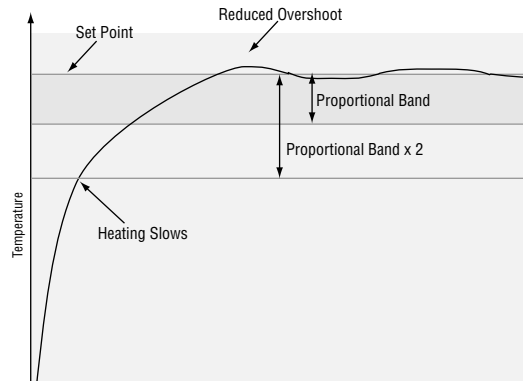

Figure 5.7a PID control.

Dual PID

In an application with one output assigned to heating and another assigned to cooling, each will have a separate set of PID parameters and separate dead bands. The heating parameters take effect when the process temperature is lower than the set point and the cooling parameters take effect when the process temperature is higher than the set point.

PID 1 parameters apply to Output 1; PID 2 parameters apply to Output 2. View or change PID 1 and PID 2 parameters in the PID 1 and PID 2 menus (Operations Page).

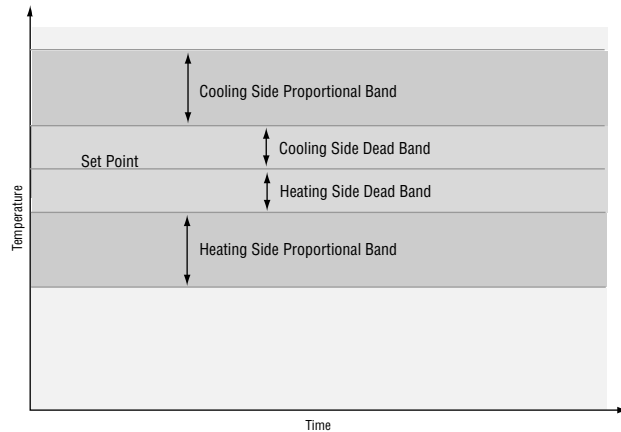

Figure 5.7b Dual PID.

Dead Band

In a dual PID application the dead bands above and below the set point can be used to save energy and wear on an application by maintaining a process temperature within an acceptable range. Shifting the effective cooling set point and heating set point keeps the two systems from fighting each other.

Proportional action ceases when the process value is within the dead band. Integral action continues to bring the process temperature to the set point. When the value of the dead band is zero, the heating element becomes active when the temperature drops below the set point, and the cooling element switches on when the temperature exceeds the set point.

The dead band for Output 1 can be viewed or changed with Dead Band 1 (PID 1 Menu). The dead band for Output 2 can be viewed or changed with Dead Band 2 (PID 2 Menu).

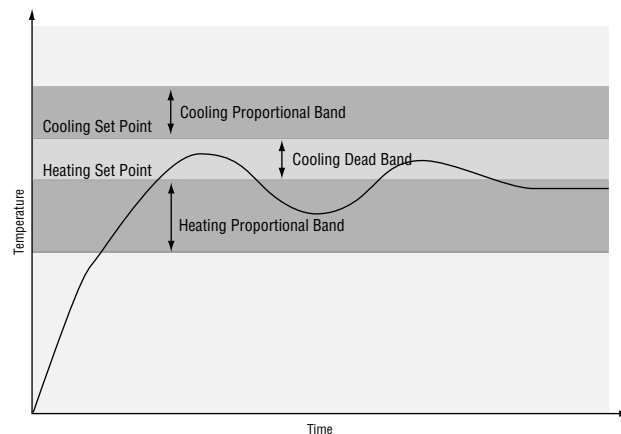

Figure 5.7c Cooling dead band.

Burst Fire

Burst firing provides even output power with the lowest level of noise generation (RFI). Burst fire is the preferred method for controlling a resistive load, providing a very short time base for longer heater life.

The controller determines when the ac sine wave will cross the 0-volts point, then switches the load on or off only at this point, minimizing RFI.

The burst fire feature for Output 1 can be turned on or off with Burst Fire 1 (**br51**) (PID 1 Menu). The burst fire feature for Output 1 requires either switched dc (96__-C ____-____) or solid-state relay (96__-K ____-____).

The burst fire feature for Output 2 can be turned on or off with Burst Fire 2 (**br52**) (PID 2 Menu). The burst fire feature for Output 2 requires either switched dc (96__-C ____-____) or solid-state relay (96__-K ____-____).

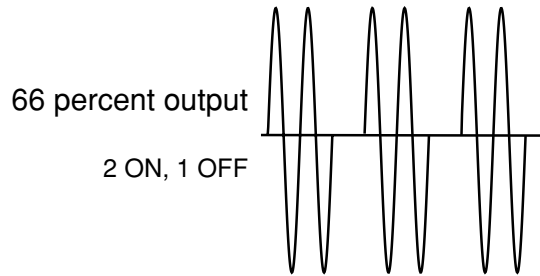
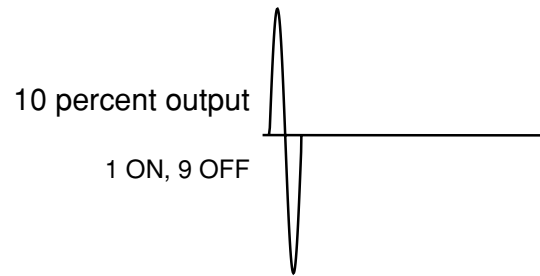
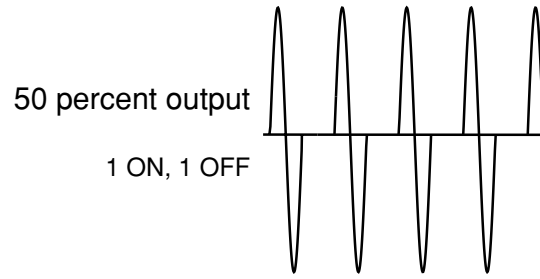
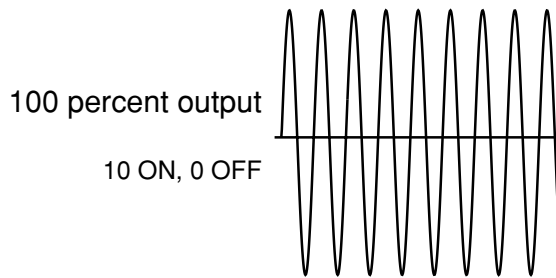

Figure 5.8a Burst fire.

Ramp to Set Point

Ramping protects materials and systems that cannot tolerate rapid temperature changes. The value of the ramp rate is the maximum degrees per minute or hour that the system temperature can change.

Select when ramping is active with Ramping Mode

RP (Global Menu).

OFF ramping not active.

SErE ramp at startup.

SEPE ramp at startup or when the set point changes.

Select whether the rate is in degrees per minute or hour with Ramp Scale (**RP S**) (Global Menu). Set the ramping rate with Ramp Rate (**RAEE**) (Global Menu).

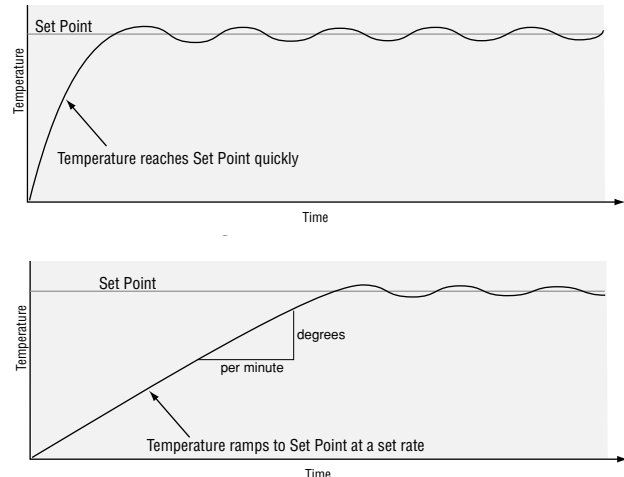

Figure 5.8b Ramping to set point.

Note: The Ramping Mode will not appear if the ramping software option has been ordered (96XX-XXXX-AAXX).

Alarms

An alarm takes some action, usually notifying an operator, when the process temperature leaves a defined range. A user can configure how and when an alarm is triggered and whether it turns off automatically when the alarm condition is over. The alarm examples below are for Output 2.

Alarm Set Points

The alarm high set point defines the temperature that will trigger a high side alarm. The alarm high set point must be higher than the alarm low set point and lower than the high limit of the sensor range.

The alarm low set point defines the temperature that will trigger a low side alarm. The alarm low set point must be lower than the alarm high set point and higher than the low limit of the sensor range.

Process or deviation alarm set points for Output 2 can be viewed or changed with Alarm 2 High **[A2h]** and Alarm 2 Low **[A2Lo]** (Alarm Menu).

Alarm Hysteresis

Modbus Register #720 r/w; values: (1-9999).

Alarm hysteresis is a zone inside each alarm set point. This zone is defined by adding the hysteresis value to the alarm low set point or subtracting the hysteresis value from the alarm high set point.

An alarm state is triggered when the process value reaches the alarm high or alarm low set point. Alarm hysteresis defines how far the process must return into the normal operating range before the alarm can be cleared.

The alarm hysteresis value for Output 2 can be viewed or changed with Hysteresis 2 **[HYS2]** (Output 2 Menu).

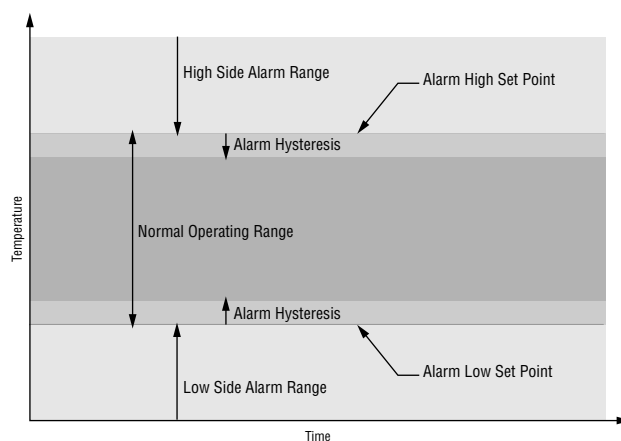

Figure 5.9a Alarm settings.

Process or Deviation Alarms

A process alarm uses one or two absolute set points to define an alarm condition.

A deviation alarm uses one or two set points that are defined relative to the control set point. High and low alarm set points are calculated by adding and/or subtracting offset values from the control set point. If the set point changes, the window defined by the alarm set points automatically change with it.

Alarm 2 Type **[A2Y2]** (Output 2 Menu) allows you to view or change whether the Output 2 alarm will function as a process or deviation alarm.

The alarm deviation value of Output 2 can be viewed or changed with Alarm 2 High **[A2h]** and Alarm 2 Low **[A2Lo]** (Alarm Menu).

Alarm Latching

Modbus Register #721 r/w; values: No (0), Yes (1).

A latched alarm will remain active after the alarm condition has passed. It can only be deactivated by the user. An alarm that is not latched will deactivate automatically when the alarm condition has passed.

Alarm 2 Latching **[A2L2]** (Output 2 Menu) allows you to view or change whether the Output 2 alarm will latch. A latched alarm condition that has been corrected can be reset by pressing the ∞ infinity key.

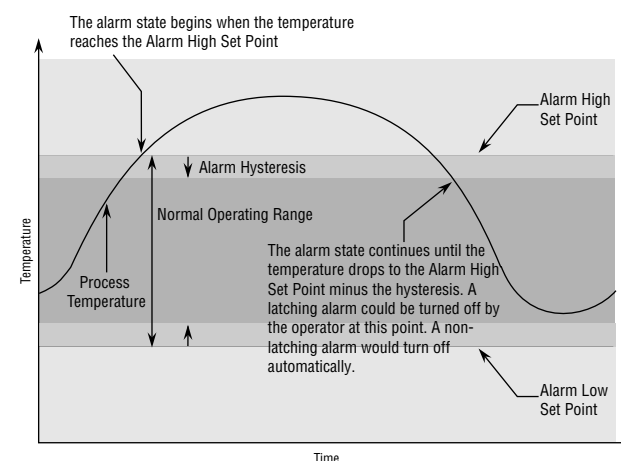

Figure 5.9b Alarm latching.

Alarm Silencing

Modbus Register #722 r/w; values: No (0), Yes (1).

Alarm silencing has two uses:

1. It is often used to allow a system to warm up after it has been started up. With alarm silencing on, an alarm is not triggered when the process temperature is initially lower than the alarm low set point. The process temperature has to enter the normal operating range beyond the hysteresis zone to activate the alarm function.

2. Alarm silencing also allows the operator to disable the alarm output while the controller is in an alarm state. The process temperature has to enter the normal operating range beyond the hysteresis zone to activate the alarm output function.

If a Series 96 output is functioning as a deviation alarm, the alarm is silenced when the set point is changed, until the process value re-enters the normal operating range. Alarm Silencing 2 **SIL2** (Output 2 Menu) allows you to view or change whether alarm silencing is on.

If Alarm Annunciation 2 **Ann2** (Output 2 Menu) is set to **YES**, the Output 2 indicator light will remain on and an alarm message will appear in the display, even though the alarm output is silenced.

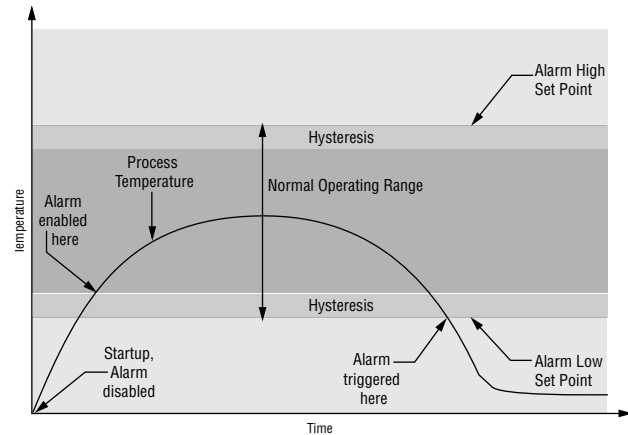

Figure 5.10 – Alarm silencing.

Errors

Open Loop Detect

Modbus Register #210 r; values: Clear (0), Error (1).

Open loop detect can alert the user of trouble on the input or output side of the control loop. It only works when the controller is operating with PID control. An open loop error is triggered when 100 percent power is applied at the control output for a period of time equal to the setting of integral (or the inverse of the reset value) without the input registering a 5° (°F or °C) change.

The open loop detect feature can be turned on or off with Open Loop Detect **OPLP** (Global Menu).

If an open loop error occurs, the controller outputs will shut off and **OPLP** will flash in the upper display of the controller. Shut down the system, check the input and control output wiring and check the input and output devices.

System Errors (error number in top display, error message in bottom display)

Modbus Register #209 r; (values in parenthesis below).

Refer to appendix, page A.2, in back of manual for troubleshooting tips about error codes.

Er 4 (4) Error 4 indicates there is a RAM malfunction.

Er 5 (5) Error 5 indicates nonvolatile memory checksum error.

Er 6 (6) Error 6 indicates a ROM malfunction.

Er 7 (7) Error 7 indicates a hardware failure.

Er 8 (8) Error 8 indicates a module error.

Er 9 (9) Error 9 indicates a configuration error.

Er 10 (10) Error 10 indicates a module has been changed.

Er 11 (11) Error 11 indicates new software has been installed.

Er 12 (12) Error 12 indicates that calibration data is corrupted.

Er 13 (13) Error 13 indicates an analog-to-digital timeout.

Er 14 (14) Error 14 indicates a serial EEPROM time-out.

Er 15 (15) Error 15 indicates a new unit.

Er 16 (16) Error 16 indicates an EEPROM invalid address.

Errors continued on next page.

Input Errors (error number in top display, percent output in bottom display)

Modbus Register #101 r; (values in parenthesis below).

Err1 (1) Error 1 indicates the input is too low to measure.

Err2 (2) Error 2 indicates the input is under the sensor range.

Err3 (3) Error 3 indicates the input is over the sensor range.

Err4 (4) Error 4 indicates the input is too large to measure.

No error = (0)

Bumpless Transfer

When the sensor opens (fails), the controller switches from automatic to manual operation. If bumpless transfer is active when the sensor fails, the control output (or outputs) will remain stable — a bumpless, or smooth, transition.

If the Failure Mode **FRIL** (Global Menu) is set to bumpless **bPLS** and the process has stabilized at a ± 5 percent output power level for 2 minutes prior to the sensor break, and that power level is less than 75 percent, the controller switches to manual operation at the last automatic power level. If these conditions are not met, the output goes to 0 percent power (output disabled).

If Failure Mode is set to manual **FRAN**, the Series 96 switches to manual operation at the percent power value of Manual Default Power **FRAN** (Global Menu). Manual operation provides open-loop control of the outputs from a range of -100 percent to 100 percent output. The Series 96 allows a

negative output value only when Output 1 or 2 is set to cool.

When the controller returns to closed-loop control, it uses the previous set point value.

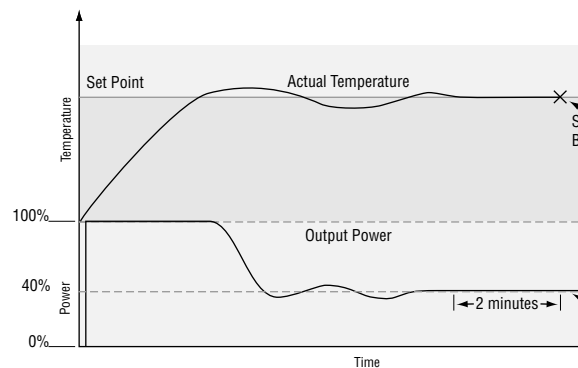

Figure 5.11 – Bumpless transfer.

Note: The bumpless transfer feature will not appear if the ramping software option has been ordered (96XX-XXXX-AAXX).

Communications

A Series 96 controller can also be programmed and monitored by connecting it with a personal computer or programmable logic controller (PLC) via serial communications. To use this communications option, a Series 96 must be equipped with a EIA/TIA 485 (96__ - __U - ____) or EIA/TIA 232 (96__ - __R - ____) communications board installed for Output 4.

Use of the EIA/TIA 485 requires that your PC or PLC use the EIA/TIA 485 interface in half duplex. Purchase an interface converter which communicates in half duplex when using a PC or PLC with an EIA/TIA 232 communications port. You must use the EIA/TIA 485 option to communicate with more than one control. This option directly supports up to 32 devices on a network.

To view or change controller settings with a personal computer, you need to run software that uses the Modbus RTU protocol to read or write to registers in

the controller. See Chapter Six for the Modbus registers. These registers contain the parameter values that determine how the controller will function and the values that reflect the current input and output values of the system.

Decimal points are not sent or received in Modbus. To determine decimal point locations, read the decimal parameter **DEC1**. For example, 127.5 degrees is read or written as 1275 degrees with the decimal parameter set to 0.0.

Parameters relating to communications appear in the Output 4 Menu (Setup Page). Match the Baud Rate **BAUD** to that of the computer and select an Address **ADDR** for the Series 96.

NOTE: For more information about communicating with Watlow controllers, go to www.watlow.com and download the Data Communications Reference: Electronic User's Manual. It is located under Literature, User's Manuals, English and search on *data communications reference*.

6

Chapter Six Parameters

Home Page

The resting-state display shows one of the following sets of data, depending on controller setup. The first prompt appears in the top display, the second in the bottom.

Display	Parameter	Range (Modbus Value)	Default	Modbus Register read/write	Conditions for Parameters to Appear
<input type="text" value="96"/> <input type="text" value="100"/>	Process 1 Set Point 1 Monitor the Process 1 value and change the Set Point values.	Range Low 1 to Range High 1 <input type="text" value="OFF"/> Off		100 r 300 r/w	Active: Always Active if the event set point is not active and Local or Remote Mode (User Menu) is set to <input type="text" value="L"/> (local) or Auto-Manual Operation Mode (User Menu) is set to <input type="text" value="Auto"/> (automatic). <input type="text" value="OFF"/> will appear when slewing below the <input type="text" value="rLi"/> value.
<input type="text" value="96"/> <input type="text" value="200"/>	Process 1 Remote Set Point** Monitor the Process 1 value and Remote Set Point values.	Range Low 1 to Range High 1		100 r 202 r	Active: Always Active if the remote set point is active and Local or Remote Mode <input type="text" value="L-r"/> (User Menu) is set to <input type="text" value="r"/> (remote) and Auto-Manual Operation Mode (User Menu) is set to <input type="text" value="Auto"/> (automatic).
<input type="text" value="96"/> <input type="text" value="500"/>	Process 1 Event Set Point** Monitor the Process 1 value and Event Set Point values.	Range Low 1 to Range High 1		100 r 202 r	Active: Always Active if Event Function <input type="text" value="EFn"/> (Input 2 Menu) is set to <input type="text" value="SP"/> (event set point), an event condition exists and Auto-Manual Operation Mode (User Menu) is set to <input type="text" value="Auto"/> (automatic).
<input type="text" value="96"/> <input type="text" value="500"/>	Process 1 Manual Set Point** Monitor the Process 1 value and change manual set point value.	Range Low 1 to Range High 1 heat modes: 0.0 to 100.0 cool modes: -100.0 to 0.0 heat/cool modes: -100.0 to 100.0		100 r 310 r/w	Active: Always Active if Auto-Manual Operation Mode (User Menu) is set to <input type="text" value="MAN"/> (manual), or if there is an error.

The parameters selected in the Custom Menu (Factory Page) will appear here.

*These parameters are added if the ramping software option has been ordered (96 __ - ____ - AA __) .

**These parameters are removed if the ramping software option has been ordered (96 __ - ____ - AA __) .

NOTE: Refer to Chapter 7 of this manual for information on parameters for creating ramp and soak profiles in Ramping versions of the Series 96.

NOTE: To see how all the pages, menus and parameters are grouped, refer to the inside back cover of this manual.

NOTE: For more information about how parameter settings affect the controller's operation, see Chapter Five, Features.

Operations Page

The Operations Page contains five menus:

Display	Parameter	Range (Modbus Value)	Default	Modbus Register read/write	Conditions for Parameters to Appear
OPER	Operations Page Select Go to an operations menu.	MON Monitor USER User PID1 PID 1 PID2 PID 2 (if output 2 is Active) ALM Alarm (if any alarms are active)			Active if Operations Page Mode Lock (Lockout Menu/Factory Page) is not set to HIDE .
MON OPER	Monitor Menu Operations Page	MON Monitor: comms value (0)			
PR2	Process 2** Monitor the process 2 value.			105 r	Active if Input 2 (Input 2 Menu) is not set to OFF or Ein and Operations Page Lock (Lockout Menu) is not set to HIDE .
Pcnt	Percent Output Monitor the control output power level.			103 r	Active if Operations Page Lock (Lockout Menu) is not set to HIDE .
rPSP	Ramping Set Point** Monitor the ramping set point.			203 r	Active if Ramping Mode (Global Menu) is not set to OFF and Operations Page Lock (Lockout Menu) is not set to HIDE .
ES	Event Input Status Monitor the event input status.	TRUE true (1)*** FALSE false (0)***		201 r	Active if EFn (Input 2 Menu) is not set to nonE and Operations Page Lock (Lockout Menu) is not set to HIDE .
USER OPER	User Menu Operations Page				
A-M	Auto-Manual** Operation Mode Select whether the controller is under auto or manual control.	AUTO Auto mode (0) MAN Manual mode (1)	AUTO (0)	301 r/w	Active if Operations Page Lock (Lockout Menu) is not set to HIDE .
AUT	Auto-tune Initiate or cancel an auto-tune.	OFF off or cancel an auto-tune in progress (0) UNE initiate an auto-tune (1) PID1 Set 1 only (2) PID2 Set 2 only (3)	OFF (0)	305 r/w	Active if Auto-Manual Operation Mode (User Menu) is set to AUTO (automatic) and Operations Page Lock (Lockout Menu) is not set to HIDE .

*These parameters are added if the ramping software option has been ordered (96 _ _ - _ _ _ - AA _ _) .

**These parameters are removed if the ramping software option has been ordered (96 _ _ - _ _ _ - AA _ _) .

***Numbers in parentheses are the ordinals/enumerators for use in Modbus communications.

Display	Parameter	Range (Modbus Value)	Default	Modbus Register read/write	Conditions for Parameters to Appear
RESP	Auto-tune Set Point Set the auto-tune set point as a percent of the currently active set point.	50 to 150	90	304 r/w	Active if Operations Page Lock (Lockout Menu) is not set to hide .
ESP	Event Set Point2** Set the set point when the event input is active as defined by Event Condition.	Range Low 1 to Range High 1	75°F, 24°C	306 r/w	Active if Input 2 (Input 2 Menu) is set to Ein (event input), EFn is set to SP , and Operations Page Lock (Lockout Menu) is not set to hide .
SP2	Set Point 2** Set the boost set point.	Range Low 1 to Range High 1	75°F, 24°C	319 r/w	Active if output 2 is present (not 96 __ _ A __ _ _ _ _), both Output 1 (Output 1 Menu) and Output 2 (Output 2 Menu) are set to either HEAT or COOL and Operations Page Lock (Lockout Menu) is not set to hide .
L-r	Local or Remote Mode** Set the mode to local or remote set point.	<input type="checkbox"/> L local (0) <input type="checkbox"/> r remote (1)	<input type="checkbox"/> L (0)	316 r/w	Active if Input 2 (Input 2 Menu) is not set to OFF , Input 2 is not set to Ein (event input) and Operations Page Lock (Lockout Menu) is not set to hide .
CAL1	Calibration Offset Set the input 1 calibration offset.	-1999 to 9999	0	605 r/w	Active if Operations Page (Lockout Menu) is not set to hide .
PID1	PID 1 Menu				
OPER	Operations Page				
Pb1	Propband 1 Set the proportional band for PID control.	0° to 9999° If Pb1 is set to 0 operates in on/off mode.	25°F, 14°C	500 r/w	Active if Operations Page Lock (Lockout Menu) is not set to hide .
It1	Integral 1 Set the integral time in minutes for output 1.	0.00 to 99.99 minutes per repeat	0.00 (0)	501 r/w	Active if Propband 1(PID 1 Menu) is not set to 0 , Units Type (Global Menu) is set to SI and Operations Page Lock (Lockout Menu) is not set to hide .
RE1	Reset 1 Set the reset time in repeats/minute for output 1.	0.00 to 99.99 repeats per minute	0.00 (0)	502 r/w	Active if Propband 1(PID 1 Menu) is not set to 0 , Units Type (Global Menu) is set to US and Operations Page Lock (Lockout Menu) is not set to hide .

NOTE: For more information about how parameter settings affect the controller's operation, see Chapter Five, Features.

Display	Parameter	Range (Modbus Value)	Default	Modbus Register read/write	Conditions for Parameters to Appear
hY52	Hysteresis 2 Sets the switching hysteresis for output 2.	1 to 9999	3°F, 2°C	517 r/w	Active if Output 2 is present, but output 2 is not a process type (not 96 _ _ _ A _ _ _ _ _ or 96 _ _ _ F _ _ _ _ _), or Output 2 (Output 2 Menu) is set to hEAT or COOL (opposite of Output 1 hEAT or COOL selection); and Propband 2 (PID 2 Menu) is set to 0 and Setup Page Lock (Lockout Menu) is not set to hIDE .
db 2	Dead Band 2 Set point shift for output 2 control.	0 to 9999	0 (0)	515 r/w	Active if output 2 is present (not 96 _ _ _ A _ _ _ _ _), one output is set to hEAT , another is set to COOL and Operations Page Lock (Lockout Menu) is not set to hIDE .
<hr/>					
ALM	Alarm Menu				
OPER	Operations Page				
ALLo	Alarm 2 Low Set the low alarm set point for output 2.	Process: low limit of selected sensor range to Alarm 2 High-1 Deviation: -1999 to 0	Process: low limit of selected sensor range Deviation: -999	321 r/w	Active if Output 2 (Output 2 Menu) is set to AL (Alarm), Alarm Active Sides 2 (Output 2 Menu) is not set to hi , output 2 is present, but is not a process output (not 96 _ _ _ A _ _ _ _ _ or 96 _ _ _ F _ _ _ _ _) and Operations Page Lock (Lockout Menu) is not set to hIDE .
ALHi	Alarm 2 High Set the high alarm set point for output 2.	Process: Alarm 2 Low+1 to high limit of selected sensor range Deviation: 0 to 9999	Process: high limit of selected sensor range Deviation: 999	322 r/w	Active if Output 2 (Output 2 Menu) is set to AL (Alarm), Alarm Active Sides 2 (Output 2 Menu) is not set to Lo , output 2 is present, but is not a process (not 96 _ _ _ A _ _ _ _ _ or 96 _ _ _ F _ _ _ _ _) and Operations Page Lock (Lockout Menu) is not set to hIDE .
ALLo	Alarm 3 Low Set the low alarm set point for output 3.	Process: low limit of selected sensor range to Alarm 3 High-1 Deviation: -1999 to 0	Process: low limit of selected sensor range Deviation: -999	340 r/w	Active if Output 3 (Output 3 Menu) is AL (Alarm), Alarm Sides 3 (Output 3 Menu) is not hi , output 3 is present (96 _ _ _ D _ _ _ _ _) and Operations Page Lock (Lockout Menu) is not set to hIDE .

NOTE: For more information about how parameter settings affect the controller's operation, see Chapter Five, Features.

Display	Parameter	Range (Modbus Value)	Default	Modbus Register read/write	Conditions for Parameters to Appear
R3h	Alarm 3 High Set the high alarm set point for output 3.	Process: Alarm 3 Low+1 to high limit of selected sensor range Deviation: 0 to 9999	Process: high limit of selected sensor range Deviation: 999	341 r/w	Active if Output 3 (Output 3 Menu) is set to RL (Alarm), Alarm Sides 3 (Output 3 Menu) is set to Lo , output 3 is present (96 ___ D ___) and Operations Page Lock (Lockout Menu) is not set to hide .
R4Lo	Alarm 4 Low Set the low alarm set point for output 4.	Process: low limit of selected sensor range to Alarm 4 High-1 Deviation: -1999 to 0	Process: low limit of selected sensor range Deviation: -999	none****	Active if Output 4 (Output Menu 4) is set to RL (Alarm), Alarm Sides 4 (Output Menu 4) is not hi , output 4 is a relay (96 ___ D ___) and Operations Page Lock (Lockout Menu) is not set to hide .
R4h	Alarm 4 High Set the high alarm set point for output 4.	Process: Alarm 4 Low+1 to high limit of selected sensor range Deviation: 0 to 9999	Process: high limit of selected sensor range Deviation: 999	none****	Active if Output 4 (Output Menu 4) is set to RL (Alarm), Alarm Sides 4 (Output Menu 4) is not set to Lo , output 4 is a relay (96 ___ D ___) and Operations Page Lock (Lockout Menu) is not set to hide .

****Output 4 parameters cannot be changed with the Modbus interface.

NOTE: For more information about how parameter settings affect the controller's operation, see Chapter Five, Features.

Setup Page

The setup page contains seven menus.

Display	Parameter	Range (Modbus Value)	Default	Modbus Register read/write	Conditions for Parameters to Appear
<input type="checkbox"/> SEt	Setup Page Go to a setup menu.	<input type="checkbox"/> inP1 Input 1 <input type="checkbox"/> inP2 Input 2 <input type="checkbox"/> Out1 Output 1 (if present) <input type="checkbox"/> Out2 Output 2 (if present) <input type="checkbox"/> Out3 Output 3 (if present) <input type="checkbox"/> Out4 Output 4 (if present) <input type="checkbox"/> GLbL Global	<input type="checkbox"/> inP1		Active if Setup Page Lock (Lock-out Menu) is not set to <input type="checkbox"/> hidE .
<input type="checkbox"/> inP1	Input 1 Menu				
<input type="checkbox"/> SEt	Setup Page				
<input type="checkbox"/> SEn1	Sensor Type 1 Sets the input hardware type of input 1.	<input type="checkbox"/> tC Thermocouple (0) <input type="checkbox"/> rtd RTD (1)*** <input type="checkbox"/> Proc Process (2)	<input type="checkbox"/> tC (0)***	600 r/w	Active if Setup Page Lock (Lock-out Menu) is not set to <input type="checkbox"/> hidE .
<input type="checkbox"/> in1	Input 1 Sets the input linearization parameter of input.	If Sensor Type is set to thermocouple: <input type="checkbox"/> J J (0) <input type="checkbox"/> K K (1) <input type="checkbox"/> T T (2) <input type="checkbox"/> E E (3) <input type="checkbox"/> N N (4) <input type="checkbox"/> C C (5) <input type="checkbox"/> D D (6) <input type="checkbox"/> PT2 PT2 (7) <input type="checkbox"/> R R (8) <input type="checkbox"/> S S (9) <input type="checkbox"/> B B (10) If Sensor Type is set to RTD: <input type="checkbox"/> din RTD_DIN (11) <input type="checkbox"/> JIS RTD_JIS (12) If Sensor Type is set to process: <input type="checkbox"/> 4-20 4-20mA (13) <input type="checkbox"/> 0-20 0-20mA (14) <input type="checkbox"/> 0-5 0-5V _{rms} (dc) (15) <input type="checkbox"/> 1-5 1-5V _{rms} (dc) (16) <input type="checkbox"/> 0-10 0-10V _{rms} (dc) (17)	If Sensor Type (Input 1 Menu) is changed to thermocouple: <input type="checkbox"/> J (0) If Sensor Type is changed to RTD: <input type="checkbox"/> din (11) If Sensor Type is set to process: <input type="checkbox"/> 4-20 (13)	601 r/w	Active if Setup Page Lock (Lock-out Menu) is not set to <input type="checkbox"/> hidE .

*These parameters are added if the ramping software option has been ordered (96 __ - ____ - AA __) .

**These parameters are removed if the ramping software option has been ordered (96 __ - ____ - AA __) .

***Numbers in parentheses are the ordinals/enumerators for use in Modbus communications.

NOTE: For more information about how parameter settings affect the controller's operation, see Chapter Five, Features.

Display	Parameter	Range (Modbus Value)	Default	Modbus Register read/write	Conditions for Parameters to Appear
rl 1	Range Low 1 Set the input range low. This setting is the lowest value that the set point can have.	See Specifications in the Appendix for sensor ranges and defaults.	See Specifications in the Appendix for sensor ranges and defaults.	602 r/w	Active if Setup Page Lock (Lockout Menu) is not set to hide .
rh 1	Range High 1 Set the input range high. This setting is the highest value that the set point can have.	See Specifications in the Appendix for sensor ranges and defaults.	See Specifications in the Appendix for sensor ranges and defaults.	603 r/w	Active if Setup Page Lock (Lockout Menu) is not set to hide .
dec 1	Decimal 1 Sets the position of the decimal point for input readings.	If Set Sensor Type is RTD or thermocouple (excluding R, S or B thermocouple): 0 0 (0) 00 0.0 (1) If Set Sensor Type is a process: 0 0 (0) 00 0.0 (1) 000 0.00 (2) 0000 0.000 (3)	0	606 r/w	Active if Setup Page Lock (Lockout Menu) is not set to hide .
fer 1	Input Software Filter 1 Set the filter time for the input, in seconds. This smooths out a rapidly changing input signal. Positive values affect the monitor readings only. Negative values affect both the monitor readings and the control values.	-60.0 to 60.0 (-600 to 600)	0 (0) [1.0 (10) if dec 1 is set to 0.0].	604 r/w	Active if Setup Page Lock (Lockout Menu) is not set to hide .
inp2 SEE	Input 2 Menu Setup Page				
in 2	Input 2 Sets the input type parameter of input 2.	OFF off: (0) E in event input: (1) 4-20 4-20mA (2)** 0-20 0-20mA (3)** 0-5 0-5V _{rms} (dc) (4)** 1-5 1-5V _{rms} (dc)(5)** 0-10 0-10V _{rms} (dc) (6)**	OFF (0)	611 r/w	Active if input 2 hardware is present (96_1_ _ _ _ _ _ _ _ _ _) and Setup Page Lock (Lockout Menu) is not set to hide .

NOTE: For more information about how parameter settings affect the controller's operation, see Chapter Five, Features.

Display	Parameter	Range (Modbus Value)	Default	Modbus Register read/write	Conditions for Parameters to Appear
rl 2	Range Low 2** Set the input range low. This setting is the value Pr 2 will read when Input 2 is at its low range.	-1999 to rh 2 Range High 2	rL1	612 r/w	Active if input 2 hardware is present (96_1_ _ _ _ _ _ _ _ _ _) and In 2 is not set to Ein or OFF and Setup Page Lock (Lockout Menu) is not set to hide .
rh 2	Range High 2** Set the input range high. This setting is the value Pr 2 will read when Input 2 is at its high range.	rl 2 Range Low 2 to 9999	rh1	613 r/w	Active if input 2 hardware is present (96_1_ _ _ _ _ _ _ _ _ _), and In 2 is not set to Ein or OFF and Setup Page Lock (Lockout Menu) is not set to hide .
CAL 2	Calibration Offset 2** Set the input calibration offset. This allows you to compensate for lead resistance, sensor errors and other factors.	-1999 to 9999	0	615 r/w	Active if input 2 hardware is present (96_1_ _ _ _ _ _ _ _ _ _), and In 2 is not set to Ein or OFF and Setup Page Lock (Lockout Menu) is not set to hide .
Fn	Event Function Select the event function.	none no function (0) SP switch to event set point (1)** ROFF turn off control outputs and disable alarms (2) COFF turn off control outputs (3) LOC lock out keyboard (4) A-P switch to manual mode (5)** tune initiate an auto-tune (6) AL clear alarm (7) SLOC lock out everything except primary set point (auto or manual). If selected and if a profile is not running (non-ramping mode) will lock the user out of all parameters except set point and event outputs. (8) LJE wait-for event input (9)* PAUS pause (10)* FIL1 profile 1 (11) * FIL2 profile 2 (12) * hold hold (13)* AbSP abort set point (14)*	none (0)	1060 r/w	Active if input 2 hardware is present (96_1_ _ _ _ _ _ _ _ _ _) and Input 2 (Input 2 Menu) is set to Ein (Event Input) and Setup Page Lock (Lockout Menu) is not set to hide . * LJE , PAUS , FIL1 , FIL2 , hold , and AbSP are added if ramping version of the controller is selected (96_ _ _ _ -AA_ _). ** SP and A-P are removed if ramping version of the controller is selected (96_ _ _ _ -AA_ _).

*These parameters are added if the ramping software option has been ordered (96_ _ _ _ - AA_ _) .

**These parameters are removed if the ramping software option has been ordered (96_ _ _ _ - AA_ _) .

NOTE: For more information about how parameter settings affect the controller's operation, see Chapter Five, Features.

Display	Parameter	Range (Modbus Value)	Default	Modbus Register read/write	Conditions for Parameters to Appear
ECN	Event Condition Select the condition to trigger an event.	LO low (0); H high (1) RISE rise (2) FALL fall (3)	LO (0)	1061 r/w	Active if input 2 hardware is present (96_1_ _ _ _ _ _ _ _ _), Input 2 (Input 2 Menu) is set to Ein (Event Input), Event Function (Input 2 Menu) is not set to nonE and Setup Page Lock (Lockout Menu) is not set to hidE .
AbSP	Abort Set Point	OFF , Range Low 1 to Range High 1 (-32768)	75°F, 24°C	1211 r/w	Active if EFn is set to AbSP .
Out 1 SEt	Output 1 Menu**** Setup Page				
Out 1	Output 1 Select whether the control output will control for heating or cooling.	HEAT heat (0) COOL cool (1)	HEAT (0)	700 r/w	Active if Setup Page Lock (Lockout Menu) is not set to hidE .
Proc 1	Process 1 Type Sets process 1 output type.	4-20 4-20mA (0) 0-20 0-20mA (1) 0-5 0-5V _{rms} (dc) (2) 1-5 1-5V _{rms} (dc) (3) 0-10 0-10V _{rms} (dc) (4)	4-20 (0)	701 r/w	Active if output 1 is equipped for a process (96_ _ _ F_ _ _ _ _ _ _ _ _) and Setup Page Lock (Lockout Menu) is not set to hidE .
Out 2 SEt	Output 2 Menu**** Setup Page				
Out 2	Output 2 Select output 2 function.	OFF off (0) HEAT heat (1) COOL cool (2) AL alarm (3) Event event (4)*	OFF (0)	717 r/w	Active if output 2 is present (not 96_ _ _ A_ _ _ _ _ _ _ _ _) and Setup Page Lock (Lockout Menu) is not set to hidE . *Event output is added if ramping version of the controller is selected (96_ _ _ _ _ AA_ _ _).
Proc 2	Process 2 Type Sets output 2 process type.	4-20 4-20mA (0) 0-20 0-20mA (1) 0-5 0-5V _{rms} (dc) (2) 1-5 1-5V _{rms} (dc) (3) 0-10 0-10V _{rms} (dc) (4)	4-20 (0)	718 r/w	Active if output 2 is equipped for a process (96_ _ _ F_ _ _ _ _ _ _ _ _) and Setup Page Lock (Lockout Menu) is not set to hidE .
ALY2	Alarm 2 Type Select alarm type. A process alarm responds when the temperature leaves a fixed range. A deviation alarm responds when the temperature deviates from the set point by a set number of degrees.	Proc process alarm (0) dE deviation alarm (1)	Proc (0)	719 r/w	Active if output 2 is present, but is not process type (not 96_ _ _ A_ _ _ _ _ _ _ _ _ or 96_ _ _ F_ _ _ _ _ _ _ _ _), Output 2 (Output 2 Menu) is set to AL (Alarm) and Setup Page Lock (Lockout Menu) is not set to hidE .

****Output 1 and Output 2 menu prompts cannot have range selections set to identical control modes, e.g. Heat/Heat or Cool/Cool if the ramping software option has been ordered (96_ _ _ _ _ AA_ _ _).

NOTE: For more information about how parameter settings affect the controller's operation, see Chapter Five, Features.

Display	Parameter	Range (Modbus Value)	Default	Modbus Register read/write	Conditions for Parameters to Appear
ALH2	Alarm Hysteresis 2 Sets the switching hysteresis for the alarm output. This defines a band on the inside of the alarm set point. When the process temperature is in this band, the alarm state will not change.	1 to 9999	3°F, 2°C	720 r/w	Active if output 2 is present, but is not process type (not 96 _ _ _ _ A _ _ _ _ _ or 96 _ _ _ _ F _ _ _ _ _), Output 2 (Output 2 Menu) is set to <input type="checkbox"/> AL (Alarm) and Setup Page Lock (Lockout Menu) is not set to <input type="checkbox"/> h i d E .
LAL2	Latching 2 Enable Alarm 2 Latching.	<input type="checkbox"/> no no action (0) <input type="checkbox"/> YES latching enabled (1)	<input type="checkbox"/> no (0)	721 r/w	Active if output 2 is present, but is not a process type (not 96 _ _ _ _ A _ _ _ _ _ or 96 _ _ _ _ F _ _ _ _ _), Output 2 (Output 2 Menu) is set to <input type="checkbox"/> AL (Alarm) and Setup Page Lock (Lockout Menu) is not set to <input type="checkbox"/> h i d E .
SIL2	Silencing 2 Enable Silence 2.	<input type="checkbox"/> no no action (0) <input type="checkbox"/> YES silence alarm (1)	<input type="checkbox"/> no (0)	722 r/w	Active if output 2 is present, but is not a process type (not 96 _ _ _ _ A _ _ _ _ _ or 96 _ _ _ _ F _ _ _ _ _), Output 2 (Output 2 Menu) is set to <input type="checkbox"/> AL (Alarm) and Setup Page Lock (Lockout Menu) is not set to <input type="checkbox"/> h i d E .
S i d 2	Alarm Active Sides 2 Select which side or sides the alarm set points can be programmed for.	<input type="checkbox"/> both both (0) <input type="checkbox"/> h i high (1): high side only <input type="checkbox"/> l o low (2): low side only	<input type="checkbox"/> both (0)	723 r/w	Active if output 2 is present, but is not a process type (not 96 _ _ _ _ A _ _ _ _ _ or 96 _ _ _ _ F _ _ _ _ _), Output 2 (Output 2 Menu) is set to <input type="checkbox"/> AL (Alarm) and Setup Page Lock (Lockout Menu) is not set to <input type="checkbox"/> h i d E .
LAL2	Alarm Logic 2 Select alarm 2 output condition in the alarm state.	<input type="checkbox"/> AL D alarm condition de-energizes output (fail-safe operation) (0) <input type="checkbox"/> AL C alarm condition energizes output (1)	<input type="checkbox"/> AL D (0)	724 r/w	Active if output 2 is present, but is not a process type (not 96 _ _ _ _ A _ _ _ _ _ or 96 _ _ _ _ F _ _ _ _ _), Output 2 (Output 2 Menu) is set to <input type="checkbox"/> AL (Alarm) and Setup Page Lock (Lockout Menu) is not set to <input type="checkbox"/> h i d E .
ANNU2	Alarm Annunciation 2 Select alarm 2 annunciation option.	<input type="checkbox"/> no no (0) <input type="checkbox"/> YES yes (1)	<input type="checkbox"/> YES (1)	725 r/w	Active if output 2 is present, but is not a process type (not 96 _ _ _ _ A _ _ _ _ _ or 96 _ _ _ _ F _ _ _ _ _), Output 2 (Output 2 Menu) is set to <input type="checkbox"/> AL (Alarm) and Setup Page Lock (Lockout Menu) is not set to <input type="checkbox"/> h i d E .

NOTE: For more information about how parameter settings affect the controller's operation, see Chapter Five, Features.

Display	Parameter	Range (Modbus Value)	Default	Modbus Register read/write	Conditions for Parameters to Appear
OUT3 SET	Output 3 Menu Setup Page				
OE 3	Output 3 Select type of output 3.	OFF off (0) AL alarm (1) Event event (2)*	OFF (0)	734 r/w	Active if output 3 present (96 _ _ - _ _ D _ - _ _ _), Output 3 (Output 3 Menu) is set to AL (Alarm) and Setup Page Lock (Lockout Menu) is not set to hide . *Event output is added if ramping version of the controller is selected (96 _ - _ - - AA _ .)
ALY3	Alarm 3 Type Select alarm 3 type.	Proc process alarm (0) DE deviation alarm (1)	Proc (0)	736 r/w	Active if output 3 present (96 _ _ - _ _ D _ - _ _ _), Output 3 (Output 3 Menu) is set to AL (Alarm) and Setup Page Lock (Lockout Menu) is not set to hide .
AHY3	Alarm Hysteresis 3 Set the switching hysteresis for the alarm output. This defines a band on the inside of the alarm set point. When the process temperature is in this band, the alarm state will not change.	1 to 9999	3°F, 2°C	737 r/w	Active if output 3 is present (96 _ _ - _ _ D _ - _ _ _), Output 3 (Output 3 Menu) is set to AL (Alarm) and Setup Page Lock (Lockout Menu) is not set to hide .
LRE3	Latching 3 Enable Alarm 3 Latching.	no no action (0) YES latching enabled (1)	no (0)	738 r/w	Active if output 3 is present (96 _ _ - _ _ D _ - _ _ _), Output 3 (Output 3 Menu) is set to AL (Alarm) and Setup Page Lock (Lockout Menu) is not set to hide .
SIL3	Silencing 3 Enable Silence 3.	no no action (0) YES silence 3 enabled (1)	no (0)	739 r/w	Active if output 3 is present (96 _ _ - _ _ D _ - _ _ _), Output 3 (Output 3 Menu) is set to AL (Alarm) and Setup Page Lock (Lockout Menu) is not set to hide .
SID3	Alarm Active Sides 3 Select alarm 3 side option.	both both (0) hi high (1) lo low (2)	both (0)	740 r/w	Active if output 3 is present (96 _ _ - _ _ D _ - _ _ _), Output 3 (Output 3 Menu) is set to AL (Alarm) and Setup Page Lock (Lockout Menu) is not set to hide .

NOTE: For more information about how parameter settings affect the controller's operation, see Chapter Five, Features.

Display	Parameter	Range (Modbus Value)	Default	Modbus Register read/write	Conditions for Parameters to Appear
L9C3	Alarm Logic 3 Select alarm 3 output condition in the alarm state.	RL 0 alarm condition de-energizes output (fail-safe operation) (0) RL 1 alarm condition energizes output (1)	RL 0 (0)	741 r/w	Active if output 3 is present (96 _ _ _ D _ _ _ _), Output 3 (Output 3 Menu) is set to RL (Alarm) and Setup Page Lock (Lockout Menu) is not set to hIDE .
Ann3	Alarm Annunciation 3 Select alarm 3 annunciation option.	no no (0) YES yes (1)	YES (1)	742 r/w	Active if output 3 is present (96 _ _ _ D _ _ _ _), Output 3 (Output 3 Menu) is set to RL (Alarm) and Setup Page Lock (Lockout Menu) is not set to hIDE .
Out4 SEt	Output 4 Menu Setup Page				
OE 4	Output 4 Select output 4 type.	OFF off RL alarm Event event*	OFF	none****	Active if output 4 is equipped for a relay (96 _ _ _ _ D _ _ _ _) and Setup Page Lock (Lockout Menu) is not set to hIDE . *Event output is added if ramping version of the controller is selected (96 _ _ _ -AA _ .)
AL44	Alarm 4 Type Select alarm 4 type.	Proc process alarm dE deviation alarm	Proc	none****	Active if output 4 is equipped for a relay (96 _ _ _ _ D _ _ _ _), Output 4 (Output 4 Menu) is set to RL (Alarm) and Setup Page Lock (Lockout Menu) is not set to hIDE .
AH44	Alarm Hysteresis 4 Sets the switching hysteresis for the alarm output. This defines a band on the inside of the alarm set point. When the process temperature is in this band, the alarm state will not change.	1 to 9999	3°F, 2°C	none****	Active if output 4 is equipped for a relay (96 _ _ _ _ D _ _ _ _), Output 4 (Output 4 Menu) is set to RL (Alarm) and Setup Page Lock (Lockout Menu) is not set to hIDE .
LRE4	Latching 4 Enable alarm 4 latching.	no no action YES latching enabled	no	none****	Active if output 4 is equipped for a relay (96 _ _ _ _ D _ _ _ _), Output 4 (Output 4 Menu) is set to RL (Alarm) and Setup Page Lock (Lockout Menu) is not set to hIDE .

****Output 4 parameters cannot be changed with the Modbus interface.

NOTE: For more information about how parameter settings affect the controller's operation, see Chapter Five, Features.

Display	Parameter	Range (Modbus Value)	Default	Modbus Register read/write	Conditions for Parameters to Appear
SIL4	Silencing 4 Enable Silence 4.	<input type="checkbox"/> no no action <input type="checkbox"/> YES silence 4 enabled	<input type="checkbox"/> no	none****	Active if output 4 is equipped for a relay (96 _ _ _ _ D _ _ _ _), Output 4 (Output 4 Menu) is set to <input type="checkbox"/> AL (Alarm) and Setup Page Lock (Lockout Menu) is not set to <input type="checkbox"/> h i d E .
Sid4	Alarm Active Sides 4 Select alarm 4 side option.	<input type="checkbox"/> both both <input type="checkbox"/> h i high <input type="checkbox"/> Lo low	<input type="checkbox"/> both	none****	Active if output 4 is equipped for a relay (96 _ _ _ _ D _ _ _ _), Output 4 (Output 4 Menu) is set to <input type="checkbox"/> AL (Alarm) and Setup Page Lock (Lockout Menu) is not set to <input type="checkbox"/> h i d E .
L9c4	Alarm Logic 4 Select alarm 4 output condition in alarm state.	<input type="checkbox"/> AL 0 alarm condition de-energizes output <input type="checkbox"/> AL 1 alarm condition energizes output	<input type="checkbox"/> AL 0	none****	Active if output 4 is equipped for a relay (96 _ _ _ _ D _ _ _ _), Output 4 (Output 4 Menu) is set to <input type="checkbox"/> AL (Alarm) and Setup Page Lock (Lockout Menu) is not set to <input type="checkbox"/> h i d E .
Rnu4	Alarm Annunciation 4 Select alarm 4 annunciation option.	<input type="checkbox"/> no no <input type="checkbox"/> YES yes	<input type="checkbox"/> YES	none****	Active if output 4 is equipped for a relay (96 _ _ _ _ D _ _ _ _), Output 4 is Set to <input type="checkbox"/> AL (Alarm) and Setup Page Lock (Lockout Menu) is not set to <input type="checkbox"/> h i d E .
Rout	Analog Output 4 Select Output 4 retransmit signal.	<input type="checkbox"/> OFF not active <input type="checkbox"/> Proc process <input type="checkbox"/> SP set point <input type="checkbox"/> Pcnt percent power	<input type="checkbox"/> OFF	none****	Active if output 4 is equipped for retransmit (96 _ _ _ _ M _ _ _ _) and Setup Page Lock (Lockout Menu) is not set to <input type="checkbox"/> h i d E .
Prc4	Process 4 Type Set process 4 output type.	<input type="checkbox"/> 4-20 4-20 mA <input type="checkbox"/> 0-20 0-20 mA <input type="checkbox"/> 0-5 0-5V ^{dc} <input type="checkbox"/> 1-5 1-5V ^{dc} <input type="checkbox"/> 0-10 0-10V ^{dc}	<input type="checkbox"/> 4-20	none****	Active if output 4 is equipped for retransmit (96 _ _ _ _ M _ _ _ _) and <input type="checkbox"/> Rout (Analog Output 4) is not set to <input type="checkbox"/> OFF and Setup Page Lock (Lockout Menu) is not set to <input type="checkbox"/> h i d E .
RLo	Analog Output Low Set analog output range low scaling.	-1999 to <input type="checkbox"/> R h i Analog Output High	Sensor type rL1	none****	Active if output 4 is equipped for retransmit (96 _ _ _ _ M _ _ _ _), Analog Output 4 (Output 4 Menu) is set to <input type="checkbox"/> OFF and Setup Page Lock (Lockout Menu) is not set to <input type="checkbox"/> h i d E .
Rhi	Analog Output High Set analog output range high scaling.	<input type="checkbox"/> R Lo Analog Output Low to 9999	Sensor type rh1	none****	Active if output 4 is equipped for retransmit (96 _ _ _ _ M _ _ _ _), Analog Output 4 (Output 4 Menu) is set to <input type="checkbox"/> OFF and Setup Page Lock (Lockout Menu) is not set to <input type="checkbox"/> h i d E .

NOTE: For more information about how parameter settings affect the controller's operation, see Chapter Five, Features.

Display	Parameter	Range (Modbus Value)	Default	Modbus Register read/write	Conditions for Parameters to Appear
ANAL	Analog Output Offset Set analog output offset.	-1999 to 9999	0	none****	Active if output 4 is equipped for retransmit (96 ___ - ___ M-___), ROUT (Analog Output 4) is not set to OFF and Setup Page Lock (Lockout Menu) is not set to hIDE .
BAUD	Baud Rate Set communications baud rate.	1200 1200 2400 2400 4800 4800 9600 9600 1920 19.2K	9600	none****	Active if output 4 is equipped for communications (96 ___ - ___ R-___ or 96 ___ - ___ U-___) and Setup Page Lock (Lockout Menu) is not set to hIDE .
ADDR	Address Set communications address.	1 to 247	1	none****	Active if output 4 is equipped for communications (96 ___ - ___ R-___ or 96 ___ - ___ U-___) and Setup Page Lock (Lockout Menu) is not set to hIDE .
****Output 4 parameters cannot be changed with the Modbus interface.					
GLBL	Global Menu				
SEt	Setup Page				
UNIT	Units Type Select US or SI units of measurement.	US propbands in degrees, reset and rate (1) SI propbands in degrees, integral and derivative (2)	US (1)	900 r/w	Active if Setup Page Lock (Lockout Menu) is not set to hIDE .
C-F	°C or °F Select the temperature scale for the input. Converts all temperature parameters.	°F °Fahrenheit (0) °C °Celsius (1)	°F (0)	901 r/w	Active if Sensor Type 1 (Input 1 Menu) is set to RTD or thermocouple and Setup Page Lock (Lockout Menu) is not set to hIDE .
ERR	Input Error Latching Select input error latching mode.	LARt latching (0) nLARt no latching (1)	nLARt (1)	607 r/w	Active if Setup Page Lock (Lockout Menu) is not set to hIDE .
FRIL	Failure Mode** Select failure mode after errors.	bPLS bumpless (0) MANn manual (1) OFF off (2)	bPLS (0)	902 r/w	Active if Setup Page Lock (Lockout Menu) is not set to hIDE .
MANn	Manual Default Power** Select output power for manual mode.	heat: 0.0 to 100.0 (0 to 1000) cool: -100.0 to 0.0 (-1000 to 0) heat/cool: -100.0 to 100.0 (-1000 to 1000)	0.0 (0)	903 r/w	Active if Failure Mode (Global Menu) is set to MANn (manual) and Setup Page Lock (Lockout Menu) is not set to hIDE .

*These parameters are added if the ramping software option has been ordered (96 ___ - ___ - AA ___).

**These parameters are removed if the ramping software option has been ordered (96 ___ - ___ - AA ___).

NOTE: For more information about how parameter settings affect the controller's operation, see Chapter Five, Features.

Display	Parameter	Range (Modbus Value)	Default	Modbus Register read/write	Conditions for Parameters to Appear
PLSP	Power Limit Set Point Set point for power limits, PLA above this point, PLb below.	rl Sensor Range Low rh Sensor Range High	rh (1)	713 r/w	Active if Setup Page Lock (Lockout Menu) is not set to hide .
PLA	High Power Limit Above Set high power limit above the power limit set point.	0.0 to 100.0 (0 to 1000) Applies to heat or cool.	100.0 (1000)	714 r/w	Active if Setup Page Lock (Lockout Menu) is not set to hide .
PLb	High Power Limit Below Set high power limit below the power limit set point.	0.0 to 100.0 (0 to 1000) Applies to heat or cool.	100.0 (1000)	715 r/w	Active if Setup Page Lock (Lockout Menu) is not set to hide .
RP	Ramping Mode** Set the single step ramp to set point mode.	OFF off (0) SErE startup only (1) SEPE startup or set point change (2)	OFF (0)	1100 r/w	Active if Local or Remote Mode (User Menu) is not r (remote set point is not active) and Setup Page Lock (Lockout Menu) is not set to hide .
RPS	Ramp Scale** Set the single step ramp scaling in degrees per hour or minute.	min minute (0) hour hour (1)	min (0)	1102 r/w	Active if Local or Remote Mode (User Menu) is not set to r , Ramping Mode (Global Menu) is not set to OFF and Setup Page Lock (Lockout Menu) is not set to hide .
RRE	Ramp Rate** Set the units or degrees set point ramp rate.	0.1 to 99.9 (1 to 999)	10.0 (1)	1101 r/w	Active if Local or Remote Mode (User Menu) is not set to r , Ramping Mode is not set to OFF and Setup Page Lock (Lockout Menu) is not set to hide .
OLPD	Open Loop Detect Turn the open loop detect feature on or off.	OFF off (0) on on (1)	OFF (0)	904 r/w	Appears if Setup Page Lock (Lockout Menu) is not set to hide .
PTYP	Program Type* Select whether the program type will be time based or rate based.	t time based (0) RRE rate based (1)	t (0)	1208 r/w	Added if ramping version of the controller is selected (96__-__-AA__).

NOTE: For more information about how parameter settings affect the controller's operation, see Chapter Five, Features.

Factory Page

The factory page contains six menus:

Display	Parameter	Range (Modbus Value)	Default	Modbus Register read/write	Conditions for Parameters to Appear
[Fcty]	Factory Page Selection Choose factory menu to enter.	[CUSE] Custom Menu** [LDC] Lockout Menu [d1R9] Diagnostics Menu [c1n1] Calibration 1 Menu [c1n2] Calibration 2 Menu** [cout] Calibration Menu			Active: Always
[CUSE] [Fcty]	Custom Menu** Factory Page				
[P1] to [P16]	Custom Prompt number** (1 to 16) Choose an operations prompt to be in custom prompt slot.	[none] none (0) [Pc2] Process 2 (1) [Pcnt] Percent Output (2) [rPSP] Ramping Set Point (3) [E5E] Event Input Status (4) [A-n7] Operation Mode (5) [Aut] Auto-tune (6) [AtSP] Auto-tune Set Point (7) [SP2] Set Point 2 (8) [E5P] Event Set Point (9) [L-r] Local or Remote Mode (10) [CAL1] Calibration Offset (11) [Pb1] Propband 1 (12) [It1] Integral 1 (13) [dE1] Derivative 1 (14) [rE1] Reset 1 (15) [rR1] Rate 1 (16) [Ct1] Cycle Time 1 (17) [db1] Dead Band 1 (18) [Pb2] Propband 2 (19) [It2] Integral 2 (20) [dE2] Derivative 2 (21) (Continued Next Page)	[P1]:[A-n7] (Operation Mode) [P2]:[Aut] (Auto-tune) [P3]:[Pcnt] (Percent Power) [P4]:[CAL1] (Calibration Offset) [P5] to [P16]:[none]	1400-1415 r/w	Active: Always

*These parameters are added if the ramping software option has been ordered (96 __ - ____ - AA __) .

**These parameters are removed if the ramping software option has been ordered (96 __ - ____ - AA __) .

NOTE: For more information about how parameter settings affect the controller's operation, see Chapter Five, Features.

Display	Parameter	Range (Modbus Value)	Default	Modbus Register read/write	Conditions for Parameters to Appear
		rE2 Reset 2 (22) rR2 Rate 2 (23) CE2 Cycle Time 2 (24) db2 Dead Band 2 (25) R2h Alarm 2 High (26) R2Lo Alarm 2 Low (27) R3h Alarm 3 High (28) R3Lo Alarm 3 Low (29) R4h Alarm 4 High R4Lo Alarm 4 Low P Proportional Term (32) i Integral Term (33) d Derivative Term (34) hY51 Hysteresis 1 (35) hY52 Hysteresis 2 (36) RhY2 Alarm Hysteresis 2 (37) RhY3 Alarm Hysteresis 3 (38) RhY4 Alarm Hysteresis 4 SP1 Set Point 1 (40)			ESHt Troubleshooting must be set to Pid PID. ESHt Troubleshooting must be set to Pid PID. ESHt Troubleshooting must be set to Pid PID.
<hr/>					
	LOC <i>Lockout Menu</i> FctY <i>Factory Page</i>				
	SP Set Point Lock Set the set point lockout level.	chn9 change (1) rERd read only (2)	chn9 (1)	1300 r/w	Active: Always
	CUSE Custom Menu Lock** Set the Custom Menu lockout level.	hide hide (0) chn9 change (1) rERd read only (2)	chn9 (1)	1304 r/w	Active: Always, unless ramping version of the controller is selected (96__-__-AA__).
	OPER Operations Page Mode Lock Set the Operations Page lockout level.	hide hide (0) chn9 change (1) rERd read only (2)	chn9 (1)	1301 r/w	Active: Always

NOTE: For more information about how parameter settings affect the controller's operation, see Chapter Five, Features.

Display	Parameter	Range (Modbus Value)	Default	Modbus Register read/write	Conditions for Parameters to Appear
SEt	Setup Page Lock Set the Setup Page lockout level.	hIDE hide (0) chng change (1) REAd read only (2)	chng (1)	1302 r/w	Active: Always
CRl	Calibration Menu Lock Set the calibration menus lockout level.	hIDE hide (0) chng change (1) REAd read only (2)	chng (1)	1305 r/w	Active: Always
PRoG	Program Menu Lock* The lockout menu will allow the user to set different levels of user lockout for he program menu.	hIDE hide (0) chng change (1) REAd read only (2)	chng (1)	1314 r/w	Active if ramping version of the controller is selected (96__-__-AA__).
dIRg Fcty	Diagnostics Menu Factory Page	Enter dIRg mode	(1789)	1512 w	
MDL	Model Number Read the model number of the controller.	96	96	0 r	Active: Always
DATE	Date of Manufacture Displays date as WEEK:YEAR (WWYY).	0196 to 9999	none	5 r	Active: Always
Sn1	Serial Number 1 Read the first four digits of the serial number.	0 to 9999	none	1 r	Active: Always
Sn2	Serial Number 2 Read the last four digits of the serial number.	0 to 9999	none	2 r	Active: Always
SOFT	Software ID Number Read the software ID number.	0 to 9999	none	3 r	Active: Always

NOTE: For more information about how parameter settings affect the controller's operation, see Chapter Five, Features.

Display	Parameter	Range (Modbus Value)	Default	Modbus Register read/write	Conditions for Parameters to Appear
rEu	Software Revision Read software revision number.	0.00 to 99.99	none	4 r	Active: Always
1EY2	Input 2 Hardware Enabled Read the input 2 hardware type.	nonE none (0) PrEE process event (5)	(0)	9 r	Active: Always
0EY1	Output 1 Hardware Read the output 1 hardware type.	nonE none (0) rELY relay (1) SSr solid-state relay (2) dc dc (3) Proc process (4)	(0)	16 r	Active: Always
0EY2	Output 2 Hardware Read the output 2 hardware type.	nonE none (0) rELY relay (1) SSr solid-state relay (2) dc dc (3) Proc process (4)	(0)	17 r	Active: Always
0EY3	Output 3 Hardware Read the output 3 hardware type.	nonE none (0) rELY relay (1)	(0)	18 r	Active: Always
0EY4	Output 4 Hardware Read the output 4 hardware type.	nonE none (0) rELY relay (1) Proc process (4) 485 (6) 232 (7)	(0)	19 r	Active: Always
EOUt	Test Output Turns on specific output.	nonE none (0) out1 output 1 (1) out2 output 2 (2) out3 output 3 (3) out4 output 4 (4) ALL all outputs (5)	nonE (0)	1514 r/w	Active: Must be in d1R9 mode
d1SP	Test Display Test the indicator lights on the front panel.	OFF turn off the cyclic display test (0) on turn on the cyclic display test (1)	OFF (0)	1513 r/w	Active: Must be in d1R9 mode
hrES	High Resolution Displays high resolution input value.	-199.9 to 199.9 (-1999 to 1999)	none	1707 r	Active: Always

NOTE: For more information about how parameter settings affect the controller's operation, see Chapter Five, Features.

Display	Parameter	Range (Modbus Value)	Default	Modbus Register read/write	Conditions for Parameters to Appear
RP7b	Ambient Temperature Read the ambient temperature in 0.1 degrees Fahrenheit.		none	1500 r	Active: Always
RCnt	Ambient A-D Counts Displays the raw ambient channel A-D counts.		none	1501 r	Active: Always
cnt1	Channel 1 A-D Counts Displays the raw channel 1 A-D counts.		none	1504 r	Active: Always
cnt2	Channel 2 A-D Counts Displays the raw channel 2 A-D counts.		none	1505 r	Active: Always
ESht	Troubleshooting Helps solve problems with the controller.	<input type="checkbox"/> no <input type="checkbox"/> Pid enables PID terms in custom menu <input type="checkbox"/> COFF sends modbus packet every 1 second	<input type="checkbox"/> Pid		Proportional term 205 Integral term 206 Derivative term 207
LINE	Line Frequency Displays the AC line frequency in Hz.		none	1515 r	Active: Always (Model 96A - available only with ac input.)
cin1	Calibration 1 Menu	Enter d1R9 mode	(1789)	1512 w	
FCEY	Factory Page	Enter cin1 mode	(1415)	1600 w	
rSE	Restore Factory Calibration Restore factory calibration. Does not affect operations and setup parameters.	<input type="checkbox"/> no no (0) <input type="checkbox"/> YES yes (1)	<input type="checkbox"/> no (0)	1601 w	Active if Calibration Lock (Lock-out Menu) is not set to hidE .
dFLt	Default Settings Restore default settings.	<input type="checkbox"/> no no (0) <input type="checkbox"/> YES yes (800)	<input type="checkbox"/> no (0)	1602 w	Active if Calibration Lock (Lock-out Menu) is not set to hidE .

NOTE: Complete calibration menus and parameters are explained at Watlow's web site, <http://www.watlow.com/literature/prodtechinfo>. Search on **96 calibration manual**.

NOTE: For more information about how parameter settings affect the controller's operation, see Chapter Five, Features.

Chapter Seven Ramping

Program Menu Prompts

Entering the Program Menu: Press the **⏩** Advance key to enter the Program Menu while the program is on hold or not running.

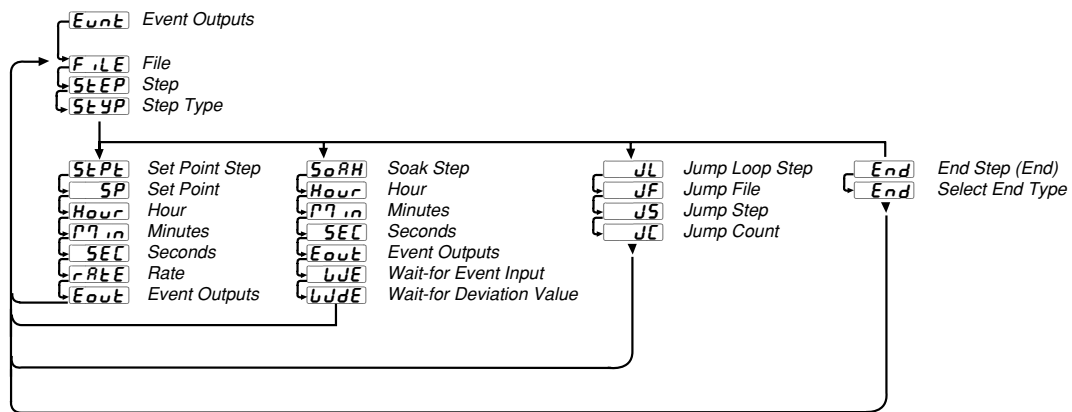

Figure 7.1 – The Program Menu

Note: The Program Menu will only appear if the ramping software option has been ordered (96 _ _ - _ _ _ - AA _ _) .

Display	Parameter	Range (Modbus Value)	Default	Modbus Register read/write	Conditions for Parameters to Appear
Eunt	Event Outputs Manually change the event output status while the program is not running.	<input type="checkbox"/> OFF (0) <input type="checkbox"/> 2 (1) <input type="checkbox"/> 3 (2) <input type="checkbox"/> 2 3 (3)	<input type="checkbox"/> OFF (0)	1268 r/w	Active if hardware is present for Outputs 2, 3, or 4 and the parameters are set to Eunt . Selecting a number to appear will turn the respective event output on.
FILE	File Represents the profile to be edited or viewed.	<input type="text"/> 1 (1 to 2) <input type="text"/> 2	<input type="text"/> 1 (1)		
STEP	Step Represents the current step of the profile to be edited or viewed.	<input type="text"/> 1 (1 to 8) to <input type="text"/> 8	<input type="text"/> 1 (1)		
SEYP	Step Type Select from four different step types.	<input type="checkbox"/> SEPT Set Point (0) <input type="checkbox"/> SOAH Soak (1) <input type="checkbox"/> JL Jump Loop (2) <input type="checkbox"/> End End (3)	<input type="checkbox"/> End (3)	See p. 7.7	

Display	Parameter	Range (Modbus Value)	Default	Modbus Register read/write	Conditions for Parameters to Appear
SEPE <i>Set Point Step</i>					
SP	Set Point Indicates ending set point value the controller ramps to during the set point step.	OFF (-32768) rL1 rH1	75°F/24°C or rL value if rL ≥ 75°F/24°C or if rH ≤ 75°F/24°C	See p. 7.7	Active: Always
Hour	Hour The number of hours, (plus Min and Sec parameters) equal the total step time to achieve the ending set point under the SEYP step type.	0 to 99	0	See p. 7.7	Active if the value set for PEYP is E1 , or time based profile.
Min	Minutes The number of minutes, (plus Hour and Sec parameters) equal the total step time to achieve the ending set point under the SEYP step type.	0 to 59	0	See p. 7.7	Active if the value set for PEYP is E1 , or time based profile.
SEC	Seconds The number of seconds, (plus Hour and Min parameters) equal the total step time to achieve the ending set point under the SEYP step type.	0 to 59	0	See p. 7.7	Active if the value set for PEYP is E1 , or time based profile.
RATE	Rate Indicates rate at which the set point changes in degrees per minute.	0.0 to 360.0 °F 0.0 to 200.0 °C 0.0 to 360.0 Units	0.0	See p. 7.7	Active if the value set for PEYP is RATE or rate based profile.
Event	Event Outputs Selects whether the event output(s) are on or off during the program step.	OFF (0) 2 (1) 3 (2) 2 3 (3) 4 **** 2 4 **** 3 4 **** 2 3 4 ****	OFF (0)	See p. 7.7	Active if hardware is present for Outputs 2, 3 or 4 and the parameters are set to Event . Selecting a number to appear will turn the respective event output on during the program step.

****Output 4 parameters cannot be changed with the Modbus interface.

Display	Parameter	Range (Modbus Value)	Default	Modbus Register read/write	Conditions for Parameters to Appear
SoRH	Soak Step				
Hour	Hour The number of hours, (plus Min and Sec parameters) equal the total soak step time at set point under the SoRH step type.	<input type="text" value="0"/> to <input type="text" value="99"/>	<input type="text" value="0"/>	See p. 7.7	Always displayed in this menu.
Min	Minutes The number of minutes, (plus Hour and Sec parameters) equal the total soak step time at set point under the SoRH step type.	<input type="text" value="0"/> to <input type="text" value="59"/>	<input type="text" value="0"/>	See p. 7.7	Always displayed in this menu.
Sec	Seconds The number of seconds, (plus Hour and Min parameters) equal the total soak step time at set point under the SoRH step type.	<input type="text" value="0"/> to <input type="text" value="59"/>	<input type="text" value="0"/>	See p. 7.7	Always displayed in this menu.
Event	Event Outputs Selects whether the event output(s) are on or off during the program step.	<input type="text" value="OFF"/> (0) <input type="text" value="2"/> (1) <input type="text" value="3"/> (2) <input type="text" value="2 3"/> (3) <input type="text" value="4"/> **** <input type="text" value="2 4"/> **** <input type="text" value="3 4"/> **** <input type="text" value="234"/> ****	<input type="text" value="OFF"/> (0)	See p. 7.7	Active if hardware is present for Outputs 2, 3, or 4 and the parameters are set to Event . Selecting a number to appear will turn the respective event output on during the program step.
WJE	Wait-for Event Input The program will not begin to decrement the soak time during the programmed step until the event input condition has been satisfied	<input type="text" value="OFF"/> (0) <input type="text" value="ON"/> (1)	<input type="text" value="OFF"/> (0)	See p. 7.7	Active if the parameter for Input 2 En is set to WJE .
WdE	Wait-for Deviation Value The program will not begin to decrement the soak time during the programmed step until process value is equal to or within the wait-for deviation value setting.	<input type="text" value="OFF"/> (-32768) <input type="text" value="0"/> to <input type="text" value="99"/>	<input type="text" value="OFF"/> (-32768)	See p. 7.7	Always displayed in this menu.

Display	Parameter	Range (Modbus Value)	Default	Modbus Register read/write	Conditions for Parameters to Appear
<input type="checkbox"/> JL	Jump Loop Step				
<input type="checkbox"/> JF	Jump file Selects the File which is to be jumped to. This is a zero-time step.	<input type="text" value="1"/> to <input type="text" value="2"/>	Current File	See p. 7.7	
<input type="checkbox"/> JS	Jump Step Selects the Step which is to be jumped to. This is a zero-time step.	<input type="text" value="1"/> to <input type="text" value="8"/>	<input type="text" value="1"/>	See p. 7.7	
<input type="checkbox"/> JC	Jump Count Indicates the number of times the Jump is to be done.	<input type="text" value="0"/> to <input type="text" value="255"/>	<input type="text" value="0"/>	See p. 7.7	
<input type="checkbox"/> End	End Step				
<input type="checkbox"/> End	End Selects the state of the control and auxiliary outputs when a profile is ended.	<input type="text" value="HoLd"/> (0) <input type="text" value="OFF"/> (1)	<input type="text" value="HoLd"/> (0)	See p. 7.7	When selected as <input type="text" value="HoLd"/> , the control and auxiliary outputs will be enabled to maintain the same state as in the last step in the program just completed. When selected as <input type="text" value="OFF"/> , the control and auxiliary outputs will be disabled and <input type="text" value="OFF"/> is shown in the lower display.

How to Navigate with the Ramping Menus

	Pre-run Menu	Program Menu	Run Menu
Enter menu	Press the <input type="text" value="∞"/> Infinity key.	Press the <input type="text" value="⏩"/> Advance key.	Press the <input type="text" value="∞"/> Infinity key two times or one time if the profile indicator is flashing.
Scroll thru menu.	Press the <input type="text" value="⏩"/> Advance key.	Press the <input type="text" value="⏩"/> Advance key.	Press the <input type="text" value="⏩"/> Advance key.
Change prompt values.	Press <input type="text" value="⬆"/> Up and <input type="text" value="⬇"/> Down arrow keys.	Press <input type="text" value="⬆"/> Up and <input type="text" value="⬇"/> Down arrow keys.	Menu is read only.
Exit menu.*	Press the <input type="text" value="⏩"/> Advance key repeatedly.	Press the <input type="text" value="∞"/> Infinity key.	Press the <input type="text" value="⏩"/> Advance key repeatedly.

*Exit menu refers to returning back to the display of process value in the upper display and active set point value in the lower display. The ramping set point will be active while running a profile and the manual adjustable set point will be active when a profile is not running.

NOTE: For more information about how parameter settings affect the controller's operation, see Chapter Five, Features.

Pre-run and Run Menus

The Pre-run and Run menu prompts are only visible when in the Pre-Run or Run mode.

The Pre-run mode is entered by pressing the **∞** Infinity key one time while at the Home Page location. The profile indicator light flashes while in the Pre-run mode. The Pre-run menu consists of the **FILE**, **STEP**, **RESU** and prompts. The Pre-run menu allows the user to select a profile and step number to run or to resume running a profile. The Pre-run menu contains these three prompts and does not revolve around in a continuous loop. Pressing the **⏩** Advance key at the **RESU** prompt will not advance you back to the top of the Pre-run menu. If the **⏩** Advance key is pressed at the **RESU** prompt, the user will exit out of the Pre-run menu and return to the display of process/current set point.

The Run mode is active when a program is running. The Run mode is entered by pressing the **∞** Infinity key one time while in the Pre-run menu. The profile indicator light will be full on while in the Run mode. The **F-SE** file-step prompt is visible in the Run

menu and shows the current file and step number of the running profile. Other prompts in the Run menu show the target end set point, as well as status for time remaining, ramp rate, wait-for, and jump count if relevant.

Pre-run Menu

FILE
STEP
RESU (File number - step number)

Run Menu

F-SE File number - step number
ENSP End set point for step
Hour Hours remaining in step
Min Minutes remaining in step
SEC Seconds remaining in step
RATE Ramp rate in minutes for step
WFE Wait-for event
WJDE Wait-for process deviation value selection for step
EJC Elapsed jump count for last jump step

Running a Series 96 Profile

1. You must be at the Home Page location before you can begin running a profile. Start your profile by entering the pre-run menu. Enter the pre-run menu by pressing the infinity key.
2. The profile indicator LED begins flashing. The upper display shows the file number to be run and the bottom display shows the **FILE** parameter. Use the **⬆** Up and **⬇** Down arrow keys to select which profile number to run.
3. Press the **⏩** Advance key, the upper display shows the step number to be run and the bottom display shows the **STEP** parameter. Use the **⬆** Up and **⬇** Down arrow keys to select which step number to start ramping at.
4. Press the **∞** Infinity key again and the profile will start running. If not pressed within approximately one minute, the controller will automatically exit out of a pre-run mode. If the **∞** Infinity key is pressed within one minute, the profile indicator LED will

change from flashing to being continually lit to indicate the profile is now running. The upper display shows the process value and the lower display will show the ramping set point or soak set point value.

5. You may step through the Run menu parameters with the **⏩** Advance key while the profile is running. The Run menu will show the file/step number, and what the parameters are set to. At any time, you may press the **∞** Infinity key to stop the profile. To resume running the profile where it was stopped, press the **∞** Infinity key once; the profile indicator LED begins flashing. Now, press the **⏩** Advance key repeatedly until the **RESU** parameter appears in the lower display; once again, press the **∞** Infinity key and the profile resumes running. After the profile has ended, the profile indicator LED will turn off and the lower display will read **OFF** or the last profile step set point depending on the **End** prompt setting.

Resume a Profile

To resume a halted profile, from the Home Page, press the **∞** Infinity key once to enter the Pre-run Menu. Press the **⏩** Advance key twice until the **RESU** parameter appears in the lower display. The lower display will show **RESU** and the upper display will show the file and step number that will be resumed (file-step). Press the **∞** Infinity key again, the profile resumes, and the profile indicator LED is lit. You can only resume at the exact step you left off on. If you halt a running profile and make changes to the current step, you cannot resume the

profile. The **RESU** parameter only appears when a running profile has been halted.

To Run your profile... Press the **∞** Infinity key twice.

To Stop a running profile... Press the **∞** Infinity key once.

To Resume a halted profile... Press the **∞** Infinity key once, press the **⏩** Advance key repeatedly until the **RESU** parameter appears in the lower display, and press the **∞** Infinity key.

Jump-loops

The Series 96 can jump forward or backwards at any step. You cannot jump-loop to the step that you are on.

Example: Step 1 **SEPL** Set Point Step
Step 2 **SEPL** Set Point Step
Step 3 **SORH** Soak Step
Step 4 **SEPL** Set Point Step
Step 5 **JL** Jump-loop **JF** = 1 **JS** = 2 **JC** = 1
Step 6 **End** End

In this example the program will execute steps 2 through 4 a total of 2 times. This includes the initial pass and the pass associated with the Jump Count of 1 **JC**. Following the second pass the **End** End step (Step 6) will be executed and the program will end.

Your **JC** Jump Count can be any number from 0 to 255. If you enter 0, this will be an infinite loop and never progresses to Step 6.

When **JF** Jump File is not set to the current program file, the profile may jump to any step of the other file.

The Wait-for Functions of the Soak Step

There are two wait-for functions. The first is **LJE** Wait-for Event. The profile will wait-for the programmed event input condition to occur. The desired event condition is programmed by the **EN** parameter. If the **LJE** parameter is set to **OFF** the function will be ignored.

The second wait-for function is **LJDE** Wait-for Process Deviation Value. If a value is entered for this prompt, the profile will wait at this step until the desired process value is equal to or within the **LJDE** Wait-for Process Deviation Value band. Even

though only one numeric number is programmed to wait-for, this absolute number represents both a positive and negative window around the desired process value.

Both wait-for functions (if enabled) must be satisfied before the time entered in the **SORH** Soak step will begin to decrement. Once the wait-for condition has been satisfied, the soak step time will continue to decrement regardless of event input or process changes during the remainder of the profile step.

Event Input Functions

In addition to being able to set the event input as a **LJE** Wait-for Event, the event input can also be programmed to pause a running profile, start a profile, hold a profile, or abort a profile.

If the event input is set to **PAUS** Pause a profile, satisfying the event input condition will toggle the profile between hold and resume.

If the event input is set to **hold** Hold, the profile will end when the event input condition is satisfied. The controller will return to the non-ramping mode and will continue to control the outputs by holding the last active profile step set point and event output settings.

If the event input is set to **FIL1** or **FIL2**, Profile 1 or Profile 2, the control will begin running the designated profile number selected when the event input condition has been satisfied if a profile is not currently running. This will begin at step 1.

If the event input is set to **ABSP** Abort Set Point, the profile will end when the event input condition is satisfied. The controller will return to the non-ramping mode and continue to operate by using the set point value programmed at the **ABSP** parameter. The event output settings will remain in the same state as the profile step settings when the profile was aborted.

NOTE: For more information about how parameter settings affect the controller's operation, see Chapter Five, Features.

Series 96 Ramping Modbus Register Numbers

Command Registers (Write Only) Send to activate				Absolute Monitor	Relative Current Profile Registers	Parameter Registers (Read Only)
41210	1209	Resume Profile	1	45001	5000	File
41211	1210	Hold Profile	1	45002	5001	Step
40001	4000	Start File	1 or 2	45003	5002	Step Type
40002	4001	Start Step	1 - 8	45004	5003	Wait for Event Input ⁴
40003	4002	Start Profile	5	45005	5004	Wait for Deviation (process input) ⁴
				45006	5005	Event Output
				45007	5006	Hours
				45008	5007	Minutes
				45009	5008	Seconds
				45010	5009	Current Set Point
				45011	5010	Jump Count
				45012	5011	End Set Point
				45013	5012	Rate
				45014	5013	Profile State

Profile Definition Registers (Read and Write)

Note: For absolute numbers, add 40001 to each relative number.

Parameter	File 1 Step 1	File 1 Step 2	File 1 Step 3	File 1 Step 4	File 1 Step 5	File 1 Step 6	File 1 Step 7	File 1 Step 8	File 2 Step 1	File 2 Step 2	File 2 Step 3	File 2 Step 4	File 2 Step 5	File 2 Step 6	File 2 Step 7	File 2 Step 8
Step Type	5020	5033	5046	5059	5072	5085	5098	5111	5124	5137	5050	5163	5176	5189	5202	5215
End Set Point	5021	5034	5047	5060	5073	5086	5099	5112	5125	5138	5151	5164	5177	5190	5203	5216
Hours ^{1 or 4}	5022	5035	5048	5061	5074	5087	5100	5113	5126	5139	5152	5165	5178	5191	5204	5217
Minutes ^{1 or 4}	5023	5036	5049	5062	5075	5088	5101	5114	5127	5140	5153	5166	5179	5192	5205	5218
Seconds ^{1 or 4}	5024	5037	5050	5063	5076	5089	5102	5115	5128	5141	5154	5167	5180	5193	5206	5219
Rate ^{2 and 3}	5025	5038	5051	5064	5077	5090	5103	5116	5129	5142	5155	5168	5181	5194	5207	5220
Event Output ^{2,3 or 4}	5026	5039	5052	5065	5078	5091	5104	5117	5130	5143	5156	5169	5182	5195	5208	5221
Waitfor Event Input ⁴	5027	5040	5053	5066	5079	5092	5105	5118	5131	5144	5157	5170	5183	5196	5209	5222
Waitfor Deviation (Process Input) ⁴	5028	5041	5054	5067	5080	5093	5106	5119	5132	5145	5158	5171	5184	5197	5210	5223
Jump File ⁵	5029	5042	5055	5068	5081	5094	5107	5120	5133	5146	5159	5172	5185	5198	5211	5224
Jump Step ⁵	5030	5043	5056	5069	5082	5095	5108	5121	5134	5147	5160	5173	5186	5199	5212	5225
Jump Count ⁵	5031	5044	5057	5070	5083	5096	5109	5122	5135	5148	5161	5174	5187	5200	5213	5226
End Type ⁶	5032	5045	5058	5071	5084	5097	5110	5123	5136	5149	5162	5175	5188	5201	5214	5227

* Register is disabled or unavailable.

¹ Register is only available if program type is set to Time.

² Register is only available if program type is set to Rate.

³ Register is only available if step type is set to Set Point.

⁴ Register is only available if step type is set to Soak.

⁵ Register is only available if step type is set to Jump.

⁶ Register is only available if step type is set to End.

Note: Data to be written to registers that are unavailable for a particular step type will be ignored.

Register 106 (Alarm 2 Status)

Register 110 (Alarm 3 Status)

0	No Alarm Exists
1	Alarm High State
2	Alarm Low State
3	Alarm High Latched State
4	Alarm Low Latched State
5	Alarm High Silenced State
6	Alarm Low Silenced State
7	Alarm High Latched & Silenced State
8	Alarm Low Latched & Silenced State
9	Alarm Waiting for In Range State
10	Alarm Disabled State
11	Alarm Error State

Register

NOTE: For more information about communicating with Watlow controllers, go to www.watlow.com and download the Data Communications Reference: Electronic User's Manual. It is located under Literature, User's Manuals, English and search on *data communications reference*.

A

Appendix

Troubleshooting Alarms and Errors

Indication	Probable Cause(s)	Corrective Action
Power <ul style="list-style-type: none">No power.	<ul style="list-style-type: none">Power to unit may be off.Fuse may be blown.Breaker may be tripped.Safety interlock door switch etc. may be activated.Separate system limit control may be latched.Wiring may be open.Input Power may be incorrect.	<ul style="list-style-type: none">Check switches, fuses, breakers, interlocks, limits, connectors, etc. for energized condition and proper connection.Measure power upstream for required level. Check part number for input power required.Check wire size.Check for bad connections.
Communications <ul style="list-style-type: none">Unit will not communicate.	<ul style="list-style-type: none">Address parameter may be incorrectly set.Baud rate parameter may be incorrectly set.Unit-to-unit daisy chain may be disconnected.Communications wiring may be reversed, shorted or open.EIA-485 converter box may be incorrectly wired.Computer COM port may be incorrectly set up.Communications software setup or address may be incorrect.Protocol or parity may be wrong, should be 8, n, 1.Application software not working properly.May need termination and pull-up and pull-down resistors.	<ul style="list-style-type: none">Check comms setup menu and set to correct address.Check comms setup menu and set to correct baud rate.Look for a break in the daisy chain.Verify correct connections and test wiring paths.Check converter box wiring and its documentation.Reconfigure computer's COM port setup and verify communications ok.Check the communication card documentation for settable variables and operational testing.Restart COMS software and check for settings agreement. Verify the COM bus is active.Verify operation with Watlow comms tool.Add termination resistors per EIA-485 standards if using this option.

Indication	Probable Cause(s)	Corrective Action
Input Error (error number in top display, % LED lit, percent power in bottom)		
<ul style="list-style-type: none"> Input is in error condition. Err1 Underflow Err2 Under Sensor Err3 Over Sensor Err4 Overflow 	<ul style="list-style-type: none"> The sensor may be improperly wired. Sensor wiring may be reversed, shorted or open. Input type setting may be for the wrong sensor/may not be calibrated. Input type setting may be for the wrong sensor/may not be calibrated. Ambient temperature may be too hot or too cold. The open loop detect shows a broken sensor. The calibration offset parameter is set much too high or low. Calibration may have been corrupted. 	<ul style="list-style-type: none"> Check sensor connections. Check sensor connections and sensor wiring. Change the Sensor Type parameter to match the sensor hardware. Change the Sensor Type parameter to match the sensor hardware. Try Restore Factory Calibration (Cal. 1 Menu). Verify that the temperature surrounding the controller is 32 to 149°F (0 to 65°C). Check sensor function. The Open Loop Detect parameter indicates it may be broken. Check the Calibration Offset parameter value; set it to the correct value. Restore factory calibration. See pg. 6.22 for selecting 5E = 4E5.
Alarms		
<ul style="list-style-type: none"> Alarm won't occur. 	<ul style="list-style-type: none"> Alarm output may be off. Alarm set points may be incorrect. Alarm may be silenced. Alarm sides may be incorrect. Controller may be in diagnostics mode. 	<ul style="list-style-type: none"> Configure output as an alarm. Check alarm set points. To clear the alarm, correct the alarm condition; check to see if the alarm is latched. Check the alarm sides setting. Check the alarm type setting.
<ul style="list-style-type: none"> Alarm won't clear. 	<ul style="list-style-type: none"> Alarm may be latched. Alarm set points may be incorrect. Alarm hysteresis may be incorrect. Input may be in error condition. 	<ul style="list-style-type: none"> Check the alarm logic for compatibility with system peripherals and annunciators. Check the power limit setting. Check the operation mode. Check the alarm output function. Check the °C or °F setting. Check the calibration offset value; set it to a lower level.

Unit Errors (error number in top display,error message in bottom display)		
Er 4	RAM	<ul style="list-style-type: none"> There is a RAM malfunction.
Er 5	EECS	<ul style="list-style-type: none"> The EEPROM data is corrupted.
Er 6	PROM	<ul style="list-style-type: none"> There is a PROM malfunction.
Er 7	HRrd	<ul style="list-style-type: none"> There is a logic hardware problem.
Er 8	PLU9	<ul style="list-style-type: none"> Module error.
Er 9	cnF9	<ul style="list-style-type: none"> Configuration error. Module in invalid position.
Er 10	chn9	<ul style="list-style-type: none"> Module changed.
Er 11	SoFE	<ul style="list-style-type: none"> New firmware is installed.
Er 12	cAL	<ul style="list-style-type: none"> Calibration data is corrupted.
Er 13	Atod	<ul style="list-style-type: none"> There is an analog-to-digital hardware failure.
Er 14	EEhd	<ul style="list-style-type: none"> There is an EEPROM hardware problem.
Er 15	nEUJ	<ul style="list-style-type: none"> It is the new unit's first power up.
Er 16	Addr	<ul style="list-style-type: none"> There is an EEPROM hardware problem.

Series 96 Modbus Register Numbers

Relative	Parameters	Relative	Parameters	Relative	Parameters
0	Model Number	332	Silence Alarms	721	Latching 2
1	Serial Number 1	340	Alarm 3 Low	722	Silencing 2
2	Serial Number 2	341	Alarm 3 High	723	Alarm Active Sides 2
3	Software ID Number	500	Propband 1	724	Alarm Logic 2
4	Software Revision	501	Integral 1	725	Alarm Annunciation 2
5	Date of Manufacture	502	Reset 1	734	Output 3
9	Input 2 Hardware Enabled	503	Derivative 1	736	Alarm 3 Type
16	Output 1 Hardware	504	Rate 1	737	Alarm Hysteresis 3
17	Output 2 Hardware	505	Dead Band 1	738	Latching 3
18	Output 3 Hardware	506	Cycle Time 1	739	Silencing 3
19	Output 4 Hardware	507	Hysteresis 1	740	Alarm Active Sides 3
24	Disable Nonvolatile Memory	509	Burst 1	741	Alarm Logic 3
100	Process 1	510	Propband 2	742	Alarm Annunciation 3
101	Error 1	511	Integral 2	900	Units Type
103	Percent Output	512	Reset 2	901	°C or °F
104	Actual 2	513	Derivative 2	902	Failure Mode
105	Process 2	514	Rate 2	903	Manual Default Power
106	Alarm 2 Status	515	Dead Band 2	904	Open Loop Detect
110	Alarm 3 Status	517	Hysteresis 2	1060	Event Function
200	Operation Mode	519	Burst 2	1061	Event Condition
201	Event Input Status	600	Sensor Type 1	1100	Ramping Mode
202	Remote Set Point	601	Input 1	1101	Ramp Rate
203	Ramping Set Point	602	Range Low 1	1102	Ramp Scale
204	PID Power	603	Range High 1	1208	Program Type
205	Prop Term	604	Input Software Filter 1	1211	Abort Set Point
206	Integral Term	605	Calibration Offset 1	1300	Set Point Menu Lock
207	Derivative Term	606	Decimal 1	1301	Operations Page Mode Lock
209	System Error	607	Input Error Latching	1302	Setup Page Lock
210	Open Loop Error	611	Input 2	1304	Custom Menu Lock
300	Set Point 1	612	Range Low 2	1305	Calibration Menu Lock
301	Auto-Manual Operation Mode	613	Range High 2	1314	Program Menu Lock
304	Auto-tune Set Point 1	615	Calibration Offset 2	1400-1415	Custom Prompt Number (1-16)
305	Auto-tune Start 1	700	Output 1	1500	Ambient Temperature
306	Event Set Point 1	701	Process 1 Type	1501	Ambient A-D Counts
310	Manual Set Point	713	Power Limit Set Point	1504	Channel 1 A-D Counts
311	Clear Input Errors	714	High Power Limit Above	1505	Channel 2 A-D Counts
316	Local-Remote (L-r)	715	High Power Limit Below	1513	Test Display
319	Set Point 2	717	Output 2	1514	Test Output
321	Alarm 2 Low	718	Process 2 Type	1515	Line Frequency
322	Alarm 2 High	719	Alarm 2 Type	1601	Restore Factory Calibration
331	Clear Alarms	720	Alarm Hysteresis 2	1602	Default Settings

Special Modbus Functions

The following are modbus registers with special functions. Disable Non-volatile Memory (24); Alarm Status Output 2 (106); Alarm Status Output 3 (110); Auto-Manual Operation Mode (200); Clear Input Errors (311); Clear Alarms (331); Silence Alarms (332).

A “0” indicates an active state. Send “1” to the register to activate the function. It will automatically reset to “0” when the function is complete.

Note: For Absolute Modbus numbers, add 40001 to the Relative number.

Note: Refer to p. 7.7 for Modbus Register Numbers for ramping parameters.

Declaration of Conformity

Series 96

WATLOW Winona, Inc.
1241 Bundy Boulevard
Winona, Minnesota 55987 USA



Declares that the following product:

English

Designation: Series 96
Model Number(s): 96 (A or B) (0 or 1) - (C, D, F or K) (A, C, D, F or K) (A or D) (A, D, M, R or U) - (Any four letters or numbers)
Classification: Temperature control, Installation Category II, Pollution degree 2
Rated Voltage: 100 to 240 V~ (ac) or 24 to 28 V≈ (ac or dc)
Rated Frequency: 50 or 60 Hz
Rated Power Consumption: 7VA maximum

Meets the essential requirements of the following European Union Directives by using the relevant standards show below to indicate compliance.

89/336/EEC Electromagnetic Compatibility Directive

EN 61326:1997 With A1:1998 - Electrical equipment for measurement, control and laboratory use - EMC requirements (Industrial Immunity, Class A Emissions).

EN 61000-4-2:1996 With A1, 1998 - Electrostatic Discharge Immunity
EN 61000-4-3:1997 - Radiated Field Immunity
EN 61000-4-4:1995 - Electrical Fast-Transient / Burst Immunity
EN 61000-4-5:1995 With A1, 1996 - Surge Immunity
EN 61000-4-6:1996 - Conducted Immunity
EN 61000-4-11:1994 Voltage Dips, Short Interruptions and Voltage Variations Immunity
EN 61000-3-2:1995 With A1-3:1999 - Harmonic Current Emissions
EN 61000-3-3:1995 With A1:1998 - Voltage Fluctuations and Flicker

73/23/EEC Low-Voltage Directive

EN 61010-1:1993 With A1:1995 Safety Requirements of electrical equipment for measurement, control and laboratory use. Part 1: General requirements

déclare que le produit suivant :

Français

Désignation : Séries 96
Numéros de modèles : 96 (A ou B) (0 ou 1) - (C, D, F ou K) (A, C, D, F ou K) (A ou D) (A, D, M, R, ou U) (N'importe quelle combinaison de quatre lettres ou chiffres)
Classification : Régulation de température, Catégorie d'installation II, Degré de pollution 2
Tension nominale : 100 à 240 V~ (c.a) ou 24 à 28 V ≈ (c.a ou c.c)
Fréquence nominale : 50 ou 60 Hz
Consommation d'alimentation nominale : 7 VA maximum

Répond aux normes essentielles des directives suivantes de l'Union européenne en utilisant les standards normalisés ci-dessous qui expliquent les normes auxquelles répondre :

Directive 89/336/CEE sur la compatibilité électromagnétique

EN 61326:1997 avec A1 :1998 - Matériel électrique destiné à l'étalonnage, au contrôle et à l'utilisation en laboratoire - Exigences CEM (Immunité industrielle, Émissions de catégorie A).

EN 61000-4-2:1996 Avec A1, 1998 - Immunité aux décharges électrostatiques
EN 61000-4-3:1997 - Immunité aux champs de radiation
EN 61000-4-4:1995 - Immunité contre les surtensions électriques rapides/ Rafale
EN 61000-4-5:1995 avec A1, 1996 - Immunité contre les surtensions
EN 61000-4-6:1996 - Immunité conduite
EN 61000-4-11:1994 Immunité contre les écarts de tension, interruptions courtes et variations de tension
EN 61000-3-2:1995 avec A1-3 :1999 - Emissions de courant harmoniques
EN 61000-3-3:1995 avec A1 :1998 - Fluctuations et vacillements de tension

Directive 73/23/CEE sur les basses tensions

EN 61010-1:1993 avec A1 :1995 Normes de sécurité du matériel électrique pour la mesure, le contrôle et l'utilisation en laboratoire. 1ère partie : Conditions générales

Erklärt, dass das folgende Produkt:

Deutsch

Bezeichnung: Serie 96
Modell-Nummern: 96 (A oder B) (0 oder 1) - (C, D, F oder K) (A, C, D, F oder K) (A oder D) (A, D, M, R oder U) - (Beliebige vier Ziffern oder Buchstaben)
Klassifikation: Temperaturregler, Installationskategorie II, Verschmutzungsgrad 2
Nennspannung: 100 bis 240 V~ (ac) oder 24 bis 28 V ≈ (AC oder DC)
Nennfrequenz: 50 oder 60 Hz
Nennstromverbrauch: Max. 7 VA

Erfüllt die wichtigsten Normen der folgenden Anweisung(en) der Europäischen Union unter Verwendung des wichtigsten Abschnitts bzw. der wichtigsten Abschnitte die unten zur Befolgung aufgezeigt werden.

89/336/EEC Elektromagnetische Kompatibilitätsrichtlinie

EN 61326:1997 mit A1:1998 - Elektrisches Gerät für Messung, Kontrolle und Laborgebrauch - EMV-Anforderungen (Störfestigkeit Industriebereich, Klasse A Emissionen)

EN 61000-4-2:1996 mit A1, 1998 - Störfestigkeit gegen elektronische Entladung
EN 61000-4-3:1997 - Störfestigkeit gegen Strahlungsfelder
EN 61000-4-4:1995 - Störfestigkeit gegen schnelle Stöße/Burst
EN 61000-4-5:1995 mit A1, 1996 - Störfestigkeit gegen Überspannung
EN 61000-4-6:1996 - Geleitete Störfestigkeit
EN 61000-4-11:1994 Störfestigkeit gegen Spannungsabfall, kurze Unterbrechungen und Spannungsschwankungen
EN 61000-3-2:1995 mit A1-3:1999 - Harmonische Stromemissionen
EN 61000-3-3:1995 mit A1:1998 - Spannungsfuktationen und Flimmern
EN 61000-3-3: 1995 Grenzen der Spannungsschwankungen und Flimmern

73/23/EEC Niederspannungsrichtlinie

EN 61010-1:1993 mit A1:1995 Sicherheitsanforderungen für elektrische Geräte für Messungen, Kontrolle und Laborgebrauch. Teil 1: Allgemeine Anforderungen

Declara que el producto siguiente:

Español

Designación: Serie 96
Números de modelo: 96 (A o B) (0 ó 1) - (C, D, F o K) (A, C, D, F o K) (A o D) (A, D, U, M o R) - (Cualesquiera cuatro letras o números)
Clasificación: Control de temperatura, Categoría de instalación II, Grado de contaminación 2
Tensión nominal: 100 a 240 V~ (CA) o 24 a 28 V ≈ (CA o CD)
Frecuencia nominal: 50 o 60 Hz
Consumo nominal de energía: 7 VA máximo

Cumple con los requisitos esenciales de las siguientes Directrices de la Unión Europea mediante el uso de las normas aplicables que se muestran a continuación para indicar su conformidad.

89/336/EEC Directriz de compatibilidad electromagnética

EN 61326:1997 CON A1:1998.- Equipo eléctrico para medición, control y uso en laboratorio - Requisitos EMC (Inmunidad industrial, Emisiones Clase A).

EN 61000-4-2:1996 con A1, 1998 - Inmunidad a descarga electrostática
EN 61000-4-3:1997 - Inmunidad a campo radiado
EN 61000-4-4:1995 - Inmunidad a incremento repentino/rápidas fluctuaciones eléctricas transitorias
EN 61000-4-5:1995 con A1, 1996 - Inmunidad a picos de voltaje o corriente
EN 61000-4-6:1996 - Inmunidad por conducción
EN 61000-4-11:1994 Inmunidad a caídas de voltaje, variaciones y pequeñas interrupciones de voltaje
EN 61000-3-2:1995 con A1-3:1999 - Emisiones de corriente armónica
EN 61000-3-3:1995 con A1:1998 - Fluctuaciones de voltaje y centelleo.

73/23/EEC Directriz de bajo voltaje

EN 61010-1:1993 con A1:1995 Requisitos de seguridad de equipo eléctrico para medición, control y uso en laboratorio. Parte 1: Requisitos generales

Jim Boigenzahn

Winona, Minnesota, USA

Name of Authorized Representative

Place of Issue

General Manager

September 2001

Title of Authorized Representative

Date of Issue

Signature of Authorized Representative

(2199)

Specifications

(2200)

Controller

- Microprocessor-based, user-selectable control modes
- Heat and cool auto-tune for control outputs
- Universal input 1, auxiliary input 2, 4 outputs
- Control outputs user-selectable as on/off, P, PI, PID
- Input sample period; Single input 10Hz (100 msec), dual input 5Hz (200 msec) adjustable digital filter
- Display update; 2Hz (500 msec), adjustable digital filter
- Retransmit output update; 1 Hz (1 second)
- Output update; burst, 0.1 to 999.9 seconds
- Input/Output/Communication isolation
- Displayed in °C, °F, or process units

Operator Interface

- Dual 4-digit LED displays: upper 0.4 in (10.2mm), lower 0.244 in (6.2mm)
- Advance, Up Arrow, Down Arrow, Infinity tactile keys

Standard Conditions For Specifications

- Ambient temperature 77°F/25°C ±3°C, rated line voltage, 50 to 60Hz, 0 to 90% RH non-condensing, 15-minute warm-up

Universal Input 1

Thermocouple

- Type J, K, T, N, C (W5), E, PTII, D (W3), B, R, S thermocouple types
- >20MΩ input impedance
- Maximum 20Ω source resistance
- 30μA open detection bias

RTD

- 2- or 3-wire platinum, 100Ω
- JIS and DIN curves
- Whole or tenth degree indication
- 150μA nominal RTD excitation current

Process

- Range selectable: 0-10V[≐] (dc), 0-5V[≐] (dc), 1-5V[≐] (dc), 0-20mA, 4-20mA,
- Voltage input impedance 20kΩ
- Current input impedance 100Ω
- Minimum current source resistance 1MΩ
- Input resolution 50,000 bits (approx.) at full scale
- mV input impedance 20MΩ

Input 2

Event Input

- Contact or voltage
- 20KΩ input impedance
- Voltage input: event high state 3 to 36V[≐] (dc), event low state 0 to 2V[≐] (dc)
- Resistance/contact input: event high state > 23kΩ, event low state 0 to 2kΩ

Remote Set Point Input: mA or DC Range Selectable

- Voltage input impedance 20kΩ
- Current input impedance 100Ω

Output Types

Open Collector/Switched DC

- Open collector configuration:
 - Maximum voltage 42V[≐] (dc)
 - Maximum current 200mA
 - Maximum “on” resistance 1.1Ω
 - Maximum offstate leakage current 100μA
- Switched dc configuration:
 - Switched dc supply voltage 22 to 28V[≐] (dc)
 - dc supply current limited to 30mA

Solid-state Relay

- Optically isolated
- Zero cross switched
- Without contact suppression
- Minimum load current 0.5mA rms
- Maximum current 0.5A rms at 20 to 280V~ (ac)
- Maximum offstate leakage current 10μA rms
- For resistive loads only, must use RC suppression for inductive loads

Electromechanical Relay

- Form C contact configuration
- Minimum load current 10mA @ 5V[≐] (dc)
- Rated resistive and inductive loads: 2A @ 250V~ (ac) or 30V[≐] (dc) maximum
- Electrical life 100,000 cycles at rated current
- For resistive loads only, must use RC suppression for inductive loads

Process

- Range selectable: 0-20mA, 4-20mA, 0-5V[≐] (dc), 1-5V[≐] (dc), 0-10V[≐] (dc)
- Reverse or direct acting
- 0 to 10V[≐] (dc) voltage output into 1,000Ω minimum load resistance
- 0 to 20mA current output into 800Ω maximum load resistance
- Resolution:
 - dc ranges = 2.5mV nominal
 - mA ranges = 5μA nominal
- Calibration accuracy:
 - dc ranges = ±15mV
 - mA ranges = ±30μA
- Temperature stability 100ppm/°C

Retransmit

- Range selectable: 0-20mA, 4-20mA, 0-5V[≐] (dc), 1-5V[≐] (dc), 0-10V[≐] (dc)
- 0 to 10V[≐] (dc) voltage output into a 1,000Ω minimum load resistance
- 0 to 20mA current output into an 800Ω maximum load resistance
- Resolution:
 - dc ranges = 2.5mV nominal
 - mA ranges = 5μA nominal
- Calibration accuracy:
 - dc ranges = ±15mV
 - mA ranges = ±30mA
- Temperature stability 100ppm/°C

Communications

- EIA/TIA-485 or EIA/TIA-232
- Opto-isolated
- Modbus™ RTU protocol
- 1200, 2400, 4800, 9600, 19200 baud rates
- 32 maximum units can be connected (with additional 485 repeater hardware, up to 247 units may be connected)

Accuracy

- Input ranges

Type J:	32 to 1382°F	or	0 to 750°C
Type K:	-328 to 2282°F	or	-200 to 1250°C
Type T:	-328 to 662°F	or	-200 to 350°C
Type N:	32 to 2282°F	or	0 to 1250°C
Type E:	-328 to 1470°F	or	-200 to 900°C
Type C(W5):	32 to 4200°F	or	0 to 2315°C
Type D(W3):	32 to 4200°F	or	0 to 2315°C
Type PTII:	32 to 2540°F	or	0 to 1393°C
Type R:	32 to 2642°F	or	0 to 1450°C
Type S:	32 to 2642°F	or	0 to 1450°C
Type B:	1598 to 3092°F	or	870 to 1700°C
DIN:	-328 to 1472°F	or	-200 to 800°C
JIS:	-328 to 1166°F	or	-200 to 630°C
Process:	-1999 to 9999 units		

Thermocouple Inputs

- Calibration accuracy $\pm 0.1\%$ of span $\pm 1^\circ\text{C}$ at standard conditions
 - Exceptions:
 - Type T; 0.12% of span for -200°C to -50°C ,
 - Types R and S; 0.15% of span for 0°C to 100°C
 - Types B; 0.24% of span for 870°C to 1700°C
- Accuracy span: 1,000°F/540°C minimum
- Temperature stability: ± 0.1 degree per degree change in ambient

RTD Inputs

- Calibration accuracy $\pm 0.1\%$ of span $\pm 1^\circ\text{C}$ at standard conditions
- Accuracy span: 1,000°F/540°C minimum
- Temperature stability: ± 0.05 degree per degree change in ambient

Process Inputs

- Voltage input ranges
 - Accuracy $\pm 10\text{mV} \pm 1$ LSD at standard conditions
 - Temperature stability $\pm 100\text{ppm}/^\circ\text{C}$ maximum
- Milliamp input ranges
 - Accuracy $\pm 20\mu\text{A} \pm 1$ LSD at standard conditions
 - Temperature stability $\pm 100\text{ppm}/^\circ\text{C}$ maximum

Agency Approvals

- UL 916 Listed file Number E185611; c-UL Approved,
- UL CCN QQXY, QQXY7 Process Control Equipment
- CE and NEMA 4X approved.

Modbus™ is a trademark of AEG Schneider Automation.
UL® is a registered trademark of the Underwriter's Laboratories, Inc.

Terminals

- Touch safe
- 22 to 12 AWG

Power

- 100-240V \approx (ac/dc) $+10\%$; -15% ; 50/60Hz, $\pm 5\%$
- 24-28V \approx (ac/dc) $+10\%$; -15% ; 50/60Hz, $\pm 5\%$
- 7.0VA maximum power consumption
- Data retention upon power failure via nonvolatile memory

Operating Environment

- 32 to 149°F, 0 to 65°C
- 0 to 90% RH, non-condensing
- Storage temperature: -40 to 185°F , -40 to 85°C

Dimensions

- Width 2.05 in. or 52mm
- Height 2.05 in. or 52mm
- Length 4.2 in. or 107mm
- Depth behind panel surface 3.875 in. or 98.4mm
- Approximate controller weight 0.4 lbs (0.2 kg)

Allowable Operating Ranges

Type J:	1.0	32	to	1,500°F	or	0	to	815°C
	0.1	32.0	to	999.9°F	or	0.0	to	815.0°C
Type K:	1.0	-454	to	2,500°F	or	-270	to	1,370°C
	0.1	-199.9	to	999.9°F	or	-199.9	to	999.9°C
Type T:	1.0	-454	to	750°F	or	-270	to	400°C
	0.1	-199.9	to	750.0°F	or	-199.9	to	400.0°C
Type N:	1.0	32	to	2,372°F	or	0	to	1,300°C
	0.1	32.0	to	999.9°F	or	0.0	to	999.9°C
Type E:	1.0	-454	to	1,470°F	or	-270	to	800°C
	0.1	-199.9	to	999.9°F	or	-199.9	to	800.0°C
Type C:	1.0	32	to	4,200°F	or	0	to	2,315°C
	0.1	32.0	to	999.9°F	or	0.0	to	999.9°C
Type D:	1.0	32	to	4,200°F	or	0	to	2,315°C
	0.1	32.0	to	999.9°F	or	0.0	to	999.9°C
Type PTII:	1.0	32	to	2,543°F	or	0	to	1,395°C
	0.1	32.0	to	999.9°F	or	0.0	to	999.9°C
Type R:	1.0	32	to	3,200°F	or	0	to	1,760°C
Type S:	1.0	32	to	3,200°F	or	0	to	1,760°C
Type B:	1.0	32	to	3,300°F	or	0	to	1,816°C
RTD (DIN)	1.0	-328	to	1,472°F	or	-200	to	800°C
	0.1	-199.9	to	999.9°F	or	-199.9	to	800.0°C
RTD (JIS)	1.0	-328	to	1,166°F	or	-200	to	630°C
	0.1	-199.9	to	999.9°F	or	-199.9	to	630.0°C
Process		-1,999	to	9,999 units				

Functionality Matrix

	Universal Input	Event & Remote Set Point	Control	Alarm	Retransmit	232/485 Comm
Input 1	■					
Input 2		■				
Output 1			■			
Output 2				■		
Output 3					■	
Output 4						■

Note: These specifications are subject to change without prior notice.

Ordering Information

(2201)

Series 96

9 6

Microprocessor-based
 1/16 DIN with universal input 1.
 Options include software, power
 supply, input 2, four outputs and
 display color

Power Supply

- A = 100-240V \approx (ac/dc)
- B = 24-28V \approx (ac/dc)

Input 2

- 0 = None
- 1 = Event input & 0-5V \approx (dc)/
4-20mA (remote set point
input)

Output 1

- C = Switched dc/open collector
- D = Electromechanical relay, Form C,
2A, without RC suppression
- F = Universal Process, range
selectable: 0-20mA, 4-20mA,
0-5V \approx (dc), 1-5V \approx (dc),
0-10V \approx (dc)
- K = 0.5A solid-state relay without
RC suppression

Output 2

- A = None
- C = Switched dc/open collector
- D = Electromechanical relay, Form C,
2A, without RC suppression
- F = Universal Process, range selectable:
0-20mA, 4-20mA, 0-5V \approx (dc),
1-5V \approx (dc), 0-10V \approx (dc)
- K = 0.5A solid-state relay without
RC suppression

Output 3

- A = None
- D = Electromechanical relay, Form C,
2A, without RC suppression

Output 4

- A = None
- D = Electromechanical relay, Form C,
2A, without RC suppression
- R = 232 Communications
- U = 485 Communications
- M = Universal Retransmit, range selectable: 0-20mA,
4-20mA, 0-5V \approx (dc), 1-5V \approx (dc),
0-10V \approx (dc)

Software/Preset Parameters

- 00 = Standard software
- AA = Ramping
- XX = Custom software
- XX = Preset parameters

Standard Display/Overlay

- | | Upper
Display | Lower
Display |
|----|------------------|------------------|
| RR | Red | Red |
| RG | Red | Green |
| GR | Green | Red |
| GG | Green | Green |

Ramping Display/Overlay

- | | Upper
Display | Lower
Display |
|----|------------------|------------------|
| BA | Red | Red |
| BB | Red | Green |
| BC | Green | Red |
| BD | Green | Green |

Index

A

- Abort Set Point 6.11
- Address 6.16
- Alarm 2 High 6.6
- Alarm 2 Low 6.6
- Alarm 2 Type 6.11
- Alarm 3 High 6.7
- Alarm 3 Low 6.6
- Alarm 3 Type 6.13
- Alarm 4 High 6.7
- Alarm 4 Low 6.7
- Alarm 4 Type 6.14
- Alarm
 - latching 5.9, 6.12, 6.13, 6.14
 - process or deviation 5.9
 - silencing 5.10
- Alarm Active Sides 2 6.12
- Alarm Active Sides 3 6.13
- Alarm Active Sides 4 6.15
- Alarm Annunciation 2 6.12
- Alarm Annunciation 3 6.14
- Alarm Annunciation 4 6.15
- Alarm Hysteresis 2 6.12
- Alarm Hysteresis 3 6.13
- Alarm Hysteresis 4 6.14
- Alarm Hysteresis 5.9
- Alarm Logic 2 6.12
- Alarm Logic 3 6.14
- Alarm Logic 4 6.15
- Alarm Menu 6.6-6.7
- Alarm Set Points 5.9
- Ambient A-D Counts 6.22
- Ambient Temperature 6.22
- Analog Output 4 6.15
- Analog Output High 6.15
- Analog Output Low 6.15
- Analog Output Offset 6.16
- Auto-Manual Operation Mode 6.2
- Auto-tune Set Point 5.2, 6.3
- Auto-tune 5.2, 6.2

B

- Baud Rate 6.16
- Bumpless transfer 5.11
- Burst 1 6.4
- Burst 2 6.5
- Burst Fire 5.8

C

- Calibration 1 Menu 6.22
- Calibration Menu Lock 6.20
- Calibration Offset 2 6.10
- Calibration Offset 5.3, 6.3
- Channel 1 A-D Counts 6.22
- Channel 2 A-D Counts 6.22
- configure the controller 4.4
- communications 5.11
 - and retransmit options 3.7
- °C or °F 6.16
- Custom Menu 4.3, 5.1, 6.18-6.19
- Custom Menu Lock 6.19
- Custom Prompt number 6.18-6.19
- Cycle Time 1 6.4
- Cycle Time 2 6.5

D

- Date of Manufacture 6.20
- Dead Band 1 6.4
- Dead Band 2 6.6
- Dead Band 5.7
- Decimal 1 6.9
- Derivative 1 6.4
- Derivative 2 6.5
- Diagnostics Menu 6.20-6.22
- digital event
 - wiring 3.3

E

- End Step Menu 7.4
- End 7.4
- Errors
 - bumpless transfer 5.11
 - open loop detect 5.10
 - troubleshooting A.2-A.3
- Event Condition 6.11
- Event Function 6.10
- Event Input 5.4, 7.6
- Event Input Status 6.2
- Event Outputs 7.1
- Event Outputs 7.2, 7.3
- Event Set Point 6.3

F

- Factory Page 4.2, 4.3, 6.18-6.22
- Failure Mode 5.11, 6.16
- feedback inside front cover
- File 7.1
- filter time constant 5.3

G

- gap dimensions 2.1
- Global Menu 6.16-6.17

H

- High Power Limit Above 6.17
- High Power Limit Below 6.17
- High Resolution 6.21
- Home Page 4.2, 4.3, 6.1
- Hour 7.2, 7.3
- Hysteresis 1 6.4
- Hysteresis 2 6.6

I J

- Input 1 6.8
- Input 2 6.9
 - Hardware Enabled 6.21
- Input 1 Menu 6.8-6.9
- Input 2 Menu 6.9-6.11
- Input Error Latching 6.16
- inputs and outputs (graphic) 1.1
- Input Software Filter 1 6.9
- input-to-output isolation 3.1
- input wiring 3.2-3.3
 - digital event 3.3
 - process 3.2, 3.3
 - RTD 3.2
 - thermocouple 3.2
- installation 2.1-2.2
 - sensor 3.1
- Integral 1 6.3
- Integral 2 6.5
- Isolation blocks 3.1
- Jump Count 7.4
- Jump File 7.4
- Jump-loops 7.6
- Jump Loop Menu 7.4
- Jump Step 7.4

K

- keys and displays 4.1

L

- Latching 2 6.12
- Latching 3 6.13
- Latching 4 6.14
- Line Frequency 6.22
- Local or Remote Mode 6.3
- Lockout Menu 6.19-6.20

M

- Manual Default Power 6.16
- Minutes 7.2, 7.3
- Model Number 6.20
- Monitor Menu 6.2

N

Navigation and Software 4.1-4.4
Raming menu 7.4

O

On/Off control 5.5
Open Loop Detect 5.10, 6.17
Operations Page 4.2, 4.3, 6.2-6.7
Operations Page Mode lockout 6.19
Output 1 6.11
Output 2 6.11
Output 3 6.13
Output 4 6.14
Output 1 Hardware 6.21
Output 2 Hardware 6.21
Output 3 Hardware 6.21
Output 4 Hardware 6.21
Output 1 Menu 6.11
Output 2 Menu 6.11-6.13
Output 3 Menu 6.13-6.14
Output 4 Menu 6.14-6.16
output wiring 3.4-3.7
AC 3.4-3.7
communications and retransmit 3.7
process 3.4, 3.5
switched DC, open collector 3.4, 3.5

P Q

panel cutout dimensions 2.1
Percent Output 6.2
PID 1 Menu 6.3-6.4
PID 2 Menu 6.5-6.6
Power Limit 5.2
Power Limit Set Point 6.17
power wiring 3.1
Process 2 6.2
Process 1 Type 6.11
Process 2 Type 6.11
Process 4 Type 6.15
process input wiring 3.2, 3.3
process output wiring 3.4, 3.5
Profiles
Menus 7.5
Resume 7.5
Running 7.5
Program Lock 6.20
Program Type 6.17
Propband 1 6.3
Propband 2 6.5

Proportional Control 5.6
Proportional plus Integral (PI) Control 5.6
Proportional plus Integral plus Derivative (PID) Control 5.7
Dual 5.7

R

Ramping Mode 6.17
Ramping Set Point 6.2
Ramp Scale 6.17
Ramp Rate 6.17
Range Low and Range High 5.4
Range High 1 6.9
Range High 2 6.10
Range Low 1 6.9
Range Low 2 6.10
Rate 7.2
Rate 1 6.4
Rate 2 6.5
remote set point retransmitting 5.5
removing controller 2.2
Reset 1 6.3
Reset 2 6.5
Restore Factory Calibration 6.22
RTD input wiring 3.2

S

safety information inside front cover
Seconds 7.2, 7.3
sensor
installation 3.1
selection 5.3
Sensor Type 1 6.8
Serial Number 1 6.20
Serial Number 2 6.20
Set Point 7.2
Lock 6.19
ramping to 5.8
Set Point 2 6.3, 7.3
Set Point Step 7.2
Setup Page 4.2, 4.3, 6.8-6.17
Setup Page Lock 6.20
Silencing 2 6.12
Silencing 3 6.13
Silencing 4 6.15
Soak Step 7.3
Soak Step Wait-for Functions 7.6
Software ID Number 6.20
software map 4.3
Software Revision 6.21
Step 7.1
Step Type 7.1

T

tasks 4.4
technical assistance inside front cover
Test Display 6.21
Test Output 6.21
thermocouple inputs wiring 3.2
Troubleshooting 6.22
Troubleshooting Alarms and Errors A.1-A.2

UV

Units Type 6.16
User Menu 6.2-6.3

WXYZ

Wait-for Deviation Value 7.3
Wait-for Event Input 7.3
warranty information back cover
wiring 3.1-3.9
Input 1 3.2
Input 2 3.3
Output 1 3.4
Output 2 3.5
Output 3 3.6
Output 4 3.7
wiring example 3.9

Prompt Index

1 1	Output Calibration 1, 1V
1 4	Output Calibration 1, 4mA
1 10	Output Calibration 1, 10V
1 20	Output Calibration 1, 20mA
2 1	Output Calibration 2, 1V
2 4	Output Calibration 2, 4mA
2 10	Output Calibration 2, 10V
2 20	Output Calibration 2, 20mA
4 1	Output Calibration 4, 1V
4 4	Output Calibration 4, 4mA
4 10	Output Calibration 4, 10V
4 20	Output Calibration 4, 20mA

A	
A 0v	Process Calibration 1, 0V
A 2h	Alarm 2 High 6.6
A 2Lo	Alarm 2 Low 6.6
A 3h	Alarm 3 High 6.7
A 3Lo	Alarm 3 Low 6.6
A 4A	Process Calibration 1, 4mA
A 4h	Alarm 4 High 6.7
A 4Lo	Alarm 4 Low 6.7
A 10v	Process Calibration 1, 10V
A 20A	Process Calibration 1, 20mA
A CAL	Analog Output Offset 6.16
A cnt	Ambient A-D Counts 6.22
A ddr	Address 6.16
A h	Analog Output High 6.15
A h y 2	Alarm Hysteresis 2 6.12
A h y 3	Alarm Hysteresis 3 6.13
A h y 4	Alarm Hysteresis 4 6.14
A L n	Alarm Menu 6.6-6.7
A Lo	Analog Output Low 6.15
A - n	Auto-Manual Operation Mode 6.2
A n b	Ambient Temperature 6.22
A n u 2	Alarm Annunciation 2 6.12
A n u 3	Alarm Annunciation 3 6.14
A n u 4	Alarm Annunciation 4 6.15
A o u t	Analog Output 4 6.15
A t S P	Auto-tune Set Point 6.3
A t y 2	Alarm 2 Type 6.11
A t y 3	Alarm 3 Type 6.13
A t y 4	Alarm 4 Type 6.14
A u t	Auto-tune 6.2
A b S P	Abort Set Point 6.11

B	
b 0v	Process Calibration 2, 0V
b 4A	Process Calibration 2, 4mA
b 10v	Process Calibration 2, 10V
b 20A	Process Calibration 2, 20mA
b R U d	Baud Rate 6.16
b r S 1	Burst 1 6.4
b r S 2	Burst 2 6.5

C	
C AL	Calibration Menu Lock 6.20
C AL 1	Calibration Offset 6.3
C AL 2	Calibration Offset 2 6.10
C i n 1	Calibration 1 Menu 6.22
C i n 2	Calibration 2 Menu
C - F	°C or °F 6.16
C n t 1	Channel 1 A-D Counts 6.22
C n t 2	Channel 2 A-D Counts 6.22
C o u t	Process Output Calibration Menu
C t 1	Cycle Time 1 6.4
C t 2	Cycle Time 2 6.5
C U S E	Custom Menu 6.18-6.19
C U S L	Custom Menu Lock 6.19

NOTE: Complete information on calibration prompts are explained at Watlow's web site, <http://www.watlow.com/literature/prodtechinfo>. Search on 96 calibration manual.

D	
d A E E	Date of Manufacture 6.20
d b 1	Dead Band 1 6.4
d b 2	Dead Band 2 6.6
d E 1	Derivative 1 6.4
d E 2	Derivative 2 6.5
d E C 1	Decimal 1 6.9
d F L E	Default Settings 6.22
d I R 9	Diagnostics Menu 6.20-6.22
d , S P	Test Display 6.21

E	
E c n	Event Condition 6.11
E F n	Event Function 6.10
E r r	Input Error Latching 6.16
E n d	End Step Menu 7.4
E n d	End 7.4
E S P	Event Set Point 6.3
E S E	Event Input Status 6.2
E o u t	Event Outputs 7.1
E o u t	Event Outputs 7.2, 7.3

F	
F A I L	Failure Mode 6.16
F . I L	File 7.1
F c t y	Factory Page menus 6.18-6.22
F t e r	Input Software Filter 1 6.9

G	
g l b l	Global Menu 6.16-6.17
g n d	Set Ground

H	
H o u r	Hour 7.2, 7.3
h r e s	High Resolution 6.21
h y S 1	Hysteresis 1 6.4
h y S 2	Hysteresis 2 6.6

I J K	
I n 1	Input 1 6.8
I n 2	Input 2 6.9
I n P 1	Input 1 Menu 6.8-6.9
I n P 2	Input 2 Menu 6.9-6.11
I t 1	Integral 1 6.3
I t 2	Integral 2 6.5
I E Y 2	Input 2 Hardware Enabled 6.21
J C	Jump Count 7.4
J F	Jump File 7.4
J L	Jump Loop Menu 7.4
J S	Jump Step 7.4

L	
L 9 c 2	Alarm Logic 2 6.12
L 9 c 3	Alarm Logic 3 6.14
L 9 c 4	Alarm Logic 4 6.15
L A E 2	Latching 2 6.12
L A E 3	Latching 3 6.13
L A E 4	Latching 4 6.14
L E R d	Lead Resistance Calibration
L i n E	Line Frequency 6.22
L O C	Lockout Menu 6.19-6.20
L - r	Local or Remote Mode 6.3

M N	
M n A n	Manual Default Power 6.16
M n d L	Model Number 6.20
M n i n	Minutes 7.2, 7.3
M n o n	Monitor Menu 6.2

O	
O P E r	Operations Page menus 6.2-6.7
O P E r	Operations Page Mode Lock 6.19
O P L P	Open Loop Detect 6.17
O E Y 1	Output 1 Hardware 6.21
O E Y 2	Output 2 Hardware 6.21
O E Y 3	Output 3 Hardware 6.21
O E Y 4	Output 4 Hardware 6.21
O t 1	Output 1 6.11
O t 2	Output 2 6.11
O t 3	Output 3 6.13

O t 4	Output 4 6.14
O u t 1	Output 1 Menu 6.11
O u t 2	Output 2 Menu 6.11-6.12
O u t 3	Output 3 Menu 6.13-6.14
O u t 4	Output 4 Menu 6.14-6.16

P Q	
P 1	to P 16 Custom Prompt number (1-16) 6.18-6.19
P b 1	Propband 1 6.3
P b 2	Propband 2 6.5
P c n t	Percent Output 6.2
P , i d 1	PID 1 Menu 6.3-6.4
P , i d 2	PID 2 Menu 6.5-6.6
P L S P	Power Limit Set Point 6.17
P L A	High Power Limit Above 6.17
P L b	High Power Limit Below 6.17
P r 2	Process 2 6.2
P r c 1	Process 1 Type 6.11
P r c 2	Process 2 Type 6.11
P r c 4	Process 4 Type 6.15
P E Y P	Program Type 6.17
P r O g	Program Lock 6.20

R	
r 15	RTD Calibration, 15Ω
r 380	RTD Calibration, 380Ω
r A E E	Rate 7.2
r A E E	Ramp Rate 6.17
r A 1	Rate 1 6.4
r A 2	Rate 2 6.5
r E 1	Reset 1 6.3
r E 2	Reset 2 6.5
r E v	Software Revision 6.21
r h 1	Range High 1 6.9
r h 2	Range High 2 6.10
r L 1	Range Low 1 6.9
r L 2	Range Low 2 6.10
r P	Ramping Mode 6.17
r P S	Ramp Scale 6.17
r P S P	Ramping Set Point 6.2
r S E	Restore Factory Calibration 6.22

S	
S E C	Seconds 7.2, 7.3
S E n 1	Sensor Type 1 6.8
S E E	Setup Page menus 6.8-6.17
S E E	Setup Page Lock 6.20
S , i d 2	Alarm Active Sides 2 6.12
S , i d 3	Alarm Active Sides 3 6.13
S , i d 4	Alarm Active Sides 4 6.15
S i L 2	Silencing 2 6.12
S i L 3	Silencing 3 6.13
S i L 4	Silencing 4 6.15
S n 1	Serial Number 1 6.20
S n 2	Serial Number 2 6.20
S o A H	Soak Step menu 7.3
S o F E	Software ID Number 6.20
S P 2	Set Point 2 6.3
S P	Set Point Lock 6.19
S P	Set Point 7.2
S P	Step 7.1
S E E P	Set Point Step menu 7.2
S E Y P	Step Type 7.1

T	
T c 00	Thermocouple Calibration, 0mV
T c 32	Thermocouple Calibration, 32mV
T c 50	Thermocouple Calibration, 50mV
T o u t	Test Output 6.21
T S H E	Troubleshooting 6.22
U V W X Y Z	
U n i t	Units Type 6.16
U S E r	User Menu 6.2-6.3
W d E	Wait-for Deviation Value 7.3
W E	Wait-for Event Input 7.3

Series 96 Software Map

Home Page

- 96** Process 1 Value
- 96** Set Point Value, Remote Set Point Value or Percent Output Value
- 96** Custom Menu**...
- P1**

Program Menu*

(see pg. 7.1)

Operations Page

- P700** Monitor Menu
- OPER** Operations Page
- Pr2** Process 2**
- Pcnt** Percent Output
- rPSP** Ramping Set Point**
- E 5E** Event Input Status

USER User Menu

- OPER** Operations Page
- A-P7** Auto-Manual Operations Mode**
- Aut** Auto-tune
- RESP** Auto-tune Set Point
- SP2** Set Point 2**
- E 5P** Event Set Point**
- L-r** Local or Remote Mode**
- CAL** Calibration Offset

P1d1 PID 1 Menu

- OPER** Operations Page
- Pb 1** Propband 1
- IE 1** Integral 1
- RE 1** Reset 1
- DE 1** Derivative 1
- rR 1** Rate 1
- brs 1** Burst 1
- CE 1** Cycle Time 1
- hys 1** Hysteresis 1
- db 1** Dead Band 1

P1d2 PID 2 Menu

- OPER** Operations Page
- Pb 2** Propband 2
- IE 2** Integral 2
- RE 2** Reset 2
- DE 2** Derivative 2
- rR 2** Rate 2
- brs 2** Burst 2
- CE 2** Cycle Time 2
- hys 2** Hysteresis 2
- db 2** Dead Band 2

RLP7 Alarm Menu

- OPER** Operations Page
- R2Lo** Alarm 2 Low
- R2Hi** Alarm 2 High
- R3Lo** Alarm 3 Low
- R3Hi** Alarm 3 High
- R4Lo** Alarm 4 Low
- R4Hi** Alarm 4 High

Setup Page

- INP1** Input 1 Menu
- SEE** Setup Page
- SEN1** Sensor Type
- IN1** Input Type 1
- rL1** Range Low 1
- rH1** Range High 1
- dEC1** Decimal 1
- Fcr1** Input Software Filter 1

INP2 Input 2 Menu

- SEE** Setup Page
- IN2** Input 2**
- rL2** Range Low 2**
- rH2** Range High 2**
- CAL2** Calibration Offset 2**
- E Fn** Event Function
- E cn** Event Condition
- Rb5P** Abort Set Point*

OUT1 Output 1 Menu

- SEE** Setup Page
- OE 1** Output 1
- Prct1** Process Type 1

OUT2 Output 2 Menu

- SEE** Setup Page
- OE 2** Output 2
- Prct2** Process Type 2
- REY2** Alarm Type 2
- RHY2** Alarm Hysteresis 2
- LRE2** Latching 2
- SIL2** Silencing 2
- S id2** Alarm Active Sides 2
- L9c2** Alarm Logic 2
- Rnu2** Alarm Annunciation 2

OUT3 Output 3 Menu

- SEE** Setup Page
- OE 3** Output 3
- REY3** Alarm Type 3
- RHY3** Alarm Hysteresis 3
- LRE3** Latching 3
- SIL3** Silencing 3
- S id3** Alarm Active Sides 3
- L9c3** Alarm Logic 3
- Rnu3** Alarm Annunciation 3

OUT4 Output 4 Menu

- SEE** Setup Page
- OE 4** Output 4
- REY4** Alarm Type 4
- RHY4** Alarm Hysteresis 4
- LRE4** Latching 4
- SIL4** Silencing 4
- S id4** Alarm Active Sides 4
- L9c4** Alarm Logic 4
- Rnu4** Alarm Annunciation 4
- RouE** Analog Output 4
- Prct4** Process Type 4
- R h** Analog Output High
- R Lo** Analog Output Low
- R CAL** Analog Output Offset
- BRUD** Baud Rate
- Raddr** Address

9LbL Global Menu

- SEE** Setup Page
- Units** Units Type
- C-F** C or F
- Err** Input Error Latching
- FRIL** Failure Mode**
- P7Rn** Manual Default Power**
- PLSP** Power Limit Set Point
- PL A** High Power Limit Above
- PL b** High Power Limit Below
- rP** Ramping Mode**
- rP S** Ramp Scale**
- rRE** Ramp Rate**
- OPLP** Open Loop Detect
- PtYP** Program Type*

Factory Page

- CUSE** Custom Menu**
- FctY** Factory Page
- P1**
- P2**
- P3**
- P4**
- P5**
- P6**
- P7**
- P8**
- P9**
- P10**
- P11**
- P12**
- P13**
- P14**
- P15**
- P16**

LOC Lockout Menu

- FctY** Factory Page
- SP** Set Point Lock
- Pr09** Program Menu Lock*
- CUSE** Custom Menu Lock**
- OPER** Operations Page Mode
- SEE** Setup Page Lock
- CAL** Calibration Menu Lock

d1R9 Diagnostics Menu

- FctY** Factory Page
- P7dL** Model Number
- dRE** Date of Manufacture
- S n1** Serial Number 1
- S n2** Serial Number 2
- SofE** Software ID Number
- IEY2** Input Type 2
- rEv** Software Revision
- OEY1** Output 1 Hardware
- OEY2** Output 2 Hardware
- OEY3** Output 3 Hardware
- OEY4** Output 4 Hardware
- EOU** Test Output
- d1SP** Test Displays
- hrES** High Resolution
- RP7b** Ambient Temperature
- Rcnt** Ambient A-D Counts
- cnt 1** Channel 1 A-D Counts
- cnt 2** Channel 2 A-D Counts
- ESht** Communications Test/Troubleshooting
- Line** Line Frequency

The Factory Page also includes calibration parameters that are not necessary for everyday use of the controller. Calibration parameters and procedures are explained at Watlow's web site, <http://www.watlow.com/literature/prodtechinfo>. Search on **96 calibration manual**.

*Menu added if ramping version of the controller is selected (96 - -AA).

**Menu removed if ramping version of the controller is selected (96 - -AA).

Enter your settings on a photocopy of this page.

Table 3.2 — Set up parameters in this order.

Key:
D = Changing will change the default
C = Changing will convert the temperature scale
0 = Other effect

	Units Type <u>Un i E</u>	°C or °F <u>C-F</u>	Output 1 <u>DE 1</u>	Output 2 <u>DE 2</u>	Sensor Type <u>SEn 1</u>	Input 1 <u>In 1</u>	Range High 1 <u>rh 1</u>	Range Low <u>rl 1</u>	Decimal 1 <u>DEC 1</u>	HPL Above <u>PL a</u>	HPL Below <u>PL b</u>	Input 2 <u>In 2</u>	Alarm Type 2, 3, 4
Units Type <u>Un i E</u>													
°C or °F <u>C-F</u>													
Failure Mode <u>FR i L</u>													
Output 1 <u>DE 1</u>													
Output 2 <u>DE 2</u>													
Output 3 <u>DE 3</u>													
Output 4 <u>DE 4</u>													
Manual Default Power <u>P7Rn</u>			0	0						0	0		
Sensor Type <u>SEn 1</u>													
Input 1 <u>In 1</u>					0								
Range High 1 <u>rh 1</u>		C			D	D			C				
Range Low <u>rl 1</u>		C			D	D			C				
Decimal 1 <u>DEC 1</u>					D	D							
Calibration Offset 1 <u>CAL 1</u>		C			D	D			C				
Input Software Filter 1 <u>FEr 1</u>					D	D			0				
Power Limit Set Point <u>PLSP</u>		C			D	D	0	0	C				
High Power Limit Above <u>PL a</u>			0	0									
High Power Limit Below <u>PL b</u>			0	0									
Input 2 <u>In 2</u>													
Event Function <u>EFn</u>													0
Event Condition <u>ECn</u>													0
Range High 2 <u>rh 2</u>		C							C				D
Range Low 2 <u>rl 2</u>		C							C				D
Calibration Offset 2 <u>CAL 2</u>		C							C				D
Analog Output 4 <u>ROUT</u>					D	D							
Analog Output High <u>A h i</u>		C			D	D			C				
Analog Output Low <u>A Lo</u>		C			D	D			C				
Analog Output Offset <u>ACAL</u>		C			D	D			C				
Ramping Mode <u>rP</u>													
Ramp Scale <u>rP S</u>													
Ramp Rate <u>rP EE</u>													
Alarm Type 2, 3, 4 <u>AEY2 3 4</u>													
Alarm Hysteresis 2, 3, 4 <u>AhY2 3 4</u>		C			D	D			C				
Latching 2, 3, 4 <u>LAEL 3 4</u>													
Alarm Silencing 2, 3, 4 <u>SL2 3 4</u>													
Alarm Active Sides 2, 3, 4 <u>Sid2 3 4</u>													
Alarm Logic 2, 3, 4 <u>LG2 3 4</u>													
Alarm 2, 3, 4 High <u>A2h i 3 4</u>		C			D	D			C				0
Alarm 2, 3, 4 Low <u>A2Lo 3 4</u>		C			D	D			C				0
Propband 1, 2 <u>Pb 1 2</u>		C			D	D			C				
Integral 1, 2 <u>IE 1 2</u>		C											
Reset 1, 2 <u>RE 1 2</u>		C											
Derivative 1, 2 <u>DE 1 2</u>													
Rate 1, 2 <u>RA 1 2</u>													
Burst 1, 2 <u>BS 1 2</u>													
Cycle Time 1, 2 <u>CT 1 2</u>													
Dead Band 1, 2 <u>db 1 2</u>		C			D	D			C				
Hysteresis 1, 2 <u>HYS 1 2</u>		C			D	D			C				
Auto-Manual Operations Mode <u>A-Pn</u>													
Event Set Point <u>E SP</u>		C			D	D	0	0	C				
Set Point 2 <u>SP2</u>		C			D	D	0	0	C				
Set Point Lock <u>SP</u>		C			D	D	0	0	C				
Manual Set Point		0	0						0	0			

Changing this Affects this →

How to Reach Us



Quality and Mission Statement:

Watlow Winona will be the world's best supplier of industrial temperature control products, services, and systems by exceeding our customers', employees', and shareholders' expectations.

Contact

Your Authorized Watlow Distributor is:

- Phone: (507) 454-5300.
- Fax: (507) 452-4507.
- For technical support, ask for an Applications Engineer.
- To place an order, ask for Customer Service.
- To discuss a custom option, ask for a Series 96 Product Manager.

Warranty

The Watlow Series 96 is warranted to be free of defects in material and workmanship for 36 months after delivery to the first purchaser for use, providing that the units have not been misapplied. Since Watlow has no control over their use, and sometimes misuse, we cannot guarantee against failure. Watlow's obligations hereunder, at Watlow's option, are limited to replacement, repair or refund of purchase price, and parts which upon examination prove to be defective within the warranty period specified. This warranty does not apply to damage resulting from transportation, alteration, misuse, or abuse.

Returns

- Call or fax Customer Service for a Return Material Authorization (RMA) number before returning a controller.
- Put the RMA number on the shipping label, and also on a written description of the problem.
- A restocking charge of 20% of the net price is charged for all standard units returned to stock.

Watlow Series 96 User's Manual

Watlow Winona, 1241 Bundy Blvd., P.O. Box 5580, Winona, MN USA 55987-5580,
Phone: (507) 454-5300, Fax: (507) 452-4507