

Dear Customer,

Thank you for choosing a HANNA instruments® product.

Please read this instruction manual carefully before using the instrument.

It will provide you with the necessary information for correct use of the instrument, as well as a precise idea of its versatility.

If you need additional technical information, do not hesitate to e-mail us at tech@hannainst.com or see the back cover for our worldwide contact list.

This instrument is in compliance with the **CE** directives.

HANNA instruments® reserves the right to modify the design,
construction and appearance of its products without advance notice.

TABLE OF CONTENTS

CHAPTER 1- INTRODUCTION

1.1 Preliminary Examination	7
1.2 Model Identification	7
1.3 General Description	8
1.4 Power Supply	10
1.4.1 Battery Installation	10
1.4.2 Charging Batteries	10
1.5 Probe Description & Installation	11
1.5.1 Sensor Description	11
1.5.2 Specifications of Sensors	12
1.5.3 DO Sensor Activation	13
1.5.4 Installation	13
1.6 Specifications	14
1.7 Display & Keyboard Description	18
1.8 Help function	19

CHAPTER 2 - MEASUREMENT MODE

CHAPTER 3 - SETUP MODE

3.1 Measurement Setup	21
3.2 System Setup	23
3.3 Table of Measurement & Setup Items	27

CHAPTER 4 - CALIBRATION MODE

4.1 Quick Calibration	29
4.2 pH Calibration	31
4.2.1 Preparation	31
4.2.2 Procedure	31
4.2.3 Error List	33
4.3 Dissolved Oxygen Calibration	34
4.4 Conductivity Calibration	35
4.5 Atmospheric Pressure Calibration	38

4.6 ORP Calibration	38
4.7 Temperature Calibration	39

CHAPTER 5 - GPS MENU (optional)

CHAPTER 6 - LOGGING MODE

6.1 Logging	43
6.1.1 Logging Options	43
6.2 Log Data Setup	45
6.2.1 Lots	45
6.2.2 Delete All Lots	46
6.2.3 Remarks	47
6.2.4 Delete All Remarks	47
6.2.5 Tags	47

CHAPTER 7 - GLP DATA

7.1 Probe Information	50
7.2 pH	51
7.3 Dissolved Oxygen	51
7.4 Conductivity	52
7.5 Atmospheric Pressure	52
7.6 ORP	53
7.7 Temperature	53

CHAPTER 8 - PC CONNECTION

8.1 Software Installation	54
8.2 PC Connection	54

CHAPTER 9 - ERROR MESSAGES

APPENDIX

A - PROBE MAINTENANCE	59
B - ACCESSORIES	61
C - WARRANTY	63

Chapter 1 - INTRODUCTION

1.1 PRELIMINARY EXAMINATION

Remove the instrument from the packing material and examine it carefully to make sure that no damage has occurred during shipping. If there is any noticeable damage, notify your Dealer or the nearest HANNA Customer Service Center immediately.

HI9828 is supplied complete with:

- Multisensor probe (pH/ORP, Conductivity, DO, temperature)
- HI9828-25 quick calibration standard solution, 500 mL
- Calibration beaker
- Probe maintenance kit
- 4 rechargeable C size, Ni-MH batteries
- Power adaptor and cable
- Cigarette lighter cable
- 5 iButton® with holder
- HI7698281 USB interface cable
- HI929828 Windows® compatible software
- Instruction manual
- Rugged carrying case

Note Save all packing materials until you are sure that the instrument functions correctly. Any damaged or defective items must be returned in their original packing materials together with the supplied accessories.

1.2 MODEL IDENTIFICATION

Different models are available according to the following scheme:

HI 9828 xy

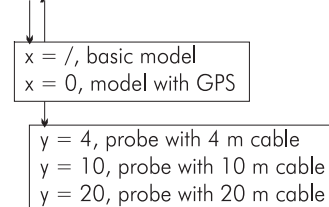

Note: Probes with different cable length are available upon request.

1.3 GENERAL DESCRIPTION

HI9828 is a multiparameter system that monitors up to 13 different water quality parameters (6 measured, 7 calculated).

The microprocessor based multisensor probe allows to measure all the parameters necessary to evaluate the water quality, as dissolved oxygen saturation percentage, conductivity, seawater specific gravity and other parameters that ensure life in water as pH and temperature. The same probe can be used with different meters without needing any recalibration.

HI9828 is also provided with a built-in 12 channel GPS receiver and antenna, that guarantee a position accuracy of 10 m (30 ft).

Measurements from specific locations are tracked with detailed coordinate information that can be viewed immediately on the display.

GPS information can be transferred to a PC using HANNA's **HI929828** software. GPS information can also be viewed using a GPS mapping software such as Google™ Maps. Clicking on visited locations using a mapping software such as Google™ Maps displays measurement information.

For measuring points within a 10 meter range or where GPS signal is not available, **HI9828**'s Fast Tracker™ is invaluable for associating measurements with their locations. HANNA's exclusive Fast Tracker™—T.I.S. (Tag ID System) monitors and records data using iButton®s that can be installed at any number of sampling sites.

HI9828 features a graphic, backlit display that automatically sizes the digits to fit the screen and allows full configuration of each parameter measured along with on-screen graphing capability.

Designed for outdoor environments, waterproof, resistant and easy to use, **HI9828** is the ideal solution for field measurements of lakes, rivers and sea.

The meter meets IP67 standards (30 minutes immersion under 1 m of water); the multi sensor probe can be left underwater (IP68 standard).

The setting menu can be protected by password to avoid not authorized modifications and the help function is always available to explain the selected function, operation or message.

Main features of the **HI 9828** system:

- Simultaneously displaying of up to 12 parameters
- Tracking of measurement locations with GPS (optional)
- IP67 waterproof protection for meter and IP68 for probe
- Exclusive Fast Tracker™—T.I.S. (Tag ID System)
- Graphic LCD with backlight
- Built-in barometer for DO compensation
- Quick Calibration feature
- Measurement check to eliminate any erroneous readings
- Auto recognition of pH and pH/ORP probe
- Logger function to record the data of all connected sensors
- Log-on-demand and automatic logging (up to 60,000 samples)
- Logged data can be displayed as graphs
- USB interface for PC communication
- Auto-range of EC and TDS readings
- Good Laboratory Practice feature with recording of last 5 calibrations
- Field replaceable sensors
- Meter can be powered with both alkaline and rechargeable batteries

1.4 POWER SUPPLY

HI9828 is supplied with 4 rechargeable C size, Ni-MH batteries.

The battery symbol on the LCD shows the remaining battery charge. When the symbol starts blinking, batteries should be charged or replaced with new ones. When the batteries are completely rundown the meter automatically shuts off to avoid erroneous readings.

1.4.1 Battery Installation

Battery replacement must only take place in a nonhazardous area.

Remove the 4 screws on the rear of the instrument and insert the batteries while paying attention to the correct polarity.

If using rechargeable batteries, move the switch down toward the probe connector. Move the switch upward for not rechargeable alkaline batteries.

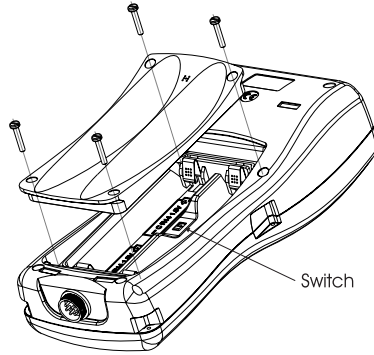

Not rechargeable batteries can explode or leak if attempting to charge them with the switch set to down position.

1.4.2 Charging Batteries

HI9828 is supplied with two cables for charging batteries: HI710045 and HI710046.

Mains power supply

In order to charge batteries from the mains, use the HI710045 cable and the supplied 12 Vdc adapter.

- With the meter OFF, disconnect the probe.
- Connect the HI710045 to meter connector and power adapter, then connect the adapter to the mains.
- The message “Battery charging in progress” will appear on the LCD, followed by the battery symbol.
- A complete battery charging will last about 14 hours.



Cigarette lighter supply

To charge batteries from a vehicle cigarette lighter supply, use HI710046 cable.

- Simply connect the cable to the meter and to the cigarette lighter plug.
- The message “Battery charging in progress” will appear on the display, followed by the battery symbol.
- A complete battery charging will last about 14 hours.

Note Batteries can also be charged with the meter ON; if the auto-off feature is enabled, the meter turns off automatically after the set time.

1.5 PROBE DESCRIPTION & INSTALLATION

HI9828 is supplied with a multisensor probe for dissolved oxygen, temperature, conductivity, pH and redox measurements.

1.5.1 Sensor Description

The galvanic DO sensor allows to obtain stable readings in a few seconds. The thin permeable membrane isolates the sensor elements from the testing solution, but allows oxygen to enter. Oxygen that passes through the membrane causes a current flow, from which the oxygen concentration is determined. Before installing the probe, it is necessary to activate the DO sensor; see paragraph 1.5.3 for details.

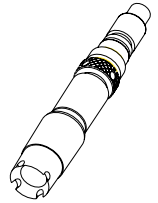

The conductivity sensor uses the 4-ring technology that allows stable and linear readings without any interference in the whole range.

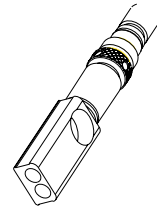

The pH/ORP sensor features a glass membrane for pH readings and a Pt sensor for redox measurements.

To avoid clogging problems and ensure a fast response, the pH bulb must be kept moist at any time. Store the electrode with a few drops of HI70300 storage solution in the protective cap.

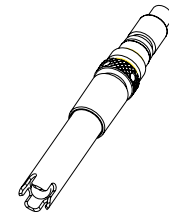

The EC sensor also works as matching pin and must be always mounted to have correct pH readings.

For correct redox measurements, the surface of the electrode must be clean and smooth, and a pretreatment procedure should be performed to ensure quick response.

Since the Pt/PtO system depends on the pH, the pretreatment of the electrode may be determined by the pH and the redox potential values of the solution to be measured.

As a general rule, if the ORP (mV) reading corresponding to the solution pH value is higher than the values in the table below, an oxidizing pretreatment is necessary; otherwise perform a reducing pretreatment.

pH	mV	pH	mV	pH	mV	pH	mV	pH	mV	pH	mV	pH	mV
0	990	1	920	2	860	3	800	4	740	5	680		
6	640	7	580	8	520	9	460	10	400	11	340		
12	280	13	220	14	160								

For reducing pretreatment: immerse the electrode for a few minutes in HI 7091.

For oxidizing pretreatment: immerse the electrode for a few minutes in HI 7092.

1.5.2 Specifications of Sensors

	HI769828-0	HI769828-1	HI769828-2	HI769828-3
Description	pH	pH/ORP	DO	EC
Measure Type	pH, mV (pH)	pH, mV (pH), mV	DO (% sat. & conc.)	EC, TDS, resistivity, salinity
Measure Range	0.00 to 14.00 ±600.0 mV (pH)	0.00 to 14.00 ±600.0 mV (pH) ±2000.0 mV	0.0 to 500.0 % 0.00 to 50.00 mg/L	0.000-200.000 mS/cm 0-400000 mg/L 0 to 1.0000 MΩ*cm 0.00 to 70.00 PSU
Color Code	Red	Red	White	Blue
Materials	Tip: glass (pH) Junction: cloth Body: PEI Electrolyte: gel Reference: double	Tip: glass (pH); Pt (ORP) Junction: cloth Body: PEI Electrolyte: gel Reference: double	Cat/An: Ag/Zn Membrane: PTFE Body: PVC	Rings: Stainless steel AISI 316 Body: PVC
Maintenance Solution	HI 70300 (storage)	HI 70300 (storage)	HI 7042S (membrane refilling)	-
Dimensions	100 x 14 Ø mm	100 x 14 Ø mm	101 x 16.5 Ø mm	111 x 14 Ø mm

1.5.3 DO Sensor Activation

The DO probe is shipped dry. To hydrate the sensor and prepare it for use, proceed as follows:

- Remove the black & red plastic cap. This cap is used for shipping purposes only and can be thrown away.
- Insert the supplied O-ring in the membrane.
- Rinse the supplied membrane with some electrolyte solution while shaking it gently. Refill with clean electrolyte. Gently tap the membrane over a surface to ensure that no air bubbles remain trapped. To avoid damaging the membrane, do not touch it with your fingers.
- With the sensor facing down screw the cap clockwise to the end of the threads. Some electrolyte will overflow.

1.5.4 Installation

The multisensor probe can support 3 different sensors: DO, EC, pH or pH/ORP. To make easier the installation, the sensors are color coded.

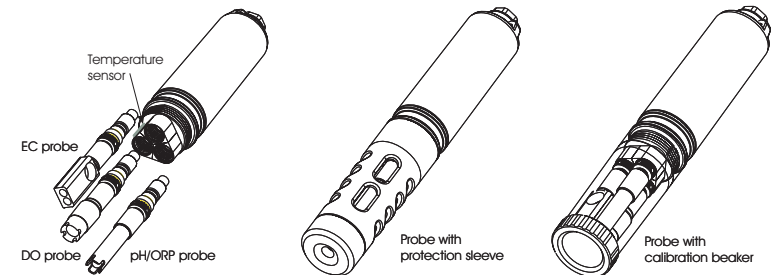

For a correct installation, proceed as follow:

- Grease the O-ring gaskets.
- Insert the sensor while paying attention to the correct alignment with the corresponding colored connector. Fix the sensor by screwing the locking nut with the supplied tool.
- When all sensors are mounted, screw the protection sleeve for taking measurements or the transparent beaker for calibrating.
- With the meter off, connect the probe to the DIN socket on the bottom of the instrument by aligning the pins and pushing in the plug. Tighten the nut to ensure good connection.

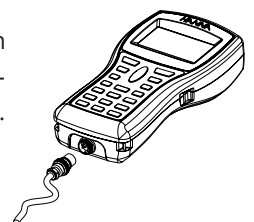

1.6 SPECIFICATIONS

TEMPERATURE

Range	-5.00 to 55.00 °C; 23.00 to 131.00 °F; 268.15 to 328.15 K
Resolution	0.01 °C; 0.01 °F; 0.01 K
Accuracy	± 0.15 °C; ± 0.27 °F; ±0.15 K
Calibration	Automatic at 1 custom point

pH

Range	0.00 to 14.00 pH; ± 600.0 mV
Resolution	0.01 pH; 0.1 mV
Accuracy	± 0.02 pH; ± 0.5 mV
Calibration	Automatic 1, 2 or 3 points with 5 memorized standard buffers (pH 4.01, 6.86, 7.01, 9.18, 10.01) or 1 custom buffer

ORP

Range	± 2000.0 mV
Resolution	0.1 mV
Accuracy	± 1.0 mV
Calibration	Automatic at 1 custom point

DISSOLVED OXYGEN

Range	0.0 to 500.0 % 0.00 to 50.00 mg/L
Resolution	0.1 % 0.01 mg/L
Accuracy	0.0 to 300.0 %: ± 1.5 % of reading or ± 1.0% whichever is greater; 300.0 to 500.0 %: ± 3% of reading 0.00 to 30.00 mg/L: ± 1.5 % of reading or 0.10 mg/L whichever is greater; 30.00 mg/L to 50.00 mg/L: ± 3% of reading
Calibration	Automatic 1 or 2 points at 0, 100 % or 1 custom point

CONDUCTIVITY

Range	0.000 to 200.000 mS/cm (actual EC up to 400 mS/cm)
Resolution	
Manual	1 μS/cm; 0.001 mS/cm; 0.01 mS/cm; 0.1 mS/cm; 1 mS/cm
Automatic	1 μS/cm from 0 to 9999 μS/cm 0.01 mS/cm from 10.00 to 99.99 mS/cm 0.1 mS/cm from 100.0 to 400.0 mS/cm
Automatic mS/cm	0.001 mS/cm from 0.000 to 9.999 mS/cm 0.01 mS/cm from 10.00 to 99.99 mS/cm 0.1 mS/cm from 100.0 to 400.0 mS/cm
Accuracy	±1 % of reading or ±1 μS/cm whichever is greater
Calibration	Automatic at 1 point with 6 memorized standards (84 μS/cm, 1413 μS/cm, 5.00 mS/cm, 12.88 mS/cm, 80.0 mS/cm, 111.8 mS/cm) or custom point

RESISTIVITY

Range	0 to 999999 Ω·cm; (depending on measurement setup) 0 to 1000.0 kΩ·cm; 0 to 1.0000 MΩ·cm
Resolution	Depending on resistivity reading
Calibration	Based on conductivity or salinity calibration

TDS

Range	0 to 400000 mg/L or ppm; (the maximum value depends on the TDS factor)
Resolution	
Manual	1 mg/L (ppm); 0.001 g/L (ppt); 0.01 g/L (ppt); 0.1 g/L (ppt); 1 g/L (ppt)
Automatic	1 mg/L (ppm) from 0 to 9999 mg/L (ppm) 0.01 g/L (ppt) from 10.00 to 99.99 g/L (ppt) 0.1 g/L (ppt) from 100.0 to 400.0 g/L (ppt)
Automatic g/L (ppt)	0.001 g/L (ppt) from 0.000 to 9.999 g/L (ppt) 0.01 g/L (ppt) from 10.00 to 99.99 g/L (ppt) 0.1 g/L (ppt) from 100.0 to 400.0 g/L (ppt)
Accuracy	±1 % of reading or ±1 mg/L (ppm) whichever is greater
Calibration	Based on conductivity or salinity calibration

SALINITY

Range	0.00 to 70.00 PSU (extended Practical Salinity Scale)
Resolution	0.01 PSU
Accuracy	±2% of reading or ±0.01 PSU whichever is greater
Calibration	1 custom point

SEAWATER SPECIFIC GRAVITY

Range	0.0 to 50.0 σ_t , σ_{0t} , σ_{15}
Resolution	0.1 σ_t , σ_{0t} , σ_{15}
Accuracy	± 1 σ_t , σ_{0t} , σ_{15}
Calibration	Based on conductivity or salinity calibration

ATMOSPHERIC PRESSURE

Range	450 to 850 mmHg; 17.72 to 33.46 inHg; 600.0 to 1133.2 mbar; 8.702 to 16.436 psi; 0.5921 to 1.1184 atm; 60.00 to 113.32 kPa
Resolution	0.1 mmHg; 0.01 inHg; 0.1 mbar 0.001 psi; 0.0001 atm; 0.01 kPa
Accuracy	± 3 mmHg within ± 15 °C from the temperature during calibration
Calibration	Automatic at 1 custom point

GENERAL CHARACTERISTICS

Temperature Compensation	automatic from -5 to 55 °C (23 to 131 °F)
Logging Memory(*)	Up to 60,000 samples with 13 measurements each; up to 45,000 samples with 15 measurements each (w/GPS)
Logging Interval	1 second to 3 hours
PC Interface	USB (with HI 929828 software)
Waterproof Protection	Meter IP67, Probe IP68
Environment	0 to 50 °C (32 to 122 °F); RH 100 %
Power Supply	4 x 1.5 V alkaline, C size batteries (approx. 150 hours of use, w/out backlight and GPS); 4 x 1.2 V rechargeable C size, Ni-MH batteries (approx. 70 hours of use, w/out backlight and GPS)
Dimensions	
Meter	221 x 115 x 55 mm (8.7 x 4.5 x 2.2")
Probe	L = 270 (10.6"), dia = 46 mm (1.8")
Weight	
Meter	750 g (26.5 oz.)
Probe (w/out cable)	750 g (26.5 oz.)

* Without remarks. When using remarks the maximum number of samples decreases.

1.7 DISPLAY & KEYBOARD DESCRIPTION

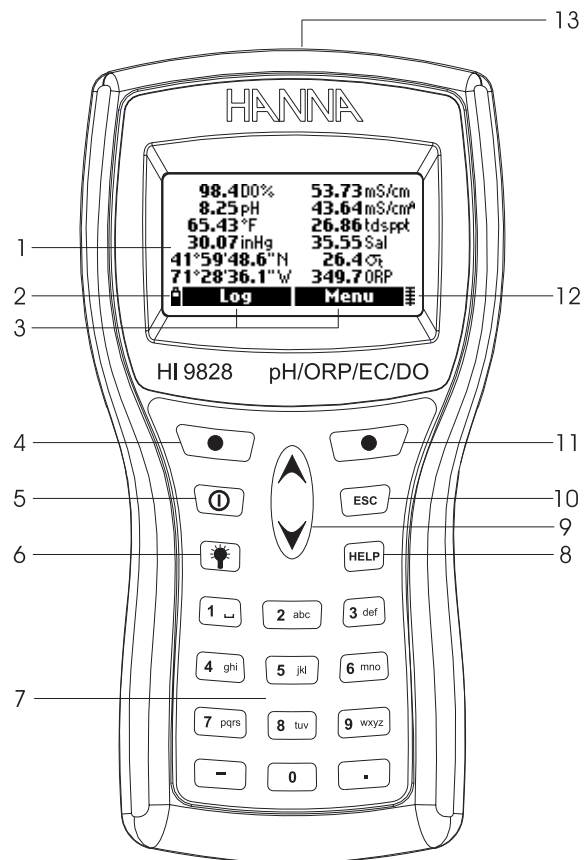

1. Graphic LCD
2. Battery level indicator
3. Softkey functions
4. Left softkey: function defined on display
5. On/off key: to turn the meter on and off
6. Lamp key: to turn the backlight on and off
7. Alphanumeric keyboard: to insert alphanumeric codes
8. HELP key: to obtain information about the displayed screen
9. Arrow keys: to scroll the displayed options/message
10. ESC key: to return to the previous screen
11. Right softkey: function defined on display
12. Indicator of GPS signal strength (optional)
13. Tag reader

1.8 HELP FUNCTION

HI9828 features a context sensitive HELP, which provides useful information regarding the displayed screen.

Simply press the HELP key to access this function, then use the arrow keys if you need to scroll long messages.

To escape from the HELP window, press HELP key again or ESC.

Chapter 2 - MEASUREMENT MODE

HI9828 can read at the same time different parameters from the same probe. As described in the previous section, up to 3 sensors can be mounted on the probe.

- Connect the probe to the meter and carefully fix the probe protection sleeve.
- Immerse the probe into the sample while paying attention to avoid stones.
- Press the on/off key to turn the meter on: the display shows “HANNA HI9828” and the firmware version, then enters the measurement mode.
- The display shows the readings of all enabled parameters and the location coordinates (depending on model and if the GPS feature is enabled). See Chapter 3 for details.
- Press <Log> to store the readings or <Menu> to enter in the main menu. See Chapter 5 for details.

Note If no probe is detected, the message “Probe disconnected!” appears. In this case only the <Menu> softkey is available and only a few functions are active (i.e. those that not require readings).

Up to 12 measurements can be enabled at the same time, and based on number of enabled parameters, the display automatically changes its resolution and sizes the digits to fit the screen.

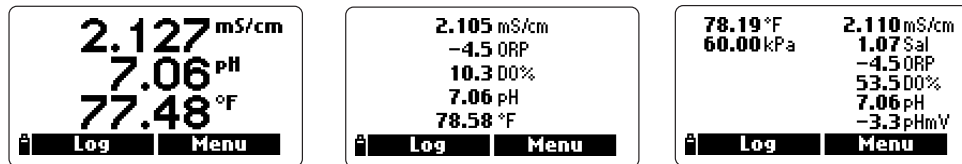

A small “A” letter added to the $\mu\text{S}/\text{cm}$ or mS/cm unit, refers to an actual conductivity value, i.e. the conductivity reading with no temperature compensation.

When a measurement is out of range or not available, the nearest full scale value will slowly and continuously blink.

If GPS is enabled and no GPS signal is received, the last detected GPS coordinates will blink on the LCD.

Press the lamp key, to turn the backlight on and off. After one minute with no key pressed, the backlight automatically turns off.

Chapter 3 - SETUP MODE

A few parameters have to be set before taking any measurements. In the main menu two setup options are available: “Measurement” and “System”.

Measurement setup allows to set the displayed readings and their units, while the system setup is used to set all system parameters, as the interface language, date and time, LCD contrast, acoustic signals, etc.

3.1 MEASUREMENT SETUP

- Switch the meter on by pressing on/off.

After the initialization has been completed, the meter enters the measurement mode. The active softkeys are <Log> and <Menu>.

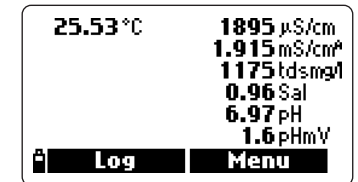

- Press <Menu>, select “Measurement Setup” using the arrow keys, then press <OK>.

- The display shows the complete list of measurable parameters.

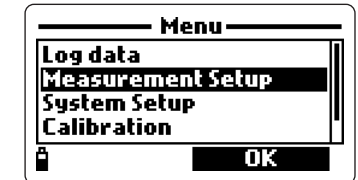

- To select a parameter, scroll with the arrow keys.

Each parameter can be enabled or disabled. A checked box or the measure unit means that the parameter is enabled. Press the right softkey to enable or disable the parameter.

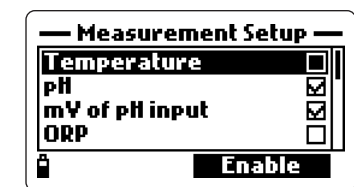
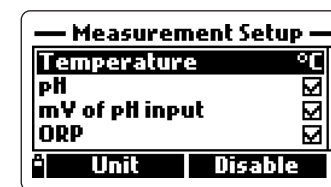

Some parameters also allow to select measure unit and resolution by pressing the <Unit> or <Resolution> softkey respectively.

Note If the password protection is enabled, the meter will ask to insert the password prior to change the first parameter.

Temperature

The user can select the measure unit: °C, °F or K.

pH, pH-mV, ORP, DO % Saturation, Salinity

These parameters can only be enabled or disabled; measure unit and resolution are fixed.

DO concentration

The user can select ppm or mg/L measure unit.

Conductivity and Actual Conductivity

The user can select among the following options: Auto (autoranging for all $\mu\text{S}/\text{cm}$ and mS/cm ranges), $1 \mu\text{S}/\text{cm}$, $0.001 \text{ mS}/\text{cm}$, $0.01 \text{ mS}/\text{cm}$, $0.1 \text{ mS}/\text{cm}$, $1 \text{ mS}/\text{cm}$, Auto mS (autoranging for mS/cm ranges).

Note Actual conductivity is the conductivity value measured with no temperature compensation.

Resistivity

The user can select the measure unit among $\Omega\cdot\text{cm}$, $\text{k}\Omega\cdot\text{cm}$ and $\text{M}\Omega\cdot\text{cm}$.

TDS

The user can select among the following options: Auto (autoranging for all ppm [mg/L] and ppt [g/L] ranges), 1 ppm (mg/L), 0.001 ppt (g/L), 0.01 ppt (g/L), 0.1 ppt (g/L), 1 ppt (g/L), Auto ppt (g/L) (autoranging for ppt [g/L] ranges).

Note For setting ppm or mg/L, see paragraph 3.2 "System Setup".

Seawater specific gravity

This parameter is widely used for seawater analysis, it is similar to a density measurement and gives indication about the salt content. It depends on water pressure, temperature and salinity.

In the seawater specific gravity menu the user can select the reference temperature: σ_t , σ_0 and σ_{15} (i.e. current temperature, 0°C and 15°C).

Atmospheric pressure

The user can select among the following measure units: atm, kPA, mmHg, inHg, mbar, psi.

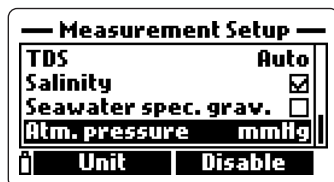
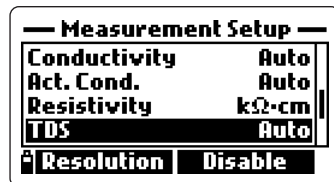
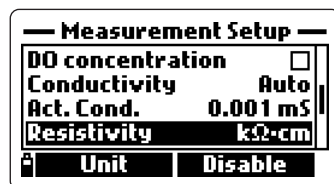
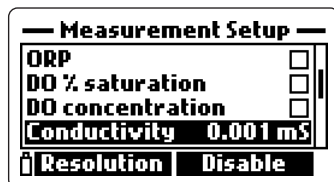
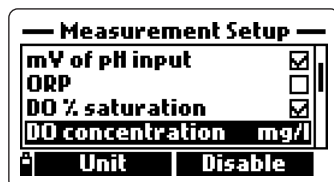

Note A maximum of 12 measurements can be displayed simultaneously. A warning message appears if trying to enable more than 12 measurements.

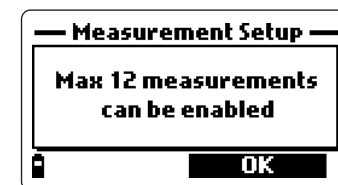

GPS data (only for model with GPS)

GPS data can be customized to meet specific requirements.

The user can select the format of GPS coordinates among the following options: $xx^\circ xx' xx.x''$; $xx^\circ xx.xxx'$; $xx.xxxxx^\circ$. This format will be used to show GPS coordinates in any screen where they appear (even if the "GPS data" option is disabled).

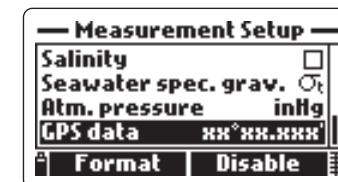

3.2 SYSTEM SETUP

- From measurement mode, press <Menu>, select "System Setup" using the arrow keys and then press <OK>.
- Highlight the desired parameter using the arrow keys, then press <Modify>.

Note If the password protection is enabled, the meter will ask to insert the password prior to change the first parameter.

Language

The display language can be selected among the following available options: English, Spanish, French, Portuguese and Italian. Press the <Modify> softkey to set the desired option.

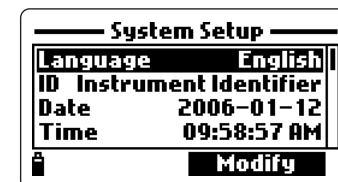

ID

The meter can be labelled with an identification code: press <Modify> and a text box will be displayed. Use the keyboard to insert the desired alphanumeric code and then press <OK>. A maximum of 25 characters can be used.

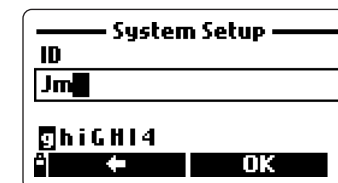

Date

Select the desired date format by pressing repeatedly the <Format> softkey. Available formats are DD/MM/YYYY, YYYY-MM-DD and MM/DD/YYYY. Use the keyboard to insert the date and press <OK> to confirm.

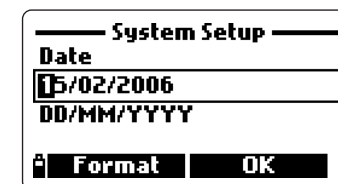

Time

Select the desired time format by pressing repeatedly the <Format> softkey. Available formats are hh:mm:ss (24 hours) and hh:mm:ss (12 hours).

Use the keyboard to insert the time and press <OK> to confirm.

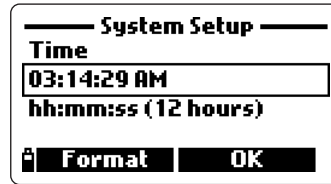
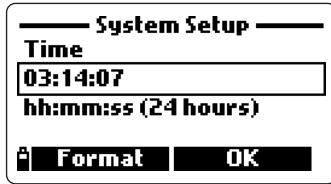

To choose AM or PM, press A or P on the keyboard after inserting the time.

Auto off

The meter automatically shuts off if no key is pressed for the set time. Press the <Modify> softkey to select the desired option: No (disabled), 5, 10, 15, 20, 30 or 60 minutes.

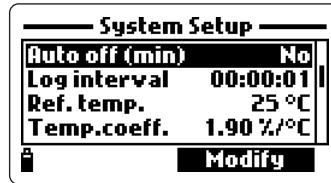

Log interval

Set the logging interval time from 1 second to 3 hours.

Reference temperature

For conductivity readings, a reference temperature for the displayed value has to be set. Available options are 20°C and 25°C. Press the <Modify> softkey to select the desired option.

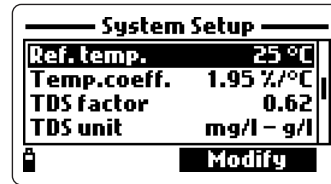

Temperature coefficient

The coefficient for temperature compensation can be set from 0.00 (no temperature compensation) to 6.00%/°C. Press <Modify> and then use the keyboard to insert the desired value. Use the left arrow softkey to move the cursor. To confirm the value press <OK>.

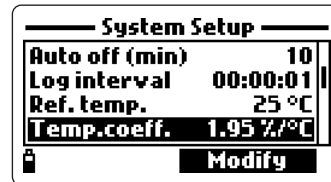

TDS factor

The TDS conversion factor can be set from 0.00 to 1.00.

A typical TDS factor for strong ionic solutions is 0.5, while for weak ionic solutions (e.g. fertilizers) is 0.7.

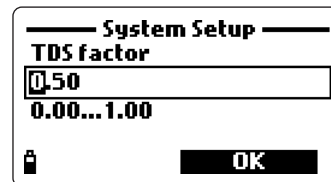

To set this parameter, press <Modify>, insert the value and press <OK> to confirm.

TDS unit

TDS readings can be displayed in ppm-ppt or mg/L-g/L unit. Press <Modify> to select the desired option.



Average length

In order to obtain an average and more representative measurement with unstable samples, set a reading repetition number for the displayed parameters.

To select the desired average length, press <Modify>. This value can be set from 1 to 30.

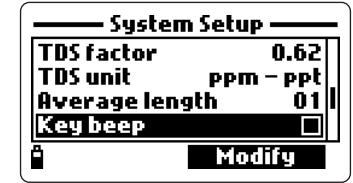

Key beep

If enabled, an acoustic signal sounds every time a key is pressed.

Error beep

If enabled, an acoustic signal sounds every time a wrong key is pressed, or when some particular errors occur.



Decimal separator

The user can select the type of decimal separator: dot or comma. Press <Modify> to select the desired option.

LCD contrast

To set the display contrast level, select the "LCD contrast" setup item and press <Modify>. Use the arrow keys to modify the contrast level and then press <OK> to confirm the new setting.

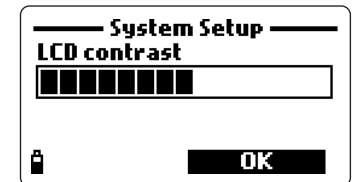

Distance unit (only for model with GPS)

The distance values can be displayed in m-km or ft-mi (feet-miles) unit. Press <Modify> to select the desired option.

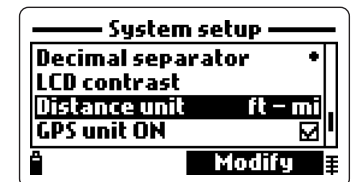

GPS unit ON (only for model with GPS)

This setup item allows to switch the internal GPS unit on and off. Press <Modify> to select the desired option.

Note When not used, switch off the GPS unit to save battery life.

Password

To enable the password proceed as follows:

- Highlight the “Password” setup item and press <Modify>.
- Insert the desired password in the text box and press <OK>.

Note While typing, the characters are masked with “*” (star) symbol.

- The meter will ask to confirm. Type again the same password and then press <OK> to confirm.

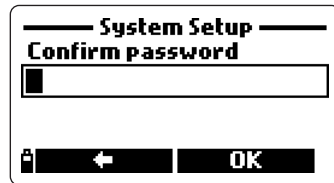
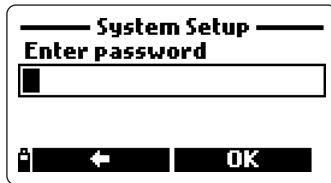

- The meter returns to the “System Setup” menu. The checkbox corresponding to the password item is checked.

To disable the password proceed as follows:

- Highlight the “Password” setup item and press <Modify>.
- Insert the password and then press <Disable>: “NO” appears in the text box.
- Press <OK> to confirm.

Restore factory settings

This item allows to reset all “System Setup” and “Measurement Setup” parameters to their default values.

- Select the “Restore factory settings” item and press <OK>.
- The meter will ask to confirm: press <Yes> to confirm or <No> to escape.

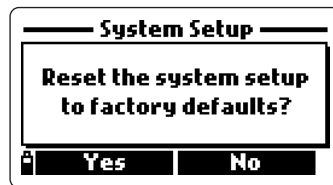

Note To quit the “System Setup” mode at any time, press ESC. For all items for which the new selections have been not confirmed, the meter will keep the previous settings.

3.3 TABLE OF MEASUREMENT AND SETUP ITEMS

Measurement Setup

Item	Description	Default value	Valid Values
Temperature	Temperature unit	°C	K; °C; °F; <input type="checkbox"/>
pH	pH measure	<input checked="" type="checkbox"/>	<input checked="" type="checkbox"/> ; <input type="checkbox"/>
mV of pH input	mV of pH readings	<input checked="" type="checkbox"/>	<input checked="" type="checkbox"/> ; <input type="checkbox"/>
ORP	Redox measure	<input checked="" type="checkbox"/>	<input checked="" type="checkbox"/> ; <input type="checkbox"/>
DO % saturation	Dissolved oxygen measure	<input checked="" type="checkbox"/>	<input checked="" type="checkbox"/> ; <input type="checkbox"/>
DO concentration	Dissolved oxygen measure	ppm	ppm; mg/L; <input type="checkbox"/>
Conductivity	Electrical conductivity measure	Auto	<input type="checkbox"/> ; Auto; 1 μS; 0.001 mS; 0.01 mS; 0.1 mS; 1 mS; Auto mS
Actual conductivity	No temperature compensated conductivity measure	Auto	<input type="checkbox"/> ; Auto; 1 μS; 0.001 mS; 0.01 mS; 0.1 mS; 1 mS; Auto mS
Resistivity	Resistivity measure	MΩ·cm	Ω·cm; kΩ·cm; Ω·cm
TDS	Total dissolved solids measure	Auto	<input type="checkbox"/> ; Auto; 1 ppm; 0.001 ppt; 0.01 ppt; 0.1 ppt; 1 ppt; Auto ppt
Salinity	Salinity measure	<input checked="" type="checkbox"/>	<input checked="" type="checkbox"/> ; <input type="checkbox"/>
Seawater specific gravity	Specific gravity measure	σ _t	<input type="checkbox"/> ; σ _t ; σ ₀ ; σ ₁₅
Atmospheric pressure	Atm. pressure measure	<input type="checkbox"/>	<input type="checkbox"/> ; mmHg; inHg; mbar; psi; atm; kPa
GPS data (*)	Format of the GPS coordinates	<input type="checkbox"/>	<input type="checkbox"/> ; xx°xx'xx.x"; xx°xx.xxx'; xx.xxxx°

System Setup

Item	Description	Default value	Valid values
Language	Interface language	English	English; Español; Français; Português; Italiano
ID	Meter identification code	-	Max 25 characters
Date	Update calendar	YYYY-MM-DD	YYYY-MM-DD; MM/DD/YYYY; DD/MM/YYYY
Time	Update clock	hh:mm:ss (24 hours)	hh:mm:ss (12 hours); hh:mm:ss (24 hours)
Auto-off (min)	Auto shut-off after a period of non use	5 min	NO; 5; 10; 15; 20; 30; 60 min

Log interval	Period between 2 subsequent automatic records	00:00:01	00:00:01 to 03:00:00
Ref. temperature	Reference temperature for conductivity measurements	25°C	20°C; 25°C
Temp. coefficient	Temperature coefficient for conductivity measurements	1.90%/°C	0.00 to 6.00%/°C
TDS factor	Conversion factor from conductivity to TDS readings	0.50	0.00 to 1.00
TDS unit	Measure unit for TDS	ppm-ppt	ppm-ppt; mg/L-g/L
Average length	Number of readings for average value calculation	01	1 to 30
Key beep	Acoustic signal for key pressed	<input checked="" type="checkbox"/>	<input checked="" type="checkbox"/> ; <input type="checkbox"/>
Error beep	Acoustic signal for wrong key pressed	<input checked="" type="checkbox"/>	<input checked="" type="checkbox"/> ; <input type="checkbox"/>
Decimal separator	Symbol used for decimal separator of displayed numbers	.	. ; ,
LCD contrast	Contrast level for the LCD	8	0 to 15
Distance unit (*)	Measure unit for distance	m-km	m-km; ft-mi
GPS unit ON (*)	GPS function enabled	<input type="checkbox"/>	<input checked="" type="checkbox"/> ; <input type="checkbox"/>
Password	Password insertion	-	Max 25 characters

(*) only for model featuring GPS system.

Chapter 4 - CALIBRATION MODE

HI9828 allows to perform six different types of calibration, one for each parameter, and a quick single-point procedure for some of them.

Calibration data are stored in the non volatile memory of the probe, so that the same probe can be used with different meters without needing new calibration.

- To perform a calibration procedure, select the "Calibration" option from the main menu and press <OK>.



Note If password protection is enabled and the latest performed action was a not password protected feature, the meter will ask to insert the password.

- Select the desired calibration type with the arrow keys and then press <OK>.

Available options are:

Quick calibration (single point procedure to calibrate DO saturation, pH and conductivity ranges), pH, DO, conductivity, atmospheric pressure, ORP and temperature.

4.1 QUICK CALIBRATION

The quick calibration feature allows a fast and easy field calibration of the multisensor probe, using only one solution (HI9828-25).

- Fill the calibration beaker with the HI9828-25 calibration solution.
- Screw the calibration beaker on the probe body. Some solution will overflow.
- Wait a few minutes for the system to stabilize.

- Select the "Quick calibration" option from the "Calibration" menu and press <OK>.

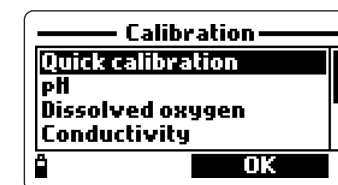

- A 3-item (pH, Conductivity and Dissolved oxygen) screen appears. "pH" starts blinking and the "Not ready" message is shown.

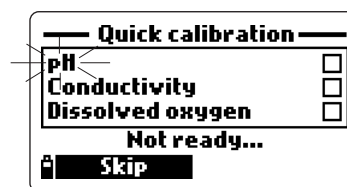

- When the measure is stable, “Ready” is shown. Press <Confirm> to store calibration data.
- The messages “Storing data on probe, please wait...” and “Updating GLP data, please wait...” appear.

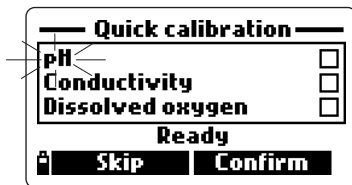

Note If pH calibration is not required, the meter allows to skip to the EC quick calibration, by pressing the <Skip> softkey.

If the pH sensor is missing the message “pH sensor not installed! Skip to conductivity calibration” appears.

- After the pH calibration is completed, the “Conductivity” option will start blinking.
- When the measure is stable, “Ready” appears. Press <Confirm> to store calibration data.
- The messages “Storing data on probe, please wait...” and “Updating GLP data, please wait...” appear.

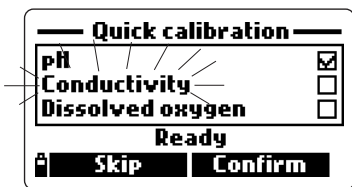

Note If EC calibration is not required, skip to the DO quick calibration, by pressing the <Skip> softkey.

- The message “Empty the beaker. Shake the probe and put it in the beaker again” appears.
- Unscrew the calibration beaker and remove the solution.
- To dry the probe shake it as you would do with a clinical thermometer. Pay attention that no drops remain on the DO sensor.

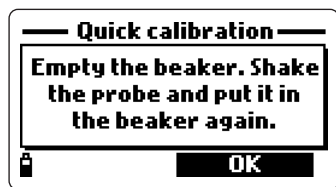

Note Do not use paper to dry the probe, to not damaging the sensor.

- Screw back the calibration beaker on the probe body.
- Wait for stable reading and then press <OK> to close the displayed message.
- When measurement is stable, the message “Ready” appears. Press <Confirm> to store calibration data.
- The messages “Storing data on probe, please wait...” and “Updating GLP data, please wait...” appear.
- The 3-item calibration screen appears again and the checkboxes corresponding to the calibrated parameters will be marked.
- Press <OK> to return to “Calibration” menu.

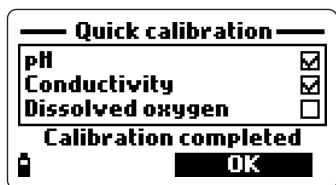

Note To quit a quick calibration procedure, press ESC at any time.

4.2 pH CALIBRATION

It is recommended to calibrate the meter often for pH readings, especially if high accuracy is required.

When the pH calibration is selected, the display shows two options: “Calibrate pH” and “Clear old calibration”.

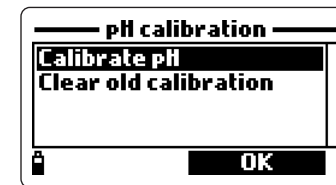

If “Calibrate pH” is selected, the user can perform a new calibration at 1, 2 or 3 points with standard buffers (pH 4.01, 6.86, 7.01, 9.18, 10.01), or a single calibration with custom buffer.

If “Clear old calibration” is selected, all calibration data will be deleted and the default data restored.

Notes Old calibration data have to be deleted every time the pH sensor is replaced and after performing a cleaning procedure.

When a 3-point calibration is performed, all the old data are overwritten, while with a 1 or 2-point procedure the meter will use for the missing points the data previously stored with the last 3-point calibration.

4.2.1 Preparation

Pour small quantities of selected buffer solutions into clean beakers. To minimize cross contamination, use two beakers for each buffer solution: the first one for rinsing the electrode and the second one for calibration.

4.2.2 Procedure

The current measured value is shown on the main part of the display, while the buffer value appears on the secondary level.

If necessary, press the <Buffer> softkey to change the buffer value or insert a custom buffer.

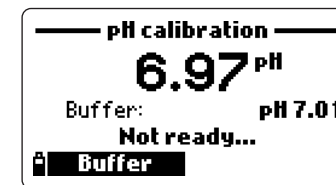

1, 2 or 3-point calibration

- Immerse the probe into the selected buffer and stir gently. The current pH value, the buffer value and “Not ready” are displayed.
- When the reading becomes stable and close to the selected buffer value, the display shows the “Ready” message.

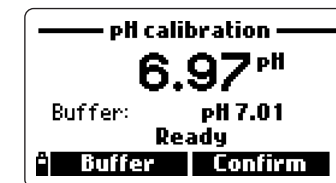

- Press <Confirm> to accept the calibration point or <Buffer> to select another buffer using the arrow keys.
- After the first calibration point is confirmed, immerse the probe in the second buffer solution and stir gently.
- When the reading is stable and close to the selected buffer, the display shows the “Ready” message.
- Press <Confirm> to accept the point or <Buffer> to change the buffer.
- After the second calibration point is confirmed, immerse the probe in the third buffer solution, stir gently and wait for stable reading.
- When the calibration is completed, the display shows the following messages: “Storing data on probe, please wait...”, “Updating GLP data, please wait ...” and “Calibration completed”.
- Press <OK> to return to the “Calibration” menu.
- To return to the main menu, press ESC repeatedly.

Note The pH calibration mode can be quitted at any time, by pressing the ESC key.

Custom buffer calibration

HI9828 also allows a single point procedure to calibrate with a custom buffer value.

- To select this option press first <Buffer> and then <Custom> keys while the meter is waiting for stable reading.
- A text box window will appear for inserting the desired custom value. The valid range for custom buffer is from 0.00 to 14.00 pH.

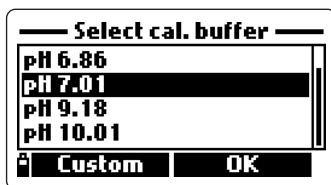

4.2.3 Error List

If the meter does not accept a pH calibration point, a short message is displayed to indicate the possible error source. See for example the following screens:

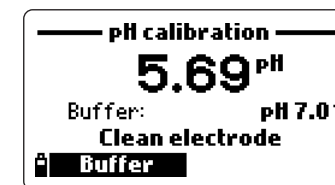
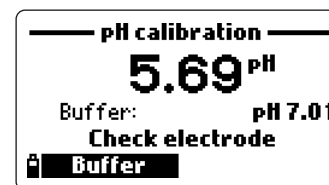
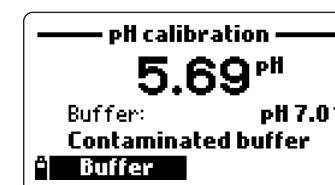
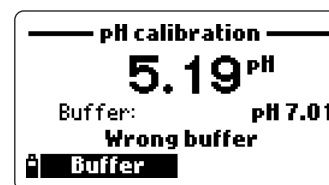

These are the available messages:

- “Input out of scale”: the pH value is out of scale.
- “Wrong buffer”: the pH reading is too far from the selected buffer value. Check if the correct calibration buffer has been selected.
- “Invalid temperature”: the buffer temperature is outside the allowed range.
- “Wrong buffer” / “Contaminated buffer” / “Check electrode”: the buffer is contaminated or the electrode is broken or very dirty.
- “Wrong electrode” / “Check electrode” / “Clean electrode”: the electrode is broken or very dirty.
- “Wrong” / “Clear old calibration”: erroneous slope condition. These messages appear if the slope difference between the current and previous calibration exceeds the slope window (80% to 110%). Press the <Clear> softkey to cancel the old data and continue the calibration procedure, or press ESC to quit the pH calibration mode.

4.3 DISSOLVED OXYGEN CALIBRATION

If the DO % saturation range is calibrated, the DO concentration range will also be calibrated, and vice versa.

The DO % saturation value is referred to the DO concentration in air (100%). For this reason it is recommended to calibrate the probe near the area where the measurements will be taken.

Also note that the DO concentration values are based on DO % saturation, temperature, salinity and atmospheric pressure. It is recommended to use a standard solution or a reference DO meter to compare readings during calibration.

The calibration of the DO % saturation range can be performed at 1 or 2 standard points (0% and 100%), or at a single custom point (50 to 500%).

The calibration of the DO concentration range can be performed at a single custom point (4 to 50 mg/L).

Choose the “DO calibration” from the “Calibration” menu, select the DO calibration type using the arrow keys and press <OK> to confirm.

DO % saturation

The default first calibration point is 100 %.

- Fill the calibration beaker with approximately 4 mm (5/32”) of distilled water and screw it onto the probe.
- The message “Not ready...” is displayed until a stable reading is reached.
- To change the calibration value, press the <Cal. point> softkey and select the desired point.
- To insert a different calibration value, press <Cal. point> and then <Custom>. Insert the desired value using the keyboard.
- When the reading is stable, the “Ready” message is displayed. Press <Confirm> to store the calibration point.
- After the first calibration point is confirmed, put the probe in a zero oxygen standard solution and wait for stable reading.
- Press <Confirm> to store the calibration point.

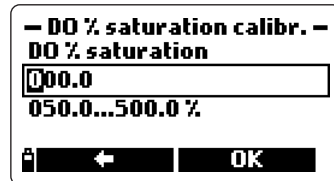
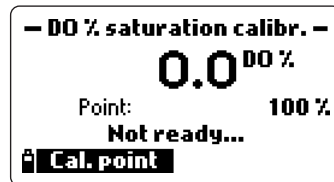
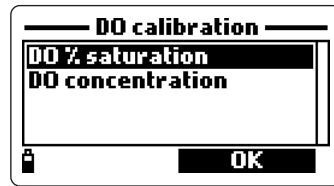

- The following messages will appear: “Storing data on probe, please wait...”, “Updating GLP data, please wait ...” and “Calibration completed”.
- Press <OK> to return to the “Calibration” menu.
- To return to the main menu, press ESC repeatedly.

Note The user can perform a single point calibration with standard values. To abort the procedure, press ESC after the first point is accepted. If the DO input is not within the acceptable range, the message “Invalid input” is displayed.

DO concentration

To calibrate the DO concentration range, a solution with known DO concentration value is needed.

- From the “DO calibration” menu, select the “DO concentration” option, insert the known value and press <OK>.
- When the reading is stable, press <Confirm> to accept the value.
- When the messages “Storing data on probe, please wait...”, “Updating GLP data, please wait ...” and “Calibration completed” appear, the calibration is completed. To return to the “Calibration” menu, press <OK>.
- To return to the main menu, press ESC repeatedly.

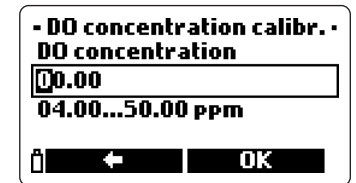

4.4 CONDUCTIVITY CALIBRATION

For a correct conductivity calibration, the probe sleeve must be inserted.

The conductivity calibration menu includes 3 different types of calibration: Conductivity, Actual conductivity and Salinity.

The “Conductivity” option allows a single point calibration with a standard solution selectable by the user. This calibration is temperature compensated.

The “Actual conductivity” option allows a single point calibration with a custom conductivity solution of known actual value (not temperature compensated).

The “Salinity” option allows calibration with a standard salinity solution.

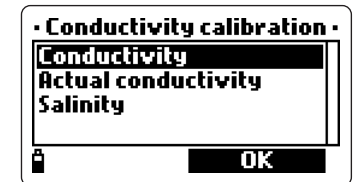

The 3 options are correlated, so that each of the procedures will calibrate all the 3 ranges.

Note For correct EC readings, calibration should be performed using a standard solution with a conductivity value close to the sample to be measured.

After choosing the “Conductivity calibration” mode from the “Calibration” menu, select the calibration type with the arrow keys and then press <OK>.

Conductivity

- Select the “Conductivity” option and press <OK> to confirm.
- Fill a beaker with a standard conductivity solution (see “Accessories” section for choosing the proper HANNA solution).
- Immerse the probe in the solution and wait for stable reading. The probe sleeve must be inserted.
- The main display shows the actual reading, while the secondary level displays the standard value.

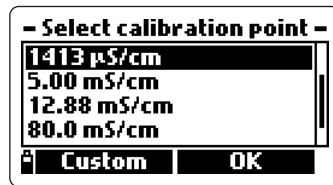
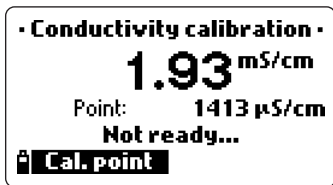

- To change the standard value, press <Cal. point> and the list of available standard values is displayed: 0 µS/cm, 84 µS/cm, 1413 µS/cm, 5.00 mS/cm, 12.88 mS/cm, 80.0 mS/cm and 111.8 mS/cm.
- Press <Custom> to insert a custom value (temperature compensated value). Choose <Resolution> to select the desired resolution.
- When the reading is stable, press <Confirm> to store the calibration data.
- After confirmation, the following messages are displayed: “Storing data on probe, please wait...”, “Updating GLP data, please wait...” and “Calibration completed”.
- Press <OK> to return to the “Calibration” menu.
- To return to the main menu, press ESC repeatedly.

Actual Conductivity

- Select the “Actual conductivity” option and press <OK> to confirm.
- Insert the custom value with the desired resolution. Press <OK> to confirm.
- Immerse the probe in the conductivity solution and wait for stable reading. The probe sleeve must be inserted.
- When the reading is stable, press <Confirm> to store the calibration data.
- After confirmation, the following messages are displayed: “Storing data on probe, please wait...”, “Updating GLP data, please wait...” and “Calibration completed”.
- Press <OK> to return to the “Calibration” menu.
- To return to the main menu, press ESC repeatedly.

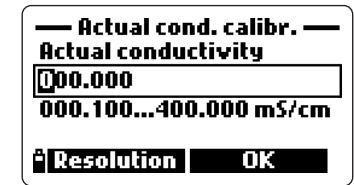

Salinity

- Select the “Salinity” option and press <OK>.
- Insert the salinity value of the custom calibration solution.
- Immerse the probe in the solution and wait for stable reading. The probe sleeve must be inserted.
- When the reading is stable, press <Confirm> to store the calibration data.
- After confirmation, the following messages are displayed: “Storing data on probe, please wait...”, “Updating GLP data, please wait...” and “Calibration completed”.
- Press <OK> to return to the “Calibration” menu.
- To return to the main menu, press ESC repeatedly.

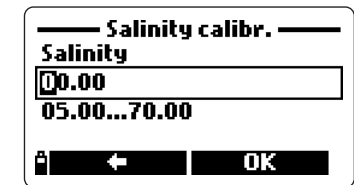

Notes These procedures calibrate the slope value. To calibrate the offset, set the calibration point at 0 µS/cm and repeat the procedure.

If the temperature input is not within the acceptable range (0 to 50°C), the message “Invalid temperature” is displayed.

If the conductivity input is not within the acceptable range, the message “Invalid input” is displayed.

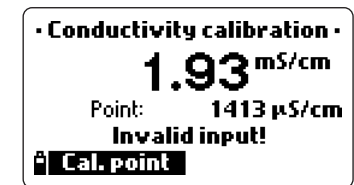

4.5 ATMOSPHERIC PRESSURE CALIBRATION

For this procedure a reference barometer is needed. During calibration the current reading can differ up to 40 mbar from the calibration point.

Choose the “Atmospheric pressure” option from the “Calibration” menu, then select the calibration type using the arrow keys and press <OK>.

- To perform a pressure calibration at a custom point, select the “Custom pressure” option.
- Select the measure unit with the <Unit> key and insert the pressure value with the keyboard.
- Press <OK> and wait for stable reading, then press <Confirm> to store calibration data.
- After confirmation, the following messages are displayed: “Storing data on probe, please wait...”, “Updating GLP data, please wait...” and “Calibration completed”.
- Press <OK> to return to the “Calibration” menu.
- To return to the main menu, press ESC repeatedly.
- To restore the factory calibration, select the corresponding option in the “Pressure calibration” menu and then press <OK>.

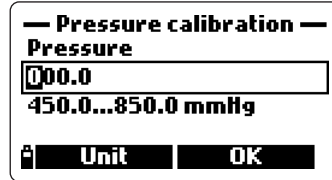
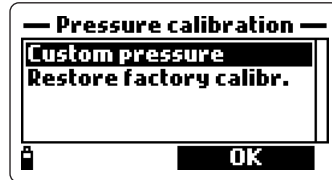

4.6 ORP CALIBRATION

The “ORP calibration” menu allows to perform a single point custom calibration or to restore the factory calibration.

- Select the “Custom ORP” option and press <OK>.
- Fill a beaker with a ORP solution (see “Accessories” section to choose the proper HANNA solution).
- Using the keyboard, insert the solution value and then press <OK> to confirm.
- When the reading is stable, press <Confirm> to store the calibration point.

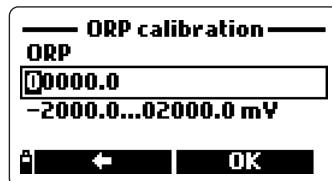

- After confirmation, the following messages are displayed: “Storing data on probe, please wait...”, “Updating GLP data, please wait...” and “Calibration completed”.
- Press OK to return to the “Calibration” menu.
- To return to the main menu, press ESC repeatedly.
- To restore the factory calibration data, select the corresponding option in the “ORP calibration” menu and then press <OK>.

4.7 TEMPERATURE CALIBRATION

The meter is factory calibrated for temperature readings. If necessary, temperature calibration may be performed as explained below.

- Select “Temperature” option from the “Calibration” menu and press <OK> to enter the temperature calibration mode.
- Insert the probe in a thermostatic bath.
- Select the measure unit (°C, °F or K) and insert the bath temperature value (measured with a reference thermometer).
- When the reading is stable, “Ready” appears on the LCD.
- Press <Confirm> to store the calibration point.
- After confirmation, the following messages are displayed: “Storing data on probe, please wait...”, “Updating GLP data, please wait...” and “Calibration completed”.
- Press <OK> to return to the “Calibration” menu.
- To return to the main menu, press ESC repeatedly.

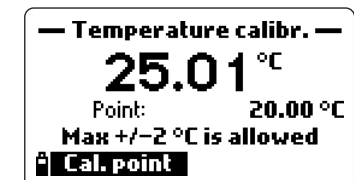
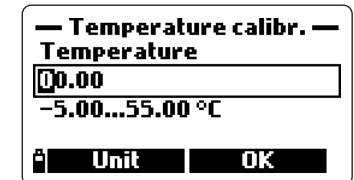

Note The meter allows a maximum difference of $\pm 2^{\circ}\text{C}$ between the current reading and the set value. If this condition is not satisfied, the display shows the warning message “Max +/-2°C is allowed”.

Chapter 5 - GPS MENU (optional)

HI9828 model featuring GPS (Global Positioning System) is provided with a built-in 12 channel receiver and antenna to calculate meter position and track locations along with measurement data.

The GPS unit tracks locations using satellites, with a position accuracy of 10 meters (30 ft).

The GPS coordinates are shown on the LCD together with up to 10 measurement parameters, and are recorded with logged data.

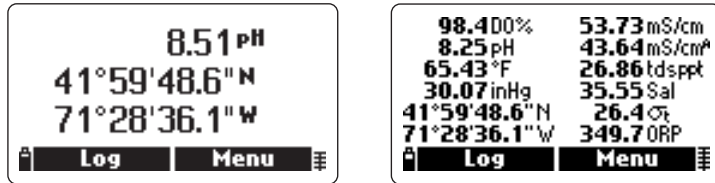

The GPS signal strength is always displayed through a 5-element indicator on the bottom right corner of the LCD. If only one blinking element is displayed, the satellite acquisition is not yet completed or the signal strength is not sufficient (in this case try to move outdoor to see if the signal strength improves).

The user can associate GPS coordinates with alphanumeric locations, which will be assigned to the logged data.

- To enter the GPS menu, press <Menu> from measurement mode, select the "GPS menu" option and press <OK> to confirm.
- Highlight the desired option using the arrow keys, then press <OK>.
- The <GPS OFF> or <GPS ON> softkey is also displayed to change the GPS enabling status. If position data are not required, switch off the GPS unit in order to save the battery life.



Available options: All locations, Nearby locations, Clear all locations and GPS diagnostics.

All locations

This option allows to view all stored locations in alphabetical order. If the GPS unit is on, for each location the distance from the current position is also indicated.

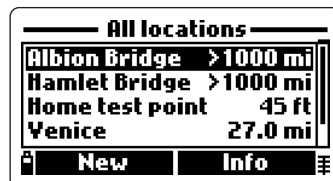
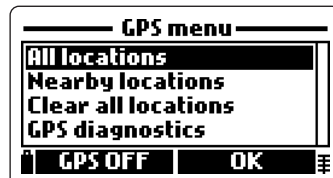

Press <Info> to view the GPS coordinates of the selected location; latitude and longitude. Press <Delete> to cancel the selected location.

Note If the location is associated to an existing lot, the meter will not allow to cancel it. To delete the location, first download the lot data to the PC using the **HI929828** software, then erase the lot from the meter memory.

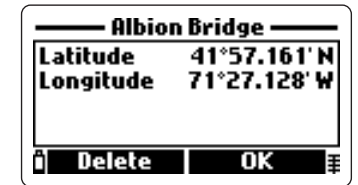

Press <New> to add a new location to the existing list, then choose one of the two proposed options: "Current position to location" or "Add location manually".

In the first case the meter asks to enter the location ID only, while for manual addition also the latitude and longitude information has to be entered.

The meter can store up to 50 locations.

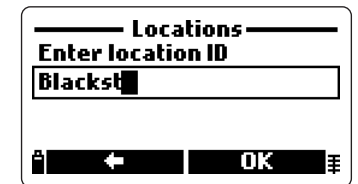
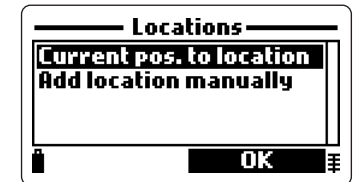

Nearby locations

This option allows to view the nearby locations, listed from the nearest to the farthest one. For each location the distance from the current position is also indicated.

This list is not available if the GPS unit is off or GPS signal is not available.

The nearby locations include up to 20 locations within a distance of 30 meters or the first 10 available locations.

Locations at a distance greater than 1000 km (or 1000 miles) are not included among the nearby locations.

Press <Info> to view the GPS coordinates of the selected location; latitude and longitude. Press <Delete> to cancel the selected location.

Note If the location is associated to an existing lot, the meter will not allow to cancel it. To delete the location, first download the lot data to the PC using the **HI929828** software, then erase the lot from the meter memory.



Press <New> to add a new location to the existing list, then choose one of the two available options: "Current position to location" or "Add location manually".

In the first case the meter asks to enter the location ID only, while for manual addition also the latitude and longitude information has to be entered.

Clear all locations

Choose this option to delete all locations. The meter will ask to confirm before proceeding, by displaying the message "All location information will be erased. Continue?".

Press <Yes> to confirm deletion or <No> to return to the previous screen.

Note If any location is associated to an existing lot, the meter will not allow to cancel it.

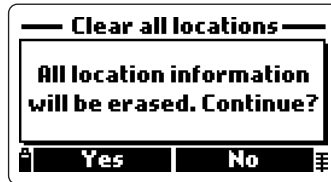

GPS diagnostics

This option allows to view the following GPS information: latitude and longitude of the current position, number of acquired satellites, time elapsed since last detected position (if the GPS signal is not currently available).

Pressing the <Locations> softkey will enter the "Nearby locations" screen.

Pressing the <GPS OFF> softkey will disable the GPS unit.

Pressing the <GPS ON> softkey will enable the GPS unit and show the GPS receiver model and version, together with the "Acquiring satellites..." message.

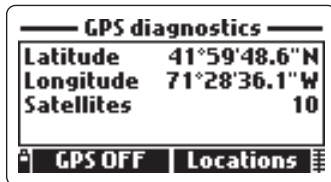

Chapter 6 - LOGGING MODE

HI9828 can store up to 60,000 samples in 100 different lots, if the GPS unit is not enabled (if available). If readings are stored also using the GPS feature, the maximum number of samples is 45,000. In both cases, when using remarks, the maximum number of stored measurements decreases.

6.1 LOGGING

- From measurement mode press <Log> to store the enabled readings. The default setting suggests the last used lot to store the sample. Each sample can be associated to a tag by simply touching the tag with the tag reader.
- Press <OK> to accept the proposed lot to store the readings.
- The meter will ask if a location should be associated with the readings (model with GPS enabled only). Press <Yes> to add the location (new or from the nearby existing list); press <No> to skip this option.



- The "SAMPLE LOGGED" message is shown, then the meter returns to the measurement mode.

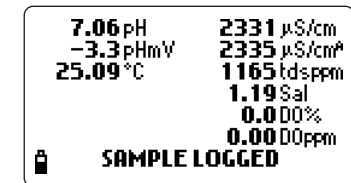
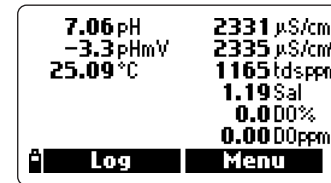

6.1.1 Logging Options

- To insert additional information for the logged value or to select the continuous logging mode, press <Options>.
- The <One sample> and <Continuous> softkeys will appear. Select the desired option.

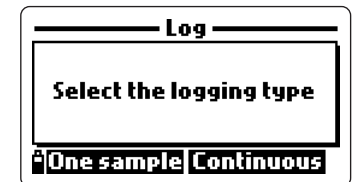

- To choose the storing file, select an existing lot using the arrow keys and press <OK> to confirm. To create a new lot press the <New lot> softkey and use the keyboard to insert the desired code in the displayed text box. Press <OK> to confirm. If the lot name already exists, a warning message advises the user: "The file already exists! Insert a different file name". Press <OK> to insert a different file name.
- Then the "Add remark?" window will appear. If <Yes> is pressed and a remark list already exists, the user can select the desired note or press <New> to insert a new remark in the displayed text box.

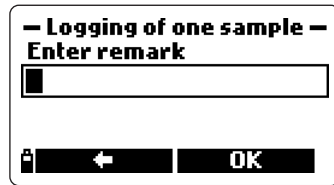
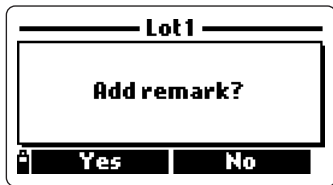

- If GPS is enabled and GPS signal is sufficient, the meter will ask if a location should be associated with the readings. Press <Yes> to add the location (new or from the nearby existing list); press <No> to skip this option.
- The "Tag reading" option allows to associate the sample to a tag. The message "Touch the tag with the tag reader" is displayed. Press <Skip> if no tag is available or to skip this option.
- If the tag is touched, the associated ID will be displayed. If no ID is associated to the tag, the serial number is shown.
- Press <Tag ID> to insert an identification code for the used tag, then press <OK> (or simply press <OK> if you are not interested in a tag ID).

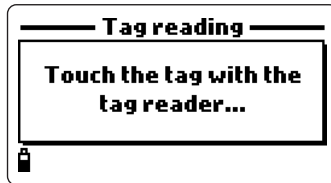

Notes A logging list complete with remarks and locations (model with GPS only), can be created before taking any measurement and logging. See below paragraph "Log data setup". Press ESC to return to the previous screen or keep it pressed to abort the logging procedure completely. In case of continuous logging, the data collection will start after the last option is confirmed. For one sample logging, the data are stored after <Log> is pressed.

6.2 LOG DATA SETUP

To set lots, insert remarks, review logged or plotted data and to delete lots, from the main menu select the "Log data" option and press <OK> to confirm.

A list of available functions appears.

6.2.1 Lots

This option allows to insert a new lot, view logged measurements, plot data or delete lots.

- Use the arrow keys to select the desired lot and then press <OK>.
- To create a new lot press the <New lot> softkey and use the keyboard to insert the identification name. Press <OK> to confirm.

Note The screen top line shows the remaining memory percentage available for inserting new data, for example "Data lots (free: 100%)".

- After <OK> is pressed, the meter displays all data related to the selected lot: number of samples, memory space used, time and date of the first and the last readings.
- If <Options> is pressed, the following functions can be performed: "View" the readings stored in the selected lot; "Plot" the corresponding graph; "Delete" the selected lot.

Note The screen top line indicates the lot name.

View

- Confirm the "View" option and the sample details will be displayed. Use the arrow keys to change the sample number in the selected lot. The sample number is shown on the bottom right corner of the display.

Note Details are available only for the enabled parameters (see section 3.1 "Measurement Setup").

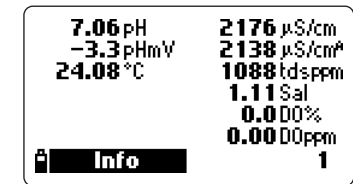
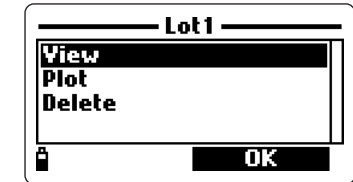
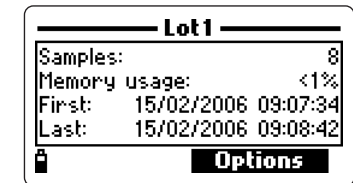
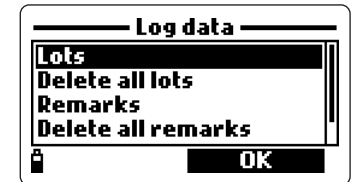

- Press <Info> to see the sample number, time & date, remark, location (only for model with GPS) and tag ID or serial number (if available).
- Press <Data> to return to the previous screen or <Jump> to select a different sample in the same lot. When <Jump> is pressed, a text box appears to insert the desired sample number.
- Press ESC to return to the “View, Plot, Delete” menu.

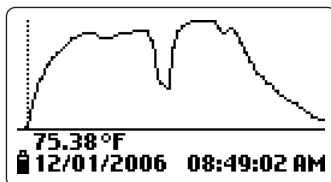
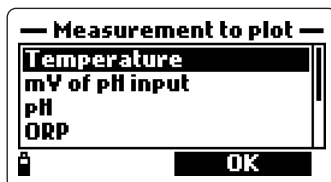
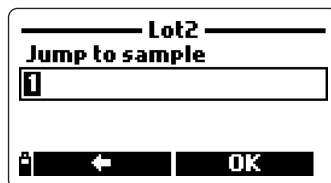
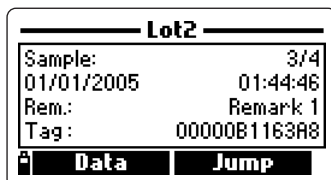

Plot

- Choose “Plot” and the list of the available parameters for the selected lot will appear.
- Use the arrow keys to select the desired parameter. Press <OK> to view the graph.
- Use the arrow keys to move the cursor in the graph and highlight a sample. The sample data are displayed below the graph.
- Press ESC to return to the parameter list.
- Press ESC again to return to the “View, Plot, Delete” menu.

Note The number of lot samples that can be plotted is limited by the display resolution. To view a complete graph download data to PC.

Delete

- Choose “Delete” and the meter will display the message “The selected lot will be erased! Continue?”. Press <Yes> to delete or <No> to return to the previous screen.
- To return to the “Log data” menu, press ESC repeatedly.

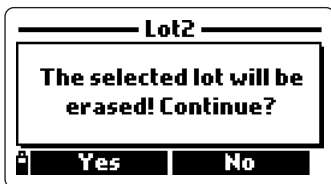

6.2.2 Delete All Lots

- If the “Delete all data” option is selected, the display shows the message “All stored log data will be erased! Continue?”. Press <Yes> to delete or <No> to return to the previous screen.

6.2.3 Remarks

A remark can be associated to each sample, and the meter allows to enter up to 20 remarks.

- To add a remark, highlight the “Remarks” option using the arrow keys and confirm the selection by pressing <OK>.
- The display shows the list of memorized remarks.
- Press <New> to create a new remark and a text box will appear. Insert the desired information using the meter keyboard.
- Press <Delete> to cancel the selected remark. If the deleted remark is used in an existing lot, the information will be still available among the lot data.

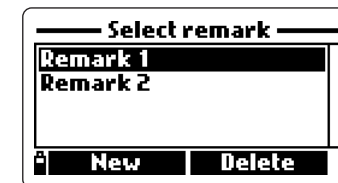

Note During logging each reading can be associated to a remark either selected from a previously created list or new. See paragraph 6.1.1 “Logging options”.

6.2.4 Delete All Remarks

- To delete all existing remarks, use the arrow keys to select the option and press <OK>. The display will show the message “All stored remarks will be erased! Continue?”. Press <Yes> to delete or <No> to return to the previous screen.



6.2.5 Tags

Read tag

- Select the “Read tag” option to view and modify the information associated to a tag, or to insert the ID of a new tag. The display shows the message “Touch the tag with the tag reader”. Touch the tag with the tag reader located on the top of the meter (see page 18).

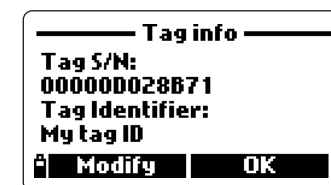
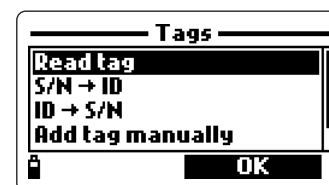

- When the tag is detected the meter displays the tag serial number and ID (if available).

- Press the <Tag ID> softkey (available only if the tag has never been identify) to insert the current tag ID.
- Press <Modify> to change the tag information or <OK> to close the window.

S/N → ID

This option allows to view the ID code associated to a tag serial number.

- Select “S/N→ID” and press <OK>.
- Insert the serial number using the meter keyboard and then press <OK>.
- The tag information window will appear. Press <OK> to return to the previous screen or <Modify> to modify the tag ID.

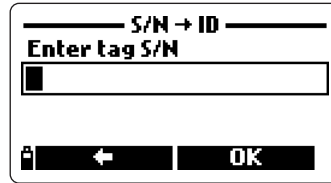

Note If the typed S/N is not stored in the memory, the warning message “This tag S/N is not stored in memory” advises the user.

ID → S/N

This option allows to view the tag serial number related to an ID.

- Select “ID→S/N” and press <OK>.
- Insert the identification code using the meter keyboard and then press <OK>.
- The tag information window will appear. Press <OK> to return to the previous screen or <Modify> to modify the tag ID.

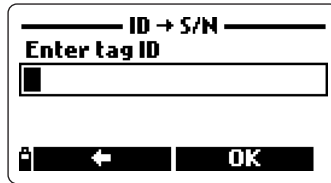

Note If the inserted ID is not present in the memory, a warning message advises the user.

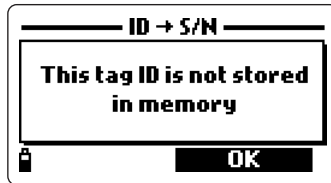

Add tag manually

An ID code can be associated to a tag even if the tag is not physically available.

- Select the proper option and press <OK>.
- Insert the tag serial number using the meter keyboard and then press <OK>.
- Insert an ID code for the added tag and then press <OK>.
- The meter will now display all information just entered.

Clear tag memory

The tag memory can be completely cleared.

- Select the “Clear tag memory” option and press <OK>.

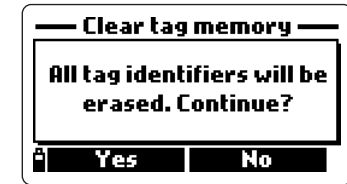
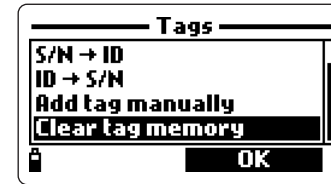

- The message “All tag identifiers will be erased. Continue?” appears.
- Press <Yes> to confirm tag erasing or <No> to return to the previous screen.
- To return to measurement mode, press ESC repeatedly.

Chapter 7 - GLP DATA

GLP (Good Laboratory Practice) is a set of functions that allows to store or recall data regarding the probe calibration. This feature also allows to associate a reading to “certified data” (standard solutions, reference meters, etc.) through the calibration procedure.

To visualize GLP data, from measurement mode press the <Menu> softkey and highlight the “GLP data” option using the down arrow key.

Press <OK> and the complete list of available parameters appears. Select the desired option using the arrow keys and press <OK> to view the relative information.

Note When no calibration data are available for the selected parameter, the display shows the message “No GLP data available for this measurement”. Press <OK> to return to the previous screen.

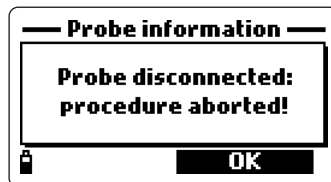
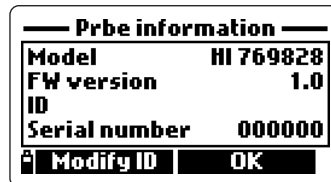
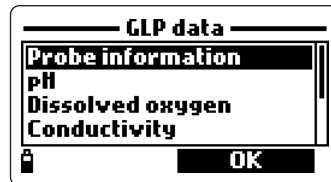
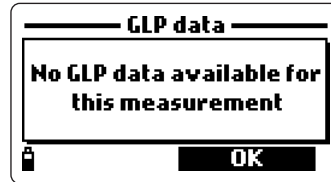
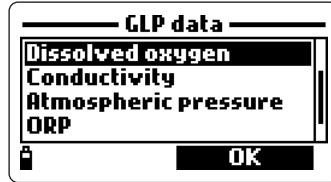

7.1 PROBE INFORMATION

- To view the probe information, select the “Probe information” option and press <OK>.
- The following data appear: model, firmware version, ID and serial number.
- Press <OK> to return to the previous screen or <Modify ID> to change the ID code.
- If <Modify ID> is pressed, a text box appears. Insert the desired code, then press <OK> to confirm or ESC to escape without saving the modification.
- The messages “Storing data on probe, please wait...” and “Data successfully stored on probe” appear.
- Press <OK> to return to the “Probe information” screen.

Note If no probe is connected a warning message appears.

7.2 pH

- From the “GLP data” menu, select the “pH” option and press <OK>.
- All data regarding last pH calibration appear: offset, acidic slope, basic slope, used buffers, time and date of the procedure.
- Use the arrow keys to scroll the stored data of last 5 calibrations.
- Press ESC to return to the “GLP data” menu.

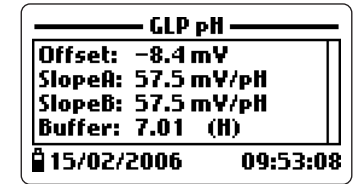

Note The “C” label near the buffer value indicates a custom point, while the “H” indicates HANNA standard value.

If a quick calibration was performed, the buffer values are replaced with the “Quick calibration” indication.

If calibration was cleared, the offset and slope values are the default ones, and the message “Old calibrations cleared” appears.

If no pH calibration has been performed, a warning message advise the user. Press <OK> to return to the previous screen.

7.3 DISSOLVED OXYGEN

- From “GLP data” menu select the “Dissolved oxygen” option and press <OK>.
- All data regarding last DO calibration appear: calibrated points, % saturation or concentration, time and date.
- Use the arrow keys to scroll the last 5 memorized calibrations.
- GLP calibration data for DO include 3 options: 2-point % DO calibration, single point % DO calibration and concentration DO calibration.

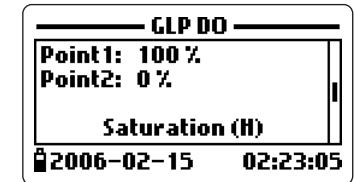

Notes The “C” label near the calibration point indicates a custom point, while the “H” means HANNA standard value.

When the % DO range is calibrated, also the DO concentration range is calibrated, and vice versa.

If no DO calibration has been performed, a warning message advises the user. Press <OK> to return to the previous screen.

7.4 CONDUCTIVITY

- From "GLP data" menu select the "Conductivity" option and press <OK>. This menu allows to view data for conductivity, actual conductivity and salinity calibrations.
- All information regarding last conductivity calibration appears: calibrated point, cell constant value, calibration type (conductivity, actual conductivity or salinity), time and date.

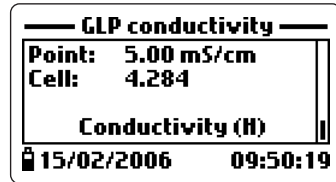
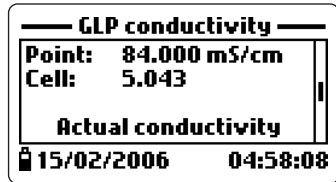
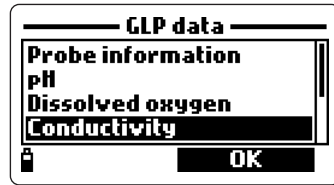

- Use the arrow keys to scroll the last 5 memorized calibrations.
- For conductivity calibration the following screens are available: conductivity, actual conductivity, salinity.

Notes The "C" letter near the conductivity calibration indicates a custom point, while the "H" means HANNA standard value.

If no conductivity calibration has been performed, a warning message advises the user. Press <OK> to return to the previous screen.

If the selected calibration is a factory calibration, the meter shows the message "Factory calibration".

7.5 ATMOSPHERIC PRESSURE

- From "GLP data" menu select "Atmospheric pressure" option and press <OK>.
- All information about last atmospheric pressure calibration appears: custom calibration point, time and date.
- If factory calibration was restored, the display shows the message "Factory calibr. restored".
- Use the arrow keys to scroll the last 5 memorized calibrations.

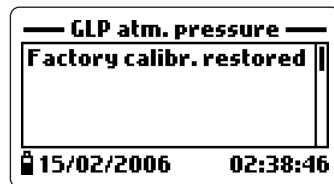

Notes If no atmospheric pressure calibration has been performed, a warning message advises the user. Press <OK> to return to the previous screen.

If the selected calibration is a factory calibration, the meter shows the message "Factory calibration".

7.6 ORP

- From "GLP data" menu select the "ORP" option and press <OK>.
- All data about last ORP calibration appear: calibrated point, time and date.
- If the factory calibration was restored, the display shows the warning message "Factory calibr. restored".
- Use the arrow keys to scroll the last 5 memorized calibrations.

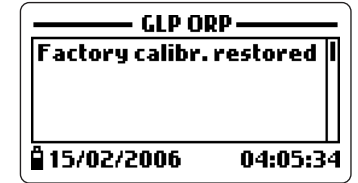

Notes If no ORP calibration has been performed, a warning message advise the user. Press <OK> to return to the previous screen.

If the selected calibration is a factory calibration, the meter shows the message "Factory calibration".

7.7 TEMPERATURE

- From "GLP data" menu select the "Temperature" option and press <OK>.
- All information about last temperature calibration appears: calibrated point, time and date.
- Use the arrow keys to scroll the last 5 memorized calibrations.

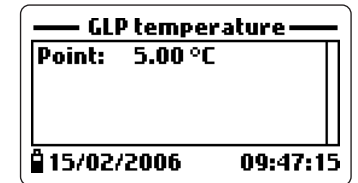

Notes If no temperature calibration has been performed, a warning message advise the user. Press <OK> to return to the previous screen.

If the selected calibration is a factory calibration, the meter shows the message "Factory calibration".

Chapter 8 - PC CONNECTION MODE

The logged data can be transferred to PC using the HI929828 Windows® compatible application software.

HI929828 allows to use the powerful capabilities of most spread sheet programs (e.g. Excel®, Lotus 1-2-3®): simply open the file downloaded by HI929828 from the selected spread sheet program and you can do any elaboration available with the software (e.g. graphics, statistic analysis, etc.). HI929828 offers a variety of features and is provided with an on-line-help to support the user throughout any situation.

Moreover, for samples logged with GPS coordinates, HI929828 allows to automatically generate a map based on a selected list of samples. Simply connect to a GPS tracking software such as Google™ Maps to view locations where measurements have been taken. To use this function, internet connection is required.

8.1 SOFTWARE INSTALLATION

- Insert the installation CD into the PC.
- The software menu window should start automatically (if it does not, go to the main CD folder and double-click "histart.exe"). Click "Install software" and follow the instructions.

8.2 PC CONNECTION

- With the meter OFF, disconnect the probe.
- Connect the HI 7698281 USB adapter to the meter and to the USB port on PC.
- Turn the meter ON and the message "PC connection" appears.
- Run the HI929828 application software, select the number of the used COM port (or use the "Automatic detect" option) within the "Settings" window and then press "Connect".
- HI929828 downloads the logged data. The PC monitor shows the GLP data and the logged lot (see figure on next page). To download and view all samples of a lot, select the desired lot and press the "Get lot" option.
- During download, a visual representation of the transferred data percentage is displayed.

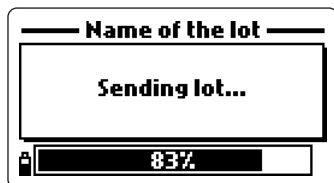

Note To verify which PC COM port number is used for connecting the meter, press the "Detect Selected Instrument" button within the HI929828 "Settings" window. Otherwise, press START in the Windows® task bar, select "Settings" from main menu and then "Control panel", "System", "Hardware", "Device Manager", "Ports". This last menu shows the number of the used COM port near the USB serial port.

The screenshots illustrate the software's data management and visualization capabilities. The 'Instrument status' window displays a table of logged lots with columns for Lot name, Temp, pH, ORP, Cond., DO, and Press. The 'GLP' (Global Log Profile) windows provide detailed measurement data, including dates, times, and various parameters like pH, ORP, DO, and temperature. The map screenshot shows the geographical location of a measurement at Albion Bridge, with a popup displaying specific data: 6.95 pH, 61.8 ORP, 510 µS/cm, 91.6 DO %, 17.65 DO ppm, 1.09°C, and coordinates 41°57.161'N, 71°27.128'W.

Windows® is a registered Trademark of "Microsoft Co."

GOOGLE™ is a registered trademark of Google, Inc. HANNA instruments® has no affiliation with Google™, Inc.

Chapter 9 - ERROR MESSAGES

HI9828 displays a series of messages if probe or meter errors are generated. All possible error messages are listed in this section, together with the meaning and some indications to solve the problem. For quick information the help menu is always available by pressing the "Help" button.

- "Continuous logging - Flash memory is full": the memory is full and no more reading can be logged. Press <OK> and delete one or more lots.
- "Flash memory error!": error in the meter internal memory. Press <OK>, download the data and delete all lots. If the problem persists, contact the HANNA service center.
- "Probe communication error!": there is a communication problem between probe and meter. Check if the cable is correctly connected, turn the meter off, disconnect the probe and connect it again. If the problem persists, contact the HANNA service center.
- "Probe critical error: EEPROM corruption!": the probe EEPROM data are corrupted. Turn the meter off, disconnect the probe and connect it again. If the problem persists, contact the HANNA service center.
- "Probe critical error: ADC blocked!": the probe internal A/D converter does not respond or is blocked. Turn the meter off, disconnect the probe and connect it again. If the problem persists, contact the HANNA service center.
- "Probe critical error: I2C bus fault!": internal transmission not acknowledged or bus fault for more than a certain number of unsuccessful transmission attempts. Turn the meter off, disconnect the probe and connect it again. If the problem persists, contact the HANNA service center.

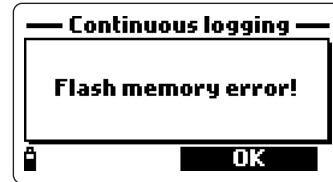

- "Probe critical error": a probe generic error occurred. Turn the meter off, disconnect the probe and connect it again. If the problem persists, contact the HANNA service center.
- "None of the enabled measurements is available": this message appears in measurement mode if no one of the selected parameters is available because the corresponding sensors are not mounted on the probe. Turn the meter off, install the required sensor and proceed with measurements.
- "Please disconnect probe from meter before installing or removing any sensor!": this message appears if the operator removes or mounts a sensor with the meter on and the probe connected. To avoid sensor or probe damages, please turn the meter off before performing any operation on the probe.
- "Error - Valid sensors config. is Temp, pH, ORP, Cond., DO, Pressure" or similar messages: the user is trying to record new samples with different sensor configuration in an existing lot. All logged samples in the same lot must have the same sensor configuration. Press <OK> and change lot.
- "Error - Current date and time precede the last logged sample!": the user is trying to record new data in an existing lot, but the current time and date of the meter precede the time and date of last logged data for the selected lot. Press <OK>, set a correct value for time and date or log in a different lot.
- "I2C bus error!": the internal transmission is not recognized or a certain number of transmission attempts have been unsuccessful. Turn the meter off and on again. If the problem persists, contact the HANNA service center.

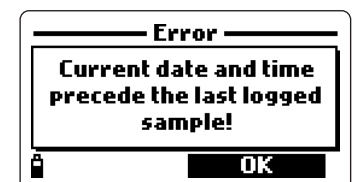
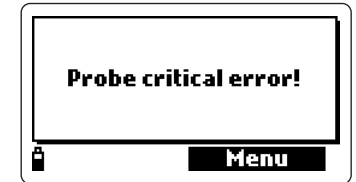

- “GPS signal not available” (only for model with GPS): the GPS signal is not sufficient. Move outdoor to open sky and wait for 15 minutes. If the problem persists, contact the HANNA service center.
- “Communication error with GPS unit” (only for model with GPS): the communication with the internal GPS unit can not be established. Switch the meter off and on again, then retry. If the problem persists, remove the batteries, wait for 5 minutes and install them again. If the problem persists, contact the HANNA service center.

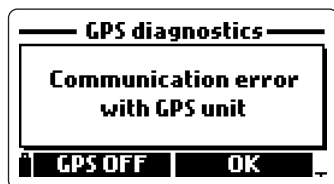
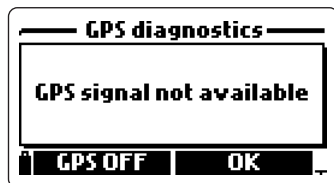

APPENDIX A - PROBE MAINTENANCE

HI9828 is supplied complete with a probe maintenance kit that includes HI7042S (electrolyte solution for DO sensor), 5 spare membranes with O-rings for DO sensor, a small brush for cleaning EC and DO sensors, 5 O-rings for sensor connectors and a syringe with grease to lubricate these O-rings.

General Maintenance

After use rinse the probe with tap water and dry it. The pH electrode bulb must be kept moist. Dry the DO and EC sensors.

Maintenance of DO Sensor

For a top performance probe, it is recommended to replace the membrane every 2 months and the electrolyte monthly.

Proceed as follows:

- Unscrew the membrane by turning it counterclockwise.
- Rinse a spare membrane with some electrolyte while shaking it gently. Refill with clean electrolyte.
- Gently tap the membrane over a surface to ensure that no air bubbles remain trapped.
- With the sensor facing down, completely screw the cap clockwise. Some electrolyte will overflow.



If any deposit scales the sensor, gently brush the sensor surface with the supplied brush, while paying attention to not damage the plastic body.

Maintenance of pH Probe

- Remove the electrode protective cap. Do not be alarmed if any salt deposits are present. This is normal with pH electrodes and they will disappear when rinsed with water.
- Shake down the electrode as you would do with a clinical thermometer to eliminate any air bubbles inside the glass bulb.
- If the bulb and/or junction are dry, soak the electrode in HI70300 storage solution for at least one hour.
- To minimize clogging and ensure a quick response time, the glass bulb and the junction should be kept always moist and not allowed to dry.
- Store the electrode with a few drops of HI70300 storage solution in the protective cap. Tap water may also be used for a very short period (couple of days).



NEVER USE DISTILLED OR DEIONIZED WATER TO STORE THE pH ELECTRODE.

- Inspect the electrode for scratches or cracks. If any is present, replace the electrode.
- Cleaning procedure: clean frequently the probe by soaking it for 1 minute in HI70670 or HI70671 cleaning solution. After cleaning soak the electrode in HI70300 storage solution before taking measurements.

Maintenance of EC Probe

- After every series of measurements, rinse the probe with tap water.
- If a more thorough cleaning is required, clean the probe with the supplied brush or a nonabrasive detergent.

Notes

- After a cleaning procedure, always recalibrate the system.
- Grease the O-rings before installing back the sensors.

APPENDIX B - ACCESSORIES

HI9828 ACCESSORIES

HI 769828/4	Multisensor probe body with 4 m cable
HI 769828/10	Multisensor probe body with 10 m cable
HI 769828/20	Multisensor probe body with 20 m cable

Note: Probes with different cable length are available upon request.

HI 769828-0	pH sensor, double junction, non refillable
HI 769828-1	pH/ORP sensor
HI 769828-2	DO sensor
HI 769828-3	EC sensor
HI 9828-25	Quick calibration solution, 500 mL bottle
HI 9828-27	Quick calibration solution, 1 G bottle
HI 7698281	USB interface cable
HI 929828	Windows® compatible application software
HI 920005	iButton® with holder (5 pcs)
HI 7698282	Probe maintenance kit
HI 7698283	Calibration beaker
HI 7698284	Flow cell
HI 710045	Power supply cable
HI 710046	Cigarette lighter cable
HI 710005	115 Vac/12 Vdc adapter, US plug
HI 710006	230 Vac/12 Vdc adapter, European plug
HI 710012	230 Vac/12 Vdc adapter, UK plug
HI 710013	230 Vac/12 Vdc adapter, South African plug
HI 710014	230 Vac/12 Vdc adapter, Australian plug

pH BUFFER SOLUTIONS

HI 5004	pH 4.01 buffer solution, 500 mL bottle
HI 5046	pH 4.63 buffer solution, 500 mL bottle
HI 5005	pH 5.00 buffer solution, 500 mL bottle
HI 5006	pH 6.00 buffer solution, 500 mL bottle
HI 5068	pH 6.86 buffer solution, 500 mL bottle
HI 5007	pH 7.01 buffer solution, 500 mL bottle

HI 5074	pH 7.41 buffer solution, 500 mL bottle
HI 5008	pH 8.00 buffer solution, 500 mL bottle
HI 5009	pH 9.00 buffer solution, 500 mL bottle
HI 5091	pH 9.18 buffer solution, 500 mL bottle
HI 5010	pH 10.01 buffer solution, 500 mL bottle

ORP SOLUTIONS

HI 7020L	ORP test solution, 200/275 mV @20°C, 500 mL
HI 7021L	ORP test solution, 240 mV @20°C, 500 mL bottle
HI 7022L	ORP test solution, 470 mV @20°C, 500 mL bottle
HI 7091L	Reducing pretreatment solution, 500 mL bottle
HI 7092L	Oxidizing pretreatment solution, 500 mL bottle

ACCESSORIES FOR DO MEASUREMENTS

HI 7040L	Zero oxygen solution, 500 mL bottle
HI 7042S	Electrolyte solution for DO sensor, 30 mL bottle
HI 76409A/P	Spare membrane with O-ring (5 pcs)

CONDUCTIVITY STANDARD SOLUTIONS

HI 7030L	12880 $\mu\text{S}/\text{cm}$ standard solution, 500 mL bottle
HI 7031L	1413 $\mu\text{S}/\text{cm}$ standard solution, 500 mL bottle
HI 7033L	84 $\mu\text{S}/\text{cm}$ standard solution, 500 mL bottle
HI 7034L	80000 $\mu\text{S}/\text{cm}$ standard solution, 500 mL bottle
HI 7035L	111800 $\mu\text{S}/\text{cm}$ standard solution, 500 mL bottle
HI 7039L	5000 $\mu\text{S}/\text{cm}$ standard solution, 500 mL bottle

PROBE CLEANING & MAINTENANCE SOLUTIONS

HI 70670L	Cleaning solution for salt deposits, 500 mL bottle
HI 70671L	Cleaning and disinfection solution for algae, fungi and bacteria, 500 mL bottle
HI 70300L	Electrode storage solution, 500 mL

APPENDIX C - WARRANTY

All HANNA instruments® meters are guaranteed for two years (sensors, electrodes and probes for six months) against defects in workmanship and materials when used for their intended purpose and maintained according to instructions.

This warranty is limited to repair or replacement free of charge. Damage due to accident, misuse, tampering or lack of prescribed maintenance are not covered.

If service is required, contact the dealer from whom you purchased the instrument. If under warranty, report the model number, date of purchase, serial number and the nature of the failure.

If the repair is not covered by the warranty, you will be notified of the charges incurred.

If the instrument is to be returned to HANNA instruments®, first obtain a Returned Goods Authorization number from the Customer Service department and then send it with shipping costs prepaid.

When shipping any instrument, make sure it is properly packaged for complete protection.

Recommendations for Users

Before using this product, make sure that it is entirely suitable for the environment in which it is used. Operation of this instrument in residential areas could cause unacceptable interferences to radio and TV equipment, requiring the operator to take all necessary steps to correct interferences. The glass bulb at the end of the electrode is sensitive to electrostatic discharges. Avoid touching this glass bulb at all time. To maintain the EMC performance of equipment, the recommended cables noted in the user's manual must be used. Any variation introduced by the user to the supplied equipment may degrade the instruments' EMC performance. To avoid electrical shock, do not use these instruments when voltage at the measurement surface exceed 24Vac or 60Vdc. To avoid damage or burns, do not perform any measurement in microwave ovens.

SALES AND TECHNICAL SERVICE CONTACTS

Australia:	Tel. (03) 9769.0666 • Fax (03) 9769.0699
China:	Tel. (10) 88570068 • Fax (10) 88570060
Egypt:	Tel. & Fax (02) 2758.683
Germany:	Tel. (07851) 9129-0 • Fax (07851) 9129-99
Greece:	Tel. (210) 823.5192 • Fax (210) 884.0210
Indonesia:	Tel. (21) 4584.2941 • Fax (21) 4584.2942
Japan:	Tel. (03) 3258.9565 • Fax (03) 3258.9567
Korea:	Tel. (02) 2278.5147 • Fax (02) 2264.1729
Malaysia:	Tel. (603) 5638.9940 • Fax (603) 5638.9829
Singapore:	Tel. 6296.7118 • Fax 6291.6906
South Africa:	Tel. (011) 615.6076 • Fax (011) 615.8582
Taiwan:	Tel. 886.2.2739.3014 • Fax 886.2.2739.2983
Thailand:	Tel. 66-2619-0708 • Fax 66-2619-0061
United Kingdom:	Tel. (01525) 850.855 • Fax (01525) 853.668
USA:	Tel. (401) 765.7500 • Fax (401) 765.7575

For e-mail contacts and complete list of Sales and Technical offices, please see **www.hannainst.com**