

**UDC3500
Universal Digital Controller
Product Manual**

51-52-25-120

March 2007

Notices and Trademarks

Copyright 2007 by Honeywell
Revision 3
March 2007

WARRANTY/REMEDY

Honeywell warrants goods of its manufacture as being free of defective materials and faulty workmanship. Contact your local sales office for warranty information. If warranted goods are returned to Honeywell during the period of coverage, Honeywell will repair or replace without charge those items it finds defective. The foregoing is Buyer's sole remedy and is **in lieu of all other warranties, expressed or implied, including those of merchantability and fitness for a particular purpose**. Specifications may change without notice. The information we supply is believed to be accurate and reliable as of this printing. However, we assume no responsibility for its use.

While we provide application assistance personally, through our literature and the Honeywell web site, it is up to the customer to determine the suitability of the product in the application.

Honeywell Process Solutions Industrial Measurement and Control

512 Virginia Drive
Fort Washington, PA 19034

UDC3500 is a U.S. registered trademark of Honeywell

Other brand or product names are trademarks of their respective owners.

About This Document

Abstract

This document provides descriptions and procedures for the Installation, Configuration, Operation, and Troubleshooting of your UDC3500 Controller.

Contacts

World Wide Web

The following lists Honeywell's World Wide Web sites that will be of interest to our customers.

Honeywell Organization	WWW Address (URL)
Corporate	http://www.honeywell.com
Industrial Measurement and Control	http://www.honeywell.com/ps
Technical tips	http://content.honeywell.com/ipc/faq







Telephone

Contact us by telephone at the numbers listed below.

	Organization	Phone Number
United States and Canada	Honeywell	1-800-423-9883 Tech. Support 1-800-525-7439 Service

Symbol Definitions

The following table lists those symbols used in this document to denote certain conditions.

Symbol	Definition
	This CAUTION symbol on the equipment refers the user to the Product Manual for additional information. This symbol appears next to required information in the manual.
	WARNING PERSONAL INJURY: Risk of electrical shock. This symbol warns the user of a potential shock hazard where HAZARDOUS LIVE voltages greater than 30 Vrms, 42.4 Vpeak, or 60 VDC may be accessible. Failure to comply with these instructions could result in death or serious injury.
	ATTENTION, Electrostatic Discharge (ESD) hazards. Observe precautions for handling electrostatic sensitive devices
	Protective Earth (PE) terminal. Provided for connection of the protective earth (green or green/yellow) supply system conductor.
	Functional earth terminal. Used for non-safety purposes such as noise immunity improvement. NOTE: This connection shall be bonded to protective earth at the source of supply in accordance with national local electrical code requirements.
	Earth Ground. Functional earth connection. NOTE: This connection shall be bonded to Protective earth at the source of supply in accordance with national and local electrical code requirements.
	Chassis Ground. Identifies a connection to the chassis or frame of the equipment shall be bonded to Protective Earth at the source of supply in accordance with national and local electrical code requirements.

Contents

1	INTRODUCTION	1
1.1	Overview.....	1
1.2	Operator Interface	6
1.2.1	Function of Displays and Keys	7
1.3	Process Instrument Explorer Software.....	8
1.4	CE Conformity (Europe).....	10
2	INSTALLATION.....	11
2.1	Overview.....	11
2.2	Condensed Specifications	13
2.3	Model Number Interpretation	17
2.4	Control and Alarm Relay Contact Information.....	19
2.5	Mounting.....	20
2.6	Wiring	22
2.6.1	Electrical Considerations	22
2.7	Wiring Diagrams.....	24
3	CONFIGURATION.....	44
3.1	Overview.....	44
3.2	Configuration Prompt Hierarchy	46
3.3	Configuration Procedure.....	50
3.4	Loop 1 Tuning Set Up Group	51
3.5	Loop 2 Tuning Set Up Group	55
3.6	SP Ramp Set Up Group	58
3.7	SP Program 2 Set Up Group	64
3.8	SP Program 3 Set Up Group	67
3.9	SP Program 4 Set Up Group	70
3.10	Accutune Set Up Group	73
3.11	Algorithm Set Up Group	78
3.12	Math Set Up Group	93
3.13	Logic Gates Set Up Group	99
3.14	Output Set Up Group.....	106
3.15	Input 1 Set Up Group	117
3.16	Input 2 Set Up Group	121
3.17	Input 3 Set Up Group	124
3.18	Input 4 Set Up Group	127

3.19	Input 5 Set Up Group	130
3.20	Control Set Up Group	133
3.21	Control 2 Set Up Group	142
3.22	Options Set Up Group	149
3.23	Communications Set Up Group.....	161
3.24	Alarms Set Up Group	165
3.25	Real Time Clock Set Up Group.....	173
3.26	Maintenance Set Up Group	174
3.27	Display Set Up Group	177
3.28	Read Maintenance Set Up Group.....	179
3.29	Time Events Set Up Group	180
3.30	P.I.E. Tool Ethernet and Email Configuration Screens.....	182
3.31	Configuration Record Sheet	185
4	MONITORING AND OPERATING THE CONTROLLER.....	193
4.1	Overview	193
4.2	Operator Interface	194
4.3	Entering a Security Code	194
4.4	Lockout Feature	195
4.5	Monitoring Your Controller.....	197
4.5.1	Annunciators	197
4.5.2	Viewing the operating parameters.....	198
4.5.3	Diagnostic Messages.....	199
4.6	Start Up Procedure for Operation	200
4.7	Control Modes	201
4.7.1	Mode Definitions	201
4.7.2	What happens when you change modes.....	202
4.8	Setpoints.....	202
4.9	Timer.....	204
4.10	Accutune III.....	205
4.10.1	Tune for Simplex Outputs	207
4.10.2	Tune for Duplex (Heat/Cool)	208
4.10.3	Using AUTOMATIC TUNE at start-up for Duplex (Heat/Cool).....	209
4.10.4	Using BLENDED TUNE at start-up for Duplex (Heat/Cool).....	210
4.10.5	Using MANUAL TUNE at start-up for Duplex (Heat/Cool).....	211
4.10.6	ACCUTUNE Error Codes	212
4.11	Fuzzy Overshoot Suppression.....	213
4.12	Using Two Sets of Tuning Constants.....	214
4.13	Input Math Algorithms.....	216
4.14	Logic Gate Operation	218
4.15	Digital Input Option (Remote Switching).....	221

4.16	Auto/Manual Station	226
4.17	Two Loops of Control	230
4.18	Configuring Two Loops of Control.....	233
4.19	Monitoring Two Loops of Control.....	234
4.20	Operating Two Loops of Control	235
4.21	Alarm Setpoints.....	236
4.22	Three Position Step Control Algorithm.....	238
4.23	Setting a Failsafe Output Value for Restart After a Power Loss.....	239
4.24	Setting Failsafe Mode.....	240
4.25	Carbon Potential, Oxygen and Dewpoint Algorithms.....	240
4.26	Healthwatch.....	243
4.27	Setpoint Rate/Ramp/Program Overview	243
4.28	Setpoint Rate	244
4.29	Setpoint Ramp	244
4.30	Setpoint Ramp/Soak Programming	246
4.31	P.I.E. Tool Maintenance Screens	261
4.32	Configuring your Ethernet Connection	271
5	INPUT CALIBRATION.....	277
5.1	Overview.....	277
5.2	Minimum and Maximum Range Values	278
5.3	Preliminary Information.....	280
5.4	Input Set Up Wiring.....	282
5.4.1	Thermocouple Inputs Using an Ice Bath.....	282
5.4.2	Thermocouple Inputs Using a Thermocouple Source.....	283
5.4.3	RTD Inputs.....	284
5.4.4	Radiamatic, Millivolts, Volts, Carbon, Oxygen or Thermocouple Differential Inputs.....	285
5.4.5	0 to 10 Volts or -1 to 1 Volts.....	287
5.4.6	Milliamperes	288
5.4.7	Dual High Level Voltage Inputs	289
5.4.8	Dual High Level Milliamperes Inputs.....	290
5.5	Input Calibration Procedure	291
5.6	Restore Input Factory Calibration.....	293
6	OUTPUT CALIBRATION.....	295
6.1	Overview.....	295
6.2	First Current Output Calibration	296
6.3	Second Current Output Calibration.....	298
6.4	Third Current Output Calibration	300
6.5	Position Proportional and Three Position Step Output Calibration	302
6.6	Restore Factory Output Calibration	305

7	TROUBLESHOOTING/SERVICE.....	307
7.1	Overview.....	307
7.2	Troubleshooting Aids.....	308
7.3	Power-up Tests.....	310
7.4	Status Tests	310
7.5	Background Tests and Diagnostic Messages	311
7.6	Controller Failure Symptoms.....	316
7.7	Troubleshooting Procedures	317
7.7.1	Procedure #1 – Power	318
7.7.2	Procedure #2 – Current Outputs.....	318
7.7.3	Procedure #3 – Position Proportional	320
7.7.4	Procedure #4 – Time Proportional	323
7.7.5	Procedure #5 – Current/Time or Time Current/Proportional.....	324
7.7.6	Procedure #6 – Alarm Relays	325
7.7.7	Procedure #7 – Keyboard.....	326
7.7.8	Procedure #8 – Analog Input	327
7.7.9	Procedure #9 – RS-485	328
7.7.10	Procedure #10 – Ethernet	330
7.7.11	Procedure #11 – Email	331
7.8	Restoring Factory Configuration	332
7.9	Software Upgrades.....	333
8	PARTS LIST	335
8.1	Exploded View.....	335
8.2	Removing the chassis.....	337
9	MODBUS RTU FUNCTION CODES.....	338
9.1	Overview.....	338
9.2	General Information.....	338
9.3	Function Code 20 (14h) - Read Configuration Reference Data.....	340
9.3.1	Read Configuration Examples	342
9.4	Function Code 21 (15h) - Write Configuration Reference Data.....	344
9.4.1	Write Configuration Examples	346
10	MODBUS READ, WRITE AND OVERRIDE PARAMETERS PLUS EXCEPTION CODES.....	347
10.1	Overview	347
10.2	Reading Control Data.....	350
10.3	Read Software Options Status.....	351
10.4	Miscellaneous Read Onlys	352
10.4.1	Register Addresses for Read Onlys	352
10.4.2	SetPoint Program Read Only Information.....	352

10.5	Setpoints	353
10.6	Using a Computer Setpoint (Overriding Controller Setpoint)	355
10.7	Configuration Parameters	358
10.7.1	Tuning Loop 1	358
10.7.2	Tuning Loop2	360
10.7.3	SP Ramp/Rate/Program #1	361
10.7.4	Setpoint Program #2	367
10.7.5	Setpoint Program #3	373
10.7.6	Setpoint Program #4	379
10.7.7	Accutune	385
10.7.8	Algorithm	387
10.7.9	Math	392
10.7.10	Logic	395
10.7.11	Output Algorithms	399
10.7.12	Input 1	401
10.7.13	Input 2	403
10.7.14	Input 3	405
10.7.15	Input 4	407
10.7.16	Input 5	409
10.7.17	Control	411
10.7.18	Control Loop 2	414
10.7.19	Options	417
10.7.20	Communications	421
10.7.21	Alarms	423
10.7.22	Maintenance	427
10.7.23	Time Event	430
10.7.24	Display	432
10.7.25	Clock	433
10.8	Modbus RTU Exception Codes	434
11	FURTHER INFORMATION	436
11.1	Modbus RTU Serial Communications	436
11.2	Modbus Messaging on Ethernet TCP/IP	436
11.3	How to Apply Digital Instrumentation in Severe Electrical Noise Environments	436
12	INDEX	437
13	SALES AND SERVICE	442

Tables

Table 2-1 Condensed Specifications	13
Table 2-2 Control Relay Contact Information	19
Table 2-3 Alarm Relay Contact Information	19
Table 2-4 Mounting Procedure	21
Table 2-5 Permissible Wiring Bundling	23
Table 2-6 Single or Cascade Loop Controller – Loop 1 Output Functionality and Restrictions	25
Table 2-7 Dual Loop Controller – Loop 2 Output Functionality and Restrictions	26
Table 2-8 Terminals for connecting a UDC to a MDI Compliant Hub or Switch utilizing a cross-over cable	40
Table 2-9 Terminals for connecting a UDC directly to a PC utilizing a straight-through cable	41
Table 3-1 Configuration Topics	44
Table 3-2 Configuration Prompt Hierarchy	46
Table 3-3 Configuration Procedure	50
Table 3-4 TUNING Group Function Prompts	51
Table 3-5 TUNING 2 Group Function Prompts	55
Table 3-6 SPRAMP Group Function Prompts	59
Table 3-7 SP PROG2 Group Function Prompts	64
Table 3-8 SP PROG3 Group Function Prompts	67
Table 3-9 SP PROG4 Group Function Prompts	70
Table 3-10 ACCUTUNE Group Function Prompts	74
Table 3-11 ALGORITHM Group Function Prompts	78
Table 3-12 MATH Group Function Prompts	93
Table 3-13 LOGIC Group Function Prompts	99
Table 3-14 OUTPUT Group Function Prompts	106
Table 3-15 INPUT 1 Group Function Prompts	117
Table 3-16 INPUT 2 Group Function Prompts	121
Table 3-17 INPUT 3 Group Function Prompts	124
Table 3-18 INPUT 4 Group Function Prompts	127
Table 3-19 INPUT 5 Group Function Prompts	130
Table 3-20 CONTROL Group Function Prompts	133
Table 3-21 CONTROL2 Group Function Prompts	142
Table 3-22 OPTION Group Function Prompts	149
Table 3-23 Communications Group Function Prompts	161
Table 3-24 ALARMS Group Function Prompts	166
Table 3-25 CLOCK Group Function Prompts	173
Table 3-26 MAINTENANCE Group Function Prompts	174
Table 3-27 DISPLAY Group Function Prompts	177
Table 3-28 READ MAINTENANCE Group Function Prompts	179
Table 3-29 TIME EVT Group Function Prompts	180
Table 3-30 Configuration Record Sheet	185
Table 4-1 Procedure to Enter a Security Code	195
Table 4-2 Annunciators	197
Table 4-3 Lower Display Key Parameter Prompts	198
Table 4-4 Procedure for Starting Up the Controller	200
Table 4-5 Control Mode Definitions	201
Table 4-6 Changing Control Modes	202
Table 4-7 Procedure for Changing the Local Setpoints	203
Table 4-8 Procedure for Switching Between Setpoints	203

Table 4-9 Procedure for Starting “TUNE”	207
Table 4-10 Procedure for Using AUTOMATIC TUNE at Start-up for Duplex Control	209
Table 4-11 Procedure for Using BLENDED TUNE at Start-up for Duplex Control	210
Table 4-12 Procedure for Using MANUAL TUNE for Heat side of Duplex Control	211
Table 4-13 Procedure for Using MANUAL TUNE for Cool side of Duplex Control	211
Table 4-14 Procedure for Accessing Accutune Error Codes	212
Table 4-15 Accutune Error Codes	212
Table 4-16 Set Up Procedure	214
Table 4-17 Procedure for Switching PID SETS from the Keyboard	215
Table 4-18 Logic Gates Constraints and Dynamic Operation Status	219
Table 4-19 Digital Input Option Action on Contact Closure	221
Table 4-20 Digital Input Combinations “DIG IN1” or “DIG IN2”	224
Table 4-21 Digital Inputs 1 and 2 Combination	225
Table 4-22 Auto/Manual Station Mode Configuration Procedure	227
Table 4-23 Procedure for selecting Two Loop Algorithm	233
Table 4-24 Digital Display Indication—Two Loops	234
Table 4-25 Procedure for Displaying Alarm Setpoints	236
Table 4-26 Procedure for Displaying TPSC Motor Position	238
Table 4-27 Procedure for Setting a Failsafe Value	239
Table 4-28 Procedure for Setting a Failsafe Mode	240
Table 4-29 Running A Setpoint Ramp	245
Table 4-30 Program Contents	247
Table 4-31 Ramp/Soak Profile Example (Using 12 Segments)	250
Table 4-32 Program #1 Record Sheets	251
Table 4-33 Program #2 Record Sheets	253
Table 4-34 Program #3 Record Sheets	255
Table 4-35 Program #4 Record Sheets	257
Table 4-36 Run/Monitor Functions	259
Table 5-1 Voltage, Milliamp and Resistance Equivalents for Input Range Values	278
Table 5-2 Equipment Needed	280
Table 5-3 Set Up Wiring Procedure for Thermocouple Inputs Using an Ice Bath	282
Table 5-4 Set Up Wiring Procedure for Thermocouple Inputs using a Thermocouple Source	283
Table 5-5 Set Up Wiring Procedure for RTD Inputs	284
Table 5-6 Set Up Wiring Procedure for Radiamatic, Millivolts, Volts, Carbon, Oxygen or Thermocouple Differential Inputs (Except 0-10 Volts and –1 to 1 Volts)	285
Table 5-7 Procedure to determine calibration voltages for Thermocouple Differential input types other than the Factory Setting	286
Table 5-8 Set Up Wiring Procedure for 0 to 10 Volts or –1 to 1 Volts	287
Table 5-9 Set Up Wiring Procedure for Milliampere Inputs	288
Table 5-10 Set Up Wiring Procedure for Dual High Level Voltage Inputs	289
Table 5-11 Set Up Wiring Procedure for Dual High Level Milliampere Inputs	290
Table 5-12 Input Calibration Procedure	291
Table 5-13 Restore Factory Calibration	293
Table 6-1 Set Up Wiring Procedure for the First Current Output	296
Table 6-2 First Current Output Calibration Procedure	297
Table 6-3 Set Up Wiring Procedure for the Second Current Output	298
Table 6-4 Second Current Output Calibration Procedure	299
Table 6-5 Set Up Wiring Procedure for the Third Current Output	300
Table 6-6 Third Current Output Calibration Procedure	301
Table 6-7 Position Proportional and Three Position Step Output Calibration Procedure	303

Table 6-8 Restore Factory Calibration	305
Table 7-1 Procedure for Identifying the Software Version	309
Table 7-2 Procedure for Displaying the Status Test Results	310
Table 7-3 Background Tests	311
Table 7-4 Controller Failure Symptoms	316
Table 7-5 Troubleshooting Power Failure Symptoms	318
Table 7-6 Troubleshooting Current Output Failure	318
Table 7-7 Troubleshooting Position Proportional Output Failure	320
Table 7-8 Troubleshooting Time Proportional Output Failure	323
Table 7-9 Troubleshooting Current/Time or Time/Current Proportional Output Failure	324
Table 7-10 Troubleshooting Alarm Relay Output Failure	325
Table 7-11 Troubleshooting a Keyboard Failure	326
Table 7-12 Troubleshooting an Analog Input Failure	327
Table 7-13 Troubleshooting a RS-485 Communications Failure	328
Table 7-14 Troubleshooting an Ethernet Communications Failure	330
Table 7-15 Troubleshooting an Email Failure	331
Table 7-16 Restoring Factory Configuration	332
Table 7-17 Software Upgrades	333
Table 8-1 Parts Identification	336
Table 8-2 Parts Not Shown	336
Table 8-3 Software Upgrades (see Section 7.9)	337
Table 9-1 Integer Parameter Type	339
Table 9-2 Floating Point Parameter Type	339
Table 9-3 Register Parameter ID Address Format for Function Code 20	341
Table 9-4 Register Parameter ID Address Format for Function Code 21	345
Table 10-1 Control Data Parameters	350
Table 10-2 Option Status	351
Table 10-3 Miscellaneous Read Onlys	352
Table 10-4 SetPoint Program Read Only Information	352
Table 10-5 Setpoint Code Selections	353
Table 10-6 Setpoint Associated Parameters	354
Table 10-7 Computer Setpoint Selection	355
Table 10-8 Computer Setpoint Associated Parameters for Loop 1	356
Table 10-9 Computer Setpoint Associated Parameters for Loop2	357
Table 10-10 Set-up Group – Tuning Loop 1	358
Table 10-11 Set-up Group – Tuning Loop 2	360
Table 10-12 Set-up Group – Setpoint Ramp/Rate/Program #1	361
Table 10-13 Set-up Group – Setpoint Program #2	367
Table 10-14 Set-up Group – Setpoint Program #3	373
Table 10-15 Set-up Group – Setpoint Program #4	379
Table 10-16 Set-up Group – Adaptive Tune	385
Table 10-17 Set-up Group – Algorithm	387
Table 10-18 Set-up Group – Math	392
Table 10-19 Set-up Group – Logic	395
Table 10-20 Set-up Group – Output Algorithms	399
Table 10-21 Set-up Group – Input 1	401
Table 10-22 Set-up Group – Input 2	403
Table 10-23 Set-up Group – Input 3	405
Table 10-24 Set-up Group – Input 4	407
Table 10-25 Set-up Group – Input 5	409

Table 10-26	Set-up Group – Control	411
Table 10-27	Set-up Group – Control2	414
Table 10-28	Set-up Group – Options	417
Table 10-29	Set-up Group – Communications	421
Table 10-30	Set-up Group – Alarms	423
Table 10-31	Set-up Group – Maintenance	427
Table 10-32	Set-up Group – Time Event	430
Table 10-33	Set-up Group – Display	432
Table 10-34	Set-up Group – Clock	433
Table 10-35	Modbus RTU Data Layer Status Exception Codes	435

Figures

Figure 1-1 UDC3500 Operator Interface	6
Figure 1-2 Screen capture of Process Instrument Explorer running on a Pocket PC	8
Figure 1-3 Depiction of infrared communications	9
Figure 2-1 Model Number Interpretation	18
Figure 2-2 Mounting Dimensions (not to scale)	20
Figure 2-3 Mounting Methods	21
Figure 2-4 Composite Wiring Diagram	27
Figure 2-5 Mains Power Supply	28
Figure 2-6 Input 1 Connections	29
Figure 2-7 Input 2 Connections	30
Figure 2-8 Input 3 Connections	31
Figure 2-9 HLAI Inputs 2 and 4 Connections	32
Figure 2-10 HLAI Inputs 3 and 5 Connections	33
Figure 2-11 Optional Analog Input Jumper Positions	33
Figure 2-12 First Current Output	34
Figure 2-13 Second Current Output	34
Figure 2-14 Output #2 – Electromechanical Relay Output	35
Figure 2-15 Output #2 – Solid State Relay Output	35
Figure 2-16 Output #2 – Open Collector Output- Third	36
Figure 2-17 Output #2 – Third Current Output	36
Figure 2-18 Output #2 – Dual Relay Output for Time Duplex	37
Figure 2-19 Output #2 – Dual Relay Output for Position Proportional or Three Position Step Control	37
Figure 2-20 RS-422/485 Communications Option Connections	38
Figure 2-21 Ethernet Communications Option with Adaptor Board	38
Figure 2-22 Ethernet Communications Option without Adaptor Board	39
Figure 2-23 Digital Inputs	41
Figure 2-24 Optional Electromechanical Relay Outputs	42
Figure 2-25 Transmitter Power for 4-20 mA — 2 wire Transmitter Using Open Collector Output	42
Figure 2-26 Transmitter Power for 4-20 mA — 2 Wire Transmitter Using Second Current Output	43
Figure 3-1 Mass Flow Example	91
Figure 3-2 Example of Eight Segment Characterizer	98
Figure 3-3 Ethernet Configuration Screen	182
Figure 3-4 Email Configuration Screen	183
Figure 4-1 Operator Interface	194
Figure 4-2 Auto/Manual Station for Loop 1 (Loop 2 similar)	226
Figure 4-3 Functional Overview Block Diagram of a Single Loop (Loop #1) or Dual Loop Controller (Loop #1 and Loop #2)	231
Figure 4-4 Functional Overview Block Diagram of Internal Cascade Controller	232
Figure 4-5 Hi/Lo Override Selector	233
Figure 4-6 Carbon Potential Control	242
Figure 4-7 Ramp/Soak Profile Example	250
Figure 4-8 SP Program #1 Record Sheets	251
Figure 4-9 SP Program #2 Record Sheets	253
Figure 4-10 SP Program #3 Record Sheets	255
Figure 4-11 SP Program #4 Record Sheets	257
Figure 4-12 Loop Data Maintenance Screen	261
Figure 4-13 Alarm Details Maintenance Screen	262
Figure 4-14 Digital Inputs Details Maintenance Screen	263

Figure 4-15	Status Data Maintenance Screen	264
Figure 4-16	Diagnostic History Maintenance Screen	265
Figure 4-17	Ethernet Status Maintenance Screen	266
Figure 4-18	Healthwatch Data Maintenance Screen	267
Figure 4-19	Healthwatch Data Reset Screen	268
Figure 4-20	Totalizer Maintenance Screen	269
Figure 4-21	Real Time Clock Maintenance Screen	270
Figure 4-22	IR Communications Address	271
Figure 4-23	Configuration Upload in Progress	272
Figure 4-24	Ethernet Communications Address	274
Figure 4-25	Configuration Upload in Progress	275
Figure 5-1	Input Wiring Terminals	280
Figure 5-2	Wiring Connections for Thermocouple Inputs Using an Ice Bath	282
Figure 5-3	Wiring Connections for Thermocouple Inputs Using a Thermocouple Source	283
Figure 5-4	Wiring Connections for RTD (Resistance Thermometer Device)	284
Figure 5-5	Wiring Connections for Radiamatic, Millivolts, Volts, Carbon, Oxygen or Thermocouple Differential Inputs (Except 0-10 Volts and -1 to 1 Volts)	285
Figure 5-6	Wiring Connections for 0 to 10 Volts or -1 to 1 Volts	287
Figure 5-7	Wiring Connections for Milliampere Inputs	288
Figure 5-8	Wiring Connections for Dual High Level Voltage Inputs	289
Figure 5-9	Wiring Connections for Dual High Level Milliampere Inputs	290
Figure 6-1	Wiring Connections for Calibrating the First Current Output	296
Figure 6-2	Wiring Connections for Calibrating the Second Current Output	298
Figure 6-3	Wiring Connections for Calibrating Third Current Output	300
Figure 8-1	UDC3500 Exploded View	335
Figure 10-1	Software Option Status Information	351

1 Introduction

1.1 Overview

Function

The UDC3500 is a microprocessor-based stand-alone controller. It combines a high degree of functionality and operating simplicity in a 1/4 DIN size controller. This instrument is an ideal controller for regulating temperature and other process variables in numerous heating and cooling applications, as well as in metal working, food, pharmaceuticals, semiconductor, testing and environmental work.

The UDC3500 monitors and controls temperatures and other variables in applications such as environmental chambers, plastic processing machines, furnaces and ovens, and packaging machinery.

Features

- 3 Universal Analog Inputs (can be configured to act as one Universal and four High Level)
- $\pm 0.10\%$ Analog Input Accuracy (can be Field Calibrated to $\pm 0.05\%$)
- 16-bit Analog Input resolution typical
- Fast scanning rate (166ms)
- Up to 7 Analog and Digital Outputs
- 4 Digital Inputs
- Two Math Functions, two Characterizers, one Polynomial equation and one Totalizer available
- Two Independent Loops or Cascade Loop
- Up to four 20-segment Setpoint Programs (can be concatenated to form two 40-segment Setpoint Programs)
- Ethernet TCP/IP with Email or RS-485 Modbus communication
- Infrared PC & Pocket PC configuration
- NEMA4X and IP66 front face protection
- Multilanguage prompts
- 1/4 DIN Size
- Easily Field Upgradeable

Easy to read displays

Bright, dual displays with multi-language prompts (in English, French, German, Spanish, or Italian) make the operator interface easy to read, understand, and operate. Simple keystrokes let you set operating parameters that meet your process control needs.

Analog Inputs

The UDC3500 has three universal analog inputs with a typical accuracy of $\pm 0.10\%$ of full-scale input and a typical resolution of 16 bits. These can be configured to act as one Universal and four High Level Inputs for a total of five analog inputs. All analog inputs are sampled six times per second (every 166 ms).

The Process Variable input can be one of the various Thermocouple, RTD, Radiamatic or linear actuations. Linear actuations have Thermocouple, RTD, and Radiamatic transmitter characterization capability as a standard feature. Linear actuations also have square root capability.

The optional second and third inputs are isolated from each other and all other inputs and outputs and accept the same actuations as input one. Input 3 provides the Slidewire input for Position Proportional control. These optional inputs can each be split into two high level inputs. The fourth input is enabled by first configuring Input 2 as a 20 mA or 5 Vdc input type (high level) and moving a jumper on the Second Optional Input Board. Input 4 will then be available as a high level input. The fifth input is enabled by first configuring Input 3 as a 20 mA or 5 Vdc input type (high level) and moving a jumper on the Third Optional Input Board. Input 5 will then be available as a high level input.

All actuations and characterizations are keyboard configurable. Cold junction compensation is provided for thermocouple type inputs. Upscale, downscale or failsafe sensor break protection is keyboard configurable. A configurable digital filter of 0 to 120 seconds provides input signal damping.

Thermocouple Health—In addition to the standard configurable upscale, downscale or failsafe output burnout selections, the condition of the thermocouple can be monitored to determine if it is good, failing or in danger of imminent failure.

Math Functions

Algorithm—Two pre-configured algorithms are available for easy implementation. This includes the capability of using a Ratio and Bias with any input. You can select from the following menu:

Feedforward Summer—Uses any input, followed by a Ratio/Bias calculation, summed directly with the computed PID output value to provide a resultant output to the final control element (standard feature).

Weighted Average —Computes the weighted average of a PV or SP for the control algorithm from two inputs (standard feature).

Feedforward Multiplier—Uses any input, multiplied by the calculated PID output to provide a resultant output, which is sent to the final control element (standard feature).

Summer/Subtractor—Will add or subtract inputs with the result used as the derived PV.

Multiplier/Divider—Uses the analog inputs to calculate a derived PV. It is available with or without Square Root.

Input High/Low Select—Specifies the PV input as the higher or lower of two inputs.

8 Segment Characterizers—Two characterizers are available that can be applied to any Analog Input, to Loop 1 Output or to Loop 2 Output. The Characterizers can be combined to produce a single 16-segment characterizer. †

Totalizer—Calculates and displays the total flow volume as measured by any of the analog inputs or as derived by either Math algorithm. Displayed value is eight digits with a configurable scaling factor. The totalizer value may be reset.

Combinational Inputs—Inputs can be combined for use with Relative Humidity, % Oxygen, Carbon Potential, Dewpoint or Math Algorithms. This controller can accept carbon probes from Cambridge, Marathon Monitors, Corning, A.A.A.C, Barber Coleman, MacDhui, Bricesco or Furnace Controls.

Polynomial Curve Characterizer—A fifth order polynomial equation can be used on any one of the analog inputs.

Logic Gates—Five Logic Gates configurable as OR, NOR, AND, NAND, XOR, XNOR, or COMPARATOR. Each Gate has two inputs and one output. The Gates may be linked together to perform more complex functions.

† Characterizers are mutually exclusive with Setpoint Program #4.

Digital Inputs

Four isolated digital inputs are provided for remote dry contact closure to select one of 25 actions. Also, two of these digital inputs can allow one of six additional selections to be combined with one of the above selections.

Outputs

Output Types - The UDC3500 may have up to seven of the following outputs:

- Current Outputs (4-20 or 0-20 mA)
- Electromechanical Relays (5 amps)
- Solid State Relay (1 amp)
- Dual Electromechanical Relays (2 amps)
- Open Collector Output (+30 VDC @ 20 mA)

Alarms

Up to four electromechanical alarm relays are available to activate external equipment when preset alarm setpoints are reached. Each of the four alarms can be set to monitor two independent setpoints. Each alarm setpoint can be either high or low alarm. The alarm type can be selected to be either of the inputs, the Process Variable, Deviation, Output, Shed from communications, PV rate of change, or to alarm on manual mode activation or a Current Output Open failure. It can also be used as an On or Off event at the beginning or end of a Ramp/Soak segment. An individual alarm hysteresis setting is provided for each relay and these are configurable from 0 to 100% of range.

- Alarms can be configured as latching or non-latching. *continued*

- Alarm blocking is also available which allows start-up without alarm energized until after it first reaches the operating region.
- PV rate of change alarm.
- Loop break alarm.
- Timer output reset.
- Diagnostic Alarm

Communications

A communications link is provided between the UDC3500 and a host computer or PLC via the RS422/485 Modbus® RTU or Ethernet TCP/IP * communications option. An infrared communication link is also available allowing a non-intrusive configuration of the instrument.

Miscellaneous Features

Auxiliary Output * (optional)—All of the three current outputs can function as Auxiliary Outputs which can be scaled from 4-20 ma for 0 to 100% for any range. These can be configured to represent any analog input, PV, active Setpoint, Local SP1, Deviation, or the Control Output for either control loop.

Transmitter Power—This feature provides up to 30 volts dc to power a 2-wire transmitter (requires the use of open collector output selection or one of the current outputs).

Four Local and one Remote Setpoints—Can be configured to provide four Local and one Remote Setpoints, which are selectable either via the keyboard or by Digital Input.

Universal Switching Power—Operates on any line voltage from 90 to 264 Vac 50/60 Hz without jumpers. 24 Vac/dc instrument power is available as an option.

Timer—This standard feature provides a configurable time period of 0 to 99 hours, 59 minutes or units of minutes and seconds. It can be started via the keyboard, alarm 2, or by a digital input. The timer output is Alarm 1, which energizes at the end of the Timer Period. Alarm 1 can be automatically reset. The Timer Period can be changed between each batch. Status is shown on the lower display.

Healthwatch—Consists of three timers and three counters, which can each be assigned to track UDC3500 controller functions. Selected Maintenance & Diagnostic data can be accessed from the front panel or via communications. Alarms can be configured to activate when a desired threshold is reached. A security code is required to perform resetting of any of the above listed counter or timer functions.

Real Time Clock—An optional battery-backed clock feature that allows the user to perform such things as starting an SP Program on a specific date and time.

Auto/Manual Station Plus Back-up Control—A UDC3500 can act as both an Auto/Manual Station PLUS as a back-up PID Controller, should the primary loop controller fail. Since the PID control is sometimes implemented via a PLC, this feature provides a very cost-effective way to insure the process does not have to shutdown or

remain in manual mode if the PLC should fail. Switching from the Auto/Manual Station to the back-up control mode is accomplished using the Digital Input option.

Moisture Protection—The NEMA4X and IP66 rated front face permits use in applications where it may be subjected to moisture, dust, or hose-down conditions. UL and CSA approved as Type 4 protection.

Setpoint Ramp/Soak Programming (Optional)—Enables you to program and store ten Ramp and ten Soak segments (total of twenty segments) for setpoint programming. Run or Hold of program is keyboard or remote digital switch selectable.

Enhanced Setpoint Programming (Optional)—Four Setpoint Programs each of ten Ramp and ten Soak Segments. Each pair can be concatenated so as to form a single Setpoint Program of twenty Ramps and twenty Soaks. †

Setpoint Rate—Lets you define a ramp rate to be applied to any local setpoint change. A separate upscale or downscale rate is configurable. A single setpoint ramp is also available as an alternative.

Output Rate Limiter—A maximum output rate may be configured for both the upscale and the downscale output directions.

CE Mark—Conformity with 73/23/EEC, Low Voltage Directive and 89/336/EEC, the EMC Directive as a standard feature.

Approval Body Options—CSA certification and UL listing are available as an option.

Four Sets of Tuning Constants—Four sets of PID parameters can be configured for each loop and automatically or keyboard selected.

Data Security—Five levels of keyboard security protect tuning, configuration, and calibration data, accessed by a configurable 4-digit code. Nonvolatile EEPROM memory assures data integrity during loss of power.

Diagnostic/Failsafe Outputs—Continuous diagnostic routines detect failure modes, trigger a failsafe output value and identify the failure to minimize troubleshooting time.

High Noise Immunity—The controller is designed to provide reliable, error-free performance in industrial environments that often affect highly noise-sensitive digital equipment.

Accutune III™—This standard feature provides a truly plug and play tuning algorithm, which will, at the touch of a button or through a digital input, accurately identify and tune any process including those with deadtime and integrating processes. This speeds up and simplifies start-up plus allows retuning at any setpoint. The algorithm used is an improved version of the Accutune II™ algorithm found on earlier controllers. Two possibilities are now offered when tuning your process: Fast Tune and Slow Tune.

Fast Tune will tune the process in such a way that the temp is reached faster, a slight overshoot will be allowed.

Slowtune will minimize overshoot, but it will take more time for the process temperature to reach the target setpoint.

Heat/Cool (Duplex Tune) will automatically tune both the heating and cooling sides of the process.

Fuzzy Logic—This standard feature uses fuzzy logic to suppress process variable overshoot due to SP changes or externally induced process disturbances. It operates independently from Accutune III™ tuning. It does not change the PID constants, but temporarily modifies the internal controller response to suppress overshoot. This allows more aggressive tuning to co-exist with smooth PV response. It can be enabled or disabled depending on the application or the control criteria.

* The Second Current Output option is mutually exclusive with the Ethernet Communications option.

† Characterizers are mutually exclusive with Setpoint Program #4.

1.2 Operator Interface

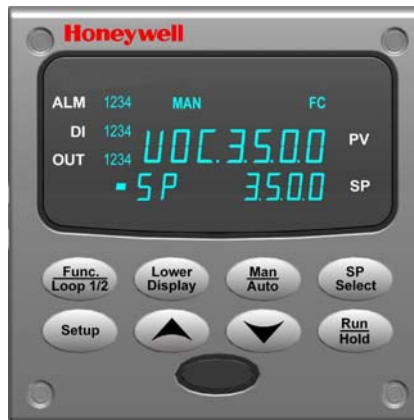











Figure 1-1 UDC3500 Operator Interface

1.2.1 Function of Displays and Keys

Table 1-1 Function of Displays and Keys

Display Indicators	
<p>3500 Upper display with 4 larger digits shows Process Variable value (normal operation) and special annunciator features. During Configuration, the upper display provides guidance for the operator through prompts (7 – characters)</p>	<p>OUT Indicates Control Relay 1 and/or 2 on.</p>
<p>SP 3500 During normal operation, the lower display shows key-selected operating parameters such as Output, Setpoints, Inputs, Deviation, active Tuning Parameter Set, Timer Status, or minutes remaining in a setpoint ramp (4 digits). During configuration, the lower display provides guidance for the operator through prompts (8-characters).</p>	<p>F Or C Indicates either degrees Fahrenheit or Centigrade.</p>
<p>ALM Indicates Alarm 1 and/or Alarm 2 conditions exist.</p>	<p>MAN Or A Indicates either Manual or Auto mode.</p>
<p>DI Indicates Digital Input 1 and/or 2 on.</p>	<p>SP Indicates Local Setpoint #1. Also, a bar is lighted when the setpoint being used is shown on the lower display.</p>

Keys and Functions

<p> Selects functions within each configuration group. Switches between Loop Displays for Two Loop and Cascade units.</p>	<p> Selects Manual or Auto mode.</p>
<p> Scrolls through the configuration groups.</p>	<p> Hold key down to cycle through configured setpoints.</p>
<p> Returns Controller to normal display from Set Up mode. Toggles various operating parameters for display.</p>	<p> Enables Run/Hold of the SP Ramp or Program plus Timer start.</p>
<p> Increases setpoint or output value. Increases the configuration values or changes functions in Configuration mode groups.</p>	<p> Decreases setpoint or output value. Decreases the configuration values or changes functions in Configuration mode groups.</p>
<p> Infrared transceiver</p>	<p> NEMA4X and IP66 screw attachment (each corner)</p>

1.3 Process Instrument Explorer Software

Overview

Process Instrument Explorer (P.I.E.) lets you configure your instrument on a desktop/laptop or Pocket PC. For details see Process Instrument Explorer Manual #51-52-25-131.

Features

- Create configurations with intuitive software program running on a Pocket PC, a Desktop or a laptop computer.
- Create/edit configurations live, just connect software to the controller via a communications port.
- Create/edit configurations offline and download to controller later via a communications port.
- Communication types available on every UDC3500:
 - Infrared (standard)
 - RS 485 (optional)
 - Ethernet (optional)
- Same port types on UDC2500 and UDC3200 allow interconnectivity.
- This software is available in English, Spanish, Italian, German and French.

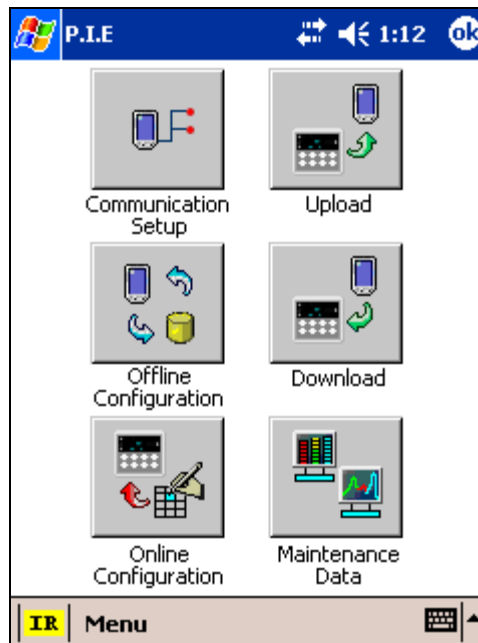

Figure 1-2 Screen capture of Process Instrument Explorer running on a Pocket PC

Infrared communications

The infrared connection provides a non-intrusive wireless connection with the instrument and maintains NEMA4X AND IP66 integrity.

No need to get access to the back of the controller to communicate with the instrument, no need to take your screw driver to wire the communication cable, no wiring mistake possible. You can now duplicate an instrument's configuration, upload or download a new configuration in a matter of seconds, just by pointing your Pocket PC in the direction of the instrument.

It takes just a few seconds to upload a configuration from an instrument. You can then save the configuration file onto your PC or pocket PC for review, modification or archiving. Furthermore, this software also gives you important maintenance information on the controller: instantly, get information on the current operating parameters, digital inputs and alarm status, identify internal or analog input problems.

Question: What if I have several controllers on the same panel? How can I be sure I am communicating with the correct one?

Answer: The infrared port of the controller is normally "off". You activate the infrared port by pressing any controller's key. You can now communicate. After 4 minutes, the port will be shut down again. Each controller may also be assigned a different communications address.



Figure 1-3 Depiction of infrared communications

1.4 CE Conformity (Europe)

This product is in conformity with the protection requirements of the following European Council Directives: **73/23/EEC**, the Low Voltage Directive, and **89/336/EEC**, the EMC Directive. Conformity of this product with any other “CE Mark” Directive(s) shall not be assumed.

Product Classification: Class I: Permanently connected, panel-mounted Industrial Control Equipment with protective earthing (grounding) (EN61010-1).

Enclosure Rating: This controller must be panel-mounted with the rear terminals enclosed within the panel. The front panel of the controller is rated at NEMA4X and IP66 when properly installed.

Installation Category (Overvoltage Category): Category II (EN61010-1)

Pollution Degree: Pollution Degree 2: Normally non-conductive pollution with occasional conductivity caused by condensation. (Ref. IEC 664-1)

EMC Classification: Group 1, Class A, ISM Equipment (EN61326, emissions), Industrial Equipment (EN61326, immunity)

Method of EMC Assessment: Technical File (TF)

Declaration of Conformity: 51453681

Deviation from the installation conditions specified in this manual, and the special conditions for CE conformity in Subsection 2.1, may invalidate this product’s conformity with the Low Voltage and **EMC** Directives.

ATTENTION

The emission limits of EN61326 are designed to provide reasonable protection against harmful interference when this equipment is operated in an industrial environment. Operation of this equipment in a residential area may cause harmful interference. This equipment generates, uses, and can radiate radio frequency energy and may cause interference to radio and television reception when the equipment is used closer than 30 meters (98 feet) to the antenna(e). In special cases, when highly susceptible apparatus is used in close proximity, the user may have to employ additional mitigating measures to further reduce the electromagnetic emissions of this equipment.

WARNING

If this equipment is used in a manner not specified by the manufacturer, the protection provided by the equipment may be impaired.

2 Installation

2.1 Overview

Introduction

Installation of the UDC3500 consists of mounting and wiring the controller according to the instructions given in this section. Read the pre-installation information, check the model number interpretation (Subsection 2.3) and become familiar with your model selections, then proceed with installation.

What's in this section?

The following topics are covered in this section.

TOPIC	See Page
2.1 Overview	11
2.2 Condensed Specifications	13
2.3 Model Number Interpretation	17
2.4 Control and Alarm Relay Contact Information	19
2.5 Mounting	20
2.6 Wiring	22
2.7 Wiring Diagrams	
Figure 2-4 Composite Wiring Diagram	27
Figure 2-5 Mains Power Supply	28
Figure 2-6 Input 1 Connections	29
Figure 2-7 Input 2 Connections	30
Figure 2-8 Input 3 Connections	31
Figure 2-9 HLAI Inputs 2 and 4	32
Figure 2-10 HLAI Inputs 3 and 5	33
Figure 2-11 Optional Analog Input Jumper Positions	33
Figure 2-12 First Current Output	34
Figure 2-13 Second Current Output	34
Figure 2-14 Output #2 – Electromechanical Relay Output	35
Figure 2-15 Output #2 – Solid State Relay Output	35
Figure 2-16 Output #2 – Open Collector Output	36
Figure 2-17 Output #2 – Third Current Output	36
Figure 2-18 Output #2 – Dual Relay Output for Time Duplex	37
Figure 2-19 Output #2 – Dual Relay Output for Position Proportional or Three Position Step Control	37
Figure 2-20 RS-422/485 Communications Option	38
	39

Figure 2-22 Ethernet Communications Option	41
Figure 2-23 Digital Inputs	42
Figure 2-24 Optional Electromechanical Relay Outputs	42
Figure 2-25 Transmitter Power for 4-20 mA — 2 wire Transmitter Using Open Collector Output	43
Figure 2-26 Transmitter Power for 4-20 mA — 2 Wire Transmitter Using Second Current Output	43

Pre-installation Information

If the controller has not been removed from its shipping carton, inspect the carton for damage then remove the controller.

- Inspect the unit for any obvious shipping damage and report any damage due to transit to the carrier.
- Make sure a bag containing mounting hardware is included in the carton with the controller.
- Check that the model number shown on the inside of the case agrees with what you have ordered.

2.2 Condensed Specifications

Honeywell recommends that you review and adhere to the operating limits listed in Table 2-1 when you install your controller.

Table 2-1 Condensed Specifications

Specifications	
Analog Inputs	<p>Up to three Universal analog inputs. These can easily be configured to operate as 2 Universal and 2 High Level or as 1 Universal and 4 High Level inputs.</p> <p><i>Accuracy:</i> $\pm 0.10\%$ of full scale typical (± 1 digit for display) Can be field calibrated to $\pm 0.05\%$ of full scale typical 16-bit resolution typical</p> <p><i>Sampling Rate:</i> All inputs are sampled six times per second</p> <p><i>Temperature Stability:</i> $\pm 0.0075\%$ of Full Scale span / °C change—typical</p> <p><i>Input Impedance:</i> 0-20 and 4-20 Milliampere Inputs: 250 ohms 0-10 Volt and -1 to +1 Volt Input: 200K ohms All Others: 10 megohms</p> <p><i>Maximum Lead Wire Resistance:</i> Thermocouples: 50 ohms/leg 100 ohm, 200 ohm, 500 ohm and 1000 ohm RTD: 100 ohms/leg 100 ohm Low RTD: 10 ohms/leg</p> <p><i>Slidewire Input for Position Proportional Control (Input 3 only):</i> 100 ohm to 1000 ohm resistive slidewire types Herculine[®] Models 10260 and 11280 Slidewire Emulation</p>
Analog Input Signal Failure Operation	<p><i>Burnout Selections:</i> Upscale, Downscale, Failsafe or None</p> <p><i>Thermocouple Health:</i> Good, Failing, Failure Imminent or Failed</p> <p><i>Failsafe Output Level:</i> Configurable 0-100% of Output range</p>
Stray Rejection	<p>Common Mode</p> <p><i>AC (50 or 60 Hz):</i> 120 dB (with maximum source impedance of 100 ohms) or ± 1 LSB (least significant bit) whichever is greater with line voltage applied.</p> <p><i>DC:</i> 120 dB (with maximum source impedance of 100 ohms) or a ± 1 LSB whichever is greater with 120 Vdc applied.</p> <p><i>DC (to 1 KHz):</i> 80 dB (with maximum source of impedance of 100 ohms) or ± 1 LSB whichever is greater with 50 Vac applied.</p> <p>Normal Mode</p> <p><i>AC (50 or 60 Hz):</i> 60 dB (with 100 % span peak-to-peak maximum)</p>
Digital Inputs (Four) (Optional)	<p>+30 Vdc source for external dry contacts or isolated solid-state contacts. Digital Inputs are isolated from line power, earth ground, analog inputs and all outputs.</p>

Specifications	
Current and Auxiliary Outputs	<p>Up to three Milliamp Outputs. These outputs provide a 0 to 21 mA current output into a negative or positive grounded load or into a non-grounded load. Current outputs are isolated from each other, line power, earth ground and all inputs. Outputs can easily be configured via the keyboard to be 0 to 20 mA or 4 to 20 mA without field calibration and for either direct or reverse action when used as a control output.</p> <p>Any current output not being used as a control output can be used in an Auxiliary Output mode. Auxiliary Outputs can be configured to represent any Analog Input, PV, Setpoint, Deviation, or Control Output. The range of an Auxiliary Output can be scaled per the range of the selected variable and can be set anywhere between 0 to 21 mA.</p> <p><i>Resolution:</i> 14 bits over 0 to 21 mA <i>Accuracy:</i> 0.05% of full scale <i>Temperature Stability:</i> 0.01% F.S./°C typical <i>Load Resistance:</i> 0 to 1000 ohms</p> <p>The First Current Output is a standard feature and is present on all instruments. The Second Current Output is an option and is mutually exclusive with Ethernet Communications. The Third Current Output is an option and is mutually exclusive with the other Output 2 Options listed directly below.</p>
Output 2 Options	<p>Output 2 is a socket which may be populated with any one of the following output types:</p> <p>Electromechanical Relay SPDT contacts. Both Normally Open and Normally Closed contacts are brought out to the rear terminals. <i>Resistive Load:</i> 5 amps @ 120 Vac or 240 Vac or 30 Vdc <i>Inductive Load (cos φ = 0.4):</i> 3 amps @ 130 Vac or 250 Vac <i>Inductive Load (L/R = 7 milliseconds):</i> 3.5 amps @ 30 Vdc <i>Motor:</i> 1/6 H.P.</p> <p>Dual Electromechanical Relays Two SPST relays. One Normally Open contact for each relay is brought out to the rear terminals. This option must be used as the Loop 1 output for On-Off Duplex, Time Duplex, Three Position Step Control and Position Proportional Control applications. Instruments with this option can have a total of five relays plus one or two current outputs. <i>Resistive Load:</i> 2 amps @ 120 Vac, 240 Vac or 30 Vdc <i>Inductive Load (cos φ = 0.4):</i> 1 amp @ 130 Vac or 250 Vac <i>Inductive Load (L/R = 7 milliseconds):</i> 1 amp @ 30 Vdc</p> <p>Solid State Relay SPST solid-state contact consisting of a triac N.O. output with zero-crossing detection. <i>Resistive Load:</i> 1.0 amp @ 25°C ambient temperature and 120 or 240 Vac 0.5 amp @ 55°C ambient temperature and 120 or 240 Vac <i>Inductive Load:</i> 50 VA @ 55°C ambient temperature and 120 or 240 Vac <i>Minimum Load:</i> 20 milliamps</p> <p>Open Collector Output Transistor drive for powering an external relay. Isolated from earth ground and all other circuits except the First Current Output. Internally powered @ 30 Vdc. Note: Applying an external power supply to this output will damage the instrument. <i>Maximum Sink Current:</i> 20 mA <i>Overload Protection:</i> 100 mA</p> <p>Third Current Output See above.</p>
Three Relay Board (Optional)	<p>Three SPDT contacts. Both Normally Open and Normally Closed contacts are brought out to the rear terminals for each relay. These relays are used for Alarm outputs or for the output of the second control loop. They may also be used as outputs for Logic Gate functions. <i>Resistive Load:</i> 5 amps @ 120 Vac or 240 Vac or 30 Vdc <i>Inductive Load (cos φ = 0.4):</i> 3 amps @ 130 Vac or 250 Vac <i>Inductive Load (L/R = 7 milliseconds):</i> 3.5 amps @ 30 Vdc <i>Motor:</i> 1/6 H.P.</p>

Specifications	
Alarm Outputs (Optional)	A maximum of four alarm relays are available, depending upon the type and quantity of outputs used for control purposes. Each alarm may have one or two setpoints, each of which can be independently set as high or low alarm. Setpoints can be on any Input, Process Variable, Deviation, Manual Mode, Failsafe, PV Rate, RSP Mode, Communication Shed, or Output. A single adjustable hysteresis of 0.0 to 100.0% is provided. The alarm can also be set as an ON or OFF event at the beginning of a Setpoint Program Ramp or Soak segment. Alarm status is accessible via any communications port and is shown on the display annunciators.
Isolation (Functional)	<p><i>AC Power:</i> Electrically isolated from all other inputs and outputs and earth ground to withstand a HIPOT potential of 1900 Vdc for 2 seconds per Annex K of EN61010-1.</p> <p><i>Analog Inputs and Outputs:</i> Are isolated from each other and all other circuits to withstand a HIPOT potential of 850 Vdc for 2 seconds per Annex K of EN61010-1.</p> <p><i>Digital Inputs and Digital Outputs:</i> Electrically isolated from all other circuits to withstand a HIPOT potential of 850 Vdc for 2 seconds per Annex K of EN61010-1.</p> <p><i>Relay Contacts:</i> With a working voltage of 115/230 Vac, these are electrically isolated from all other circuits to withstand a HIPOT potential of 345 Vdc for 2 seconds per Annex K of EN61010-1</p>
RS422/485 Modbus RTU Communications Interface (Optional)	<p><i>Baud Rate:</i> 4800, 9600, 19,200 or 38,400 baud selectable</p> <p><i>Data Format:</i> Floating point or integer</p> <p><i>Length of Link:</i> 2000 ft (600 m) max. with Belden 9271 Twinax Cable and 120 ohm termination resistors 4000 ft. (1200 m) max. with Belden 8227 Twinax Cable and 100 ohm termination resistors</p> <p><i>Link Characteristics:</i> Two-wire (half-duplex), multi-drop Modbus RTU protocol, 15 drops maximum or up to 31 drops for shorter link length.</p>
Ethernet TCP/IP Communications Interface (Optional)	<p><i>Type:</i> 10Base-T</p> <p><i>Length of Link:</i> 330 ft. (100 m) maximum. Use Shielded twisted-pair, Category 5 (STP CAT5) Ethernet cable.</p> <p><i>Link Characteristics:</i> Four-wire plus shield, single drop, five hops maximum</p> <p><i>IP Address:</i> IP Address is 10.0.0.2 as shipped from the Factory</p> <p><i>Recommended network configuration:</i> Use Switch rather than Hub in order to maximize UDC Ethernet performance.</p> <p><i>Configuration:</i> Ethernet parameters are configured via the Process Instrument Explorer.</p> <p><i>Email:</i> The capability to send two different Emails is provided. These must be configured via the Process Instrument Explorer. It is recommended that the Real Time Clock Option be purchased for any instrument that needs to send Email.</p> <p>Ethernet Communications is mutually exclusive with the Second Current Output.</p>
RS-485 and Ethernet Transaction rates	Host computer must allow a minimum of 20 milliseconds between Read transactions and a minimum of 200 milliseconds between Write transactions.
Infrared Communications (Standard)	<p><i>Type:</i> Serial Infrared (SIR)</p> <p><i>Length of Link:</i> 3 ft. (1 m) maximum for IrDA 1.0 compliant devices</p> <p><i>Baud Rate:</i> 19,200 or 38,400 baud selectable</p>
Power Consumption	<p>24 VA maximum (90 to 264 Vac)</p> <p>18 VA maximum (24 Vac/dc)</p>
Power Inrush Current	<p>10A maximum for 4 ms (under operating conditions), reducing to a maximum of 265 mA (90 to 264 Vac operation) or 900 mA (24 Vac/dc operation) after one second.</p> <p>CAUTION: When applying power to more than one instrument, make sure that sufficient power is supplied. Otherwise, the instruments may not start up normally due to voltage drop from the inrush current.</p>
Weight	3 lbs. (1.3 kg)

Environmental and Operating Conditions				
Parameter	Reference	Rated	Operative Limits	Transportation and Storage
Ambient Temperature	25 ± 3 °C 77 ± 5 °F	15 to 55 °C 58 to 131 °F	0 to 55 °C 32 to 131 °F	-40 to 66 °C -40 to 151 °F
Relative Humidity	10 to 55*	10 to 90*	5 to 90*	5 to 95*
Vibration				
Frequency (Hz)	0	0 to 70	0 to 200	0 to 200
Acceleration (g)	0	0.4	0.6	0.5
Mechanical Shock				
Acceleration (g)	0	1	5	20
Duration (ms))	0	30	30	30
Line Voltage (Vdc)				
24 Vdc	+24 ± 1	22 to 27	20 to 30	--
Line Voltage (Vac)				
90 to 240 Vac	120 ± 1 240 ± 2	90 to 240	90 to 264	-- --
24 Vac	24 ± 1	20 to 27	20 to 27	--
Frequency (Hz)				
(For Vac)	50 ± 0.2 60 ± 0.2	49 to 51 59 to 61	48 to 52 58 to 62	-- --

* The maximum moisture rating only applies up to 40 °C (104 °F). For higher temperatures, the RH specification is derated to maintain constant moisture content.

2.3 Model Number Interpretation

Introduction

Write your controller's model number in the spaces provided below and circle the corresponding items in each table. This information will also be useful when you wire your controller.

Instructions

- Select the desired key number. The arrow to the right marks the selection available.
- Make the desired selections from Tables I through VI using the column below the proper arrow. A dot (•) denotes availability.

Key Number I II III IV V VI

_____ - [] - [] - [] - [] - [] []

KEY NUMBER - UDC3500 Single & Dual Loop Controller

Description
Digital Controller for use with 90 to 264Vac Power + Current Output #1
Digital Controller for use with 24Vac/dc Power + Current Output #1

Selection	Availability
DC3500	↓
DC3501	↓

TABLE I - Specify optional Output and/or Alarms

Output #2	Description
	None
	Current Output (4 to 20mA, 0 to 20 mA) (Current Output #3)
	Electro Mechanical Relay (5 Amp Form C)
	Solid State 1 Amp (Zero-Crossing Type)
	Open Collector transistor output
	Dual 2 Amp Relays (Form A) (Heat/Cool, Pos Prop, TPSC, Relays 1 & 2)
Relay Outputs #3, #4 and #5	Description
	None
	Three (3) E-M Relay (5 Amp Form C)

0	•	•
C	•	•
E	•	•
A	•	•
T	•	•
R	•	•
_0	•	•
_E	•	•

TABLE II - Communications and Software Selections

Communications	Description
	None
	Current Output #2 + (4) Digital Inputs
	Current Output #2 + (4) Digital Inputs + Modbus RS-485
	10 Base-T Ethernet (Modbus RTU) + (4) Digital Inputs
Software Selections	Description
	Standard Functions, Includes Accutune
	Math Option
	Set Point Programming (1 Program, 20 Segments)
	Set Point Programming Plus Math
	HealthWatch
	SPP + HealthWatch
	Math + HealthWatch
	SPP + Math + HealthWatch
Enhanced	Description
	Enhanced SPP (4 Programs, 20 Segments Each)
	Enhanced SPP + Math
	Enhanced SPP + HealthWatch
	Enhanced SPP + Math + HealthWatch
Loops of Control	Description
	Single Loop
	2 Loops + Internal Cascade
Real-Time Clock	Description
	None
	Real-Time Clock (RTC)

0	•	•
1	•	•
2	•	•
3	•	•
_0	•	•
_A	•	•
_B	•	•
_C	•	•
_D	•	•
_E	•	•
_F	•	•
_G	•	•
_H	•	•
_J	•	•
_K	•	•
_L	•	•
_0	•	•
_2	•	•
_0	•	•
_C	•	•

		Availability DC 3500 3501	
		Selection	↓ ↓
TABLE III - Input types can be changed in the field			
Input 1	TC, RTD, mV, 0-5V, 1-5V	1 _ _	• •
	TC, RTD, mV, 0-5V, 1-5V, 0-20mA, 4-20mA	2 _ _	• •
	TC, RTD, mV, 0-5V, 1-5V, 0-20mA, 4-20mA, -1-1V, 0-10V	3 _ _	• •
	Relative Humidity (Requires Input 2)	1 5 _	• •
	Carbon, Oxygen or Dewpoint (Requires Input 2)	1 6 _	• •
Input 2	None	_ 0 _	• •
	TC, RTD, mV, 0-5V, 1-5V, 0-20mA, 4-20mA	_ 1 _	• •
	TC, RTD, mV, 0-5V, 1-5V, 0-20mA, 4-20mA, -1-1V, 0-10V	_ 2 _	• •
	Two HLAI instead of 1 LLAI	_ 3 _	• •
Input 3	None	_ _ 0	• •
	TC, RTD, mV, 0-5V, 1-5V, 0-20mA, 4-20mA	_ _ 1	• •
	TC, RTD, mV, 0-5V, 1-5V, 0-20mA, 4-20mA, -1-1V, 0-10V	_ _ 2	• •
	Two HLAI instead of 1 LLAI	_ _ 3	• •
	Slidewire Input for Position Prop. (Requires Dual Relay Output)	_ _ 4	a a
TABLE IV - Options			
Approvals	CE (Standard)	0 _ _ _	• •
	CE, UL and CSA	1 _ _ _	• •
Tags	None	_ 0 _ _	• •
	Stainless Steel Customer ID Tag - 3 lines w/22 characters/line	T _ _ _	• •
Special Options	None	_ _ 0 _	• •
	Custom Calibration (0.05%) For one Range Type Only (Note 1)	_ _ 1 _	• •
Future Options	None	_ _ _ 0	• •
	None	_ _ _ _	• •
TABLE V - Product Manuals			
Manuals	Product Information on CD - (English)	0 _	• •
	English Manual (Hard Copy)	E _	• •
	French Manual (Hard Copy)	F _	• •
	German Manual (Hard Copy)	G _	• •
	Italian Manual (Hard Copy)	I _	• •
	Spanish Manual (Hard Copy)	S _	• •
Certificate	None	_ 0	• •
	Certificate of Conformance (F3391)	_ C	• •
TABLE VI			
	None	0	• •

Figure 2-1 Model Number Interpretation

2.4 Control and Alarm Relay Contact Information

Control Relays

ATTENTION

Control relays operate in the standard control mode (that is, energized when output state is on).

Table 2-2 Control Relay Contact Information

Unit Power	Control Relay Wiring	Control Relay Contact	Output #1 or #2 Indicator Status
Off	N.O.	Open	Off
	N.C.	Closed	
On	N.O.	Open	Off
		Closed	On
	N.C.	Closed	Off
		Open	On

Alarm Relays

ATTENTION

Alarm relays are designed to operate in a failsafe mode (that is, de-energized during alarm state). This results in alarm actuation when power is OFF or when initially applied, until the unit completes self-diagnostics. If power is lost to the unit, the alarms will de-energize and thus the alarm contacts will close.

Table 2-3 Alarm Relay Contact Information

Unit Power	Alarm Relay Wiring	Variable NOT in Alarm State		Variable in Alarm State	
		Relay Contact	Indicators	Relay Contact	Indicators
Off	N.O.	Open	Off	Open	Off
	N.C.	Closed		Closed	
On	N.O.	Closed	Off	Open	On
	N.C.	Open		Closed	

2.5 Mounting

Physical Considerations

The controller can be mounted on either a vertical or tilted panel using the mounting kit supplied. Adequate access space must be available at the back of the panel for installation and servicing activities.

- Overall dimensions and panel cutout requirements for mounting the controller are shown in Figure 2-2.
- The controller's mounting enclosure must be grounded according to CSA standard C22.2 No. 0.4 or Factory Mutual Class No. 3820 paragraph 6.1.5.
- The front panel is moisture rated NEMA3 and IP55 rated and can be easily upgraded to NEMA4X and IP66. See Figure 2-3 and Table 2-4 Mounting Procedure.

Overall Dimensions

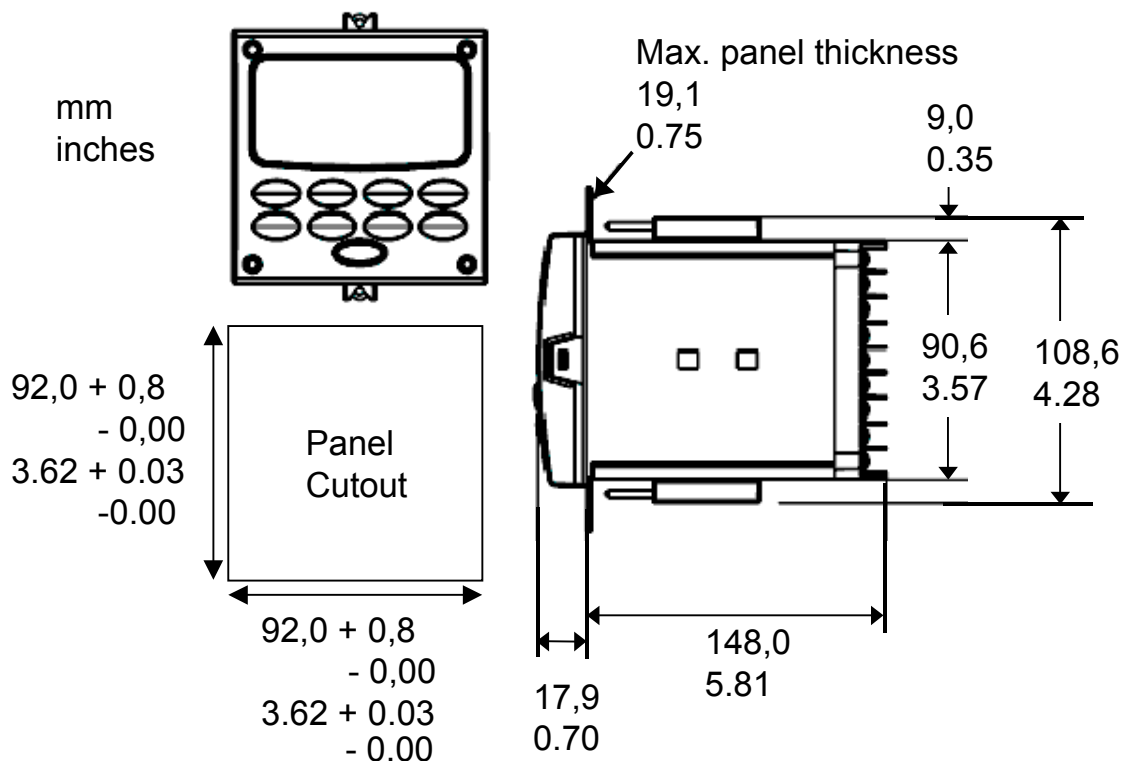

Figure 2-2 Mounting Dimensions (not to scale)

Mounting Notes

Before mounting the controller, refer to the nameplate on the outside of the case and make a note of the model number. It will help later when selecting the proper wiring configuration.

Mounting Method

Before mounting the controller, refer to the nameplate on the outside of the case and make a note of the model number. It will help later when selecting the proper wiring configuration.

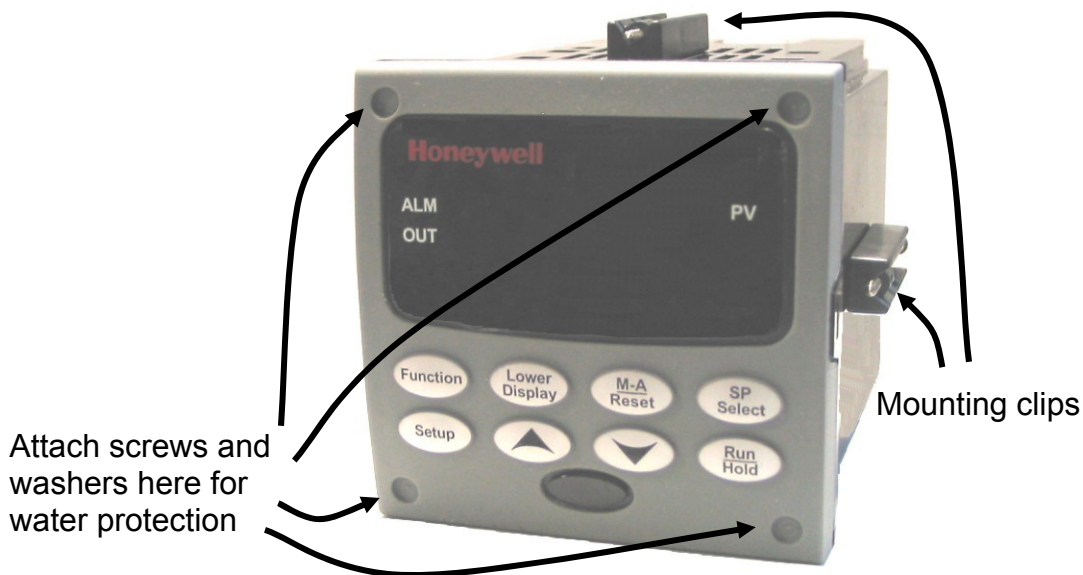

Figure 2-3 Mounting Methods

Mounting Procedure

Table 2-4 Mounting Procedure

Step	Action
1	Mark and cut out the controller hole in the panel according to the dimension information in Figure 2-2.
2	Orient the case properly and slide it through the panel hole from the front.
3	Remove the mounting kit from the shipping container and install the kit as follows: <ul style="list-style-type: none"> For normal installation (NEMA 3/IP55) two mounting clips are required. Insert the prongs of the clips into the two holes in the top and bottom center of the case For water-protected installation (NEMA 4/IP66) four mounting clips are required. There are two options of where to install the mounting clips: <ol style="list-style-type: none"> 1) Insert the prongs of the clips into the two holes on the left and right side of the top and bottom of the case or 2) on the center on each of the four sides. Tighten screws to 2 lb-inch (22 N•cm) to secure the case against the panel. CAUTION: Over tightening will cause distortion and the unit may not seal properly.
4	For water-protected installation (NEMA 4/IP66), install four screws with washers into the four recessed areas in the corners of the front bezel (Figure 2-3). Push the point of the screw through the center piercing the elastomeric material and then tighten screws to 5 lb-in (56 N•cm).

2.6 Wiring

2.6.1 Electrical Considerations

Line voltage wiring

This controller is considered “rack and panel mounted equipment” per EN61010-1, Safety Requirements for Electrical Equipment for Measurement, Control, and Laboratory Use, Part 1: General Requirements. Conformity with 72/23/EEC, the Low Voltage Directive requires the user to provide adequate protection against a shock hazard. The user shall install this controller in an enclosure that limits OPERATOR access to the rear terminals.

Mains Power Supply

This equipment is suitable for connection to 90 to 264 Vac or to 24 Vac/dc 50/60 Hz, power supply mains. It is the user’s responsibility to provide a switch and non-time delay (North America), quick-acting, high breaking capacity, Type F (Europe), 1/2A, 250V fuse(s), or circuit breaker for 90-264 Vac applications; or 2 A, 125 V fuse or circuit breaker for 24 Vac/dc applications, as part of the installation. The switch or circuit breaker shall be located in close proximity to the controller, *within easy reach of the OPERATOR*. The switch or circuit breaker shall be marked as the disconnecting device for the controller.



Applying 90-264 Vac to an instrument rated for 24 Vac/dc will severely damage the instrument and is a fire and smoke hazard.

When applying power to multiple instruments, make certain that sufficient current is supplied. Otherwise, the instruments may not start up normally due to the voltage drop caused by the in-rush current.

Controller Grounding

PROTECTIVE BONDING (grounding) of this controller and the enclosure in which it is installed shall be in accordance with National and Local electrical codes. To minimize electrical noise and transients that may adversely affect the system, supplementary bonding of the controller enclosure to a local ground, using a No. 12 (4 mm²) copper conductor, is recommended.

Control/Alarm Circuit Wiring

The insulation of wires connected to the Control/Alarm terminals shall be rated for the highest voltage involved. Extra Low Voltage (ELV) wiring (input, current output, and low voltage Control/Alarm circuits) shall be separated from HAZARDOUS LIVE (>30 Vac, 42.4 Vpeak, or 60 Vdc) wiring per Permissible Wiring Bundling, Table 2-5.

Electrical Noise Precautions

Electrical noise is composed of unabated electrical signals, which produce undesirable effects in measurements and control circuits.

Digital equipment is especially sensitive to the effects of electrical noise. Your controller has built-in circuits to reduce the effect of electrical noise from various sources. If there is a need to further reduce these effects:

- *Separate External Wiring*—Separate connecting wires into bundles (See Permissible Wiring Bundling - Table 2-5) and route the individual bundles through separate conduit metal trays.
- *Use Suppression Devices*—For additional noise protection, you may want to add suppression devices at the external source. Appropriate suppression devices are commercially available.

ATTENTION

For additional noise information, refer to document number 51-52-05-01, *How to Apply Digital Instrumentation in Severe Electrical Noise Environments*.

Permissible Wiring Bundling

Table 2-5 Permissible Wiring Bundling

Bundle No.	Wire Functions
1	<ul style="list-style-type: none"> • Line power wiring • Earth ground wiring • Line voltage control relay output wiring • Line voltage alarm wiring
2	<p>Analog signal wire, such as:</p> <ul style="list-style-type: none"> • Input signal wire (thermocouple, 4 to 20 mA, etc.) • 4-20 mA output signal wiring <p>Digital input signals</p>
3	<ul style="list-style-type: none"> • Low voltage alarm relay output wiring • Low voltage wiring to solid state type control circuits • Low voltage wiring to open collector type control circuits

2.7 Wiring Diagrams

Identify Your Wiring Requirements

To determine the appropriate diagrams for wiring your controller, refer to the model number interpretation in this section. The model number of the controller is on the outside of the case.

Output Functionality and Restrictions

Table 2-6 and Table 2-7 show the control functionality and number of alarms that are available based upon the installed outputs quantity and type. First, use the left-most column to find the Control Output Algorithm desired for your instrument. Then use the second column to find the Output 2 Option selection installed in your instrument. The rest of the columns will then show how the instrument delivers your desired Output functionality and the quantity of alarms available.

In Table 2-6, “HEAT” is used as meaning Loop 1 Control Output #1 and “COOL” is used as meaning Loop 1 Control Output #2. When Position Proportional or Three Position Step Control (TPSC) is configured, then “HEAT” means OPEN while “COOL” means CLOSE.

In Table 2-7, “Loop 2 HEAT” is used as meaning Loop 2 Control Output #1 and “Loop 2 COOL” is used as meaning Loop 2 Control Output #2.

See Figure 2-4 Composite Wiring Diagram, for information on where the customer terminals are for all of these outputs and alarms.

ATTENTION

The selection for Loop 1 Output takes precedence over the selection for Loop 2 Output. For example, if you select the Loop 1 Output Algorithm as Current Duplex 50%, then you cannot have Current Duplex 50% as the Output Algorithm for Loop 2.

The Output 2 option shown in these tables as “Single Relay” can be any of the following selections: Electro-Mechanical Relay, Solid-State Relay or Open Collector Output.

If the controller is configured to use the same relay for more than one function, then the following priority is used to determine how the relay functions: Control Outputs take precedence over Alarms, which in turn take precedence over Time/Events, which in turn take precedence over Logic Gate Outputs.

For example, if you select the Loop 2 Output Algorithm as Time Simplex (which uses Relay 3), enable Alarm 3 (which also uses Relay 3) and configure a Logic Gate to use Relay 3, then the instrument will use Relay #3 to perform the Time Simplex output and ignore the Alarm and Logic Gate functions.

Table 2-6 Single or Cascade Loop Controller – Loop 1 Output Functionality and Restrictions

Output Alg. Selection	Output #2 Option	Function of Output #2	1st Current Output	2nd Current Output *	Relay #3	Relay #4	Relay #5
Time Simplex or ON-OFF Simplex	Single Relay	HEAT	NUL1	NUL1	Alarm 3	Alarm 2	Alarm 1
	Third Current Output	N/A	N/A	N/A	N/A	N/A	N/A
	Dual Relay	HEAT	NUL1	NUL1	Alarm 3	Alarm 2	Alarm 1
	None	N/A	N/A	N/A	N/A	N/A	N/A
Time Duplex or ON-OFF Duplex or TPSC or Position Proportional **	Single Relay	N/A	N/A	N/A	N/A	N/A	N/A
	Third Current Output	N/A	N/A	N/A	N/A	N/A	N/A
	Dual Relay	HEAT and COOL	NUL1	NUL1	Alarm 3	Alarm 2	Alarm 1
	None	N/A	N/A	N/A	N/A	N/A	N/A
Current Simplex	Single Relay	Alarm 4	HEAT	NUL1	Alarm 3	Alarm 2	Alarm 1
	Third Current Output	NUL1	HEAT	NUL1	Alarm 3	Alarm 2	Alarm 1
	Dual Relay	Alarm 4	HEAT	NUL1	Alarm 3	Alarm 2	Alarm 1
	None	N/A	HEAT	NUL1	Alarm 3	Alarm 2	Alarm 1
Current Duplex 100 % 1st Current Output = COOL and HEAT	Single Relay	Alarm 4	HEAT and COOL	NUL1	Alarm 3	Alarm 2	Alarm 1
	Third Current Output	NUL1	HEAT and COOL	NUL1	Alarm 3	Alarm 2	Alarm 1
	Dual Relay	Alarm 4	HEAT and COOL	NUL1	Alarm 3	Alarm 2	Alarm 1
	None	N/A	HEAT and COOL	NUL1	Alarm 3	Alarm 2	Alarm 1
Current Duplex 50 % *** Cur #1 = HEAT Cur #2 or #3 = COOL	Single Relay	Alarm 4	HEAT	COOL	Alarm 3	Alarm 2	Alarm 1
	Third Current Output	NUL1 ***	HEAT	COOL ***	Alarm 3	Alarm 2	Alarm 1
	Dual Relay	Alarm 4	HEAT	COOL	Alarm 3	Alarm 2	Alarm 1
	None	N/A	HEAT	COOL	Alarm 3	Alarm 2	Alarm 1
Current/Time First Current Out = COOL Time = HEAT	Single Relay	HEAT	COOL	NUL1	Alarm 3	Alarm 2	Alarm 1
	Third Current Output	N/A	N/A	N/A	N/A	N/A	N/A
	Dual Relay	HEAT	COOL	NUL1	Alarm 3	Alarm 2	Alarm 1
	None	N/A	N/A	N/A	N/A	N/A	N/A
Time/Current Time = COOL First Current Out = HEAT	Single Relay	COOL	HEAT	NUL1	Alarm 3	Alarm 2	Alarm 1
	Third Current Output	N/A	N/A	N/A	N/A	N/A	N/A
	Dual Relay	COOL	HEAT	NUL1	Alarm 3	Alarm 2	Alarm 1
	None	N/A	N/A	N/A	N/A	N/A	N/A

TPSC = Three Position Step Control

N/A = The output form or the individual output is **Not Available**, not operable or is not used for this Output #2 Option selection.

NUL1 = **Not Used on Loop 1** – This particular output is not used for the selected Loop 1 Output Type, But it may be used for the Second Loop Output Type. Refer to the selection made in Table 2-7. Any current output not used as a Control Output for either loop may be used as an Auxiliary Output.

Table 2-7 Dual Loop Controller – Loop 2 Output Functionality and Restrictions

Loop 2 Output Algorithm Selection	Output #2 Option	Function of Output #2	1st Current Output	2nd Current Output *	Relay #3	Relay #4	Relay #5
Time Simplex or ON-OFF Simplex	Third Current Output	NUL2	NUL2	NUL2	Loop 2 HEAT	Alarm 2	Alarm 1
	All Other Options	NUL2	NUL2	NUL2	Loop 2 HEAT	Alarm 2	Alarm 1
Time Duplex or ON-OFF Duplex	Third Current Output	NUL2	NUL2	NUL2	Loop 2 HEAT	Loop 2 COOL	Alarm 1
	All Other Options	NUL2	NUL2	NUL2	Loop 2 HEAT	Loop 2 COOL	Alarm 1
Current Simplex	Third Current Output	Loop 2 HEAT	NUL2	NUL2	Alarm 3	Alarm 2	Alarm 1
	All Other Options	NUL2	NUL2	Loop 2 HEAT	Alarm 3	Alarm 2	Alarm 1
Current Duplex 100 % Second or Third Current Out = COOL and HEAT	Third Current Output	Loop 2 HEAT and COOL	NUL2	NUL2	Alarm 3	Alarm 2	Alarm 1
	All Other Options	NUL2	NUL2	Loop 2 HEAT and COOL	Alarm 3	Alarm 2	Alarm 1
Current Duplex 50 % *** Second Current = HEAT Third Current = COOL	Third Current Output	Loop 2 HEAT	NUL2	Loop 2 COOL	Alarm 3	Alarm 2	Alarm 1
	All Other Options	N/A2	N/A2	N/A2	N/A2	N/A2	N/A2
Current/Time Second or Third Current = COOL Time = HEAT	Third Current Output	Loop 2 COOL	NUL2	NUL2	Loop 2 HEAT	Alarm 2	Alarm 1
	All Other Options	NUL2	NUL2	Loop 2 COOL	Loop 2 HEAT	Alarm 2	Alarm 1
Time/Current Time = COOL Second or Third Current = HEAT	Third Current Output	Loop 2 HEAT	NUL2	NUL2	Loop 2 COOL	Alarm 2	Alarm 1
	All Other Options	NUL2	NUL2	Loop 2 HEAT	Loop 2 COOL	Alarm 2	Alarm 1

NUL2 = **Not Used** on **Loop 2** – This particular output is not used for the selected Second Loop Output type, but it may be used for the First Loop Output type. Refer to the selection made in Table 2-6. Any Current Output not used as a Control Output on either loop may be configured as an Auxiliary Output.

N/A2 = Current Duplex 50% is **Not Available** on **Loop 2** unless the Third Current Output is installed.

* The Second Current Output and Ethernet Communications are mutually exclusive.

** TPSC and Position Proportional are available only on Loop 1.

*** Current Duplex 50% is available only on Loop 1 or Loop 2, it cannot be used on both loops. If the Second Current Output is not present, then the Third Current Output is used as Loop 1 COOL output.

Wiring the Controller

Using the information contained in the model number, select the appropriate wiring diagrams from the composite wiring diagram below. Refer to the individual diagrams listed to wire the controller according to your requirements.

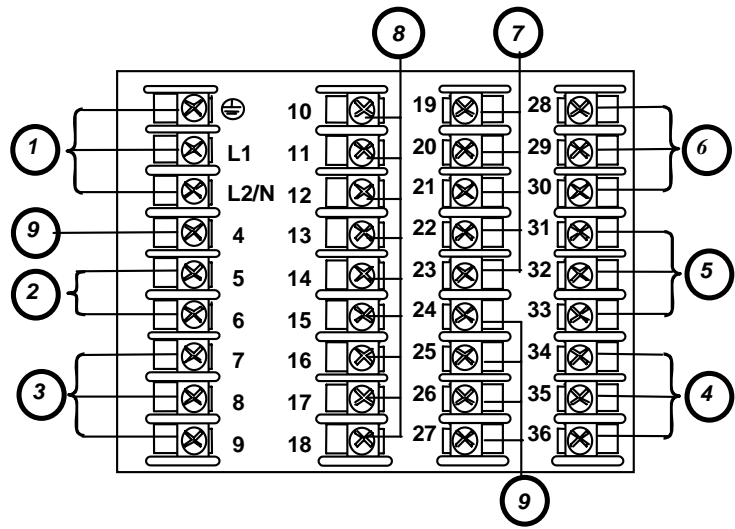

See table for callout details

Figure 2-4 Composite Wiring Diagram

Callout	Details
1	AC/DC Line Voltage Terminals. See Figure 2-5.
2	First Current Output Terminals. See Figure 2-12.
3	Output 2 Option Terminals. See Figure 2-14 through Figure 2-19.
4	Input #1 Terminals. See Figure 2-6.
5	Input #2 Terminals. See Figure 2-7. Dual HLAI Inputs #2 and #4 Terminals. See Figure 2-9 and Figure 2-11.
6	Input #3 Terminals. See Figure 2-8. Dual HLAI Inputs #3 and #5 Terminals. See Figure 2-10 and Figure 2-11.
7	Digital Inputs Terminals. See Figure 2-23.
8	Optional Relays Terminals (Relays 3, 4 and 5). See Figure 2-24.
9	Optional Interface Second Current Output Terminals. See Figure 2-13. RS-485 Communications Terminals. See Figure 2-20. Ethernet Communications Terminals. See Figure 2-22.

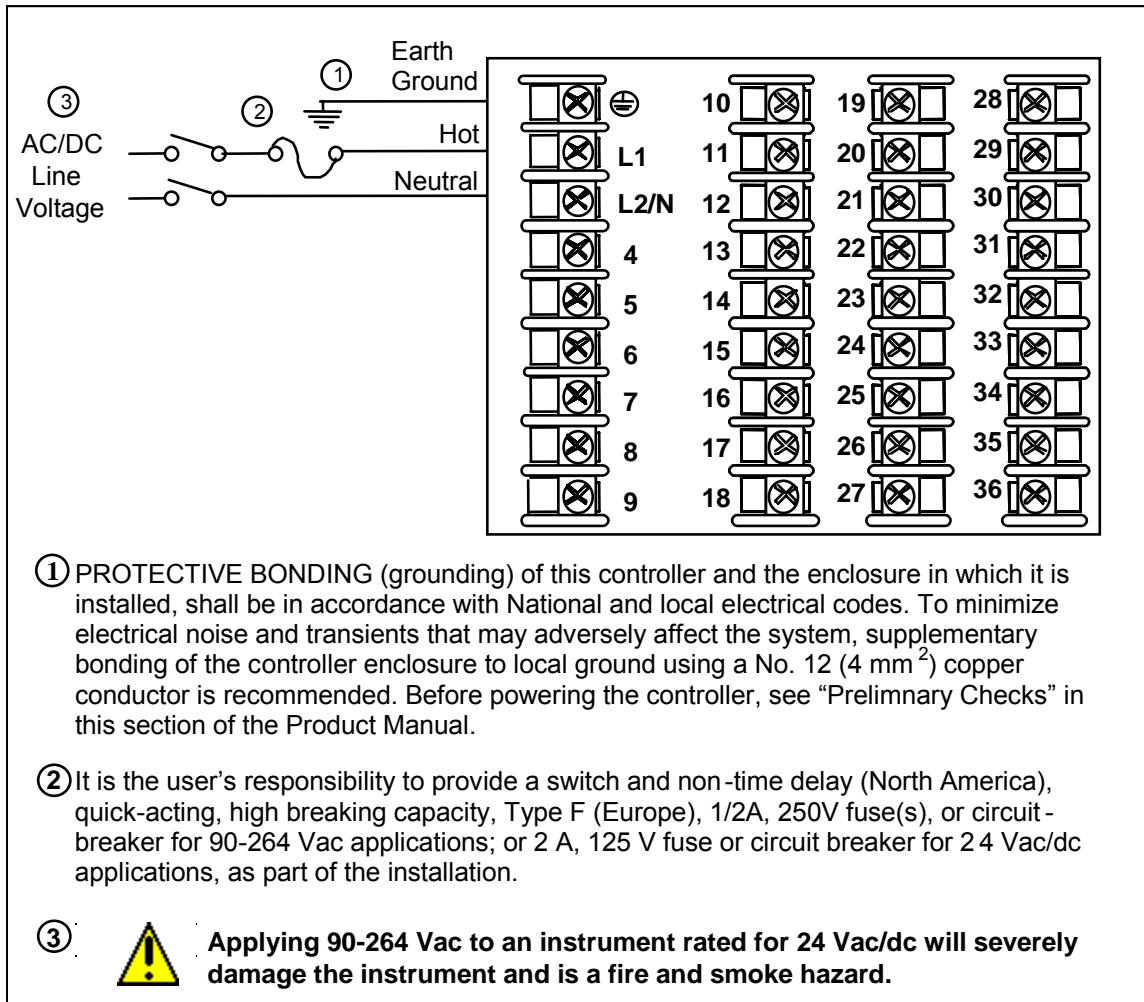

Figure 2-5 Mains Power Supply

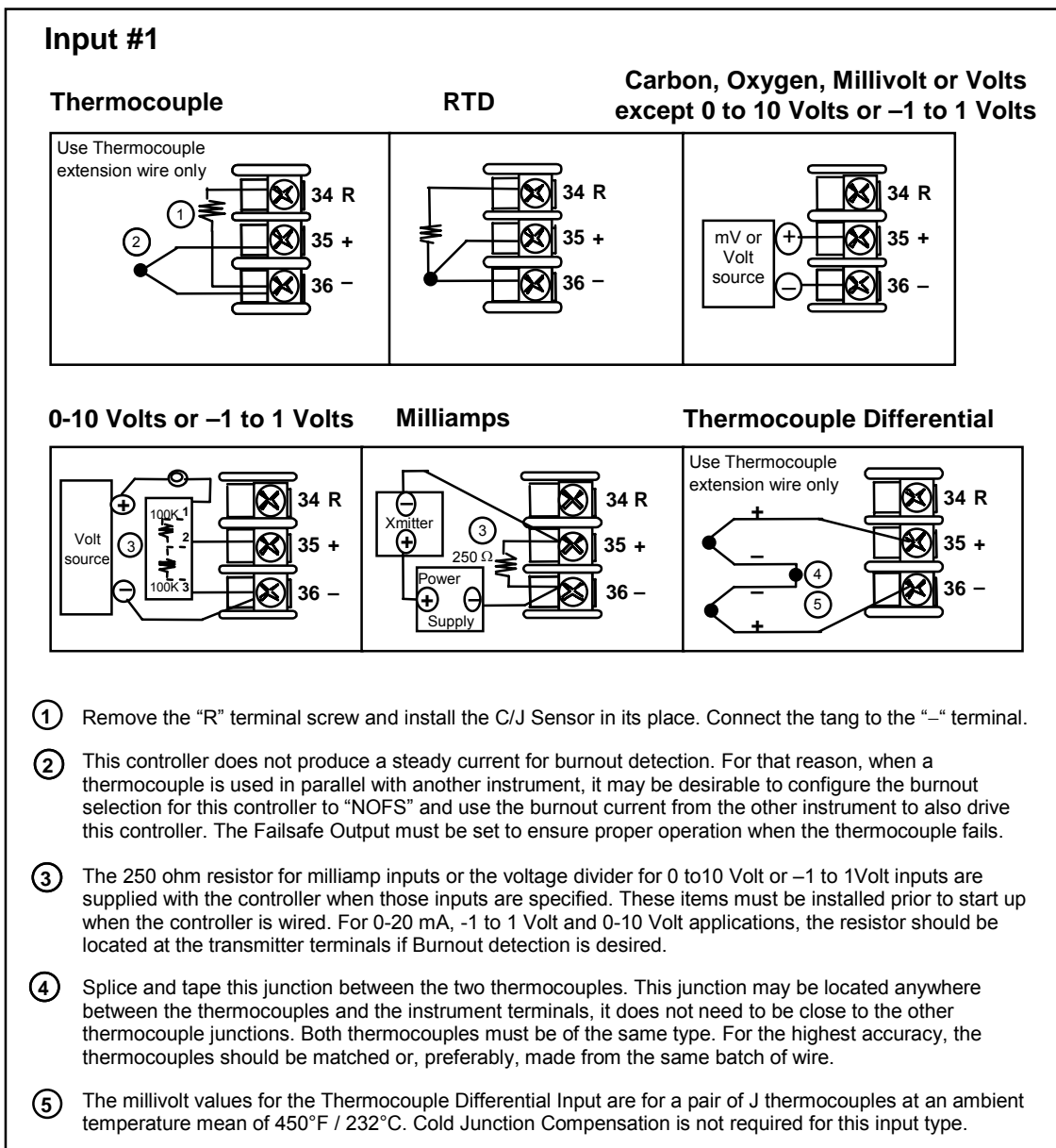

Figure 2-6 Input 1 Connections

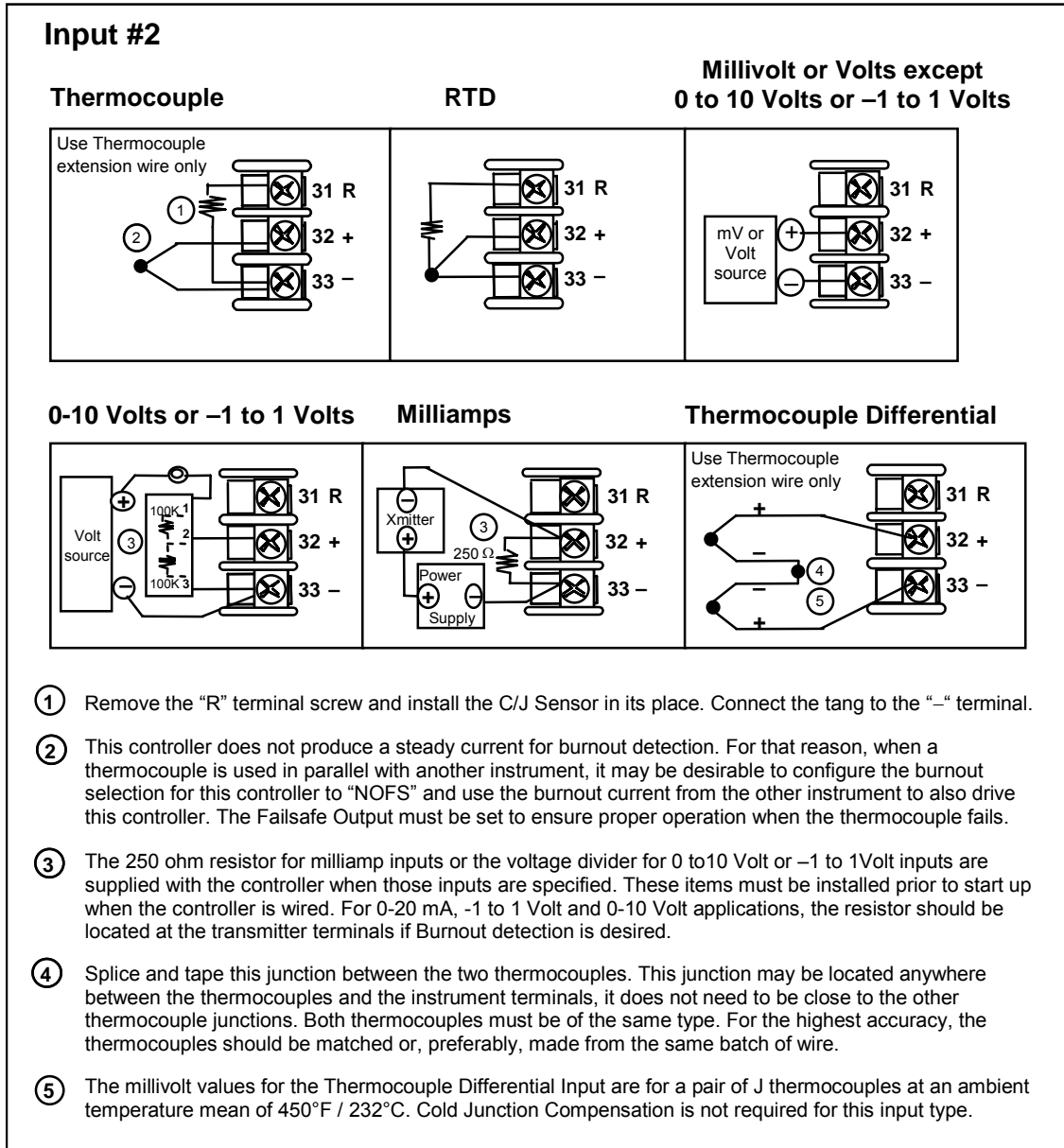
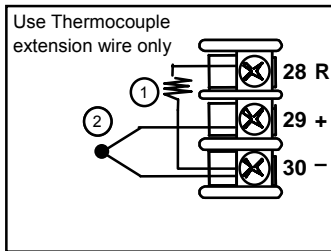

Figure 2-7 Input 2 Connections

Input #3

Thermocouple



RTD

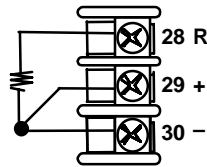

Millivolt or Volts except 0 to 10 Volts or -1 to 1 Volts

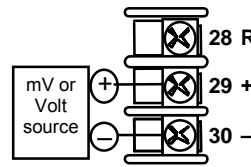

0-10 Volts or -1 to 1 Volts

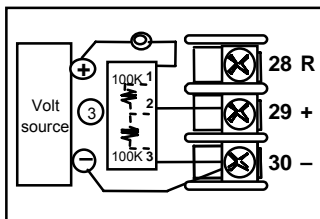

Milliamps

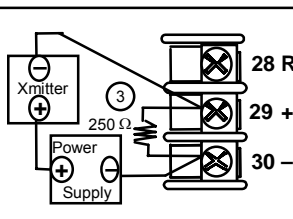

Thermocouple Differential

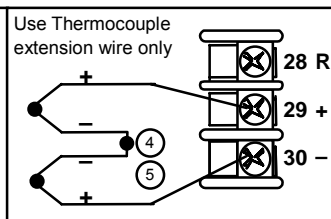

Slidewire Input (for Position Proportional Control or Three Position Step Control)

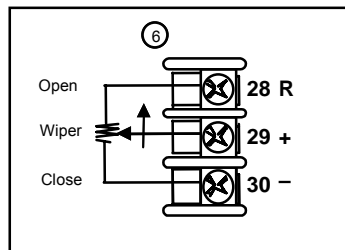

- ① Remove the “R” terminal screw and install the C/J Sensor in its place. Connect the tang to the “-” terminal.
- ② This controller does not produce a steady current for burnout detection. For that reason, when a thermocouple is used in parallel with another instrument, it may be desirable to configure the burnout selection for this controller to “NOFS” and use the burnout current from the other instrument to also drive this controller. The Failsafe Output must be set to ensure proper operation when the thermocouple fails.
- ③ The 250 ohm resistor for milliamp inputs or the voltage divider for 0 to10 Volt or -1 to 1Volt inputs are supplied with the controller when those inputs are specified. These items must be installed prior to start up when the controller is wired. For 0-20 mA, -1 to 1 Volt and 0-10 Volt applications, the resistor should be located at the transmitter terminals if Burnout detection is desired.
- ④ Splice and tape this junction between the two thermocouples. This junction may be located anywhere between the thermocouples and the instrument terminals, it does not need to be close to the other thermocouple junctions. Both thermocouples must be of the same type. For the highest accuracy, the thermocouples should be matched or, preferably, made from the same batch of wire.
- ⑤ The millivolt values for the Thermocouple Differential Input are for a pair of J thermocouples at an ambient temperature mean of 450°F / 232°C. Cold Junction Compensation is not required for this input type.
- ⑥ Input 3 is used to measure the Slidewire Input for Position Proportional Control.

Figure 2-8 Input 3 Connections

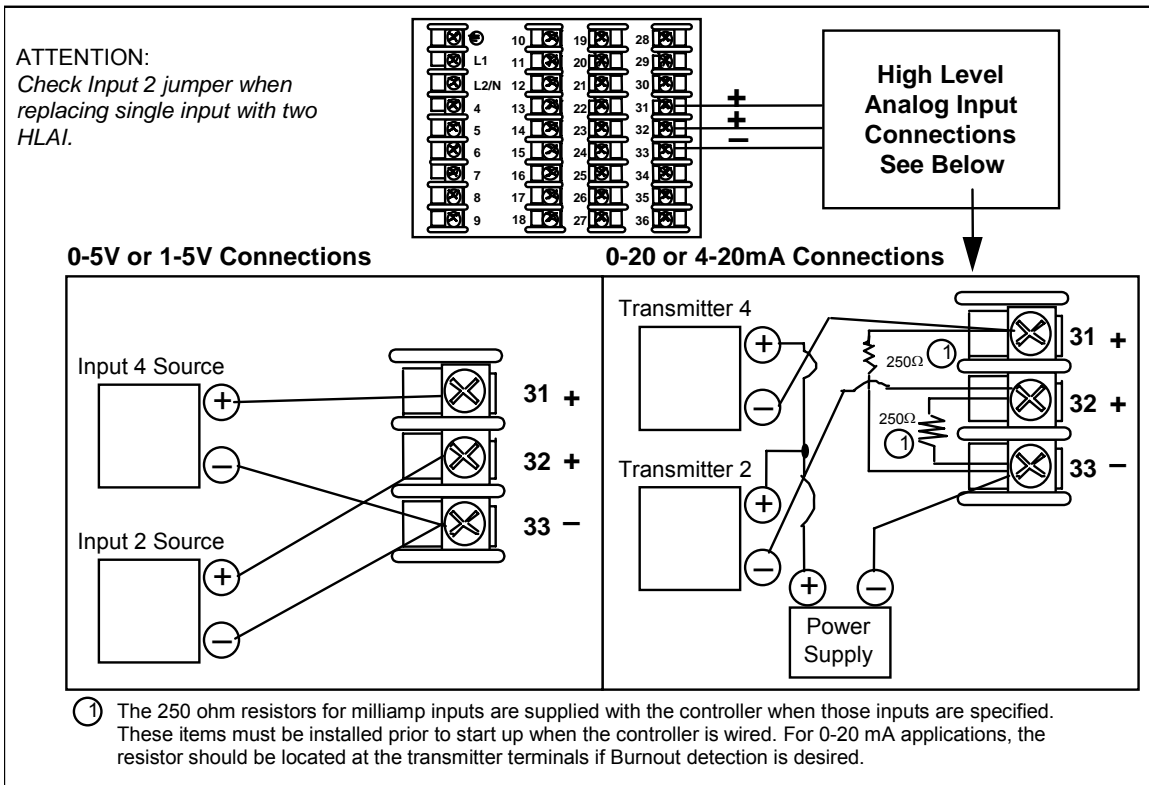

Figure 2-9 HLAI Inputs 2 and 4 Connections

See Figure 2-11 for Jumper Positions.

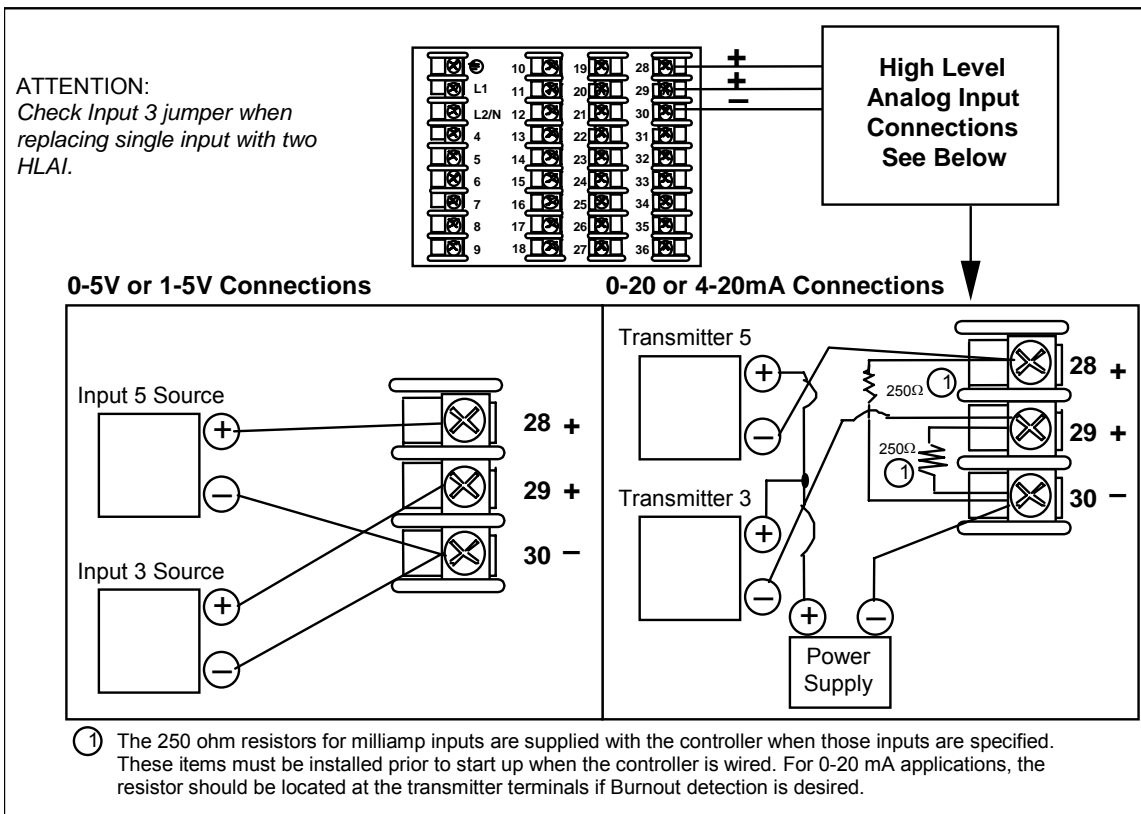

Figure 2-10 HLAI Inputs 3 and 5 Connections

See Figure 2-11 for Jumper Positions.

Jumper Location		
Jumper Position	W1 Single Input	W2 Two HLAI
Input Types Available	Thermocouple, RTD, Volt, Millivolt, Milliamp, Radiomatic and (Input 3 only) Slidewire	2 nd Input becomes HLAI Inputs 2 & 4 3 rd Input becomes HLAI Inputs 3 & 5

Figure 2-11 Optional Analog Input Jumper Positions

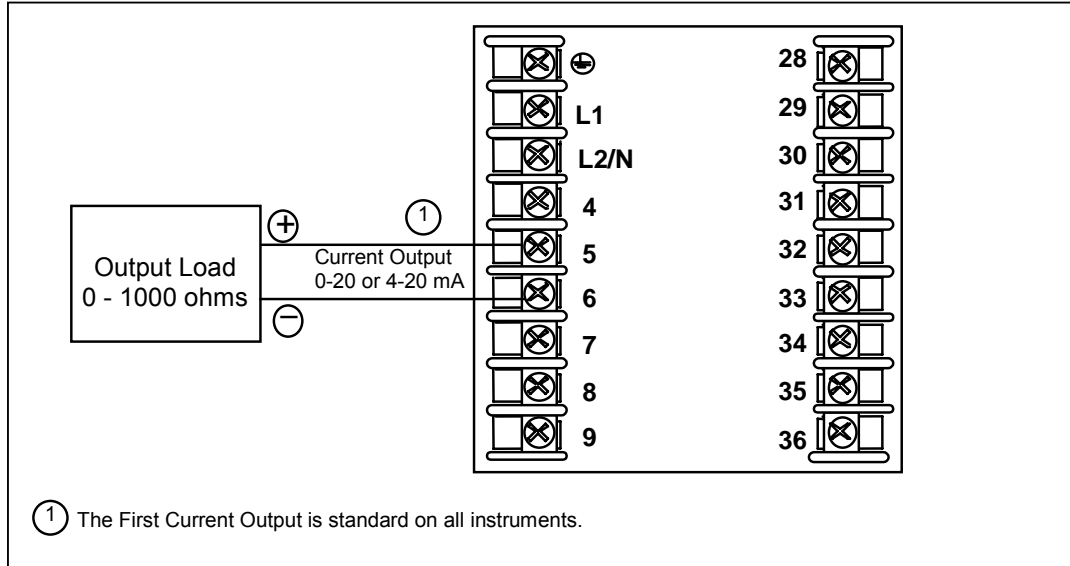

Figure 2-12 First Current Output

See Table 2-6 and Table 2-7 for other information about output types.

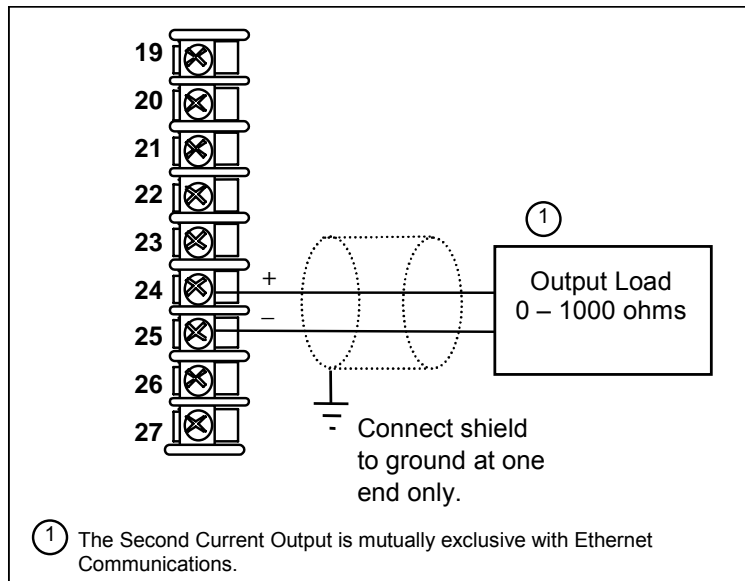

Figure 2-13 Second Current Output

See Table 2-6 and Table 2-7 for other information about output types.

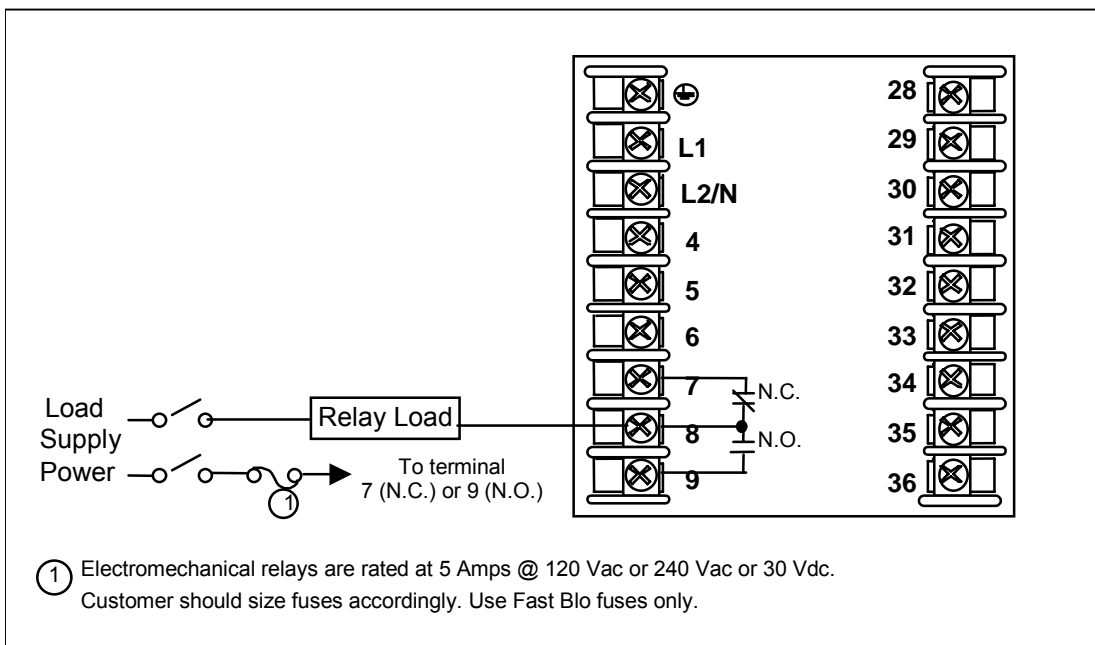

Figure 2-14 Output #2 – Electromechanical Relay Output

See Table 2-6 and Table 2-7 for other information about output types.

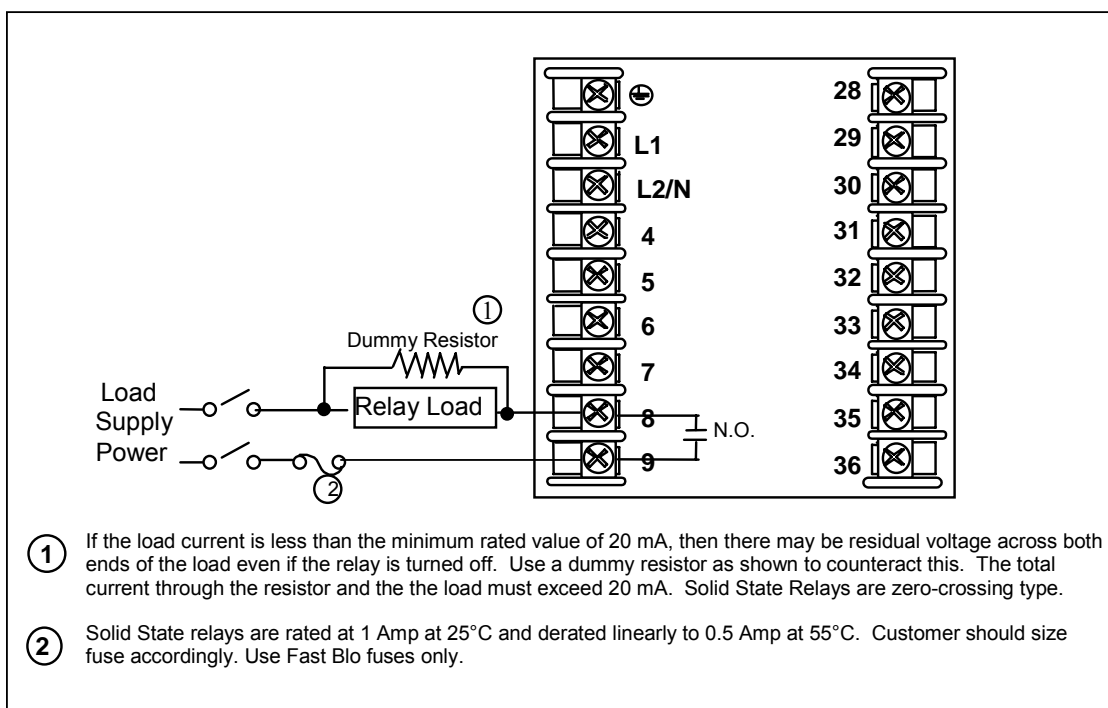

Figure 2-15 Output #2 – Solid State Relay Output

See Table 2-6 and Table 2-7 for other information about output types.

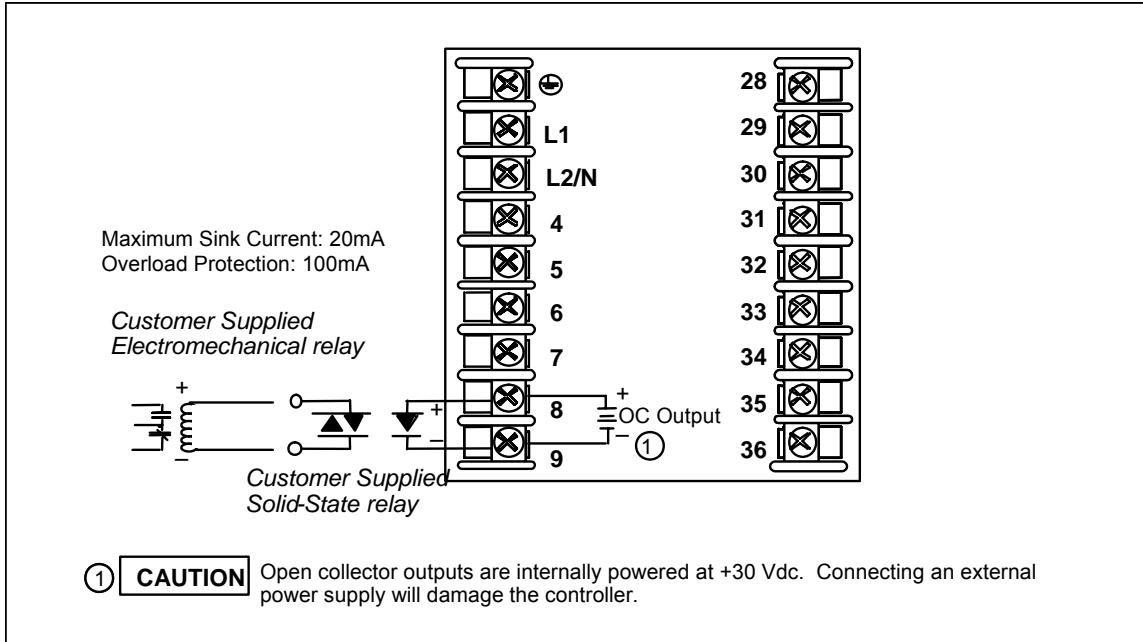

Figure 2-16 Output #2 – Open Collector Output- Third

See Table 2-6 and Table 2-7 for other information about output types.

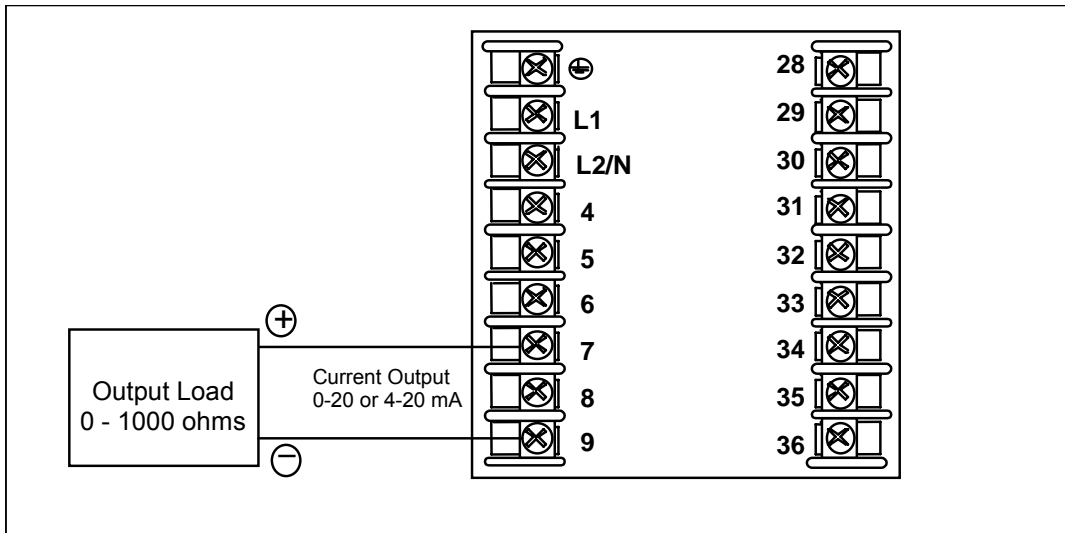

Figure 2-17 Output #2 – Third Current Output

See Table 2-6 and Table 2-7 for other information about output types.

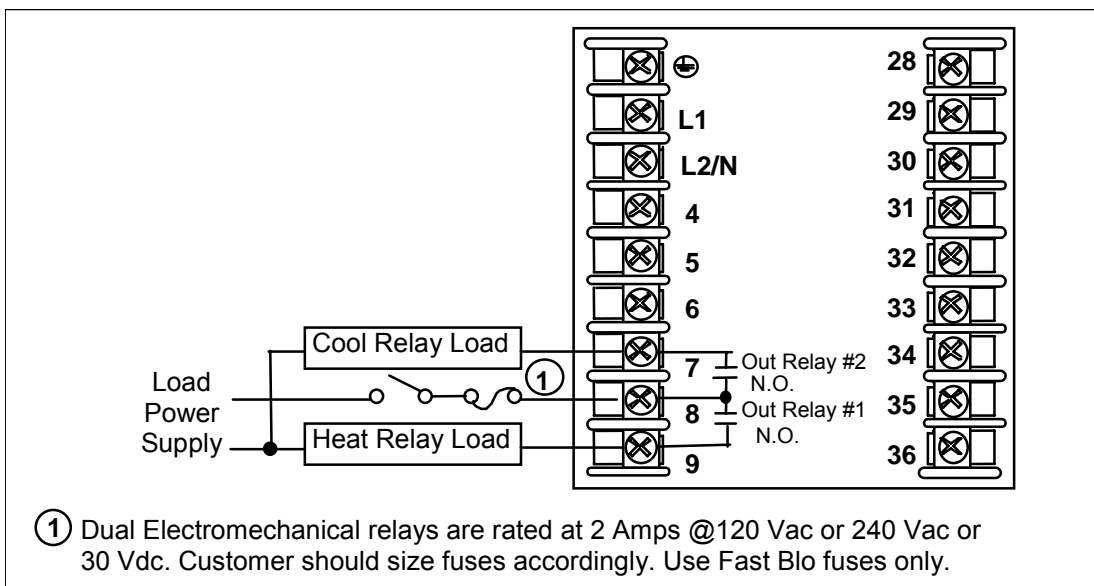

Figure 2-18 Output #2 – Dual Relay Output for Time Duplex

See Table 2-6 and Table 2-7 for other information about output types.

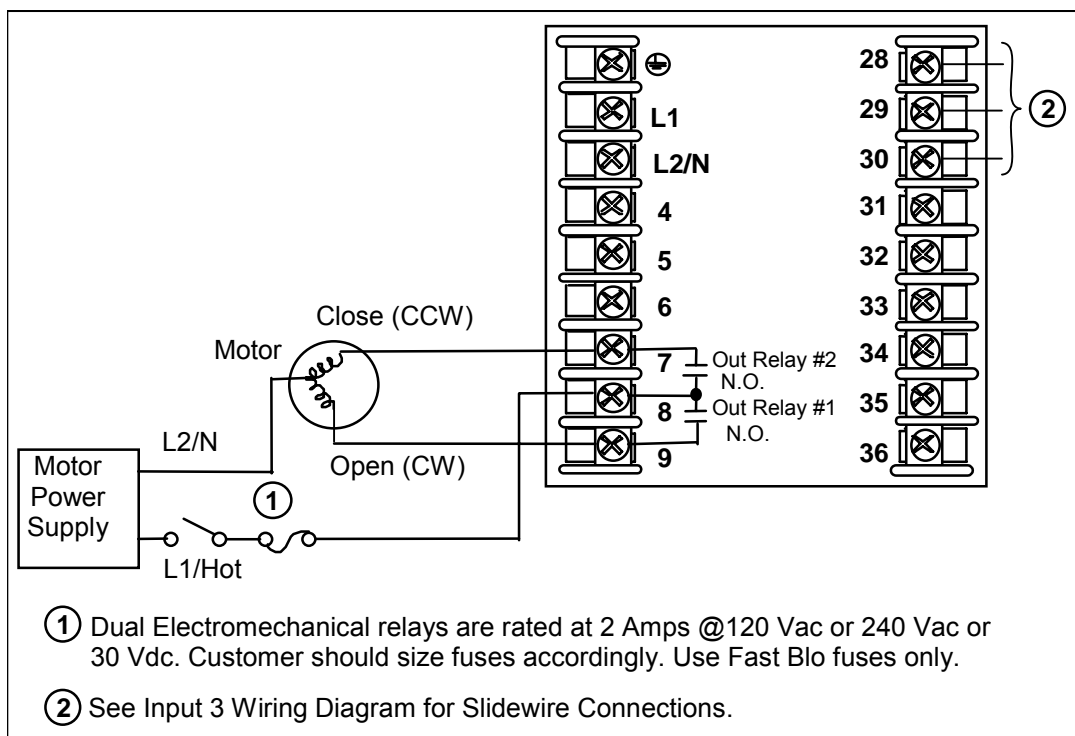

Figure 2-19 Output #2 – Dual Relay Output for Position Proportional or Three Position Step Control

See Table 2-6 and Table 2-7 for other information about output types. See Figure 2-8 for Slidewire connections.

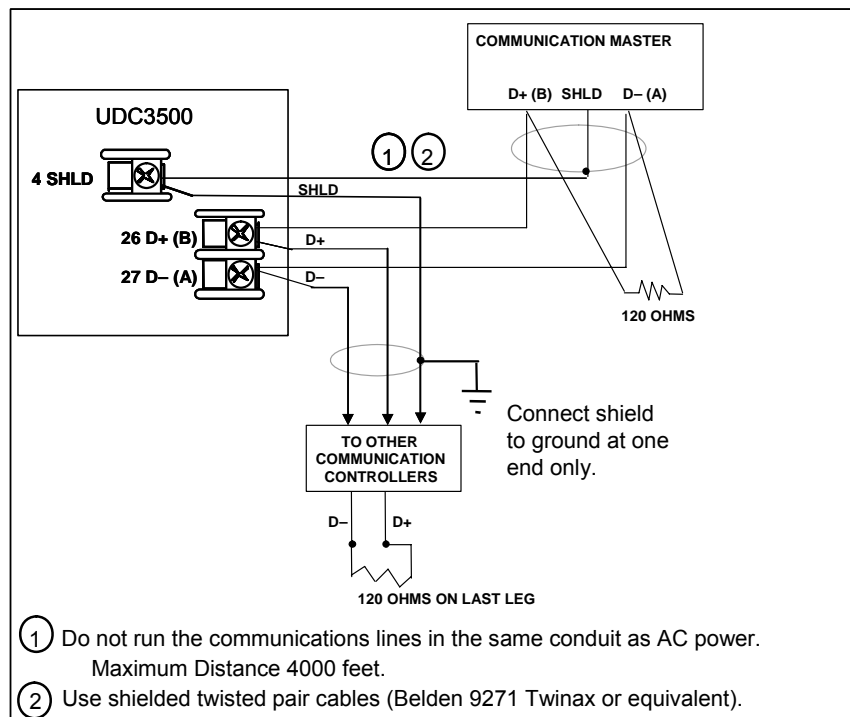

Figure 2-20 RS-422/485 Communications Option Connections

RS-422/485 connections must be “daisy-chained,” T-drop connections are not allowed.

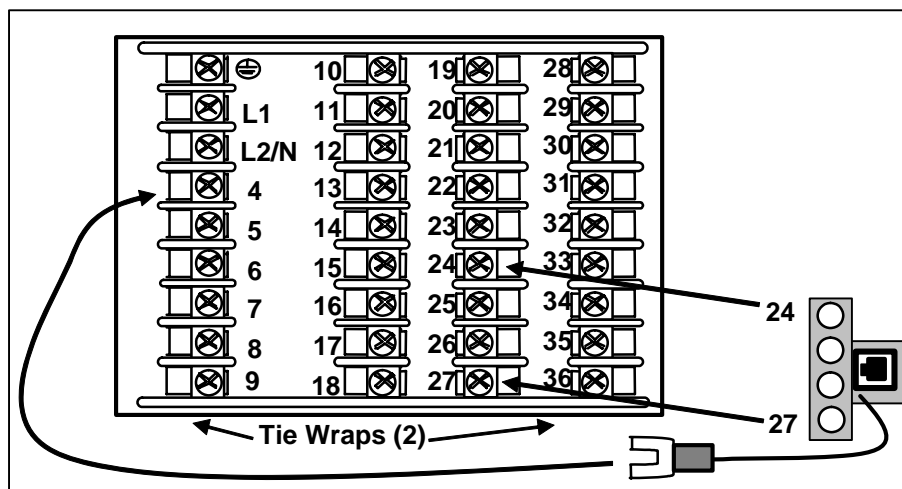

Figure 2-21 Ethernet Communications Option with Adaptor Board

Instruments equipped with the Ethernet Communications Option come with an Ethernet Adaptor Kit. To use this kit, first remove the four screws on your instrument from Terminal Block positions 24 through 27. Place the Ethernet Adaptor Board on to the terminal block as shown and then secure it in place with the four long screws provided in the kit. Route the long wire on the Ethernet Adaptor Board over to Terminal #4 on your instrument. The RJ-45 connector on the Ethernet Adaptor Board will allow you to use a

straight-through cable to connect the controller to a MDI Compliant Hub or Switch. Alternatively, you may use a **crossover cable** to connect your controller directly to a PC, which is useful for commissioning purposes. Use only Category 5 (STP CAT5) shielded twisted-pair Ethernet cables. For strain relief, secure your Ethernet cable to the controller with the tie wraps included in the kit using the holes in the bottom controller flange.

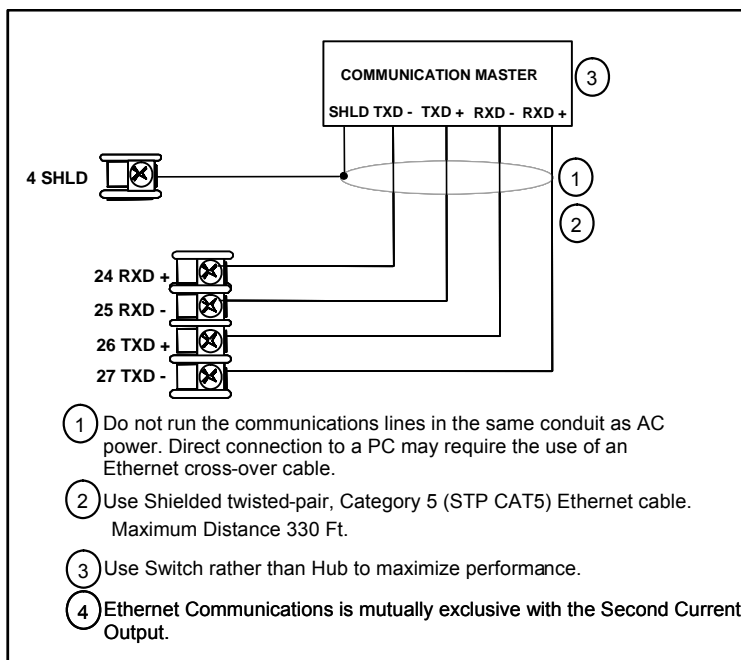

Figure 2-22 Ethernet Communications Option without Adaptor Board

If you would rather wire your UDC to your Ethernet connection without using the Ethernet Adaptor Board, then Figure 2-22 and Table 2-8 show the connections for a UDC to a MDI Compliant Hub or Switch utilizing a straight-through cable or for connecting a UDC to a PC utilizing a crossover cable.

Table 2-9 shows the connections for a UDC to a PC utilizing a straight-through cable (wiring the UDC cable this way makes the necessary cross-over connections).

Table 2-8 Terminals for connecting a UDC to a MDI Compliant Hub or Switch utilizing a cross-over cable

UDC Terminal	UDC Signal Name	RJ45 Socket Pin #	Switch Signal Name
Position 4	Shield	Shield	Shield
Position 24	RXD-	6	TXD-
Position 25	RXD+	3	TXD+
Position 26	TXD-	2	RXD-
Position 27	TXD+	1	RXD+

Table 2-9 Terminals for connecting a UDC directly to a PC utilizing a straight-through cable

UDC Terminal	UDC Signal Name	RJ45 Socket Pin #	PC Signal Name
Position 4	Shield	Shield	Shield
Position 24	RXD-	2	TXD-
Position 25	RXD+	1	TXD+
Position 26	TXD-	6	RXD-
Position 27	TXD+	3	RXD+

Use only Category 5 (STP CAT5) shielded twisted-pair Ethernet cables.

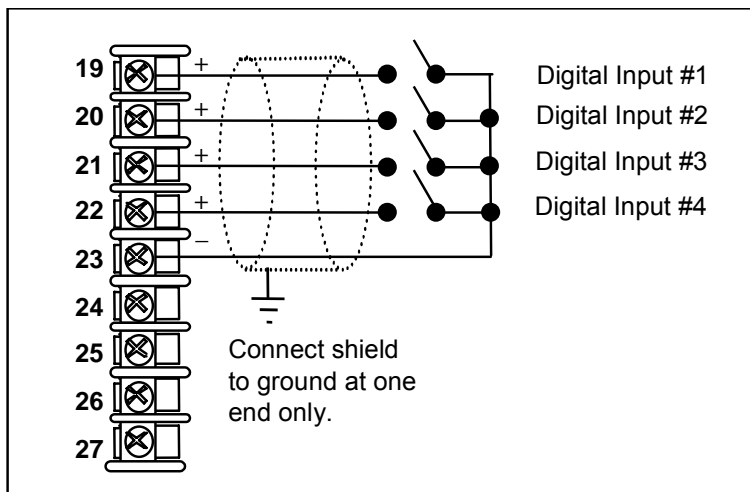

Figure 2-23 Digital Inputs

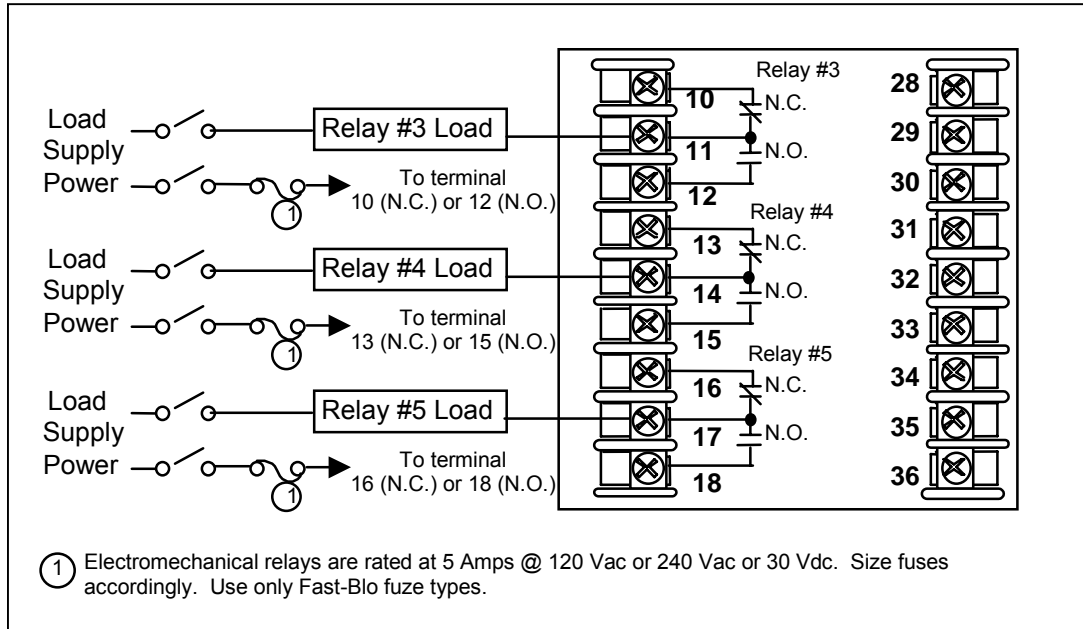

Figure 2-24 Optional Electromechanical Relay Outputs

See Table 2-6 and Table 2-7 for other information about output types.

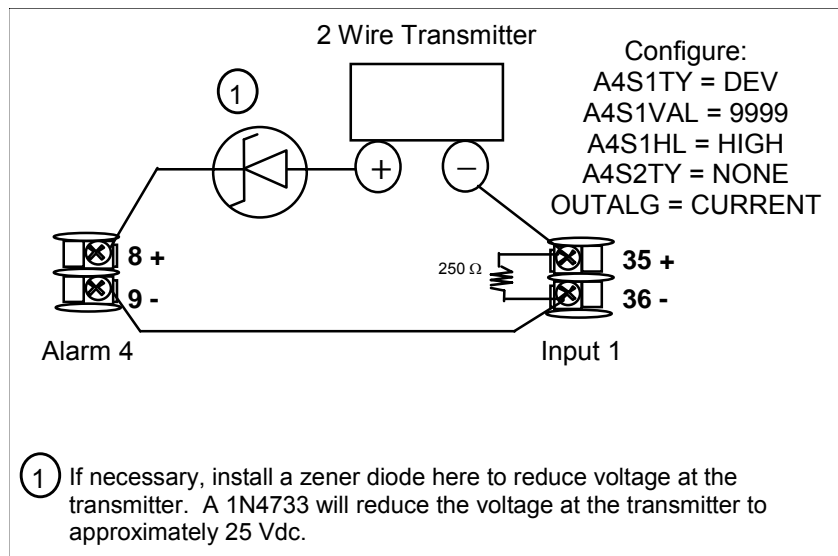

Figure 2-25 Transmitter Power for 4-20 mA — 2 wire Transmitter Using Open Collector Output

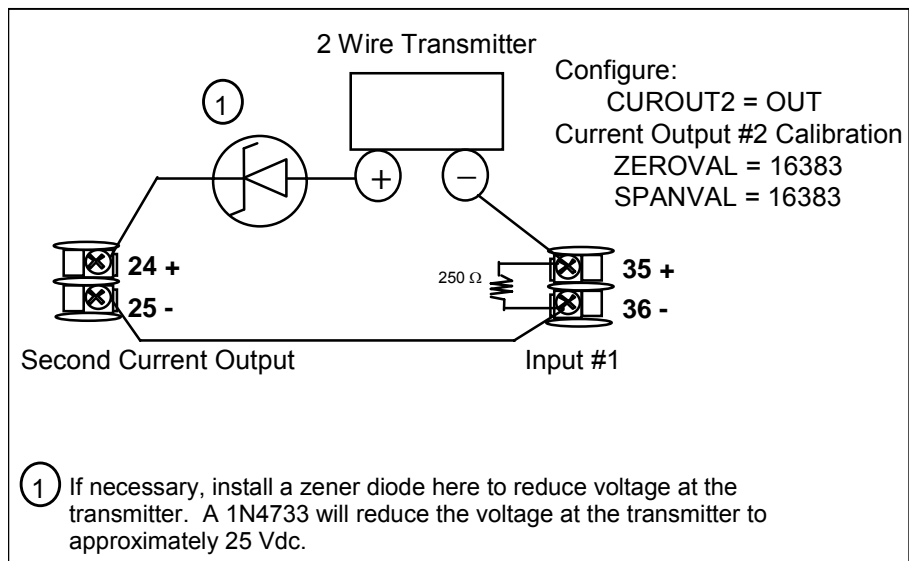

Figure 2-26 Transmitter Power for 4-20 mA — 2 Wire Transmitter Using Second Current Output

3 Configuration

3.1 Overview

Introduction

Configuration is a dedicated operation where you use straightforward keystroke sequences to select and establish (configure) pertinent control data best suited for your application.

To assist you in the configuration process, there are prompts that appear in the upper and lower displays. These prompts let you know what group of configuration data (Set Up prompts) you are working with and also, the specific parameters (Function prompts) associated with each group.

Table 3-1 shows an overview of the prompt hierarchy as it appears in the controller.

What's in this section?

The following topics are covered in this section.

Table 3-1 Configuration Topics

TOPIC	See Page
3.1 Overview	44
3.2 Configuration Prompt Hierarchy	46
3.3 Configuration Procedure	50
3.4 Loop 1 Tuning Set Up Group	51
3.5 Loop 2 Tuning Set Up Group	55
3.6 SP Ramp Set Up Group	58
3.7 SP Program 2 Set Up Group	64
3.8 SP Program 3 Set Up Group	67
3.9 SP Program 4 Set Up Group	70
3.10 Accutune Set Up Group	73
3.11 Algorithm Set Up Group	78
3.12 Math Set Up Group	93
3.13 Logic Gates Set Up Group	99
3.14 Output Set Up Group	106
3.15 Input 1 Set Up Group	117
3.16 Input 2 Set Up Group	121
3.17 Input 3 Set Up Group	124
3.18 Input 4 Set Up Group	127

TOPIC	See Page
3.19 Input 5 Set Up Group	130
3.20 Control Set Up Group	133
3.21 Control 2 Set Up Group	142
3.22 Options Set Up Group	149
3.23 Communications Set Up Group	161
3.24 Alarms Set Up Group	165
3.25 Real Time Clock Set Up Group	173
3.26 Maintenance Set Up Group	174
3.27 Display Set Up Group	177
3.28 Read Maintenance Set Up Group	179
3.29 Time Events Set Up Group	180
3.30 P.I.E. Tool Ethernet and Email Configuration Screens	182
3.31 Configuration Record Sheet	185

3.2 Configuration Prompt Hierarchy

Table 3-2 Configuration Prompt Hierarchy

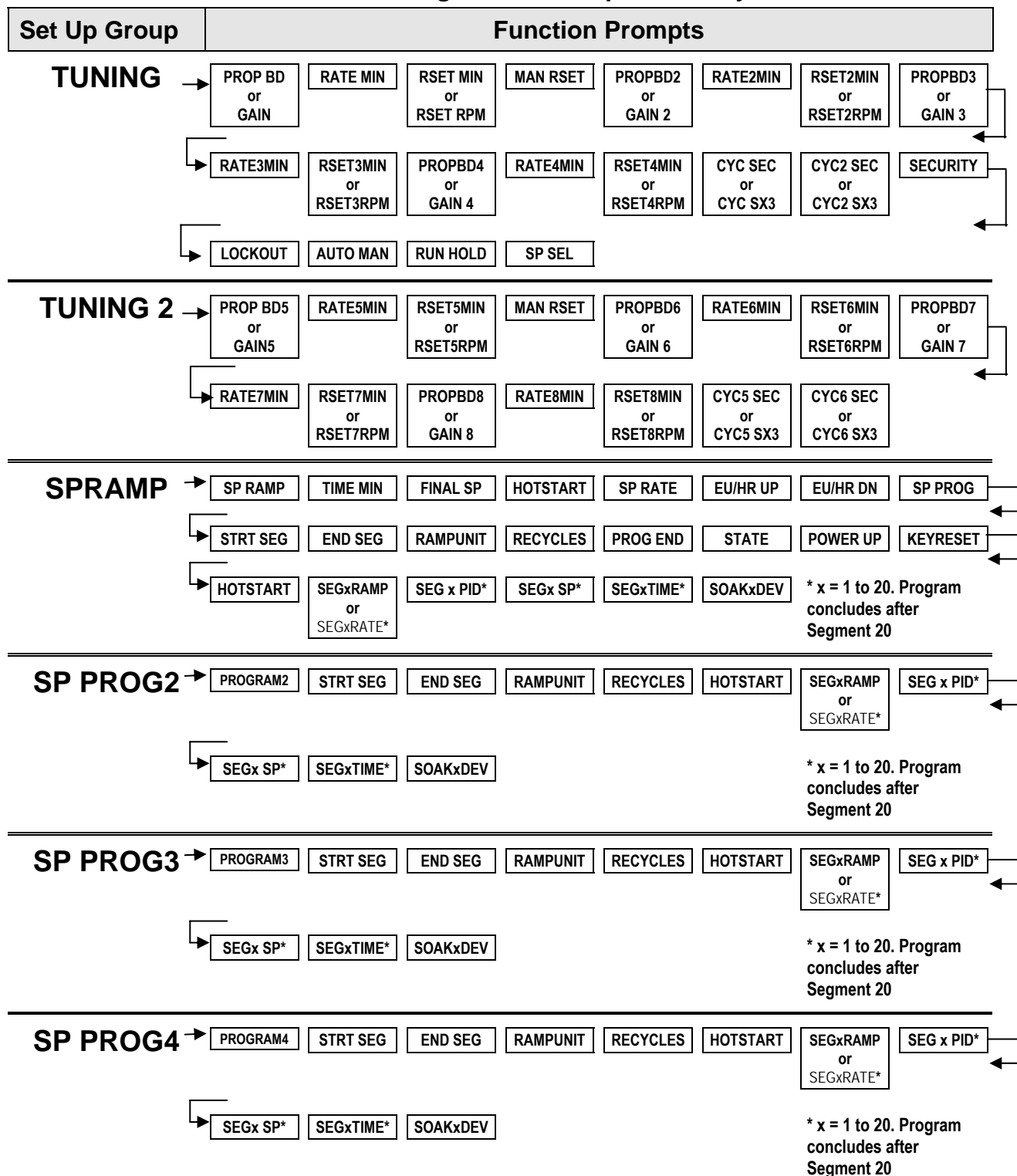

Set Up Group	Function Prompts
ACCUTUNE	FUZZY ACCUTUNE DUPLEX SP CHANGE KPG CRITERIA ACCUTUN2 DUPLEX
	SP CHANG2 KPG2 CRITERIA2 AT ERROR AT ERR 2
ALGORITHM	CONT ALG PIDLOOPS CONT2ALG OUT OVRD TIMER PERIOD START LWR DISP
	RESET INCRMENT INALG 1 MATH K CALC HI CALC LO ALG1 INA ALG1 INB
	ALG1 INC PCO SEL PCT CO PCT H2 ATM PRES ALG1 BIAS INALG 2 MATH K2
	CALC HI CALC LO ALG2 INA ALG2 INB ALG2 INC ALG2 BIAS
MATH	8 SEG CH1 Xn VALUE Yn VALUE 8 SEG CH2 Xn VALUE Yn VALUE TOTALIZE ΣXXXXXX
	TOT SCAL TOT SCR Σ RESET? TOT RATE POLYNOM C0 VALUE C1 VALUE C2 X 10 ⁻¹
	C2 X 10 ⁻³ C2 X 10 ⁻⁴ C2 X 10 ⁻⁵
LOGIC	LOG GATE GATE1TYP GATE1INA GATE1 K GATE1INB GATE1OUT GATE2TYP GATE2 K
	GATE2INB GATE2OUT GATE3TYP GATE3INA GATE3 K GATE3INB GATE3OUT GATE4TYP
	GATE4INA GATE4 K GATE4INB GATE4OUT GATE5TYP GATE5INA GATE5 K GATE5INB
	GATE5OUT
OUTPUT	OUT ALG OUT RNG C1 RANGE RLYSTATE RLY TYPE MOTOR TI OUT2 ALG OUT2 RNG
	C3 RANGE RLYSTAT2 CUR OUT1 LOW VAL HIGH VAL
INPUT1	IN1 TYPE XMITTER1 IN1 HIGH IN1 LOW RATIO 1 BIAS IN1 FILTER 1 BURNOUT1
	EMISSIV1
INPUT2	IN2 TYPE XMITTER2 IN2 HIGH IN2 LOW RATIO 2 BIAS IN2 FILTER 2 BURNOUT2
	EMISSIV2
INPUT3	IN3 TYPE XMITTER3 IN3 HIGH IN3 LOW RATIO 3 BIAS IN3 FILTER 3 BURNOUT3
	EMISSIV3
INPUT4	IN4 TYPE XMITTER4 IN4 HIGH IN4 LOW RATIO 4 BIAS IN4 FILTER 4 BURNOUT4
INPUT5	IN5 TYPE XMITTER5 IN5 HIGH IN5 LOW RATIO 5 BIAS IN5 FILTER 5 BURNOUT5

Set Up Group	Function Prompts							
CONTROL	PV SOURC	PID SETS	SW VAL12	SW VAL23	SW VAL34	LSP'S	RSP SRC	AUTOBIAS
	SP TRACK	PWR MODE	PWR OUT	SP HiLIM	SP LoLIM	ACTION	OUT RATE	PCT/M UP
	PCT/M DN	OUTHILIM	OUTLoLIM	I Hi LIM	I Lo LIM	DROPOFF	DEADBAND	OUT HYST
	FAILMODE	FAILSAFE	SW FAIL	MAN OUT	AUTO OUT	PBorGAIN	MINorRPM	
CONTROL2	PV 2SRC	LINK LPS	PID SETS	SW VAL 12	SW VAL23	SW VAL34	LSP'S	RSP SRC
	AUTOBIAS	SP TRACK	PWRMODE	SP HiLIM	SP LoLIM	ACTION	OUT RATE	PCT/M UP
	PCT/M DN	OUTHILIM	OUTLoLIM	I Hi LIM	I Lo LIM	DROPOFF	DEADBAND	FAILMODE
	FAILSAFE							
OPTIONS	CUR OUT2	C2RANGE	HIGH VAL	LOW VAL	CUR OUT3	C3RANGE	LOW VAL	HIGH VAL
	DIG1 INP	DIG1 COMB	DIG INP2	DIG2 COMB	DIG INP3	DIG INP4	Dion LP2	
COM	Com ADDR	ComSTATE	IR ENABLE	BAUD	TX DELAY	WSFLOAT	SHEDNAB	SHEDTIME
	SHEDMODE	SHEDSP	UNITS	CSP RATO	CSP BIAS	CSP2RATO	CSP2BIAS	LOOPBACK
ALARMS	A1S1TYPE	A1S1 VAL	A1S1 H L	A1S1 EV	A1S2 TYPE	A1S2 VAL	A1S2 H L	A1S2 EV
	ALHYST1	A2S1TYPE	A2S1 VAL	A2S1 H L	A2S1 EV	A2S2TYPE	A2S2 VAL	A2S2 H L
	A2S2 EV	ALHYST2	A3S1TYPE	A3S1 VAL	A3S1 H L	A3S1 EV	A3S2TYPE	A3S2 VAL
	A3S2 H L	A3S2 EV	ALHYST3	A4S1TYPE	A4S1 VAL	A4S1 H L	A4S1 EV	A4S2TYPE
	A4S2 VAL	A4S2 H L	A4S2 EV	ALHYST4	ALM OUT1	BLOCK	DIAGNOST	ALRM MSG
CLOCK	HOURS	MINUTES	SECONDS	YEAR	MONTH	DAY	SET CLK?	ADJUST
MAINTNCE	TIME 1	TIME 2	TIME 3	COUNT 1	COUNT 2	COUNT 3	PASSWORD	RES TYPE
DISPLAY	DECIMAL	DECIMAL2	TEMPUNIT	PWR FREQ	RATIO 2	LANGUAGE	TC DIAGN	IDNUMBER
READ	DAYS 1	HRS:MIN1	DAYS 2	HRS:MIN2	DAYS 3	HRS:MIN3	COUNTS 1	COUNTS 2
MAINTNCE	COUNTS 3							
TIME	EVENT 1	TIME 1	HOUR 1	MINUTE 1	MONTH 1	DAY 1	EVENT 2	TIME 2
	HOUR 2	MINUTE2	MONTH 2	DAY 2				

Set Up Group	Function Prompts
CALIB	→ USED FOR FIELD CALIBRATION
STATUS	→ <input type="checkbox"/> VERSION <input type="checkbox"/> FAILSAFE <input type="checkbox"/> TESTS

3.3 Configuration Procedure

Introduction

Each of the Set Up groups and their functions are pre-configured at the factory. The factory settings are shown in Table 3-4 through Table 3-24. If you want to change any of these selections or values, follow the procedure in Table 3-3. This procedure tells you the keys to press to get to any Set Up group and any associated Function prompt.

Procedure

ATTENTION







The prompting scrolls at a rate of one group every 2/3 seconds when the **SET UP** or **FUNC/LOOP 1/2** key is held in. Also,  or  keys will move group prompts forward or backward twice as fast.

Table 3-3 Configuration Procedure

Step	Operation	Press	Result
1	Enter Set Up Mode	Set Up	<i>Upper Display = SETUP</i> <i>Lower Display = TUNING</i> (This is the first Set Up Group title)
2	Select any Set Up Group	Set Up	Sequentially displays the other Set Up group titles shown in the prompt hierarchy in Table 3-2 Configuration Prompt Hierarchy. You can also use the  or  keys to scan the Set Up groups in both directions. Stop at the Set Up group title that describes the group of parameters you want to configure. Then proceed to the next step.
3	Select a Function Parameter	Func	<i>Upper Display =</i> the current value or selection for the first function prompt of the selected Set Up group. <i>Lower Display =</i> the first Function prompt within that Set Up group. Sequentially displays the other function prompts of the Set Up group you have selected. Stop at the function prompt that you want to change, then proceed to the next step.
4	Change the Value or Selection	 or 	Increments or decrements the value or selection that appears for the selected function prompt. If you change the value or selection of a parameter while in Set Up mode but then decide not to enter it, press the Man/Auto key once. This will recall the original configuration. This "recall" procedure does not work for a Field Calibration process. Field Calibration is a one-way operation.
5	Enter the Value or Selection	Func	Enters value or selection made into memory after another key is pressed.
6	Exit Configuration	Lower Display	Exits configuration mode and returns controller to the same state it was in immediately preceding entry into the Set Up mode. It stores any changes you have made. If you do not press any keys for 30 seconds, the controller times out and reverts to the mode and associated display used prior to entry into Set Up mode.

3.4 Loop 1 Tuning Set Up Group

Introduction

Tuning consists of establishing the appropriate values for the tuning constants you are using so that your controller responds correctly to changes in process variable and setpoint. You can start with predetermined values but you will have to watch the system to see how to modify them. The Accutune feature automatically selects Gain, Rate, and Reset on demand.

There can be as many as four PID sets available for Loop 1.

ATTENTION

Because this group contains functions that have to do with security and lockout, we recommend that you configure this group last, after all other configuration data has been loaded.

Function Prompts

Table 3-4 TUNING Group Function Prompts

Function Prompt Lower Display	Selections or Range of Setting Upper Display	Parameter Definition
PROP BD or GAIN	0.1 to 9999 % or 0.001 to 1000	<p>PROPORTIONAL BAND (simplex) is the percent of the range of the measured variable for which a proportional controller will produce a 100 % change in its output.</p> <p>GAIN is the ratio of output change (%) over the measured variable change (%) that caused it.</p> $G = \frac{100\%}{PB\%}$ <p>where PB is the proportional band (in %)</p> <p>If the PB is 20 %, then the Gain is 5. And, at those settings, a 3 % change in the error signal (SP-PV) will result in a 15 % change in the controller's output due to proportional action. If the Gain is 2, then the PB is 50 %.</p> <p>Also defined as "HEAT" Gain on Duplex models for variations of Heat/Cool applications.</p> <p><i>The selection of Proportional Band or Gain is made in the CONTROL parameter group under prompt PBoRGAIn.</i></p>
RATE MIN	0.00 to 10.00 minutes	<p>RATE action, in minutes, affects the controller's output whenever the deviation is changing; and affects it more when the deviation is changing faster.</p> <p>Also defined as "HEAT" Rate on Duplex models for variations of Heat/Cool applications.</p>

Function Prompt Lower Display	Selections or Range of Setting Upper Display	Parameter Definition
<p>RSET MIN or RSET RPM</p>	<p>0.02 to 50.00</p>	<p>RSET MIN = Reset in Minutes per Repeat RSET RPM = Reset in Repeats per Minute</p> <p>RESET (or Integral Time) adjusts the controller's output in accordance with both the size of the deviation (SP–PV) and the time that it lasts. The amount of the corrective action depends on the value of Gain. The Reset adjustment is measured as how many times proportional action is repeated per minute or how many minutes before one repeat of the proportional action occurs.</p> <p>Used with control algorithm PID-A or PID-B. Also defined as “HEAT” Reset on Duplex models for variations of Heat/Cool applications.</p> <p>ATTENTION The selection of whether Minutes per Repeat or Repeats per Minute is used is made in the CONTROL parameters group under the prompt MINorRPM.</p>
<p>MAN RSET</p>	<p>–100 to +100 (in % output)</p>	<p>MANUAL RESET is only applicable if you use control algorithm PD WITH MANUAL RESET in the Algorithm Set Up group. Because a proportional controller will not necessarily line out at setpoint, there will be a deviation (offset) from setpoint. This eliminates the offset and lets the PV line out at setpoint.</p> <p>ATTENTION Bias is shown on the lower display.</p>
<p>PROPB2 or GAIN 2</p>	<p>0.1 to 9999 % or 0.001 to 1000</p>	<p>PROPORTIONAL BAND 2 or GAIN 2, RATE 2, and RESET 2 parameters are the same as previously described for “Heat” except that they refer to the cool zone tuning constants on duplex models or the second set of PID constants, whichever is pertinent.</p>
<p>RATE2MIN</p>	<p>0.00 to 10.00 minutes</p>	<p>This is the same as above except that it applies to Duplex models for the “COOL” zone of Heat/Cool applications or for the second set of PID constants.</p>
<p>RSET2MIN RSET2RPM</p>	<p>0.02 to 50.00</p>	<p>These are the same as above except that they apply to Duplex models for the “COOL” zone of Heat/Cool applications or for the second set of PID constants.</p>
<p>PROPB3 or GAIN 3</p>	<p>0.1 to 9999 % or 0.001 to 1000</p>	<p>PROPORTIONAL BAND 3 or GAIN 3 parameters are the same as previously described. This prompt appears only when four PID sets are enabled.</p>
<p>RATE3MIN</p>	<p>0.00 to 10.00 minutes</p>	<p>RATE 3 MINUTES parameter is the same as previously described. This prompt appears only when four PID sets are enabled.</p>

Function Prompt Lower Display	Selections or Range of Setting Upper Display	Parameter Definition
RSET3MIN RSET3RPM	0.02 to 50.00	RESET 3 MINUTES or RSET 3 REPEATS PER MINUTE parameters are the same as previously described. This prompt appears only when four PID sets are enabled.
PROPBD4 or GAIN 4	0.1 to 9999 % or 0.001 to 1000	PROPORTIONAL BAND 4 or GAIN 4 , RATE 4 , and RESET 4 parameters are the same as previously described. This prompt appears only when four PID sets are enabled.
RATE4MIN	0.00 to 10.00 minutes	RATE 4 MINUTES parameter is the same as previously described. This prompt appears only when four PID sets are enabled.
RSET4MIN RSET4RPM	0.02 to 50.00	RESET 4 MINUTES or RSET 3 REPEATS PER MINUTE parameters are the same as previously described. This prompt appears only when four PID sets are enabled.
CYC SEC or CYC SX3	1 to 120	CYCLE TIME (HEAT) determines the length of one time proportional output relay cycle. Defined as "HEAT" cycle time for Heat/Cool applications. CYC SEC —Electromechanical relays CYC SX3 —Solid state relays ATTENTION <i>Cycle times are in either second or 1/3-second increments depending upon the configuration of RLY TYPE in the Output Algorithm Set Up group.</i>
CYC2 SEC or CYC2 SX3	1 to 120	CYCLE TIME 2 (COOL) is the same as above except it applies to Duplex models as the cycle time in the "COOL" zone of Heat/Cool applications or for the second set of PID constants. CYC2 SEC —Electromechanical relays CYC2 SX3 —Solid state relays ATTENTION <i>Cycle times are in either second or 1/3-second increments depending upon the configuration of RLY TYPE in the Output Algorithm Set Up group.</i>
SECURITY	0 to 9999	SECURITY CODE —The level of keyboard lockout may be changed in the Set Up mode. Knowledge of a security code may be required to change from one level to another. This configuration should be copied and kept in a secure location. NOTE: The Security Code is for keyboard entry only and is not available via communications. ATTENTION <i>Can only be changed if LOCKOUT selection is NONE.</i>

Function Prompt Lower Display	Selections or Range of Setting Upper Display	Parameter Definition
LOCKOUT	NONE CALIB + CONF + VIEW MAX	<p>LOCKOUT applies to one of the functional groups: Configuration, Calibration, Tuning, or Accutune. DO NOT CONFIGURE UNTIL ALL OTHER CONFIGURATION IS COMPLETE.</p> <p>NONE—No lockout; all groups are read/write.</p> <p>CALIB—All groups are available for read/write except for the Calibration and Keyboard Lockout groups.</p> <p>+ CONF—Tuning, SP Ramp, and Accutune groups are read/write. All other groups are read only. Calibration and Keyboard Lockout groups are not available.</p> <p>+ VIEW—Tuning and Setpoint Ramp parameters are read/write. No other parameters are viewable.</p> <p>MAX—Tuning and Setpoint Ramp parameters are available for read only. No other parameters are viewable.</p>
AUTO MAN	DISABLE ENABLE	<p>MANUAL/AUTO KEY LOCKOUT—Allows you to disable the Manual/Auto key</p> <p>DISABLE ENABLE</p> <p>ATTENTION <i>Can only be viewed if LOCKOUT is configured for NONE.</i></p>
RUN HOLD	DISABLE ENABLE	<p>RUN/HOLD KEY LOCKOUT—Allows you to disable the Run/Hold key, for either SP Ramp or SP Program. <i>The Run/Hold key is never disabled when used to acknowledge a latched alarm 1</i></p> <p>DISABLE ENABLE</p> <p>ATTENTION <i>Can only be viewed if LOCKOUT is configured for NONE.</i></p>
SP SEL	DISABLE ENABLE	<p>SETPOINT SELECT KEY LOCKOUT—Allows you to disable the Setpoint Select key</p> <p>DISABLE ENABLE</p> <p>ATTENTION <i>Can only be viewed if LOCKOUT is configured for NONE.</i></p>

3.5 Loop 2 Tuning Set Up Group

Introduction

Tuning consists of establishing the appropriate values for the tuning constants you are using so that your controller responds correctly to changes in process variable and setpoint. You can start with predetermined values but you will have to watch the system to see how to modify them. The Accutune feature automatically selects Gain, Rate, and Reset on demand.

There can be as many as four PID sets available for Loop 2.

Function Prompts

Table 3-5 TUNING 2 Group Function Prompts

Function Prompt Lower Display	Selections or Range of Setting Upper Display	Parameter Definition
PROP BD5 or GAIN 5	0.1 to 9999 % or 0.001 to 1000	<p>PROPORTIONAL BAND (simplex) is the percent of the range of the measured variable for which a proportional controller will produce a 100 % change in its output.</p> <p>GAIN is the ratio of output change (%) over the measured variable change (%) that caused it.</p> $G = \frac{100\%}{PB\%}$ <p>where PB is the proportional band (in %)</p> <p>If the PB is 20 %, then the Gain is 5. And, at those settings, a 3 % change in the error signal (SP-PV) will result in a 15 % change in the controller's output due to proportional action. If the Gain is 2, then the PB is 50 %.</p> <p>Also defined as "HEAT" Gain on Duplex models for variations of Heat/Cool applications.</p> <p><i>The selection of Proportional Band or Gain is made in the CONTROL parameter group under prompt PBoRGAIn.</i></p>
RATE5MIN	0.00 to 10.00 minutes	<p>RATE action, in minutes, affects the controller's output whenever the deviation is changing; and affects it more when the deviation is changing faster.</p> <p>Also defined as "HEAT" Rate on Duplex models for variations of Heat/Cool applications.</p>

Function Prompt Lower Display	Selections or Range of Setting Upper Display	Parameter Definition
<p>RSET5MIN or RSET5RPM</p>	<p>0.02 to 50.00</p>	<p>RSET5MIN = Reset in Minutes per Repeat RSET5RPM = Reset in Repeats per Minute</p> <p>RESET (or Integral Time) adjusts the controller's output in accordance with both the size of the deviation (SP–PV) and the time that it lasts. The amount of the corrective action depends on the value of Gain. The Reset adjustment is measured as how many times proportional action is repeated per minute or how many minutes before one repeat of the proportional action occurs.</p> <p>Used with control algorithm PID-A or PID-B. Also defined as “HEAT” Reset on Duplex models for variations of Heat/Cool applications.</p> <p>ATTENTION The selection of whether Minutes per Repeat or Repeats per Minute is used is made in the CONTROL2 parameters group under the prompt MINorRPM.</p>
<p>MAN5RSET</p>	<p>–100 to +100 (in % output)</p>	<p>MANUAL5RESET is only applicable if you use control algorithm PD WITH MANUAL RESET for Loop 2 in the Algorithm Set Up group. Because a proportional controller will not necessarily line out at setpoint, there will be a deviation (offset) from setpoint. This eliminates the offset and lets the PV line out at setpoint.</p> <p>ATTENTION Bias is shown on the lower display.</p>
<p>PROPB6 or GAIN 6</p>	<p>0.1 to 9999 % or 0.001 to 1000</p>	<p>PROPORTIONAL BAND 6 or GAIN 6, RATE 6 and RESET 6 parameters are the same as previously described for “Heat” except that they refer to the cool zone tuning constants on duplex models or the second set of PID constants, whichever is pertinent.</p>
<p>RATE6MIN</p>	<p>0.00 to 10.00 minutes</p>	<p>This is the same as above except that it applies to Duplex models for the “COOL” zone of Heat/Cool applications or for the second set of PID constants.</p>
<p>RSET6MIN RSET6RPM</p>	<p>0.02 to 50.00</p>	<p>These are the same as above except that they apply to Duplex models for the “COOL” zone of Heat/Cool applications or for the second set of PID constants.</p>
<p>PROPB7 or GAIN 7</p>	<p>0.1 to 9999 % or 0.001 to 1000</p>	<p>PROPORTIONAL BAND 7 or GAIN 7 parameters are the same as previously described. This prompt appears only when four PID sets are enabled.</p>
<p>RATE7MIN</p>	<p>0.00 to 10.00 minutes</p>	<p>RATE 7 MINUTES parameter is the same as previously described. This prompt appears only when four PID sets are enabled.</p>

Function Prompt Lower Display	Selections or Range of Setting Upper Display	Parameter Definition
RSET7MIN RSET7RPM	0.02 to 50.00	RESET 7 MINUTES or RSET 7 REPEATS PER MINUTE parameters are the same as previously described. This prompt appears only when four PID sets are enabled.
PROPBD8 or GAIN 4	0.1 to 9999 % or 0.001 to 1000	PROPORTIONAL BAND 8 or GAIN 8 , RATE 8 , and RESET 8 parameters are the same as previously described. This prompt appears only when four PID sets are enabled.
RATE8MIN	0.00 to 10.00 minutes	RATE 8 MINUTES parameter is the same as previously described. This prompt appears only when four PID sets are enabled.
RSET8MIN RSET8RPM	0.02 to 50.00	RESET 8 MINUTES or RSET 8 REPEATS PER MINUTE parameters are the same as previously described. This prompt appears only when four PID sets are enabled.
CYC5 SEC or CYC5 SX3	1 to 120	<p>CYCLE TIME (HEAT) determines the length of one time proportional output relay cycle. Defined as “HEAT” cycle time for Heat/Cool applications.</p> <p>CYC5 SEC—Electromechanical relays CYC5 SX3—Solid state relays</p> <p>ATTENTION <i>Cycle times are in either second or 1/3-second increments depending upon the configuration of RLY TYPE in the Output Algorithm Set Up group.</i></p>
CYC6 SEC or CYC6 SX3	1 to 120	<p>CYCLE TIME 2 (COOL) is the same as above except it applies to Duplex models as the cycle time in the “COOL” zone of Heat/Cool applications or for the second set of PID constants.</p> <p>CYC6 SEC—Electromechanical relays CYC6 SX3—Solid state relays</p> <p>ATTENTION <i>Cycle times are in either second or 1/3-second increments depending upon the configuration of RLY TYPE in the Output Algorithm Set Up group.</i></p>

3.6 SP Ramp Set Up Group

Introduction

Set Point Ramp, Set Point Programs and Set Point Rates can be configured in this group.

A single *Setpoint Ramp* [SP RAMP] can be configured to occur between the current local setpoint and a final local setpoint over a time interval of from 1 to 255 minutes.

A *Set Point Rate* [SPRATE] lets you configure a *specific rate of change* for any local setpoint change.

A single *Set Point Program* [SP PROG] with up to 20 segments can be configured.

For more information on Set Point Rate, Ramp and Programming, see Sections 4.27 through 4.30.

You can start and stop the ramp/program using the **RUN/HOLD** key.

PV Hot Start is a configurable feature and means that, at initialization, the setpoint is set to the current PV value and the Ramp or Rate or Program then starts from this value.

Added Features not found in other UDC products:

- Up to Four SP Programs rather than one
- 20 segments instead of 12 in each program
- SP Programs 1 and 2 can be linked to give a SP Program of up to 40 segments
- SP Programs 3 and 4 can be linked to give a SP Program of up to 40 segments
- Guaranteed Soak Settings for each Soak Segment
- PID Set selection for each Segment

Function Prompts

ATTENTION

Please note that the configurations used in SP Program #1 for Program End, Program State, Power Up and Key Reset affect all other SP Programs. For this reason, Program #1 must always be enabled in order to enable Programs #2, 3 and/or 4.

Table 3-6 SPRAMP Group Function Prompts

Function Prompt Lower Display	Selections or Range of Setting Upper Display	Parameter Definition
<p>SP RAMP</p> <p><i>SP Program must be disabled for SP Ramp prompts to appear</i></p>	<p>DISABLE</p> <p>ENABLE</p>	<p>SINGLE SETPOINT RAMP—Make a selection to enable or disable the setpoint ramp function. Make sure you configure a ramp time and a final setpoint value.</p> <p><i>SP Programming must be disabled.</i></p> <p>DISABLE SETPOINT RAMP—Disables the setpoint ramp option.</p> <p>ENABLE SETPOINT RAMP—Allows the single setpoint ramp prompts to be shown.</p>
<p>TIME MIN</p>	<p>0 to 255 minutes</p>	<p>SETPOINT RAMP TIME—Enter the number of minutes desired to reach the final setpoint. A ramp time of “0” implies an immediate change of setpoint.</p>
<p>FINAL SP</p>	<p>Within setpoint limits</p>	<p>SETPOINT RAMP FINAL SETPOINT—Enter the value desired for the final setpoint. The controller will operate at the setpoint set here when ramp is ended.</p> <p>ATTENTION If the ramp is on HOLD, the held setpoint can be changed by the ▲ and ▼ keys. However, the ramp time remaining and original ramp rate is not changed. Therefore, when returning to RUN mode, the setpoint will ramp at the same rate as previous to the local setpoint change and will stop if the final setpoint is reached before the time expires. If the time expires before the final setpoint is reached, it will jump to the final setpoint.</p> <p>ATTENTION SP RAMP and SP RATE will cause the SP portion of Accutune to abort. PV Tune will continue to function normally. Ramp is placed into HOLD while tuning (TUNE configuration).</p>
<p>HOTSTART</p>	<p>DISABLE</p> <p>ENABLE</p>	<p>DISABLE—LSP1 is used as the initial ramp setpoint.</p> <p>ENABLE—Current PV value is used as the initial ramp setpoint.</p>
<p>SP RATE</p> <p><i>SP Rate operates on any LSP when both SP Ramp and SP Programming are not active.</i></p>	<p>DISABLE</p> <p>ENABLE</p>	<p>SETPOINT RATE—Lets you configure a specific rate of change for any local setpoint change.</p> <p>DISABLE SETPOINT RATE—Disables the setpoint rate option.</p> <p>ENABLE SETPOINT RATE—Allows the SP rate feature.</p>

Function Prompt Lower Display	Selections or Range of Setting Upper Display	Parameter Definition
EU/HR UP	0 to 9999 in engineering units per hour	RATE UP —Rate up value. When making a setpoint change, this is the rate at which the controller will change from the original setpoint up to the new one. The ramping (current) setpoint can be viewed as SPn in the lower display. Entering a 0 will imply an immediate step change in Setpoint (i.e., no rate applies).
EU/HR DN	0 to 9999 in engineering units per hour	RATE DOWN —Rate down value. When making a setpoint change, this is the rate at which the controller will change from the original setpoint down to the new one. The ramping (current) setpoint can be viewed as SPn in the lower display. Entering a 0 will imply an immediate step change in Setpoint (i.e., no rate applies).
SP PROG (optional feature) <i>SP Ramp must be disabled for SP Program prompts to appear. If SP Rate is enabled, it does not operate while an SP Program is running.</i>	DISABLE ENABLE ENABLE2 ENABL12	SETPOINT RAMP/SOAK PROGRAM #1 —Available only with controllers that contain this option. <i>SP RAMP must be disabled.</i> DISABLE —Disables all Setpoint Programs. ENABLE —Setpoint Program runs on Loop 1. ENABLE2 —Setpoint Program runs on Loop 2. ENABL12 —Setpoint Program runs on both Loop1 and Loop 2. ATTENTION SP Program #1 must be enabled in order to use SP Programs 2, 3 and 4.
STRT SEG	1 to 20	START SEGMENT NUMBER
END SEG	2 to 20 even numbers Always end in a soak segment (2, 4, ... 20)	END SEGMENT NUMBER ATTENTION When SP Programs 1 and 2 are linked, this parameter does not appear. The value is automatically set to 20 and the End Segment Number is controlled by the selection for End Segment in SP Program #2.
RAMPUNIT	TIME EU/MIN EU/HR	RAMPUNIT —Engineering Units for Ramp Segments TIME in hours: minutes RATE in Engineering units per minute RATE in Engineering units per hour
RECYCLES	0 to 100 recycles	Number of Program Recycles

Function Prompt Lower Display	Selections or Range of Setting Upper Display	Parameter Definition
PROG END	LASTSP F SAFE	<p>PROGRAM TERMINATION STATE</p> <p>LAST SETPOINT—Hold at last setpoint in the program FAIL SAFE—Manual mode/Failsafe output</p> <p>ATTENTION Selection affects all enabled SP Programs.</p>
STATE	DISABLE HOLD	<p>PROGRAM STATE AT PROGRAM END</p> <p>ATTENTION Selection affects all enabled SP Programs.</p>
POWER UP	ABORT RESUME RESTART	<p>POWER UP—This configuration determines what the Program will do in the case of a power outage during the Program. This prompt only appears on those instruments that have the Real Time Clock option.</p> <p>ATTENTION Selection affects all enabled SP Programs.</p> <p>ABORT—Program terminated on power up RESUME—Continue at the same point in program RESTART—Restart program at beginning of the same cycle</p>
KEYRESET	DISABLE ToBEGIN	<p>KEY RESET—Reset/Rerun SP Program</p> <p>DISABLE</p> <p>RESET TO BEGINNING OF SETPOINT PROGRAM—When enabled, this selection allows you to reset via the keyboard to the beginning of the program and resets the Recycle value to 0. The program mode is placed in HOLD.</p> <p>If the current Local Setpoint 1 value is at any value other than that Setpoint value used in the first Soak segment in the program, then the program will restart at the current Local Setpoint 1 value and at the beginning of the first Ramp segment in the program.</p> <p>If the current Local Setpoint 1 value is at the same Setpoint value as that used for the first Soak segment in the program, then the first Ramp segment is skipped and the program will restart at the beginning of the first Soak segment in the program.</p> <p>ATTENTION Selection affects all enabled SP Programs.</p>

Function Prompt Lower Display	Selections or Range of Setting Upper Display	Parameter Definition
	RERUN	RERUN CURRENT CYCLE —When enabled, this selection allows you to reset the program via the keyboard to the beginning of the current cycle. The Recycle value is not affected. The program mode (RUN or HOLD) is not affected.
HOTSTART	DISABLE ENABLE	HOT START —This feature allows the SP Program to start at the current PV value rather than the current Setpoint value.
SEG1RAMP or SEG1RATE	0-99 hours.0-59 minutes Engineering units/minute or Engineering units/hour	Segment #1 Ramp Time or Segment #1 Ramp Rate ATTENTION This parameter is affected by the RAMPUNIT configuration (see above). All ramps will use the same selection.
SEG1PID	1-4	PID Set Selection ATTENTION The PID Set Selection prompts will only show up when PID SETS in the Control 1 or Control 2 Setup Group is set to 4 KEYBD. See Section 3.20 (Control 1) and Section 3.21 (Control 2).
SEG2 SP	Within the Setpoint limits	Segment #2 Soak Setpoint Value
SEG2TIME	0-99 hours.0-59 minutes	Segment #2 Soak Duration
SOAK2DEV	0.000 to 99.99	Guaranteed Soak Deviation Value For Soak Segment #2 —The number selected will be the PV value (in engineering units) above and below the setpoint outside of which the Soak Segment timer halts. A value of 0.000 is equivalent to no Guaranteed Soak.
SEG2 PID	1-4	PID Set Selection —This selection is Loop dependent. ATTENTION The PID Set Selection prompts will only show up when PID SETS in the Control 1 or Control 2 Setup Group is set to 4 KEYBD. See Section 3.20 (Control 1) and Section 3.21 (Control 2).
SEG3RAMP or SEG3RATE SEG3 PID SEG4 SP SEG4TIME SOAK4DEV SEG4 PID SEG5RAMP or SEG5RATE SEG5 PID SEG6 SP SEG6TIME	Selections are same as above.	Same as above

Function Prompt Lower Display	Selections or Range of Setting Upper Display	Parameter Definition
<p>SOAK6DEV SEG6 PID</p> <p>SEG7RAMP or SEG7RATE SEG7 PID</p> <p>SEG8 SP SEG8TIME SOAK8DEV SEG8 PID</p> <p>SEG9RAMP or SEG9RATE SEG9 PID</p> <p>SG10 SP SG10TIME SOAK10DEV SG10 PID</p> <p>SG11RAMP or SG11RATE SG11 PID</p> <p>SG12 SP SG12TIME SOAK12DEV SG12 PID</p> <p>SG13RAMP or SG13RATE SG13 PID</p> <p>SG14 SP SG14TIME SOAK14DEV SG14 PID</p> <p>SG15RAMP or SG15RATE SG15 PID</p> <p>SG16 SP SG16TIME SOAK16DEV SG16 PID</p> <p>SG17RAMP or SG17RATE SG17 PID</p> <p>SG18 SP SG18TIME SOAK18DEV SG18 PID</p> <p>SG19RAMP or SG19RATE SG19 PID</p> <p>SG20 SP SG20TIME SOAK20DEV SG20 PID</p>		

3.7 SP Program 2 Set Up Group

Introduction

An optional second SetPoint Program. SP Programs #1 and #2 can be linked together to form a single, longer SP Program.

ATTENTION

Please note that the configurations used in SP Program #1 for Program End, Program State, Power Up and Key Reset affect all other SP Programs. For this reason, Program #1 must always be enabled in order to enable Programs #2, 3 and/or 4.

Function Prompts

Table 3-7 SP PROG2 Group Function Prompts

Function Prompt Lower Display	Selections or Range of Setting Upper Display	Parameter Definition
<p>SP PROG2 (optional feature)</p> <p><i>SP Ramp must be disabled for SP Program prompts to appear. If SP Rate is enabled, it does not operate while an SP Program is running.</i></p>	<p>DISABLE ENABLE ENABLE2 ENABL12</p> <p>LINK</p>	<p>SETPOINT RAMP/SOAK PROGRAM #2—Available only with controllers that contain this option.</p> <p><i>SP RAMP must be disabled.</i></p> <p>DISABLE—Disables setpoint programming. ENABLE—Enables setpoint programming—Loop 1. ENABLE2—Enables setpoint programming—Loop 2. ENABL12—Enables setpoint programming—Both Loop1 and Loop 2. LINK—Programs 1 and 2 are linked</p>
<p>STRT SEG</p>	<p>1 to 20</p>	<p>START SEGMENT NUMBER</p> <p>ATTENTION When SP Programs 1 and 2 are linked, this prompt does not appear and this value is automatically set to 1</p>
<p>END SEG</p>	<p>2 to 20 even numbers Always end in a soak segment (2, 4, ... 20)</p>	<p>END SEGMENT NUMBER</p> <p>ATTENTION When linking Setpoint Programs 1 and 2, this End Segment Number determines the end of the entire linked program.</p>
<p>RAMPUNIT</p>	<p>TIME EU/MIN EU/HR</p>	<p>RAMPUNIT—Engineering Units for Ramp Segments</p> <p>TIME in hours: minutes RATE in Engineering units per minute RATE in Engineering units per hour</p> <p>ATTENTION Normally the same as Program #1 when linking programs.</p>
<p>RECYCLES</p>	<p>0 to 100 recycles</p>	<p>Number of Program Recycles</p>

Function Prompt Lower Display	Selections or Range of Setting Upper Display	Parameter Definition
HOTSTART	DISABLE ENABLE	HOT START —This feature allows the SP Program to start at the current PV value rather than the current Setpoint value. ATTENTION Not used when linking programs
SEG1RAMP or SEG1RATE	0-99 hours.0-59 minutes Engineering units/minute or Engineering units/hour	Segment #1 Ramp Time or Segment #1 Ramp Rate ATTENTION This parameter is affected by the RAMPUNIT configuration (see above). All ramps will use the same selection.
SEG1PID	1-4	PID Set Selection ATTENTION The PID Set Selection prompts will only show up when PID SETS in the Control 1 or Control 2 Setup Group is set to 4 KEYBD.
SEG2 SP	Within the Setpoint limits	Segment #2 Soak Setpoint Value
SEG2TIME	0-99 hours.0-59 minutes	Segment #2 Soak Duration
SOAK2DEV	0.000 to 99.99	Guaranteed Soak Deviation Value For Soak Segment #2 —The number selected will be the PV value (in engineering units) above and below the setpoint outside of which the Soak Segment timer halts. A value of 0.000 is equivalent to no Guaranteed Soak.
SEG2 PID	1-4	PID Set Selection —This selection is Loop dependent. ATTENTION The PID Set Selection prompts will only show up when PID SETS in the Control 1 or Control 2 Setup Group is set to 4 KEYBD.
SEG3RAMP or SEG3RATE SEG3 PID SEG4 SP SEG4TIME SOAK4DEV SEG4 PID SEG5RAMP or SEG5RATE SEG5 PID SEG6 SP SEG6TIME SOAK6DEV SEG6 PID SEG7RAMP or SEG7RATE	Selections are same as above.	Same as above

Function Prompt Lower Display	Selections or Range of Setting Upper Display	Parameter Definition
<p> SEG7 PID SEG8 SP SEG8TIME SOAK8DEV SEG8 PID SEG9RAMP or SEG9RATE SEG9 PID SG10 SP SG10TIME SOAK10DEV SG10 PID SG11RAMP or SG11RATE SG11 PID SG12 SP SG12TIME SOAK12DEV SG12 PID SG13RAMP or SG13RATE SG13 PID SG14 SP SG14TIME SOAK14DEV SG14 PID SG15RAMP or SG15RATE SG15 PID SG16 SP SG16TIME SOAK16DEV SG16 PID SG17RAMP or SG17RATE SG17 PID SG18 SP SG18TIME SOAK18DEV SG18 PID SG19RAMP or SG19RATE SG19 PID SG20 SP SG20TIME SOAK20DEV SG20 PID </p>		

3.8 SP Program 3 Set Up Group

Introduction

An optional third SetPoint Program. SP Programs #3 and #4 can be linked together to form a single, longer SP Program.

ATTENTION

Please note that the configurations used in SP Program #1 for Program End, Program State, Power Up and Key Reset affect all other SP Programs. For this reason, Program #1 must always be enabled in order to enable Programs #2, 3 and/or 4.

Function Prompts

Table 3-8 SP PROG3 Group Function Prompts

Function Prompt Lower Display	Selections or Range of Setting Upper Display	Parameter Definition
<p>SP PROG3 (optional feature)</p> <p><i>SP Ramp must be disabled for SP Program prompts to appear. If SP Rate is enabled, it does not operate while an SP Program is running.</i></p>	<p>DISABLE ENABLE ENABLE2 ENABL12</p>	<p>SETPOINT RAMP/SOAK PROGRAM #3—Available only with controllers that contain this option.</p> <p><i>SP RAMP must be disabled.</i></p> <p>DISABLE—Disables setpoint programming. ENABLE—Enables setpoint programming—Loop 1. ENABLE2—Enables setpoint programming—Loop 2. ENABL12—Enables setpoint programming—Both Loop1 and Loop 2.</p>
STRT SEG	1 to 20	START SEGMENT NUMBER
END SEG	2 to 20 even numbers Always end in a soak segment (2, 4, ... 20)	<p>END SEGMENT NUMBER</p> <p>ATTENTION When SP Programs 3 and 4 are linked, this parameter does not appear. The value is automatically set to 20 and the End Segment Number is controlled by the selection for End Segment in SP Program #4.</p>
RAMPUNIT	<p>TIME EU/MIN EU/HR</p>	<p>RAMPUNIT—Engineering Units for Ramp Segments</p> <p>TIME in hours: minutes RATE in Engineering units per minute RATE in Engineering units per hour</p>
RECYCLES	0 to 100 recycles	<p>Number of Program Recycles</p> <p>ATTENTION Not used when linking programs</p>
HOTSTART	<p>DISABLE ENABLE</p>	<p>HOT START—This feature allows the SP Program to start at the current PV value rather than the current Setpoint value.</p>

Function Prompt Lower Display	Selections or Range of Setting Upper Display	Parameter Definition
SEG1RAMP or SEG1RATE	0-99 hours.0-59 minutes Engineering units/minute or Engineering units/hour	Segment #1 Ramp Time or Segment #1 Ramp Rate ATTENTION This parameter is affected by the RAMPUNIT configuration (see above). All ramps will use the same selection.
SEG1PID	1-4	PID Set Selection ATTENTION The PID Set Selection prompts will only show up when PID SETS in the Control 1 or Control 2 Setup Group is set to 4 KEYBD.
SEG2 SP	Within the Setpoint limits	Segment #2 Soak Setpoint Value
SEG2TIME	0-99 hours.0-59 minutes	Segment #2 Soak Duration
SOAK2DEV	0.000 to 99.99	Guaranteed Soak Deviation Value For Soak Segment #2 —The number selected will be the PV value (in engineering units) above and below the setpoint outside of which the Soak Segment timer halts. A value of 0.000 is equivalent to no Guaranteed Soak.
SEG2 PID	1-4	PID Set Selection —This selection is Loop dependent. ATTENTION The PID Set Selection prompts will only show up when PID SETS in the Control 1 or Control 2 Setup Group is set to 4 KEYBD.
SEG3RAMP or SEG3RATE SEG3 PID SEG4 SP SEG4TIME SOAK4DEV SEG4 PID SEG5RAMP or SEG5RATE SEG5 PID SEG6 SP SEG6TIME SOAK6DEV SEG6 PID SEG7RAMP or SEG7RATE SEG7 PID SEG8 SP SEG8TIME SOAK8DEV SEG8 PID	Selections are same as above.	Same as above ATTENTION When linking programs, all 20 segments in Program 3 MUST be used.

Function Prompt Lower Display	Selections or Range of Setting Upper Display	Parameter Definition
<p> SEG9RAMP or SEG9RATE SEG9 PID SG10 SP SG10TIME SOAK10DEV SG10 PID SG11RAMP or SG11RATE SG11 PID SG12 SP SG12TIME SOAK12DEV SG12 PID SG13RAMP or SG13RATE SG13 PID SG14 SP SG14TIME SOAK14DEV SG14 PID SG15RAMP or SG15RATE SG15 PID SG16 SP SG16TIME SOAK16DEV SG16 PID SG17RAMP or SG17RATE SG17 PID SG18 SP SG18TIME SOAK18DEV SG18 PID SG19RAMP or SG19RATE SG19 PID SG20 SP SG20TIME SOAK20DEV SG20 PID </p>		

3.9 SP Program 4 Set Up Group

Introduction

An optional fourth SetPoint Program. SP Programs #3 and #4 can be linked together to form a single, longer SP Program.

ATTENTION

Please note that the configurations used in SP Program #1 for Program End, Program State, Power Up and Key Reset affect all other SP Programs. For this reason, Program #1 must always be enabled in order to enable Programs #2, 3 and/or 4.

Enabling SP Program 4 automatically disables the characterizers in the Math Setup Group.

Function Prompts

Table 3-9 SP PROG4 Group Function Prompts

Function Prompt Lower Display	Selections or Range of Setting Upper Display	Parameter Definition
<p>SP PROG4 (optional feature)</p> <p><i>SP Ramp must be disabled for SP Program prompts to appear. If SP Rate is enabled, it does not operate while an SP Program is running.</i></p>	<p>DISABLE ENABLE ENABLE2 ENABL12</p> <p>LINK</p>	<p>SETPOINT RAMP/SOAK PROGRAM #2—Available only with controllers that contain this option.</p> <p><i>SP RAMP must be disabled.</i></p> <p>DISABLE—Disables setpoint programming. ENABLE—Enables setpoint programming—Loop 1. ENABLE2—Enables setpoint programming—Loop 2. ENABL12—Enables setpoint programming—Both Loop1 and Loop 2. LINK—Programs 3 and 4 are linked</p>
<p>STRT SEG</p>	<p>1 to 20</p>	<p>START SEGMENT NUMBER</p> <p>ATTENTION When SP Programs 3 and 4 are linked, this prompt does not appear and this value is automatically set to 1.</p>
<p>END SEG</p>	<p>2 to 20 even numbers Always end in a soak segment (2, 4, ... 20)</p>	<p>END SEGMENT NUMBER</p> <p>ATTENTION When linking Setpoint Programs 3 and 4, this End Segment Number determines the end of the entire linked program.</p>
<p>RAMPUNIT</p>	<p>TIME EU/MIN EU/HR</p>	<p>RAMPUNIT—Engineering Units for Ramp Segments</p> <p>TIME in hours: minutes RATE in Engineering units per minute RATE in Engineering units per hour</p> <p>ATTENTION Normally the same as Program #3 when linking programs.</p>

Function Prompt Lower Display	Selections or Range of Setting Upper Display	Parameter Definition
RECYCLES	0 to 100 recycles	Number of Program Recycles
HOTSTART	DISABLE ENABLE	HOT START —This feature allows the SP Program to start at the current PV value rather than the current Setpoint value. ATTENTION Not used when linking programs.
SEG1RAMP or SEG1RATE	0-99 hours.0-59 minutes Engineering units/minute or Engineering units/hour	Segment #1 Ramp Time or Segment #1 Ramp Rate ATTENTION This parameter is affected by the RAMPUNIT configuration (see above). All ramps will use the same selection.
SEG1PID	1-4	PID Set Selection ATTENTION The PID Set Selection prompts will only show up when PID SETS in the Control 1 or Control 2 Setup Group is set to 4 KEYBD.
SEG2 SP	Within the Setpoint limits	Segment #2 Soak Setpoint Value
SEG2TIME	0-99 hours.0-59 minutes	Segment #2 Soak Duration
SOAK2DEV	0.000 to 99.99	Guaranteed Soak Deviation Value For Soak Segment #2 —The number selected will be the PV value (in engineering units) above and below the setpoint outside of which the Soak Segment timer halts. A value of 0.000 is equivalent to no Guaranteed Soak.
SEG2 PID	1-4	PID Set Selection —This selection is Loop dependent. ATTENTION The PID Set Selection prompts will only show up when PID SETS in the Control 1 or Control 2 Setup Group is set to 4 KEYBD.
SEG3RAMP or SEG3RATE SEG3 PID SEG4 SP SEG4TIME SOAK4DEV SEG4 PID SEG5RAMP or SEG5RATE SEG5 PID SEG6 SP SEG6TIME SOAK6DEV SEG6 PID SEG7RAMP or	Selections are same as above.	Same as above

Function Prompt Lower Display	Selections or Range of Setting Upper Display	Parameter Definition
<p> SEG7RATE SEG7 PID SEG8 SP SEG8TIME SOAK8DEV SEG8 PID SEG9RAMP or SEG9RATE SEG9 PID SG10 SP SG10TIME SOAK10DEV SG10 PID SG11RAMP or SG11RATE SG11 PID SG12 SP SG12TIME SOAK12DEV SG12 PID SG13RAMP or SG13RATE SG13 PID SG14 SP SG14TIME SOAK14DEV SG14 PID SG15RAMP or SG15RATE SG15 PID SG16 SP SG16TIME SOAK16DEV SG16 PID SG17RAMP or SG17RATE SG17 PID SG18 SP SG18TIME SOAK18DEV SG18 PID SG19RAMP or SG19RATE SG19 PID SG20 SP SG20TIME SOAK20DEV SG20 PID </p>		

3.10 Accutune Set Up Group

Introduction

Accutune III automatically calculates GAIN, RATE, and RESET TIME (PID) tuning constants for your control loop. When initiated on demand, the Accutune algorithm measures a process step response and automatically generates the PID tuning constants needed for no overshoot on your process.

The *Accutune III* set up group offers these selections:

Fuzzy, Fuzzy Overshoot Suppression: When enabled, this configuration will suppress or eliminate any overshoot that may occur as a result of the existing tuning parameters, as the PV approaches the setpoint.

Tune, Demand Tuning: This tuning cycles the output to the output limits causing the PV to oscillate around the SP value. This tuning does not require the process to be at lineout (stabilized) and may be moving. The tuning process is initiated through the operator interface keys or via a digital input (if configured). The algorithm then calculates new tuning parameters and enters them in the tuning group. *Tune* will operate with PIDA, PIDB, PD+MR and Three Position Step Control algorithms.

SP, SP Tuning: When activated in automatic control, the output makes an output step in the direction of the SP and starts measurement activities to calculate the tuning parameters based on the PV response. In order to work properly, this tuning requires that the process be at lineout (stabilized) for a period before SP Tune is initiated.

SP tuning continuously adjusts the PID parameters in response to setpoint changes. You can select tuning on minimum setpoint changes of 5 % up to 15 % span. Perform SP tuning after you have configured the controller. SP Tuning does not operate with the Three Position Step Control algorithm.

Tune + PV or SP + PV, PV Tuning: The (TUNE) Demand Tuning or the (SP) Setpoint Tuning portions of these selections work as stated above. PV Adapt will occur during Process Variable (PV) disturbances (0.3% span or larger) which result from nonlinearities, process dynamics, load changes, or other operating conditions. When this condition exists, the controller monitors the process response for 1 and 1/2 process cycles around the setpoint to determine whether there has been a true process change or a momentary upset.

Process retuning occurs as the process dynamics are learned. When the process is being learned with possible retune, a “t” is shown in the upper left display digit.

Simplex Tuning is used when a Simplex Control Algorithm is configured and uses the current SP value and alters the output over the Output Limit Range.

Duplex Tuning is used when a Duplex Control Algorithm is configured. To perform a Duplex Tune, Two Local Setpoints must be configured per the Control Group in Section 3.20.

See Section 4.10 for additional information.

Function Prompts

Table 3-10 ACCUTUNE Group Function Prompts

Function Prompt Lower Display	Selections or Range of Setting Upper Display	Parameter Definition
FUZZY	<p>DISABLE</p> <p>ENABLE</p> <p>ENABLE2</p> <p>ENABL12</p>	<p>FUZZY OVERSHOOT SUPPRESSION—Can be enabled or disabled independently of whether Demand Tuning or SP Tuning is enabled or disabled.</p> <p>DISABLE—Disables Fuzzy Overshoot Suppression.</p> <p>ENABLE—The instrument uses Fuzzy Logic to suppress or minimize any overshoot that may occur when PV approaches SP. It will not recalculate any new tuning parameters.</p> <p>ENABLE ON LOOP2 ONLY—Fuzzy Tune used only on Loop 2.</p> <p>ENABLE ON BOTH LOOPS—Fuzzy Tune used on both loops.</p>
ACCUTUNE	<p>DISABLE</p> <p>TUNE</p> <p>SP</p>	<p>ACCUTUNE III</p> <p>DISABLE—Disables the Accutune function.</p> <p>DEMAND TUNING—If TUNE is selected, and tuning is initiated through the operator interface or digital input (if configured), the algorithm calculates new tuning parameters and enters them into the tuning group. This tuning requires no process knowledge and does not require line out for initialization.</p> <p>TUNE is the recommended start-up mode—to be used when no knowledge of the process tuning values is available. In the Start-up mode, after enabling ACCUTUNE, the operator simply configures the desired SP value and enables the ACCUTUNE process via the keyboard.</p> <p>SETPOINT TUNING—This selection tunes on setpoint changes only. It employs time domain analysis to accelerate line out at any desired setpoint without prior initialization or process knowledge. This method should only be used after the process has lined out (stabilized).</p> <p>ATTENTION When SP Tune is active (T displayed) the Tuning Group parameters cannot be changed.</p>

Function Prompt Lower Display	Selections or Range of Setting Upper Display	Parameter Definition
	<p>TUNE+PV</p> <p>SP+PV</p>	<p>DEMAND TUNING PLUS PV ADAPTIVE TUNING—This selection provides “TUNE” on demand tuning plus PV Adaptive tuning whenever a PV process disturbance equal to or greater than 0.3% of span occurs. After a disturbance of 1.5 process cycles around the Setpoint occurs, this selection will initiate a recalculation of the Tuning parameters.</p> <p>SETPOINT TUNING PLUS PV ADAPTIVE TUNING—This selection tunes whenever the SP is changed plus performs a PV Adaptive Tune whenever a PV process disturbance equal to or greater than 0.3% of span occurs. After a disturbance of 1.5 process cycles around the Setpoint occurs, this selection will initiate a recalculation of the Tuning parameters.</p> <p>ATTENTION When SP Tune is active (T displayed) the Tuning Group parameters cannot be changed.</p>
<p>DUPLEX</p>	<p>MANUAL</p> <p>AUTO</p> <p>DISABLE</p>	<p>DUPLEX ACCUTUNING III—These prompts only appear when a duplex output type has been configured and TUNE or TUNE+PV has been selected.</p> <p>MANUAL—Tune manually using LSP 1 and LSP 2 values. LSP 1 is used to derive tuning parameters associated with HEAT (output > 50 %). LSP 2 is used to derive tuning parameters associated with COOL (output < 50 %).</p> <p>AUTOMATIC—Tuning is performed automatically on both HEAT and COOL sequentially. LSP 1 is used for HEAT tuning and LSP 2 is used for COOL tuning. To initiate tuning, either LSP 1 or LSP 2 must be in use.</p> <p>DISABLE—The current Setpoint is used to derive a single set of blended tuning parameters. This tuning is performed over the range of the output limits similar to Simplex Tuning. The Tuning Parameters derived are placed into both the HEAT and COOL tune sets (PID 1 and PID 2).</p>
<p>SP CHANG</p>	<p>5 to 15%</p>	<p>SETPOINT CHANGE—This prompt appears only when SP or SP+PV has been selected. This is the minimum Setpoint change on Loop 1 that will result in a re-tuning process.</p> <p>For example, if the SP range is 0 to 2400 and Setpoint change is set to 5%, then a re-tuning process will take place whenever the SP is changed by 120 or more.</p>

Function Prompt Lower Display	Selections or Range of Setting Upper Display	Parameter Definition
KPG	0.10 to 10.00	<p>PROCESS GAIN—This prompt appears only when SP or SP+PV has been selected. This is the Gain of the Loop 1 process being tuned. It is automatically recalculated during the tuning process. This is normally a READ ONLY value, but can be changed manually if the controller fails to identify the process. In that case, set the KPG value to the algebraic value of PV in percent divided by the output in percent while in manual mode.</p> <p>For example, if the PV range is 0 to 2400, the PV is currently at 1200 and the output is currently at 50.0%, then KPG should be set to $1200/2400 * 100/50$ or 1.0.</p>
CRITERIA	NORMAL FAST	<p>TUNING CRITERIA (SETPOINT ADAPTIVE)—This prompt appears only when SP or SP+PV has been selected. Select criteria best suited for your process.</p> <p>NORMAL—Original critical damping (no overshoot).</p> <p>FAST—A more aggressive tuning with overshoot equal to or less than 0.5%.</p>
ACCUTUNE2	Same selections as for Loop 1.	<p>ACCUTUNE III FOR LOOP 2—Available only when the instrument is configured for Cascade or Two Loop operation.</p> <p>Same selections as for Loop 1.</p>
DUPLEX 2	Same selections as for Loop 1.	<p>DUPLEX ACCUTUNING III FOR LOOP 2—These prompts only appear when a duplex output type has been configured for Loop 2 and TUNE or TUNE+PV has been selected.</p> <p>Same selections as for Loop 1.</p>
SP CHAN2	5 to 15%	<p>SETPOINT CHANGE—This prompt appears only when SP or SP+PV has been selected for Loop 2. This is the minimum Setpoint change on Loop 2 that will result in a re-tuning process.</p>
KPG 2	0.10 to 10.00	<p>PROCESS GAIN FOR LOOP 2—This prompt appears only when SP or SP+PV has been selected. This is the Gain of the Loop 2 process being tuned.</p>
CRITERA2	Same selections as for Loop 1.	<p>TUNING CRITERIA (SETPOINT ADAPTIVE) FOR LOOP 2—This prompt appears only when SP or SP+PV has been selected for Loop 2.</p> <p>Same selections as for Loop 1.</p>

Function Prompt Lower Display	Selections or Range of Setting Upper Display	Parameter Definition
<p>AT ERROR (Read Only)</p>	<p>NONE</p> <p>RUNNING</p> <p>ABORT</p> <p>SP2</p> <p>OUTLIM</p> <p>IDFAIL</p> <p>LOW PV</p>	<p>ACCUTUNE ERROR STATUS—When an error is detected in the Accutune process, an error prompt will appear.</p> <p>NONE—No errors occurred during last Accutune procedure.</p> <p>RUNNING—An Accutune process is still active checking process gain, even though “T” is not lit. It does not affect keyboard operation.</p> <p>CURRENT ACCUTUNE PROCESS ABORTED—Caused by one of the following conditions:</p> <ul style="list-style-type: none"> • changing to manual mode • input detected • heat region of output but a cool output was calculated, or vice versa • SP was changed while PV (error) tune was in process <p>SP2—LSP2 not configured or a Setpoint other than LSP1 or LSP2 is in use.</p> <p>OUTPUT LIMIT REACHED (HIGH OR LOW)—Applies only to SP or SP+PV tuning. Output insufficient to get to SP value.</p> <p>ATTENTION This error will cause the controller to switch from Automatic to Manual Mode. The output is then set to the value present at the beginning of the ACCUTUNE process.</p> <p>PROCESS IDENTIFICATION PROCESS FAILED—Applies only to SP or SP+PV tuning. An illegal value for Gain, Rate or Reset was calculated.</p> <p>LOW PV—Applies only to SP or SP+PV tuning. PV did not change sufficiently or the PV has increased by more than 4% but Deadtime was not determined.</p>
<p>AT ERR 2 (Read Only)</p>	<p>Same as Loop 1.</p>	<p>ACCUTUNE ERROR STATUS FOR LOOP 2</p>

3.11 Algorithm Set Up Group

Introduction

This data deals with various control algorithms and Timer functions.

The Timer section allows you to configure a time-out period and to select the timer start by either the keyboard (**RUN/HOLD** key) or Alarm 2. An optional digital input can also be configured to the start the timer. The timer display is selectable as either “time remaining” (*see TI REM*) or “elapsed time” (*see E TIME*).

Alarm 1 is activated at the end of the time-out period. When the timer is enabled, it has exclusive control of the alarm 1 relay—any previous alarm 1 configuration is ignored. At time-out, the timer is ready to be activated again by whatever action has been configured.

Function Prompts

Table 3-11 ALGORITHM Group Function Prompts

Function Prompt Lower Display	Selections or Range of Setting Upper Display	Parameter Definition
<p>CONT ALG</p>	<p>ON-OFF</p>	<p>CONTROL ALGORITHM FOR LOOP 1—The Control Algorithm lets you select the type of control that is best for your process.</p> <p>ON/OFF—The simplest control type. The output can be either ON (100 %) or OFF (0 %). The Process Variable (PV) is compared with the setpoint (SP) to determine the sign of the error (ERROR = PV–SP). The ON/OFF algorithm operates on the sign of the error signal.</p> <p>In Direct Acting Control, when the error signal is positive, the output is 100 %; and when the error signal is negative, the output is 0 %. If the control action is reverse, the opposite is true. An adjustable overlap (Hysteresis Band) is provided between the on and off states.</p> <p>ATTENTION <i>Other prompts affected: OUT HYST</i></p> <p>DUPLEX ON/OFF—This is an extension of the ON-OFF algorithm when the output is configured for a Duplex control algorithm. It allows the operation of a second ON/OFF output. There is a deadband between the operating ranges of the two inputs and an adjustable overlap (hysteresis) of the on and off states of each output. Both Deadband and Hysteresis are separately adjustable. With no relay action the controller will read 50 %.</p> <p>ATTENTION <i>Other prompts affected: OUT HYST and DEADBAND</i></p>

Function Prompt Lower Display	Selections or Range of Setting Upper Display	Parameter Definition
	<p>PID A</p> <p>ATTENTION PID A should not be used for Proportional only action; i.e., no integral (reset) action. Instead, use PD+MR with rate set to 0.</p> <p>PID B</p> <p>PD+MR</p>	<p>PID A—This normally used for three-mode control. Three mode control means that the output can be adjusted to be at any point between 0 % and 100 %. It applies all three control actions—Proportional (P), Integral (I), and Derivative (D)—to the error signal.</p> <p>Proportional (Gain)—Regulates the controller’s output in proportion to the error signal (the difference between Process Variable and Setpoint).</p> <p>Integral (Reset)—Regulates the controller’s output to the size of the error and the time the error has existed. (The amount of corrective action depends on the value of proportional Gain.)</p> <p>Derivative (Rate)—Regulates the controller’s output in proportion to the rate of change of the error. (The amount of corrective action depends on the value of proportional Gain.)</p> <p>PID B—Unlike the PID A equation, the controller gives only an integral response to a setpoint change, with no effect on the output due to the gain or rate action, and it gives full response to PV changes. Otherwise controller action is as described for the PID A equation. See note on PID A.</p> <p>PD WITH MANUAL RESET—This is used whenever integral action is not wanted for automatic control action. The equation is computed with no integral contribution. The MANUAL RESET value, which is operator adjustable, is then added to the present output to form the controller output.</p> <p>Switching between manual and automatic mode is bumpless (output does not change value).</p> <p>If you select PD with Manual Reset you can also configure the following variations:</p> <ul style="list-style-type: none"> • PD (Two Mode) control, • P (Single Mode) control. <p>Set Rate (D) to 0.</p> <p>ATTENTION <i>Other prompts affected: MAN RSET in the Tuning Set Up group</i></p>

Function Prompt Lower Display	Selections or Range of Setting Upper Display	Parameter Definition
	3PSTEP	<p>THREE POSITION STEP—The Three Position Step Control algorithm allows the control of a valve (or other actuator) with an electric motor driven by two controller relay outputs; one to move the motor upscale, the other downscale without a feedback slidewire linked to the motor shaft. The deadband is adjustable in the same manner as the duplex output algorithm.</p> <p>The Three Position Step Control algorithm provides an output display (OUT), which is an estimated motor position, since the motor is not using any slidewire feedback. Although this output indication is only an approximation, it is “corrected” each time the controller drives the motor to one of its stops (0 % or 100 %). It avoids all the control problems associated with the feedback slidewire (wear, dirt, noise). When operating in this algorithm, the estimated OUT display is shown to the nearest percent (i.e., no decimal). This selection forces the Output Algorithm selection to “POSPROP”. See <i>Subsection 3.14</i>.</p> <p>Refer to the <i>Operation</i> section for motor position displays.</p> <p>As a customer configurable option, when a third input board is installed, the motor slidewire can be connected to the controller. The actual slidewire position is then shown on the lower display as POS. This value is used for display only. It is NOT used in the Three Position Step algorithm. To configure this option, set Input 3 actuation to SLIDEW and then calibrate Input 3 per <i>Subsection 6.5</i>.</p> <p>ATTENTION <i>Other prompts affected: DEADBAND</i></p>
PID LOOPS	<p>1 LOOP</p> <p>2 LOOPS</p> <p>CASCADE</p>	<p>PID LOOPS—Number of PID Loops to be used.</p> <p>1 LOOP—Select one loop of control.</p> <p>2 LOOPS—Select two independent loops of control, each with its own PID tuning sets and control parameters.</p> <p>CASCADE—Select Cascade Control. In a Cascade control system, the output of the primary loop (loop 2) is used to adjust the remote setpoint of the secondary loop (loop 1). The output of the secondary loop is used to control the final control element.</p>

Function Prompt Lower Display	Selections or Range of Setting Upper Display	Parameter Definition
CONT2ALG	PID A PID B PD+MR	<p>CONTROL ALGORITHM FOR LOOP 2—This prompt only appears if Two Loop or Cascade control has been selected.</p> <p>3PSTEP and ON-OFF control are not available on the Second Control Loop.</p> <p>PID A—Same as Loop 1. PID B—Same as Loop 1. PD WITH MANUAL RESET—Same as Loop 1.</p>
OUT OVRD	DISABLE HI SEL LO SEL	<p>OUTPUT OVERRIDE SELECT—This selection lets you select high or low output override. Only available if the controller is configured for Two Loop operation. Not applicable for Three Position Step applications.</p> <p>ATTENTION Loop 1 must be in Automatic for this selection to work. While the output is being overridden, a blinking “O” appears on the left of the upper display.</p> <p>DISABLE—Disables the override function.</p> <p>HIGH SELECT—The controller will select the higher of output 1 or output 2 and direct it to the rear terminals for output 1.</p> <p>LOW SELECT—The controller will select the lower of output 1 or output 2 and direct it to the rear terminals for output 1.</p>
TIMER	DISABLE ENABLE	<p>TIMER—Enable or disable the timer option.</p> <p>The timer option allows you to configure a timeout period and to select timer start by either the keyboard (via the Run/Hold key) or Alarm 2. A digital input can also be configured to start the timer.</p> <p>When the timer is enabled, it has exclusive control of the alarm 1 relay; any previous alarm configuration is ignored. At timeout, the timer is ready to be re-activated by whatever action has been configured. Alarm 1 is activated at the end of the timeout period.</p>
PERIOD	0:00 to 99:59	<p>PERIOD—The length of timeout period (either from 0 to 99 hours: 59 minutes or from 59 minutes: 59 seconds depending upon Period configuration).</p>
START	KEY ALARM 2	<p>START—Select whether the timer starts with the keyboard (via the Run/Hold key) or via Alarm 2.</p>

Function Prompt Lower Display	Selections or Range of Setting Upper Display	Parameter Definition
LWR DISP	TI REM EL TIME	<p>LOWER DISPLAY—Select whether time remaining (TI REM) or elapsed time (EL TIME) is displayed for the timer option.</p> <p>The time is shown on the lower display in HH:MM format along with a rotating “clock” character.</p> <ul style="list-style-type: none"> • If the “clock” rotation is <i>clockwise</i>, elapsed time is indicated. • If the “clock” rotation is <i>counterclockwise</i>, time remaining is indicated.
RESET	KEY ALARM 1	<p>TIMER RESET CONTROL—Select how the timer is reset.</p> <p>KEY - Timer reset with the Run/Hold key.</p> <p>ALARM 1 - Timer reset with either Alarm 1 or by the Run/Hold key</p>
INCRMENT	MINUTE SECOND	INCREMENT —Select the increments of the Period configuration.
<p>INPUT MATH ALGORITHMS—Controllers with at least two analog inputs are provided with two input algorithms. Each algorithm can be configured to provide a derived (calculated) PV or a derived Remote Setpoint. Up to three inputs may be used in each algorithm. In addition, the two algorithms may be “linked” so as to combine the calculations by configuring one algorithm to be an input to the other algorithm.</p> <p>All algorithms operate in Engineering Units except Feedforward, which operates in percent of range units.</p> <p>ATTENTION When the Input C configuration is set to NONE, the value of Input C used in the functions is automatically set to 1.0, except for the Summer algorithm, where it is set to 0.0.</p>		
INP ALG1	<p>NONE W AVG (See Note 2)</p> <p>(Standard feature on controllers with two or more analog inputs)</p> $\text{Alg1} = [(\text{Input A} \times \text{Ratio A} + \text{Bias A}) + (\text{K} \times \text{Input B} \times \text{Ratio B} + \text{Bias B})] / (1 + \text{K}) + \text{Alg1Bias}$	<p>INPUT ALGORITHM 1—Represents one of the following selections:</p> <p>NONE—No algorithm configured</p> <p>WEIGHTED AVERAGE—When you configure for Weighted Average, the controller will compute a PV or SP for the control algorithm from the following equation:</p>

Function Prompt Lower Display	Selections or Range of Setting Upper Display	Parameter Definition
	<p>F FWRD</p> <p>(Standard feature on controllers with two or more analog inputs)</p>	<p>FEEDFORWARD SUMMER—Feedforward uses Input A, following a Ratio and Bias calculation, as a value summed directly with the PID computed output value and sent, as an output value, to the final control element.</p> <p>This algorithm will only function in automatic mode and is not used for Three Position Step Control applications. Algorithm 1 Feedforward works only on Loop 1 while Algorithm 2 Feedforward works only on Loop 2.</p> <p>The following formula applies:</p> $\text{Controller Output} = \text{PID Output} + (\text{Input A} \times \text{Ratio A} + \text{Bias A}) \times (100 / \text{Input A Range})$
	<p>FFWDMu</p> <p>(Standard feature on controllers with two or more analog inputs)</p>	<p>FEEDFORWARD MULTIPLIER—Feedforward uses Input A, following a Ratio and Bias calculation, as a value multiplied directly with the PID computed output value and sent, as an output value, to the final control element.</p> <p>This algorithm will only function in automatic mode and cannot be used for Three Position Step Control applications. Algorithm 1 Feedforward works only on Loop 1 while Algorithm 2 Feedforward works only on Loop 2.</p> <p>The following formula applies:</p> $\text{Controller Output} = \text{PID Output} \times (\text{Input A} \times \text{Ratio A} + \text{Bias A}) / \text{Input A Range}$
	<p>RELHUM</p> <p>(Standard feature on controllers with two or more analog inputs)</p>	<p>RELATIVE HUMIDITY—Input 1 reads the wet bulb temperature. Input 2 reads the dry bulb temperature. The controller will indicate measured Relative Humidity as a Process Variable (PV) with a Setpoint range of 0 % to 100 % RH.</p> <p>ATTENTION The Relative Humidity selection will automatically force both Input 1 and Input 2 actuators to the RTD 100 ohm low setting. See Note 6.</p>
	<p>SUMMER (See Note 2)</p>	<p>SUMMER WITH RATIO AND BIAS—The following formula applies:</p> $\text{Alg1} = (\text{Input A} \times \text{Ratio A} + \text{Bias A}) + (\text{Input B} \times \text{Ratio B} + \text{Bias B}) + (\text{Input C} \times \text{Ratio C} + \text{Bias C}) + \text{Alg1Bias}$
	<p>HI SEL (See Note 2)</p>	<p>INPUT HIGH SELECT WITH RATIO AND BIAS—This selection specifies the PV or SP as the higher of Input A or Input B. The following formula applies:</p> $\text{Alg1} = \text{higher of } (\text{Input A} \times \text{Ratio A} + \text{Bias A}) \text{ or } (\text{Input B} \times \text{Ratio B} + \text{Bias B})$

Function Prompt Lower Display	Selections or Range of Setting Upper Display	Parameter Definition
	LO SEL (See Note 2)	INPUT LOW SELECT WITH RATIO AND BIAS — This selection specifies the PV or SP as the lower of Input A or Input B. The following formula applies: $\text{Alg1} = \text{lower of } (\text{Input A} \times \text{Ratio A} + \text{Bias A}) \text{ or } (\text{Input B} \times \text{Ratio B} + \text{Bias B})$
	$\sqrt{\text{MuDIV}}$ (See Note 1)	MULTIPLIER DIVIDER WITH SQUARE ROOT — The following formula applies: $\text{Alg1} = K \times \text{Sq.Rt.} \{ (\text{Input A} \times \text{Ratio A} + \text{Bias A}) \times (\text{Input C} \times \text{Ratio C} + \text{Bias C}) / (\text{Input B} \times \text{Ratio B} + \text{Bias B}) \}$ $\times (\text{Calc Hi} - \text{Calc Lo}) + \text{Alg1Bias}$ See Figure 3-1 at the end of this section for an example of Mass Flow Compensation using the Multiplier/Divider Algorithm.
	$\sqrt{\text{MULT}}$ (See Note 1)	MULTIPLIER WITH SQUARE ROOT —The following formula applies: $\text{Alg1} = K \times \text{Sq.Rt.} \{ (\text{Input A} \times \text{Ratio A} + \text{Bias A}) \times (\text{Input B} \times \text{Ratio B} + \text{Bias B}) \times (\text{Input C} \times \text{Ratio C} + \text{Bias C}) \}$ $\times (\text{Calc Hi} - \text{Calc Lo}) + \text{Alg1Bias}$
	MuDIV (See Note 1)	MULTIPLIER DIVIDER —The following formula applies: $\text{Alg1} = K \times \{ (\text{Input A} \times \text{Ratio A} + \text{Bias A}) \times (\text{Input C} \times \text{Ratio C} + \text{Bias C}) / (\text{Input B} \times \text{Ratio B} + \text{Bias B}) \}$ $\times (\text{Calc Hi} - \text{Calc Lo}) + \text{Alg1Bias}$
	MULT (See Note 1)	MULTIPLIER —The following formula applies: $\text{Alg1} = K \times [(\text{Input A} \times \text{Ratio A} + \text{Bias A}) \times (\text{Input C} \times \text{Ratio C} + \text{Bias C}) \times (\text{Input B} \times \text{Ratio B} + \text{Bias B})]$ $\times (\text{Calc Hi} - \text{Calc Lo}) + \text{Alg1Bias}$
	CARB A	CARBON POTENTIAL A —Make this selection if you have a Cambridge or Marathon monitor type Zirconium Oxide sensor. It should also be used if using an Automotive probe (no thermocouple). This algorithm requires a temperature range within the region of 1500 to 2000°F. See Carbon/Oxygen/Dewpoint Notes.
	CARB B	CARBON POTENTIAL B —Make this selection if you have a Corning type Zirconium Oxide sensor. This algorithm requires a temperature range within the region of 1500 to 1800°F. See Carbon/Oxygen/Dewpoint Notes.
	CARB C	CARBON POTENTIAL C —Make this selection if you have an A.A.C.C. type Zirconium Oxide sensor. This algorithm requires a temperature range within the region of 1500 to 1900°F. See Carbon/Oxygen/Dewpoint Notes.

Function Prompt Lower Display	Selections or Range of Setting Upper Display	Parameter Definition
	CARB D	CARBON POTENTIAL D —Make this selection if you have a Barber Coleman, MacDhui, or Brisco type Zirconium Oxide sensor. This algorithm requires a temperature range within the region of 800 to 1100°C. See Carbon/Oxygen/Dewpoint Notes.
	FCC	CARBON POTENTIAL FCC —Make this selection if you have a Furnace Controls Corp Accucarb type Zirconium Oxide sensor. This algorithm requires a temperature range within the region of 1500 °F to 1900°F. See Carbon/Oxygen/Dewpoint Notes.
	DEW PT	DEWPOINT OF CARBONIZING ATMOSPHERE —Use this selection if you are using any Zirconium Oxide Carbon Probe and you want to measure the atmosphere in terms of Dewpoint. The range is –50 °F to 100 °F or –48 °C to 38 °C. This algorithm requires a temperature range within the region of 1000 °F to 2200 °F and a minimum carbon probe value of 800 millivolts. See Carbon/Oxygen/Dewpoint Notes.
	OXYGEN	PERCENT OXYGEN RANGE —Make this selection if you are using a Zirconium Oxide Oxygen Probe to measure Percent of Oxygen in a range of 0 to 40 % O ₂ . This algorithm requires a temperature range within the region of 800 °F to 3000 °F. See Carbon/Oxygen/Dewpoint Notes.

ATTENTION Carbon/Oxygen/Dewpoint Notes

- The Carbon and Dewpoint selections will automatically set Input 1 actuation to CARBON. The Oxygen selection will automatically set Input 1 actuation to OXYGEN.
- Input 2 can be any input actuation, but it is normally a type K, R or S thermocouple input, depending upon the probe type selected.
- All calculations are performed by the Controller, with Percent Carbon, Percent Oxygen or Dewpoint shown as the PV display. The actual value of each analog input may be viewed via the lower display.
- For all Carbon Types, if the value of Percent Carbon falls below 0.1% - such as can happen when the Carbon Probe voltage output falls below 900 mVdc – then the Controller will continue to update the PV display, but the accuracy is unspecified. Likewise, if the measured temperature falls outside of the specified ranges as noted above for the Carbon, Oxygen and Dewpoint input types, then the Controller will continue to update the PV display, but the accuracy is unspecified.
- For the Dewpoint algorithm, if the Carbon Sensor voltage falls below 800 mVdc, then the Dewpoint is calculated as if the sensor voltage was at 800 mVdc.
- If the Ratio for Input 2 is set to 0.0, then a constant value may be used for the Input 2 value via the Input 2 Bias setting. When Input 2 Ratio is set to 0.0, the Input 2 low range and Sooting diagnostic messages are disabled.

Function Prompt Lower Display	Selections or Range of Setting Upper Display	Parameter Definition
MATH K	0.001 to 1000 floating	WEIGHTED AVERAGE RATIO OR MASS FLOW ORIFICE CONSTANT (K) FOR MATH SELECTIONS —Only applicable for algorithms W AVG or General Math selections $\sqrt{\text{MuDIV}}$, $\sqrt{\text{MULT}}$, MuDIV, or MULT.
CALC HI	–999. To 9999. Floating (in engineering units)	CALCULATED VARIABLE HIGH SCALING FACTOR FOR INPUT ALGORITHM 1 —Used only when Summer, Input Hi/Lo, or one of the General Math functions was selected as the Input Algorithm. See Note 2.
CALC LO	–999. To 9999. Floating (in engineering units)	CALCULATED VARIABLE LOW SCALING FACTOR FOR INPUT ALGORITHM 1 —Used only when Summer, Input Hi/Lo, or one of the General Math functions was selected as the Input Algorithm. See Note 2.
ALG1 INA	INPUT 1 INPUT 2 INPUT 3 INPUT 4 INPUT 5 LP1OUT LP2OUT IN AL1 IN AL2	ALGORITHM 1, INPUT A SELECTION —Represents one of the following selections: INPUT 1 INPUT 2 INPUT 3 INPUT 4 INPUT 5 LOOP 1 OUTPUT —Should not be used for Three Position Step Control applications LOOP 2 OUTPUT —Should not be used for Three Position Step Control applications INPUT ALGORITHM 1 INPUT ALGORITHM 2
ALG1 INB	INPUT 1 INPUT 2 INPUT 3 INPUT 4 INPUT 5 LP1OUT LP2OUT IN AL1 IN AL2	ALGORITHM 1, INPUT B SELECTION —Represents one of the following selections: INPUT 1 INPUT 2 INPUT 3 INPUT 4 INPUT 5 LOOP 1 OUTPUT —Should not be used for Three Position Step Control applications LOOP 2 OUTPUT —Should not be used for Three Position Step Control applications INPUT ALGORITHM 1 INPUT ALGORITHM 2

Function Prompt Lower Display	Selections or Range of Setting Upper Display	Parameter Definition
ALG1 INC	NONE INPUT 1 INPUT 2 INPUT 3 INPUT 4 INPUT 5 LP1OUT LP2OUT IN AL1 IN AL2	ALGORITHM 1, INPUT C SELECTION — Represents one of the following selections: NONE INPUT 1 INPUT 2 INPUT 3 INPUT 4 INPUT 5 LOOP 1 OUTPUT —Should not be used for Three Position Step Control applications LOOP 2 OUTPUT —Should not be used for Three Position Step Control applications INPUT ALGORITHM 1 INPUT ALGORITHM 2
PCO SEL	MANUAL INPUT 3	SOURCE OF PERCENT CARBON MONOXIDE — Select either a fixed value for %CO value (PCT CO) or use a live value from Analog Input 3. MANUAL —Operator enters %CO as a Fixed Value per the PCT CO configuration. INPUT 3 —Input 3 is used to provide the %CO value to the Carbon Potential algorithm. ATTENTION This prompt only appears when one of the Carbon Potential algorithms is selected and Input 3 is one of the following types: 0-20 mA, 4-20 mA, 0-5 V or 1-5 V.
PCT CO	0.020 to 0.350 (fractional percent of CO)	PERCENT CARBON MONOXIDE —Used only when a Carbon Potential algorithm is selected and PCO SEL is set to MANUAL. Enter a value in percent of carbon monoxide that is applicable for the enriching gas used in fractional form. FOR EXAMPLE: Natural Gas = 20.0 % CO, then setting is 0.200 Propane Gas = 23.0 % CO, setting is 0.230 ATTENTION This prompt appears only when one of the Carbon Potential algorithms is selected.
PCT H2	1.0 to 99.0 (% H ₂)	HYDROGEN CONTENT FOR DEWPOINT —Used only when Dewpoint is selected. Enter a value for the percentage of Hydrogen content that is applicable.
ATM PRES	590.0 to 760.0 (mm Hg)	ATMOSPHERIC PRESSURE COMPENSATION — Used only when Relative Humidity is selected. Enter the value of the atmospheric pressure of the process.

Function Prompt Lower Display	Selections or Range of Setting Upper Display	Parameter Definition
ALG1BIAS	-999 to 9999 floating (in engineering units)	INPUT ALGORITHM 1 BIAS —Does not apply to selections: FFWRD, FFWDMU, HISEL or LOSEL.
<p>ATTENTION</p> <ul style="list-style-type: none"> • All Input Algorithms operate in engineering units except Feed-forward which operates in percent of range units. • For General Math functions, when Input C is disabled, the value of Input C used in the functions is automatically set to 1.0. 		
INP ALG2	NONE W AVG F FWR2 FFWDM2 A-B/C HI SEL LO SEL √MuDIV √MULT MuDIV MULT DEW PT	<p>INPUT ALGORITHM 2—The formulas for these selections are the same as those for IN ALG 1 with the following exceptions: Relative Humidity, all Carbon Potential and Oxygen algorithms are not available. Feedforward works only on Loop 2.</p> <p>ATTENTION Selection A–B/C algorithm is used in place of IN ALG1 A+B+C algorithm. The A-B/C algorithm subtracts Input B with Ratio/Bias from Input A with Ratio/Bias and divides the result by Input C with Ratio/Bias using engineering units. This selection is only available on Input Algorithm 2.</p> <p>EXAMPLE:</p> $PV \text{ or } SP = K \frac{(A-B)}{C} (\text{Calc Hi} - \text{Calc Lo})$
MATH K2	0.001 to 1000 floating	WEIGHTED AVERAGE RATIO OR MASS FLOW ORIFICE CONSTANT (K) FOR MATH SELECTIONS —Only applicable for algorithm W AVG or General Math selections MuDIV, MULT, MuDIV, or MULT.
CALC HI	–999. To 9999. Floating (in engineering units)	CALCULATED VARIABLE HIGH SCALING FACTOR FOR INPUT ALGORITHM 2 —Does not apply to Feedforward algorithms. Range is used for either PV or RSP, depending upon Algorithm application.
CALC LO	–999. To 9999. Floating (in engineering units)	CALCULATED VARIABLE LOW SCALING FACTOR FOR INPUT ALGORITHM 2 —Does not apply to Feedforward algorithms. Range is used for either PV or RSP, depending upon Algorithm application.

Function Prompt Lower Display	Selections or Range of Setting Upper Display	Parameter Definition
ALG2 INA	INPUT 1 INPUT 2 INPUT 3 INPUT 4 INPUT 5 LP1OUT LP2OUT IN AL1 IN AL2	ALGORITHM 2, INPUT A SELECTION— Represents one of the following selections: INPUT 1 INPUT 2 INPUT 3 INPUT 4 INPUT 5 LOOP 1 OUTPUT— Should not be used for Three Position Step Control applications LOOP 2 OUTPUT— Should not be used for Three Position Step Control applications INPUT ALGORITHM 1 INPUT ALGORITHM 2
ALG2 INB	INPUT 1 INPUT 2 INPUT 3 INPUT 4 INPUT 5 LP1OUT LP2OUT IN AL1 IN AL2	ALGORITHM 2, INPUT B SELECTION— Represents one of the following selections: INPUT 1 INPUT 2 INPUT 3 INPUT 4 INPUT 5 LOOP 1 OUTPUT— Should not be used for Three Position Step Control applications LOOP 2 OUTPUT— Should not be used for Three Position Step Control applications INPUT ALGORITHM 1 INPUT ALGORITHM 2
ALG2 INC	NONE INPUT 1 INPUT 2 INPUT 3 INPUT 4 INPUT 5 LP1OUT LP2OUT IN AL1 IN AL2	ALGORITHM 2, INPUT C SELECTION— Represents one of the following selections: NONE INPUT 1 INPUT 2 INPUT 3 INPUT 4 INPUT 5 LOOP 1 OUTPUT— Should not be used for Three Position Step Control applications LOOP 2 OUTPUT— Should not be used for Three Position Step Control applications INPUT ALGORITHM 1 INPUT ALGORITHM 2
ALG2BIAS	-999 to 9999 floating (in engineering units)	INPUT ALGORITHM 2 BIAS— Does not apply to selections: FFWR2, FFWM2, HI SEL or LO SEL.

Function Prompt Lower Display	Selections or Range of Setting Upper Display	Parameter Definition
<p>Math Algorithm Notes:</p> <ol style="list-style-type: none"> 1. Calculation ranges for the Math Algorithms are set via CALC HI and CALC LO parameters and are between -999. and 9999. The SP High and Low values (SP Range) are independent of these settings and can be any value between -999. and 9999. 2. The CALC HI and CALC LO values determine the range limits for the SP High and Low values for the Weighted Average, Summer, Hi Select and Low Select algorithms. 3. Does not apply to Three Position Step Control. 4. If the calculated value of the quantity under the square root sign decreases to a value less than 0.010, then the calculation will become linear as the calculated value decreases below 0.010. 5. Input 2 is always used in all of the Feedforward algorithms. 6. When Relative Humidity is selected as the Input Algorithm, both Input 1 (Wet Bulb) and Input 2 (Dry Bulb) are forced to the RTD 100 Ohm Low activation. This activation normally has a range of a -300 to 300°F (-184 to 149°C). However, for Relative Humidity, the range of both inputs is restricted such that the Input measurements below 21°F or above 212°F (-6 °C or 100°C) for either input will result in an Input Range diagnostic message being shown on the lower display. This is because input values outside of this range will not calculate valid %RH values. If the calculated %RH value falls below zero, the "RH LOW" diagnostic message will appear on the lower display. 		

Figure 3-1 Mass Flow Example

Example - Mass Flow Compensation

A gas flow rate of 650 SCFM develops a differential pressure of 90" H₂O across an orifice plate at reference conditions of 30 psig and 140°F. Compensate this gas flow for temperature and pressure variations.

$$\text{Flow} = K \sqrt{\frac{DP_f \times P_f}{T_f} \times \frac{T_{ref}}{P_{ref}}}$$

Where:

f = flowing conditions
 ref = reference conditions (in absolute units)

Apply Multiplier/Divider Algorithm:

$$PV = K \sqrt{\frac{(\text{Input A} \times \text{Ratio A} + \text{Bias A}) \times (\text{Input C} \times \text{Ratio C} + \text{Bias C})}{(\text{Input B} \times \text{Ratio B} + \text{Bias B})}} \times (\text{Calc HI} - \text{Calc LO})$$

Assign inputs using Engineering units:

Let:

- Input A = DP_f = IN1 (in H₂O)
 - Input B = T_f = IN2 + Bias2 = IN2°F + 460 (°R)
 - Input C = P_f = IN3 + Bias3 = IN3psig + 14.7(psia)
 - T_{ref} = 140°F + 460 = 600°R
 - P_{ref} = 30 psig + 14.7 = 44.7 psia
 - Calc_{Hi} = 650.0
 - Calc_{Lo} = 0.0
- } Flow in SCFM at Reference Conditions
- K = to be determined next

Note: If temperature and pressure signals are already ranged in absolute units, no Bias is required for inputs B and C.

$$PV = Q_{SCFM} = \sqrt{\frac{DP_f \times (IN3 + 14.7)}{(IN2 + 460)}} \times K^2 \times (650.0 - 0.0)$$

Note: When IN2 and IN3 are at the reference conditions of 600°R (140°F) and 44.7psia (30 psig) respectively and DP_f = 90" H₂O, the equation must calculate 650 SCFM. To accomplish this, divide the DP value by "90" to normalize the equation.

$$Q_{SCFM} = \sqrt{\frac{DP_f}{90} \times \frac{(IN3 + 14.7)}{(IN2 + 460)}} \times \frac{T_{ref}}{P_{ref}} \times 650$$

Rearranging terms:

$$Q_{SCFM} = \sqrt{DP_f \times \frac{(IN3 + 14.7)}{(IN2 + 460)}} \times \frac{1}{90} \times \frac{T_{ref}}{P_{ref}} \times 650$$

↓ Variable ↓ Constant = K²

Example continued on next page

22049

Example - Mass Flow Compensation - continued

Determined value of K:

$$K^2 = \frac{1}{90} \times \frac{T_{ref}}{P_{ref}} = \frac{600}{(90)(44.7)} = 0.14914$$

Therefore K = 0.386

$$Q_{SCFM} = (0.386) (650) \sqrt{\frac{DP_f \text{ (in H}_2\text{O)} \text{ (IN3 + 14.7)}}{(IN2 + 460)}}$$

K (Calc_{HI} - Calc_{LO})

Summary of Flow Values At Values Conditions

	Temp (T _f) (°R)	Pressure (T _f) (psia)	Flow (SCFM)	
			DP _f = 45" H ₂ O (50%)	DP _f = 90" H ₂ O (100%)
Reference Conditions	140°F + 460	30 psi + 14.7	459	650
	170°F + 460	50 psi + 14.7	539	763
	170°F + 460	20 psi + 14.7	395	559
	110°F + 460	50 psi + 14.7	567	802
	110°F + 460	20 psi + 14.7	415	587

22050

3.12 Math Set Up Group

Introduction

These selections are provided only as part of the Math Options package.

ATTENTION

Enabling SP Program 4 automatically disables the characterizers in the Math Setup Group.

Function Prompts

Table 3-12 MATH Group Function Prompts

Function Prompt Lower Display	Selections or Range of Setting Upper Display	Parameter Definition
<p>8SEG CH1</p>	<p>DISABLE INPUT1 INPUT2 INPUT3 INPUT4 INPUT5 L1 OUT L2 OUT</p>	<p>8 SEGMENT CHARACTERIZER #1—An eight-segment characterizer can be applied to any analog input, Output 1 or Output 2.</p> <p>DISABLE—Disables characterizer.</p> <p>INPUT 1—Characterizer is applied to Input 1.</p> <p>INPUT 2—Characterizer is applied to Input 2.</p> <p>INPUT 3—Characterizer is applied to Input 3.</p> <p>INPUT 4—Characterizer is applied to Input 4.</p> <p>INPUT 5—Characterizer is applied to Input 5.</p> <p>LOOP 1 OUTPUT—Characterizer is applied to Loop 1 Output. – Should not be used for Three Position Step Control or Position Proportional Control applications</p> <p>LOOP 2 OUTPUT—Characterizer is applied to Loop 2 Output.</p> <p>There are eight (Xn) Input values and eight (Yn) Output values to be selected. The following rules apply:</p> <ul style="list-style-type: none"> • When any analog input is used, the Input Ratio and Bias for that input are applied to the Xn Values. • When one of the Loop outputs are selected, the Xn Input values are the Output from the control algorithm, and the Yn Output is the final control element action. This application is useful for non-linear control elements or Process Variable. <p>A simple example is shown in Figure 3-2.</p>

Function Prompt Lower Display	Selections or Range of Setting Upper Display	Parameter Definition
ATTENTION <i>The X values below should be entered as increasing values (from 0% to 99.99%) from N = 0 to 8.</i>		
X0 VALUE	0.00 to 99.99 %	X0 INPUT VALUE (X AXIS)
X1 VALUE	0.00 to 99.99 %	X1 INPUT VALUE (X AXIS)
X2 VALUE	0.00 to 99.99 %	X2 INPUT VALUE (X AXIS)
X3 VALUE	0.00 to 99.99 %	X3 INPUT VALUE (X AXIS)
X4 VALUE	0.00 to 99.99 %	X4 INPUT VALUE (X AXIS)
X5 VALUE	0.00 to 99.99 %	X5 INPUT VALUE (X AXIS)
X6 VALUE	0.00 to 99.99 %	X6 INPUT VALUE (X AXIS)
X7 VALUE	0.00 to 99.99 %	X7 INPUT VALUE (X AXIS)
X8 VALUE	0.00 to 99.99 %	X8 INPUT VALUE (X AXIS)
Y0 VALUE	0.00 to 99.99 %	Y0 INPUT VALUE (Y AXIS)
Y1 VALUE	0.00 to 99.99 %	Y1 INPUT VALUE (Y AXIS)
Y2 VALUE	0.00 to 99.99 %	Y2 INPUT VALUE (Y AXIS)
Y3 VALUE	0.00 to 99.99 %	Y3 INPUT VALUE (Y AXIS)
Y4 VALUE	0.00 to 99.99 %	Y4 INPUT VALUE (Y AXIS)
Y5 VALUE	0.00 to 99.99 %	Y5 INPUT VALUE (Y AXIS)
Y6 VALUE	0.00 to 99.99 %	Y6 INPUT VALUE (Y AXIS)
Y7 VALUE	0.00 to 99.99 %	Y7 INPUT VALUE (Y AXIS)
Y8 VALUE	0.00 to 99.99 %	Y8 INPUT VALUE (Y AXIS)

Function Prompt Lower Display	Selections or Range of Setting Upper Display	Parameter Definition
<p>8SEG CH2</p>	<p>DISABLE INPUT1 INPUT2 INPUT3 INPUT4 INPUT5 L1 OUT L2 OUT LINK</p>	<p>8 SEGMENT CHARACTERIZER #2—An eight-segment characterizer can be applied to any analog input, Output 1 or Output 2. When Characterizer # 2 is set to LINK, then a single sixteen-segment characterizer is formed.</p> <p>DISABLE—Disables characterizer.</p> <p>INPUT 1—Characterizer is applied to Input 1.</p> <p>INPUT 2—Characterizer is applied to Input 2.</p> <p>INPUT 3—Characterizer is applied to Input 3.</p> <p>INPUT 4—Characterizer is applied to Input 4.</p> <p>INPUT 5—Characterizer is applied to Input 5.</p> <p>LOOP 1 OUTPUT—Characterizer is applied to Loop 1 Output. – Should not be used for Three Position Step Control or Positional Proportional Control applications.</p> <p>LOOP 2 OUTPUT—Characterizer is applied to Loop 2 Output.</p> <p>There are eight (Xn) Input values and eight (Yn) Output values to be selected. The following rules apply:</p> <ul style="list-style-type: none"> • When any analog input is used, the Input Ratio and Bias for that input are applied to the Xn Values. • When one of the Loop outputs are selected, the Xn Input values are the Output from the control algorithm, and the Yn Output is the final control element action. This application is useful for non-linear control elements or Process Variable. <p>LINK—Concatenate the two 8 segment characterizers into a single 16-segment characterizer. Application of the characterizer is then selected by the Characterizer #1 configuration.</p>

ATTENTION *The X values below should be entered as increasing values (from 0% to 99.99%) from N=9 to 17.*

X9 VALUE	0.00 to 99.99 %	X9 INPUT VALUE (X AXIS)
X10VALUE	0.00 to 99.99 %	X10 INPUT VALUE (X AXIS)
X11VALUE	0.00 to 99.99 %	X11 INPUT VALUE (X AXIS)
X12VALUE	0.00 to 99.99 %	X12 INPUT VALUE (X AXIS)
X13VALUE	0.00 to 99.99 %	X13 INPUT VALUE (X AXIS)
X14VALUE	0.00 to 99.99 %	X14 INPUT VALUE (X AXIS)
X15VALUE	0.00 to 99.99 %	X15 INPUT VALUE (X AXIS)
X16VALUE	0.00 to 99.99 %	X16 INPUT VALUE (X AXIS)
X17VALUE	0.00 to 99.99 %	X17 INPUT VALUE (X AXIS)

Function Prompt Lower Display	Selections or Range of Setting Upper Display	Parameter Definition
Y9 VALUE	0.00 to 99.99 %	Y9 INPUT VALUE (Y AXIS)
Y10VALUE	0.00 to 99.99 %	Y10 INPUT VALUE (Y AXIS)
Y11VALUE	0.00 to 99.99 %	Y11 INPUT VALUE (Y AXIS)
Y12VALUE	0.00 to 99.99 %	Y12 INPUT VALUE (Y AXIS)
Y13VALUE	0.00 to 99.99 %	Y13 INPUT VALUE (Y AXIS)
Y14VALUE	0.00 to 99.99 %	Y14 INPUT VALUE (Y AXIS)
Y15VALUE	0.00 to 99.99 %	Y15 INPUT VALUE (Y AXIS)
Y16VALUE	0.00 to 99.99 %	Y16 INPUT VALUE (Y AXIS)
Y17VALUE	0.00 to 99.99 %	Y17 INPUT VALUE (Y AXIS)
TOTALIZE	DISABLE INPUT 1 INPUT 2 INPUT 3 INPUT 4 INPUT 5 IN AL1 IN AL2	<p>TOTALIZER FUNCTION calculates and displays the total flow volume as measured by any analog input or applied to either Input Algorithm 1 or Input Algorithm 2 to totalize the compensated flow rate being calculated by the algorithm. Displayed value is eight digits with a configurable scale factor.</p> <p>DISABLE—Disables the totalizer function. INPUT 1—Input 1 is Totalized. INPUT 2—Input 2 is Totalized. INPUT 3—Input 3 is Totalized. INPUT 3—Input 4 is Totalized. INPUT 5—Input 5 is Totalized. IN ALG1—Input Algorithm 1 is Totalized. IN ALG2—Input Algorithm 2 is Totalized.</p> <p>ATTENTION The totalizer should always be reset to initialize the counters whenever it is enabled.</p>
ΣXXXXXXX	Σ*En	<p>TOTALIZER VALUE—READ ONLY Current Scale Factor (Upper Display) Actual Current Totalized Value (Lower Display)</p>
TOT SCAL	<p>E0 = 1 x 10⁰ = 1 E1 = 1 x 10¹ = 10 E2 = 1 x 10² = 100 E3 = 1 x 10³ = 1,000 E4 = 1 x 10⁴ = 10,000 E5 = 1 x 10⁵ = 100,000 E6 = 1 x 10⁶ = 1,000,000</p>	<p>TOTALIZER SCALE FACTOR—Selects the desired Scale Factor (i.e., Multiplier). The desired factor is applied to the calculated value to extend the maximum flow range that can be displayed.</p>
TOT SCR	UNLOCK LOCK	<p>TOTALIZER RESET SECURITY LOCK—Allows the totalizer to be reset.</p> <p>UNLOCK—Allows the totalizer value to be reset. LOCK—Prevents the totalizer value from being reset.</p>

Function Prompt Lower Display	Selections or Range of Setting Upper Display	Parameter Definition
Σ RESET?	NO YES	<p>TOTALIZER RESET—This prompt appears only if the totalizer is unlocked.</p> <p>NO—No Reset YES—Resets the Totalizer value on next  key press.</p>
TOT RATE	SECOND MINUTE HOUR DAY MIL/DAY	<p>TOTALIZER INTEGRATION RATE—Determines the rate at which the Totalizer is updated.</p> <p>SECOND—Engineering units per second MINUTE—Engineering units per minute HOUR—Engineering units per hour DAY—Engineering units per day MIL/DAY—Millions of units per day</p> <p>ATTENTION The source of the Totalizer is averaged over the sample and update rates. For example, as the loop cycle speed is six per second, then with the Totalizer Rate set at once per minute, the source is averaged six times per second and the Totalizer value is updated with this average value ÷ 60 once per second.</p>
POLYNOM	DISABLE INPUT 1 INPUT 2 INPUT 3 INPUT 4 INPUT 5 $Y = C_0 + C_1 X + C_2 * 10^{-1} X^2 + C_3 * 10^{-3} X^3 + C_4 * 10^{-5} X^4 + C_5 * 10^{-7} X^5$	<p>POLYNOMIAL EQUATION—A fifth order Polynomial Equation can be used on any one of the five Analog Inputs.</p> <p>The equation is in the form:</p> <p>Where: X is the value of the input in % of span C₀ is a value between -99.99 to +99.99 C₁ – C₅ are values between -9.999 to +9.999</p> <p>Ratio and Bias can be applied on the “Y” output term as follows: Calculated “Y” Value = Y * Input X Ratio + Input X Bias</p> <p>After the Polynomial is enabled, refer to the prompts listed below and enter the coefficients.</p>
C0 VALUE	-99.99 to 99.99	POLYNOMIAL COEFFICIENT C0
C1 VALUE	-9.999 to 9.999	POLYNOMIAL COEFFICIENT C1
C2 X 10⁻¹	-9.999 to 9.999	POLYNOMIAL COEFFICIENT C2
C3 X 10⁻³	-9.999 to 9.999	POLYNOMIAL COEFFICIENT C3
C4 X 10⁻⁵	-9.999 to 9.999	POLYNOMIAL COEFFICIENT C4
C5 X 10⁻⁷	-9.999 to 9.999	POLYNOMIAL COEFFICIENT C5

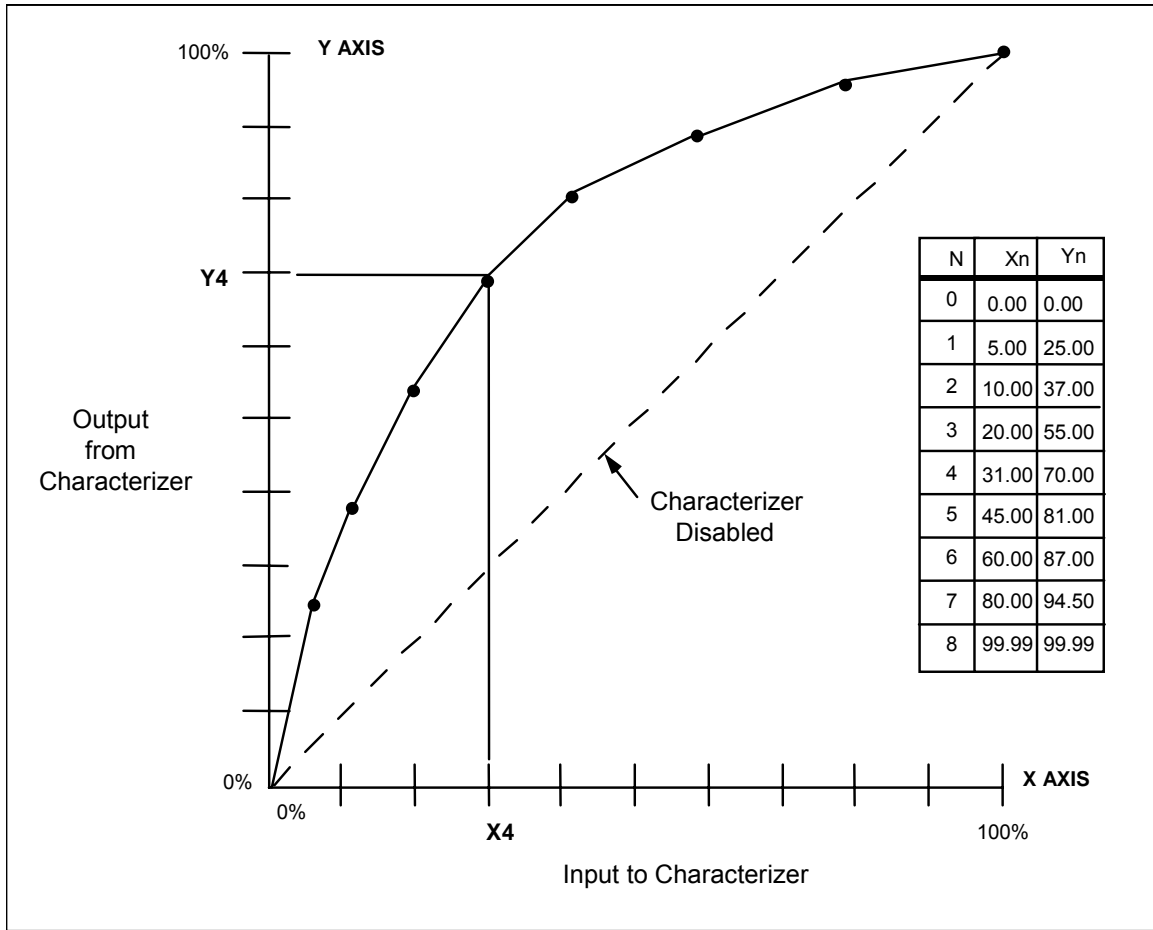

Figure 3-2 Example of Eight Segment Characterizer

3.13 Logic Gates Set Up Group

Introduction

This Set Up Group is provided only as part of the Math Options package.

This group deals with various Logic Gates that are available for use in the controller. Up to five different gates can be configured.

ATTENTION

If the controller is configured to use the same relay for more than one function, then the following priority is used to determine how the relay functions: Control Outputs take precedence over Alarms, which in turn take precedence over Time/Events, which in turn take precedence over Logic Gate Outputs. For example, if you select the Loop 2 Output Algorithm as Time Simplex (which uses Relay 3), enable Alarm 3 (which also uses Relay 3) and configure a Logic Gate to use Relay 3, then the instrument will use Relay #3 to perform the Time Simplex output and ignore the Alarm and Logic Gate functions.

Logic Gates are processed in numerical order. For example, if Logic Gate 2 and Logic Gate 4 are configured in a contradictory manner, then Logic Gate 2 will take precedence and Logic Gate 4 will be ignored.

Logic Gate Outputs configured for Relays will light an annunciator when active. Outputs for Relay 1 through Relay 4 will light annunciators OUT 1 through 4. Logic Gate Outputs for Relay 5 will light annunciator ALM 1.

Function Prompts

Table 3-13 LOGIC Group Function Prompts

Function Prompt Lower Display	Selections or Range of Setting Upper Display	Parameter Definition								
LOG GATE	DISABLE ENABLE	<p>LOGIC GATES—This feature is available only with controllers that have the math option.</p> <p>DISABLE—Disables Logic Gates Functions. ENABLE—Enables Logic Gates Function.</p> <p>ATTENTION For each Logic Gate, make a selection for:</p> <table style="margin-left: auto; margin-right: auto;"> <tr> <td style="padding-right: 20px;">Gate Type</td> <td>GATEnTYP</td> </tr> <tr> <td>Input A Source</td> <td>GATEnINA</td> </tr> <tr> <td>Input B Source</td> <td>GATEnINB</td> </tr> <tr> <td>Output Use</td> <td>GATEnOUT</td> </tr> </table> <p style="text-align: center;">where n = 1, 2, 3, 4 or 5</p>	Gate Type	GATEnTYP	Input A Source	GATEnINA	Input B Source	GATEnINB	Output Use	GATEnOUT
Gate Type	GATEnTYP									
Input A Source	GATEnINA									
Input B Source	GATEnINB									
Output Use	GATEnOUT									

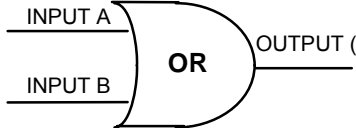
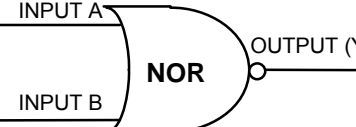
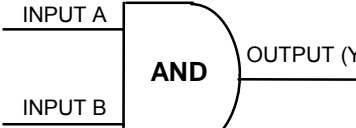
Function Prompt Lower Display	Selections or Range of Setting Upper Display	Parameter Definition																																													
<p>GATE(n)TYP (n = 1, 2, 3, 4, or 5)</p>	<p>NOT USED</p> <p>OR</p> <p>NOR</p> <p>AND</p>	<p>GATE TYPE—In digital logic, there are only two states that can be present: “0” – OFF or “1” – ON</p> <p>Listed are definitions of the gates available and their truth table which indicate what happens to the Output with regard to the state of the Inputs.</p> <p>NOT USED—No Selection</p> <p>OR—With this gate, if Input A OR Input B is ON, then the Output will be ON. Also, if both Inputs are ON, the Output will also be ON because it takes any one Input being <u>ON</u> to make the Output</p> <div style="display: flex; align-items: center; justify-content: center;">  <table border="1" style="margin-left: 20px;"> <thead> <tr> <th>A</th> <th>B</th> <th>Y</th> </tr> </thead> <tbody> <tr> <td>0</td> <td>0</td> <td>0</td> </tr> <tr> <td>0</td> <td>1</td> <td>1</td> </tr> <tr> <td>1</td> <td>0</td> <td>1</td> </tr> <tr> <td>1</td> <td>1</td> <td>1</td> </tr> </tbody> </table> </div> <p>NOR—The NOR gate is similar to the OR gate, except that the Output is inverted. It is exactly opposite of the OR gate and is referred to as NOT OR or NOR. If Input A or Input B are <u>ON</u>, the Output is <u>OFF</u>.</p> <div style="display: flex; align-items: center; justify-content: center;">  <table border="1" style="margin-left: 20px;"> <thead> <tr> <th>A</th> <th>B</th> <th>Y</th> </tr> </thead> <tbody> <tr> <td>0</td> <td>0</td> <td>1</td> </tr> <tr> <td>0</td> <td>1</td> <td>0</td> </tr> <tr> <td>1</td> <td>0</td> <td>0</td> </tr> <tr> <td>1</td> <td>1</td> <td>0</td> </tr> </tbody> </table> </div> <p>AND—With this gate, if Input A AND Input B are <u>ON</u>, then the Output will be <u>ON</u>; so that any single Input change will not cause the Output to change unless the other Input is already ON.</p> <div style="display: flex; align-items: center; justify-content: center;">  <table border="1" style="margin-left: 20px;"> <thead> <tr> <th>A</th> <th>B</th> <th>Y</th> </tr> </thead> <tbody> <tr> <td>0</td> <td>0</td> <td>0</td> </tr> <tr> <td>0</td> <td>1</td> <td>0</td> </tr> <tr> <td>1</td> <td>0</td> <td>0</td> </tr> <tr> <td>1</td> <td>1</td> <td>1</td> </tr> </tbody> </table> </div>	A	B	Y	0	0	0	0	1	1	1	0	1	1	1	1	A	B	Y	0	0	1	0	1	0	1	0	0	1	1	0	A	B	Y	0	0	0	0	1	0	1	0	0	1	1	1
A	B	Y																																													
0	0	0																																													
0	1	1																																													
1	0	1																																													
1	1	1																																													
A	B	Y																																													
0	0	1																																													
0	1	0																																													
1	0	0																																													
1	1	0																																													
A	B	Y																																													
0	0	0																																													
0	1	0																																													
1	0	0																																													
1	1	1																																													

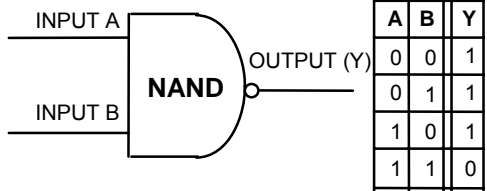
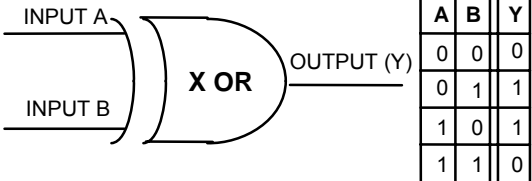
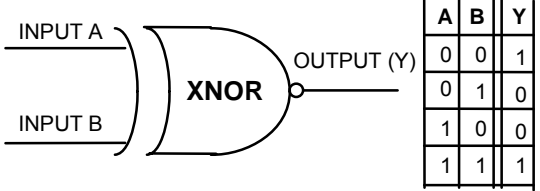
Function Prompt Lower Display	Selections or Range of Setting Upper Display	Parameter Definition															
	NAND	<p>NAND—<u>NOT AND</u> is the best way to describe the NAND gate. It is an inverted AND gate. When Input A and Input B are <u>ON</u>, the Output is <u>OFF</u>.</p>  <p>The diagram shows a NAND gate with two inputs, INPUT A and INPUT B, and one output, OUTPUT (Y). The truth table is as follows:</p> <table border="1" data-bbox="1258 430 1372 619"> <thead> <tr> <th>A</th> <th>B</th> <th>Y</th> </tr> </thead> <tbody> <tr> <td>0</td> <td>0</td> <td>1</td> </tr> <tr> <td>0</td> <td>1</td> <td>1</td> </tr> <tr> <td>1</td> <td>0</td> <td>1</td> </tr> <tr> <td>1</td> <td>1</td> <td>0</td> </tr> </tbody> </table>	A	B	Y	0	0	1	0	1	1	1	0	1	1	1	0
A	B	Y															
0	0	1															
0	1	1															
1	0	1															
1	1	0															
	X OR	<p>X OR (EXCLUSIVE OR)—The operation of this gate is, as its name implies, Exclusively “OR”. If Input A OR Input B is <u>ON</u>, the Output will be <u>ON</u>. If Input A and Input B are <u>ON</u> or <u>OFF</u>, the Output will be <u>OFF</u>.</p>  <p>The diagram shows an X OR gate with two inputs, INPUT A and INPUT B, and one output, OUTPUT (Y). The truth table is as follows:</p> <table border="1" data-bbox="1282 829 1396 1008"> <thead> <tr> <th>A</th> <th>B</th> <th>Y</th> </tr> </thead> <tbody> <tr> <td>0</td> <td>0</td> <td>0</td> </tr> <tr> <td>0</td> <td>1</td> <td>1</td> </tr> <tr> <td>1</td> <td>0</td> <td>1</td> </tr> <tr> <td>1</td> <td>1</td> <td>0</td> </tr> </tbody> </table>	A	B	Y	0	0	0	0	1	1	1	0	1	1	1	0
A	B	Y															
0	0	0															
0	1	1															
1	0	1															
1	1	0															
	XNOR	<p>X NOR (EXCLUSIVE NOR)—The EXCLUSIVE NOR is an inverted EXCLUSIVE OR. If Input A and Input B are <u>ON</u> or <u>OFF</u>, the Output will be <u>ON</u>.</p>  <p>The diagram shows an XNOR gate with two inputs, INPUT A and INPUT B, and one output, OUTPUT (Y). The truth table is as follows:</p> <table border="1" data-bbox="1282 1186 1404 1375"> <thead> <tr> <th>A</th> <th>B</th> <th>Y</th> </tr> </thead> <tbody> <tr> <td>0</td> <td>0</td> <td>1</td> </tr> <tr> <td>0</td> <td>1</td> <td>0</td> </tr> <tr> <td>1</td> <td>0</td> <td>0</td> </tr> <tr> <td>1</td> <td>1</td> <td>1</td> </tr> </tbody> </table>	A	B	Y	0	0	1	0	1	0	1	0	0	1	1	1
A	B	Y															
0	0	1															
0	1	0															
1	0	0															
1	1	1															

Function Prompt Lower Display	Selections or Range of Setting Upper Display	Parameter Definition
	DIG IN1 DIG IN2 DIG IN3 DIG IN4 RELAY 1 RELAY 2 RELAY 3 RELAY 4 RELAY 5 GATE1OT GATE2OT GATE3OT GATE4OT GATE5OT FIX ON FIX OFF MA MODE LR SPL1 ADAPT 1 MA MOD2 * LR SPL2 * ADAPT 2 * INPUT 1 INPUT 2 INPUT 3 INPUT 4 INPUT 5 L1 PV L1 SP CONST K L2 PV * L2 SP * * These prompts appear only when 2 Loops are configured.	DIGITAL INPUT 1 DIGITAL INPUT 2 DIGITAL INPUT 3 DIGITAL INPUT 4 RELAY 1 RELAY 2 RELAY 3 RELAY 4 RELAY 5 OUTPUT FROM GATE 1 OUTPUT FROM GATE 2 OUTPUT FROM GATE 3 OUTPUT FROM GATE 4 OUTPUT FROM GATE 5 ALWAYS A "1" ALWAYS A "0" Manual or Auto mode – Loop 1 0 = Manual 1 = Automatic Local or Remote Setpoint – Loop 1 0 = Local 1 = Remote Disable or Enable Adaptive Tune – Loop 1 0 = Disable 1 = Enable Manual or Auto Mode – Loop 2 0 = Manual 1 = Automatic Local or Remote Setpoint – Loop 2 0 = Local 1 = Remote Disable or Enable Adaptive Tune – Loop 2 0 = Disable 1 = Enable The following selections apply if the Gate Type is B LT A (B less than A) or B GT A (B greater than A). ANALOG INPUT 1 ANALOG INPUT 2 ANALOG INPUT 3 ANALOG INPUT 4 ANALOG INPUT 5 LOOP 1 PROCESS VARIABLE LOOP 1 SETPOINT K CONSTANT LOOP 2 PROCESS VARIABLE LOOP 2 SETPOINT
GATE(n) K (n) = 1, 2, 3, 4, or 5	-999.0 to +9999	GATE (n) K CONSTANT —This selection only appears if CONST K is configured for GATE(n)INA .

Function Prompt Lower Display	Selections or Range of Setting Upper Display	Parameter Definition
<p>GATE(n)INB (n = 1, 2, 3, 4, or 5)</p>	<p>DIG IN1 DIG IN2 DIG IN3 DIG IN4 RELAY 1 RELAY 2 RELAY 3 RELAY 4 RELAY 5 GATE1OT GATE2OT GATE3OT GATE4OT GATE5OT FIX ON FIX OFF</p> <p>MA MODE</p> <p>LR SPL1</p> <p>ADAPT1</p> <p>MA MOD2 *</p> <p>LR SPL2 *</p> <p>ADAPT 2 *</p>	<p>GATE (n) INPUT B—The selection here will indicate what Input B will be for any of the 5 Gates you want to configure.</p> <p>The following selections apply if the Gate Type is OR, NOR, AND, NAND, X OR, or X NOR.</p> <p>DIGITAL INPUT 1 DIGITAL INPUT 2 DIGITAL INPUT 3 DIGITAL INPUT 4 RELAY 1 RELAY 2 RELAY 3 RELAY 4 RELAY 5 OUTPUT FROM GATE 1 OUTPUT FROM GATE 2 OUTPUT FROM GATE 3 OUTPUT FROM GATE 4 OUTPUT FROM GATE 5 ALWAYS A “1” ALWAYS A “0”</p> <p>Manual or Auto mode – Loop 1 0 = Manual 1 = Automatic</p> <p>Local or Remote Setpoint – Loop 1 0 = Local 1 = Remote</p> <p>Disable or Enable Adaptive Tune – Loop 1 0 = Disable 1 = Enable</p> <p>Manual or Auto Mode – Loop 2 0 = Manual 1 = Automatic</p> <p>Local or Remote Setpoint – Loop 2 0 = Local 1 = Remote</p> <p>Disable or Enable Adaptive Tune – Loop 2 0 = Disable 1 = Enable</p>

Function Prompt Lower Display	Selections or Range of Setting Upper Display	Parameter Definition
	<p>INPUT 1 INPUT 2 INPUT 3 INPUT 4 INPUT 5 L1 PV L1 SP TOTALZE L2 PV * L2 SP *</p> <p>* These prompts appear only when 2 Loops are configured.</p>	<p>The following selections apply if the Gate Type is B LT A (B less than A) or B GT A (B greater than A).</p> <p>ANALOG INPUT 1 ANALOG INPUT 2 ANALOG INPUT 3 ANALOG INPUT 4 ANALOG INPUT 5 LOOP 1 PROCESS VARIABLE LOOP 1 SETPOINT TOTALIZER (see Note 1) LOOP 2 PROCESS VARIABLE LOOP 2 SETPOINT</p> <p>Note 1: The Input B Totalizer Value will be the displayed value, not the actual Totalizer value.</p>
<p>GATE(n)OUT (n = 1, 2, 3, 4, or 5)</p>	<p>RELAY 1 RELAY 2 RELAY 3 RELAY 4 RELAY 5 ANY GATE MA MODE</p> <p>LR SPL1</p> <p>ADAPT 1</p> <p>RESET T</p> <p>MA MOD2 *</p> <p>LR SPL2 *</p> <p>ADAPT 2 *</p> <p>* These prompts appear only when 2 Loops are configured.</p>	<p>GATE (n) OUTPUT—The selection here indicates what the output will be for any of the 5 gates that you configure.</p> <p>RELAY 1 RELAY 2 RELAY 3 RELAY 4 RELAY 5</p> <p>Output to any Gate Manual or Auto mode – Loop 1 0 = Manual 1 = Automatic</p> <p>Local or Remote Setpoint – Loop 1 0 = Local 1 = Remote</p> <p>Disable or Enable Adaptive Tune – Loop 1 0 = Disable 1 = Enable</p> <p>Disable or Enable Totalizer Reset 0 = Disable 1 = Enable</p> <p>Manual or Auto Mode – Loop 2 0 = Manual 1 = Automatic</p> <p>Local or Remote Setpoint – Loop 2 0 = Local 1 = Remote</p> <p>Disable or Enable Adaptive Tune – Loop 2 0 = Disable 1 = Enable</p>

3.14 Output Set Up Group

Introduction

This group deals with various output types in the controller, the Digital Output Status and the Current Output operation.

ATTENTION

If the controller is configured to use the same relay for more than one function, then the following priority is used to determine how the relay functions: Control Outputs take precedence over Alarms, which in turn take precedence over Time/Events, which in turn take precedence over Logic Gate Outputs. For example, if you select the Loop 2 Output Algorithm as Time Simplex (which uses Relay 3), enable Alarm 3 (which also uses Relay 3) and configure a Logic Gate to use Relay 3, then the instrument will use Relay #3 to perform the Time Simplex output and ignore the Alarm and Logic Gate functions.

The Tuning Group is automatically configured to have two PID sets when a Duplex Control Algorithm is selected.

Function Prompts

Table 3-14 OUTPUT Group Function Prompts

Function Prompt Lower Display	Selections or Range of Setting Upper Display	Parameter Definition
OUT ALG	TIME	<p>OUTPUT ALGORITHM—Lets you select the type of output you want. Not applicable with Control algorithm prompt 3PSTEP.</p> <p>Selections are hardware dependent. For example, if the controller does not have a relay output, then none of the prompts that need a relay output will appear. See Table 2-6 and Table 2-7 for other information about output types.</p> <p>ATTENTION For all Duplex Output forms, PID heat parameters (PID Set 1) apply for controller output greater than 50 %; PID cool parameters (PID Set 2) apply for controller output less than 50 %.</p> <p>TIME SIMPLEX—This output algorithm uses Relay1 for Time Proportional Control. Time Proportional Output has a resolution of 3.33 milliseconds with an adjustable Cycle Time (see Section 3.4).</p>

Function Prompt Lower Display	Selections or Range of Setting Upper Display	Parameter Definition
	<p>CURRENT</p> <p>POSPROP</p> <p>TIME D</p> <p>CUR D</p> <p>CUR TI</p> <p>TI CUR</p>	<p>CURRENT SIMPLEX—Type of output using a milliamp signal that can be fed into a positive or negative grounded load. This signal can easily be configured for 4-20 mA or 0-20 mA operation via the C1 RANGE configuration, below.</p> <p>POSITION PROPORTIONAL—Type of output using two relays to control a motor with a feedback slidewire.</p> <p>This output algorithm selection forces Input 3 to the SLIDEW selection when the Control Algorithm is any selection other than 3PSTEP.</p> <p>ATTENTION <i>Other prompts affected: DEADBAND.</i></p> <p>TIME DUPLEX—This output algorithm uses Relay 1 and Relay 2 for Duplex Time Proportional Control. Relay 1 is the HEAT output and Relay 2 is the COOL output. Time Proportional Output has a resolution of 3.33 milliseconds. Time Proportional Output has a resolution of 3.33 milliseconds with an adjustable Cycle Time (see Section 3.4).</p> <p>CURRENT DUPLEX—Similar to current simplex but uses a second current output. The second output is usually scaled so that zero and span correspond with 0 % and 50 % output (cool zone). When the output is 0 % to 50 %, the controller uses tuning parameter set #2. When the output is 50 % to 100 % it uses set #1.</p> <p>ATTENTION <i>Other prompts affected: OUT RNG</i></p> <p>CURRENT/TIME DUPLEX—A variation of duplex with current active for 0 % to 50 % output (tuning set 2) and time is active 50 % to 100 % output (tuning set 1). Relay controls heat, current controls cool.</p> <p>ATTENTION <i>Other prompts affected: OUT RNG</i></p> <p>TIME/CURRENT DUPLEX—Similar to CURRENT/TIME except that current is active for 50 % to 100 % and time is active for 0 % to 50 %. Relay controls COOL, current controls HEAT.</p> <p>ATTENTION <i>Other prompts affected: OUT RNG</i></p>
<p>OUT RNG</p>		<p>CURRENT DUPLEX RANGE ALGORITHM—Used with Output Algorithm selections CUR D, CUR TI, or TI CUR.</p>

Function Prompt Lower Display	Selections or Range of Setting Upper Display	Parameter Definition
RLYSTATE	1OF 2OF 1ON 2OF 1OF 2ON 1ON 2ON	DIGITAL OUTPUT STATUS AT 0 % OUTPUT — Allows the following selections: 1OF 2OF Output 1 de-energized Output 2 de-energized 1ON 2OF Output 1 energized Output 2 de-energized 1OF 2ON Output 1 de-energized Output 2 energized 1ON 2ON Output 1 energized Output 2 energized
RLY TYPE	MECHAN SOL ST	RELAY CYCLE TIME INCREMENT —Used only for Time Simplex and Duplex output configurations. This configuration sets the increment size of the relay cycle times in the Tuning and Tuning 2 Set Up groups. ELECTROMECHANICAL RELAY —Cycle time in one-second increments. SOLID STATE RELAY —Cycle time in 1/3-second increments. This is useful for solid-state relay applications that require shorter cycle times. DO NOT use this setting unless cycle times of less than 1 second are required. ATTENTION The Lockout selection must be set to NONE in order to view this selection.
MOTOR TI	5 to 1800 seconds	MOTOR TIME —Appears only when “POSPROP” is selected as the Output algorithm. This is the time it takes the motor to travel from 0 to 100% (fully closed to fully open). This time can usually be found on the nameplate of the motor.
OUT2 ALG	NONE TIME CURRENT TIME D CUR D CUR TI TI CUR	OUTPUT ALGORITHM —Selects the type of output desired for the second control loop. See OUT ALG for definitions. NONE TIME SIMPLEX CURRENT SIMPLEX TIME DUPLEX CURRENT DUPLEX CURRENT/TIME DUPLEX TIME/CURRENT DUPLEX ATTENTION Some of these configurations may not be available on Loop 2 if Loop 1 uses the available outputs. See Table 2-6 and Table 2-7 for information about output types and how they are used for each Loop.

Function Prompt Lower Display	Selections or Range of Setting Upper Display	Parameter Definition
	<p>TIME</p> <p>CURRENT</p> <p>TIME D</p> <p>CUR D</p> <p>CUR TI</p> <p>TI CUR</p>	<p>TIME SIMPLEX—This output algorithm uses Relay 3 for Time Proportional Control. Time Proportional Output has a resolution of 3.33 milliseconds with an adjustable Cycle Time (see Section 3.5).</p> <p>CURRENT SIMPLEX—Type of output using a milliamp signal that can be fed into a positive or negative grounded load. This signal can easily be configured for 4-20 mA or 0-20 mA operation via the C3 RANGE configuration, below.</p> <p>TIME DUPLEX—This output algorithm uses Relay 1 and Relay 2 for Duplex Time Proportional Control. Relay 1 is the HEAT output and Relay 2 is the COOL output. Time Proportional Output has a resolution of 3.33 milliseconds. Time Proportional Output has a resolution of 3.33 milliseconds with an adjustable Cycle Time (see Section 3.5).</p> <p>CURRENT DUPLEX—Similar to current simplex but uses a second current output. The second output is usually scaled so that zero and span correspond with 0 % and 50 % output (cool zone). When the output is 0 % to 50 %, the controller uses tuning parameter set #2. When the output is 50 % to 100 % it uses set #1.</p> <p>ATTENTION Other prompts affected: <i>OUT RNG</i></p> <p>CURRENT/TIME DUPLEX—A variation of duplex with current active for 0 % to 50 % output (tuning set 2) and time is active 50 % to 100 % output (tuning set 1). Relay controls heat, current controls cool.</p> <p>ATTENTION Other prompts affected: <i>OUT2 RNG</i></p> <p>TIME/CURRENT DUPLEX—Similar to CURRENT/TIME except that current is active for 50 % to 100 % and time is active for 0 % to 50 %. Relay controls COOL, current controls HEAT.</p> <p>ATTENTION Other prompts affected: <i>OUT2 RNG</i></p>
<p>OUT2 RNG</p>		<p>CURRENT DUPLEX RANGE ALGORITHM—Used with Output Algorithm selections CUR D, CUR TI, or TI CUR.</p>

Function Prompt Lower Display	Selections or Range of Setting Upper Display	Parameter Definition
<p>RLYSTAT2</p>	<p>1OF2OF</p>	<p>DIGITAL OUTPUT STATUS AT 0 % OUTPUT FOR LOOP 2—Allows the following selections:</p> <p>1OF2OF Output 1 de-energized Output 2 de-energized</p>
	<p>1ON2OF</p>	<p>1ON2OF Output 1 energized Output 2 de-energized</p>
	<p>1OF2ON</p>	<p>1OF2ON Output 1 de-energized Output 2 energized</p>
	<p>1ON2ON</p>	<p>1ON2ON Output 1 energized Output 2 energized</p>
<p>CUR OUT1</p>	<p>DISABLE</p>	<p>FIRST CURRENT OUTPUT—If the First Current Output is not used to perform one of the above output algorithms, it may be used to perform an Auxiliary Output function. This prompt will not show up when the First Current Output is used in one of the above output algorithms.</p> <p>NO FIRST CURRENT OUTPUT—Current Output disabled and output set to 0 mA.</p>
	<p>INPUT 1</p>	<p>INPUT 1—This represents the configured range of Input 1.</p> <p>FOR EXAMPLE: Input 1 Type = J Thermocouple (0 °F to 1600 °F) First Current Output Low Scale Value = 0.0 First Current Output High Scale Value = 1600 C1 Range = 4-20 mA Then: 0 °F display = 0 % output (4 mA) 800 °F display = 50 % output (12 mA) 1600 °F display = 100 % output (20 mA)</p>
	<p>INPUT 2</p>	<p>INPUT 2—Same as Input 1.</p>
	<p>INPUT 3</p>	<p>INPUT 3—Same as Input 1.</p>
	<p>INPUT 4</p>	<p>ATTENTION Do not configure Input 3 when input 3 is used for slidewire or slidewire emulation.</p> <p>INPUT 4—Same as Input 1.</p>
	<p>INPUT 5</p>	<p>INPUT 5—Same as Input 1.</p>

Function Prompt Lower Display	Selections or Range of Setting Upper Display	Parameter Definition
	<p>OUTPUT</p> <p>SP</p> <p>LSP 1</p> <p>RSP</p> <p>IN ALG1</p> <p>IN ALG2</p> <p>PV 2</p> <p>CBOU2L2</p>	<p>OUTPUT—Represents the displayed controller output in percent (%).</p> <p>ATTENTION Also see CB OUT when using a characterizer on the output value.</p> <p>ATTENTION When Position Proportional Control is configured as the Output Algorithm; OUTPUT represents the actual Slidewire Position whether in Automatic or Manual Mode. Should the Slidewire input fail for any reason, the Auxiliary Output will go to the value configured for FAILSAFE OUTPUT VALUE in the Control Setup Group.</p> <p>ATTENTION When Three Position Step Control (TPSC) is configured as the Control Algorithm; OUTPUT represents only the estimated motor position, not the actual motor position.</p> <p>SETPOINT—Represents the value of the setpoint currently in use (LSP1, LSP2, LSP3, RSP or CSP) and is shown in the same units as those used by the PV.</p> <p>LOCAL SETPOINT ONE—Output represents Local Setpoint 1 regardless of active setpoint.</p> <p>REMOTE SETPOINT—Represents the configured RSP regardless of the active SetPoint.</p> <p>INPUT ALGORITHM 1 OUTPUT—Represents the output from input algorithm 1.</p> <p>INPUT ALGORITHM 2 OUTPUT—Represents the output from input algorithm 2.</p> <p>PROCESS VARIABLE FOR LOOP 2—Represents the value of the Process Variable for Loop 2.</p> <p>CONTROL BLOCK OUTPUT FOR LOOP 2— Output for Loop 2 as calculated by the control block (such as PID A). When using one of the characterizers, OUTPUT 2 is the output value for Loop 2 after it passes through the characterizer. CB OUTL2 is the control block output before it passes through the characterizer.</p>

Function Prompt Lower Display	Selections or Range of Setting Upper Display	Parameter Definition
	DEV 2	<p>DEVIATION (PROCESS VARIABLE MINUS SETPOINT FOR LOOP 2)—Represents –100 % to +100 % of the selected PV span in engineering units.</p> <p>Zero deviation will produce a center scale (12 mA or 50 %) output. A negative deviation equal in magnitude to the Output High Scaling Factor will produce a low-end output (4mA or 0 %) output. A positive deviation equal in magnitude to the Output High Scaling Factor will produce a high-end output (20 mA or 100 %).</p> <p>FOR EXAMPLE: Configuration is as follows: Input 1 = Type T High Thermocouple PV range = –300 °F to +700 °F PV span = 1000 °F Deviation Range = –1000 to +1000 °F = 2000 °F Second Current Output Low Scale Value = 0.0 Second Current Output High Scale Value = 1000 C2 Range = 4-20 mA</p> <p>If PV = 500 °F and SP = 650 °F then Deviation Display = –150 °F, which is –150 / 2000 = –7.5% of the Deviation Range, so Second Current Output = 50% – 7.5% = 42.5% which is 0.425 X 16 mA + 4 mA = 10.8 Ma</p>
	OUTPUT 2	<p>OUTPUT FOR LOOP 2—Represents the displayed controller Loop 2 output in percent (%).</p>
	SP LP2	<p>SETPOINT FOR LOOP 2—Represents the value of the setpoint currently in use by Loop 2 (LSP1, LSP2, LSP3, RSP or CSP) and is shown in the same units as those used by the PV for Loop 2.</p>
	LSP1LP2	<p>LOCAL SETPOINT ONE FOR LOOP 2—Output represents Loop 2 Local Setpoint 1 regardless of active setpoint.</p>
	RSP LP2	<p>REMOTE SETPOINT FOR LOOP 2—Represents the configured Loop 2 RSP regardless of the active SetPoint for Loop 2.</p>

Function Prompt Lower Display	Selections or Range of Setting Upper Display	Parameter Definition
LOW VAL	Low Scale Value within the range of the selected variable to represent the minimum output (0 or 4 mA)	<p>CURRENT OUTPUT LOW SCALING FACTOR— Used only when CUR OUT is any selection other than DISABLE. This is a value in engineering units used to represent all CUR OUT parameters except Output.</p> <p>For Output, this is a value in percent and can be any value between –5 % and +105 %. However, keep in mind that relay output types can only be scaled 0 % to 100 %.</p>
HIGH VAL	High Scale Value within the range of the selected variable to represent the maximum output (20 mA)	<p>CURRENT OUTPUT HIGH SCALING FACTOR— Used only when CUR OUT is any selection other than DISABLE. This is a value in engineering units used to represent all CUR OUT parameters except Output.</p> <p>For Output, this is a value in percent and can be any value between –5 % and +105 %. However, keep in mind that relay output types can only be scaled 0 % to 100 %.</p>

3.15 Input 1 Set Up Group

Introduction

This data deals with various parameters required to configure Input 1.

Function Prompts

Table 3-15 INPUT 1 Group Function Prompts

Function Prompt Lower Display	Selections or Range of Setting Upper Display	Parameter Definition
<p>IN1 TYPE</p> <p>ATTENTION Changing the input type will result in the loss of Field Calibration values and will restore Factory Calibration values.</p>	<p>DISABLE B TC E TC H E TC L J TC H J TC M J TC L K TC H K TC M K TC L NNM H NNM L NIC H NIC L PLAT H PLAT L R TC S TC T TC H T TC L W TC H W TC L 100 PT 100 LO 200 PT 500 PT 1000 PT RAD RH RAD RI 0-20mA 4-20mA 0-10mV 0-50mV 0-100mV 0-500mV -10-10m 0-1 V 0-5 V 1-5 V 0-10 V -1-1 V</p>	<p>INPUT 1 ACTUATION TYPE—This selection determines what actuation you are going to use for Input 1.</p> <p>DISABLE—Disables Input. B TC—B Thermocouple E TC H—E Thermocouple High E TC L—E Thermocouple Low J TC H—J Thermocouple High J TC M—J Thermocouple Med J TC L—J Thermocouple Low K TC H—K Thermocouple High K TC M—K Thermocouple Med K TC L—K Thermocouple Low NNM H—Ni-Ni-Moly Thermocouple High NNM L—Ni-Ni-Moly Thermocouple Low NIC H—Nicrosil-Nisil Thermocouple High NIC L—Nicrosil-Nisil Thermocouple Low PLATINEL H—Platinel II Thermocouple High PLATINEL L—Platinel II Thermocouple Low R TC—R Thermocouple S TC—S Thermocouple T TC H—T Thermocouple High T TC L—T Thermocouple Low W TC H—W5W26 Thermocouple High W TC L—W5W26 Thermocouple Low 100 PT—100 Ohm RTD High 100 LO—100 Ohm RTD Low 200 PT—200 Ohm RTD 500 PT—500 Ohm RTD 1000 PT—1000 Ohm RTD RAD RH—Radiamatic RH RAD RI—Radiamatic RI 0-20mA—0 to 20 Milliamperes 4-20mA—4 to 20 Milliamperes 0-10mV—0 to 10 Millivolts 0-50mV—0 to 50 Millivolts 0-100mV—0 to 100 Millivolts 0-500mV—0 to 500 Millivolts -10-10mV— -10 to +10 Millivolts 0-1 V—0 to 1 Volts 0-5 V—0 to 5 Volts 1-5 V—1 to 5 Volts 0-10 V—0 to 10 Volts -1-1 V— -1 to +1 Volts</p>

Function Prompt Lower Display	Selections or Range of Setting Upper Display	Parameter Definition																														
	TC DIFF CARBON OXYGEN PR	<p>TC DIFF—Thermocouple Differential Carbon—Carbon Probe Input Oxygen—Oxygen Probe Input PR—PR40-PR20 Thermocouple</p>																														
XMITTER1	<table border="0"> <tr><td>B TC</td><td>R TC</td></tr> <tr><td>E TC H</td><td>S TC</td></tr> <tr><td>E TC L</td><td>T TC H</td></tr> <tr><td>J TC H</td><td>T TC L</td></tr> <tr><td>J TC M</td><td>W TC H</td></tr> <tr><td>J TC L</td><td>W TC L</td></tr> <tr><td>K TC H</td><td>100 PT</td></tr> <tr><td>K TC M</td><td>100 LO</td></tr> <tr><td>K TC L</td><td>200 PT</td></tr> <tr><td>NNM H</td><td>500 PT</td></tr> <tr><td>NNM L</td><td>RAD RH</td></tr> <tr><td>NIC H</td><td>RAD RI</td></tr> <tr><td>NIC L</td><td>LINEAR</td></tr> <tr><td>PLAT H</td><td>SQROOT</td></tr> <tr><td>PLAT L</td><td></td></tr> </table>	B TC	R TC	E TC H	S TC	E TC L	T TC H	J TC H	T TC L	J TC M	W TC H	J TC L	W TC L	K TC H	100 PT	K TC M	100 LO	K TC L	200 PT	NNM H	500 PT	NNM L	RAD RH	NIC H	RAD RI	NIC L	LINEAR	PLAT H	SQROOT	PLAT L		<p>TRANSMITTER CHARACTERIZATION—This selection lets you instruct the controller to characterize a linear input to represent a non-linear one. If characterization is performed by the transmitter itself, then select LINEAR.</p> <p>ATTENTION Prompt only appears when a linear actuation is selected at prompt IN1 TYPE.</p> <p>FOR EXAMPLE: If Input 1 is a 4 to 20 mA signal, but the signal represents a type K H thermocouple, then configure K TC H and the controller will characterize the 4 to 20 mA signal so that it is treated as a type K thermocouple input (high range).</p> <p>Parameter definitions are the same as in IN1 TYPE.</p>
B TC	R TC																															
E TC H	S TC																															
E TC L	T TC H																															
J TC H	T TC L																															
J TC M	W TC H																															
J TC L	W TC L																															
K TC H	100 PT																															
K TC M	100 LO																															
K TC L	200 PT																															
NNM H	500 PT																															
NNM L	RAD RH																															
NIC H	RAD RI																															
NIC L	LINEAR																															
PLAT H	SQROOT																															
PLAT L																																
IN1 HIGH	-999. To 9999. Floating (in engineering units)	<p>INPUT 1 HIGH RANGE VALUE—This value in engineering units is displayed for all inputs but can only be changed for inputs configured for linear or square root transmitter characterization.</p> <p>For Inputs with Linear or Square Root transmitter characterization, you can scale the Input signal to display the values you want for 0 % and 100 %.</p> <p>EXAMPLE: Process Variable = Flow Range of Flow = 0 to 250 Liters/Minute Actuation (Input 1) = 4 to 20 mA Characterization (XMITTER 1) = LINEAR Set IN1 HIGH value to 250 Set IN1 LOW value to 0 Then: 4 mA = 0 Liters/Minute 12 mA = 125 Liters/Minute 20 mA = 250 Liters/Minute</p> <p>ATTENTION If Input 1 is selected as the PV Source, then the range of the control Setpoint will be limited by the range of units selected here.</p>																														

Function Prompt Lower Display	Selections or Range of Setting Upper Display	Parameter Definition
IN1 LOW	–999. To 9999. Floating (in engineering units)	<p>INPUT 1 LOW RANGE VALUE—This value in engineering units is displayed for all inputs but can only be changed for inputs configured for linear or square root transmitter characterization.</p> <p>See the example in IN1 HI.</p> <p>ATTENTION If Input 1 is selected as the PV Source, then the range of the control Setpoint will be limited by the range of units selected here.</p>
RATIO 1	–20.00 to 20.00 Floats to 3 decimal places	<p>RATIO ON INPUT 1—Select the Ratio value you want on Input 1.</p>
BIAS IN1	–999. to 9999. (in engineering units)	<p>BIAS ON INPUT 1—Bias is used to compensate the input for drift of an input value due to deterioration of a sensor, or some other cause. Select the bias value you want on Input 1.</p> <p>Final Input 1 Value = Input 1 * Ratio 1 + Bias 1</p> <p>FOR EXAMPLE:</p> <p>Input 1 Type = 100 ohm RTD (-300 °F to 1200 °F) Input 1 Ratio = 0.5 Input 1 Bias = 15.7</p> <p>If Input 1 = -200 °F Then Final Input 1 = -200 * 0.5 + 15.7 = -84.3</p> <p>If Input 1 = 0 °F Then Final Input 1 = 0 * 0.5 + 15.7 = 15.7</p> <p>If Input 1 = 500 °F Then Final Input 1 = 500 * 0.5 + 15.7 = 265.7</p>
FILTER 1	0 to 120 seconds No filter = 0	<p>FILTER FOR INPUT 1—A software digital filter is provided for Input 1 to smooth the input signal. You can configure the first order lag time constant from 1 to 120 seconds. If you do not want filtering, enter 0.</p>
BURNOUT1		<p>BURNOUT PROTECTION (SENSOR BREAK)—Provides most input types with upscale or downscale protection if the input fails.</p> <p>ATTENTION For Burnout to function properly on 0-20 mA, 0-10 Volt or –1 to +1 Volt input types (or a 0-5V type that uses a dropping resistor), the dropping resistor must be remotely located (across the transmitter terminals). Otherwise, the input at the instrument terminals will always be 0 (i.e., within the normal operating range) when the sensor opens.</p>

Function Prompt Lower Display	Selections or Range of Setting Upper Display	Parameter Definition
	<p>NONE</p> <p>UP</p> <p>DOWN</p> <p>NO FS</p>	<p>NO BURNOUT—Input 1 display freezes at the last valid value. If Input 1 is used for PV, then the instrument assumes its pre-configured Failsafe Output (selected in the CONTROL Set up Group) when a failed input condition is detected (does not apply for an input out of range). Diagnostic message IN1 FAIL is intermittently flashed on the lower display.</p> <p>UPSCALE BURNOUT—Forces the Input 1 signal to the full-scale value when the sensor fails. Diagnostic message IN1 FAIL intermittently flashed on the lower display.</p> <p>The controller remains in Automatic control mode and adjusts the controller output signal accordingly.</p> <p>DOWNSCALE BURNOUT—Forces the Input 1 signal to the lower range value when the sensor fails. Diagnostic message IN1 FAIL intermittently flashed on the lower display.</p> <p>The controller remains in Automatic control mode and adjusts the controller output signal accordingly.</p> <p>NO FAILSAFE—This selection does not provide input failure detection and should only be used when a thermocouple input is connected to another instrument, which supplies the Burnout current. (For this selection, no burnout signal is sent to the sensor.)</p> <p>ATTENTION The Thermocouple Health feature is disabled when NO FS is configured.</p>
EMISSIV1	0.01 to 1.00	<p>EMISSIVITY—A correction factor applied to the Radiamatic input signal that is the ratio of the actual energy emitted from the target to the energy that would be emitted if the target were a perfect radiator. Available only for Radiamatic inputs.</p>

3.16 Input 2 Set Up Group

Introduction

This data deals with various parameters required to configure Input 2.

Function Prompts

Table 3-16 INPUT 2 Group Function Prompts

Function Prompt Lower Display	Selections or Range of Setting Upper Display	Parameter Definition
<p>IN2 TYPE</p> <p>ATTENTION Changing the input type will result in the loss of Field Calibration values and will restore Factory Calibration values.</p>	<p>DISABLE B TC E TC H E TC L J TC H J TC M J TC L K TC H K TC M K TC L NNM H NNM L NIC H NIC L PLAT H PLAT L R TC S TC T TC H T TC L W TC H W TC L 100 PT 100 LO 200 PT 500 PT 1000 PT RAD RH RAD RI 0-20mA 4-20mA 0-10mV 0-50mV 0-100mV 0-500mV -10-10m 0-1 V 0-5 V 1-5 V 0-10 V -1-1 V</p>	<p>INPUT 2 ACTUATION TYPE— This selection determines what actuation you are going to use for Input 2.</p> <p>DISABLE—Disables Input. B TC—B Thermocouple E TC H—E Thermocouple High E TC L—E Thermocouple Low J TC H—J Thermocouple High J TC M—J Thermocouple Med J TC L—J Thermocouple Low K TC H—K Thermocouple High K TC M—K Thermocouple Med K TC L—K Thermocouple Low NNM H—Ni-Ni-Moly Thermocouple High NNM L—Ni-Ni-Moly Thermocouple Low NIC H—Nicrosil-Nisil Thermocouple High NIC L—Nicrosil-Nisil Thermocouple Low PLATINEL H—Platinel II Thermocouple High PLATINEL L—Platinel II Thermocouple Low R TC—R Thermocouple S TC—S Thermocouple T TC H—T Thermocouple High T TC L—T Thermocouple Low W TC H—W5W26 Thermocouple High W TC L—W5W26 Thermocouple Low 100 PT—100 Ohm RTD High 100 LO—100 Ohm RTD Low 200 PT—200 Ohm RTD 500 PT—500 Ohm RTD 1000 PT—1000 Ohm RTD RAD RH—Radiamatic RH RAD RI—Radiamatic RI 0-20mA—0 to 20 Milliamperes 4-20mA—4 to 20 Milliamperes 0-10mV—0 to 10 Millivolts 0-50mV—0 to 50 Millivolts 0-100mV—0 to 100 Millivolts 0-500mV—0 to 500 Millivolts -10-10mV— -10 to +10 Millivolts 0-1 V—0 to 1 Volts 0-5 V—0 to 5 Volts 1-5 V—1 to 5 Volts 0-10 V—0 to 10 Volts -1-1 V— -1 to +1 Volts</p>

Function Prompt Lower Display	Selections or Range of Setting Upper Display	Parameter Definition
	TC DIFF PR	TC DIFF —Thermocouple Differential PR —PR40-PR20 Thermocouple
XMITTER2	B TC R TC E TC H S TC E TC L T TC H J TC H T TC L J TC M W TC H J TC L W TC L K TC H 100 PT K TC M 100 LO K TC L 200 PT NNM H 500 PT NNM L RAD RH NIC H RAD RI NIC L LINEAR PLAT H SQROOT PLAT L	TRANSMITTER CHARACTERIZATION —This selection lets you instruct the controller to characterize a linear input to represent a non-linear one. If characterization is performed by the transmitter itself, then select LINEAR. ATTENTION Prompt only appears when a linear actuation is selected at prompt IN1 TYPE. FOR EXAMPLE: If Input 2 is a 4 to 20 mA signal, but the signal represents a type K H thermocouple, then configure K TC H and the controller will characterize the 4 to 20 mA signal so that it is treated as a type K thermocouple input (high range). Parameter definitions are the same as in IN2 TYPE.
IN2 HIGH	–999. To 9999. Floating (in engineering units)	INPUT 2 HIGH RANGE VALUE —This value in engineering units is displayed for all inputs but can only be changed for inputs configured for linear or square root transmitter characterization. See the example in IN1 HI.
IN2 LOW	–999. To 9999. Floating (in engineering units)	INPUT 2 LOW RANGE VALUE —This value in engineering units is displayed for all inputs but can only be changed for inputs configured for linear or square root transmitter characterization. See the example in IN1 HI.
RATIO 2	–20.00 to 20.00 Floats to 3 decimal places	RATIO ON INPUT 2 —Select the Ratio value you want on Input 2.
BIAS IN2	–999. to 9999. (in engineering units)	BIAS ON INPUT 2 —Bias is used to compensate the input for drift of an input value due to deterioration of a sensor, or some other cause. Select the bias value you want on Input 2. Final Input 2 Value = Input 2 * Ratio 2 + Bias 2
FILTER 2	0 to 120 seconds No filter = 0	FILTER FOR INPUT 2 —A software digital filter is provided for Input 2 to smooth the input signal. You can configure the first order lag time constant from 1 to 120 seconds. If you do not want filtering, enter 0.

Function Prompt Lower Display	Selections or Range of Setting Upper Display	Parameter Definition
BURNOUT2	<p>NONE</p> <p>UP</p> <p>DOWN</p> <p>NO FS</p>	<p>BURNOUT PROTECTION (SENSOR BREAK)— Provides most input types with upscale or downscale protection if the input fails.</p> <p>ATTENTION For Burnout to function properly on 0-20 mA, 0-10 Volt or –1 to +1 Volt input types (or a 0-5V type that uses a dropping resistor), the dropping resistor must be remotely located (across the transmitter terminals). Otherwise, the input at the instrument terminals will always be 0 (i.e., within the normal operating range) when the sensor opens.</p> <p>NO BURNOUT—Input 2 display freezes at the last valid value. If Input 2 is used for PV, then the instrument assumes its pre-configured Failsafe Output (selected in the CONTROL Set up Group) when a failed input condition is detected (does not apply for an input out of range). Diagnostic message IN2 FAIL is intermittently flashed on the lower display.</p> <p>UPSCALE BURNOUT—Forces the Input 2 signal to the full-scale value when the sensor fails. Diagnostic message IN2 FAIL intermittently flashed on the lower display.</p> <p>The controller remains in Automatic control mode and adjusts the controller output signal accordingly.</p> <p>DOWNSCALE BURNOUT—Forces the Input 2 signal to the lower range value when the sensor fails. Diagnostic message IN2 FAIL intermittently flashed on the lower display.</p> <p>The controller remains in Automatic control mode and adjusts the controller output signal accordingly.</p> <p>NO FAILSAFE—This selection does not provide input failure detection and should only be used when a thermocouple input is connected to another instrument that supplies the Burnout current. (For this selection, no burnout signal is sent to the sensor.)</p> <p>ATTENTION The Thermocouple Health feature is disabled when NO FS is configured.</p>
EMISSIV2	0.01 to 1.00	<p>EMISSIVITY—A correction factor applied to the Radiamatic input signal that is the ratio of the actual energy emitted from the target to the energy that would be emitted if the target were a perfect radiator. Available only for Radiamatic inputs.</p>

3.17 Input 3 Set Up Group

Introduction

This data deals with various parameters required to configure Input 3.

Function Prompts

Table 3-17 INPUT 3 Group Function Prompts

Function Prompt Lower Display	Selections or Range of Setting Upper Display	Parameter Definition
<p>IN3 TYPE</p> <p>ATTENTION Changing the input type will result in the loss of Field Calibration values and will restore Factory Calibration values.</p> <p>Selecting Position Proportional Control in the Output Setup Group forces Input 3 to the Slidewire Selection.</p>	<p>DISABLE</p> <p>B TC</p> <p>E TC H</p> <p>E TC L</p> <p>J TC H</p> <p>J TC M</p> <p>J TC L</p> <p>K TC H</p> <p>K TC M</p> <p>K TC L</p> <p>NNM H</p> <p>NNM L</p> <p>NIC H</p> <p>NIC L</p> <p>PLAT H</p> <p>PLAT L</p> <p>R TC</p> <p>S TC</p> <p>T TC H</p> <p>T TC L</p> <p>W TC H</p> <p>W TC L</p> <p>100 PT</p> <p>100 LO</p> <p>200 PT</p> <p>500 PT</p> <p>1000 PT</p> <p>RAD RH</p> <p>RAD RI</p> <p>0-20mA</p> <p>4-20mA</p> <p>0-10mV</p> <p>0-50mV</p> <p>0-100mV</p> <p>0-500mV</p> <p>-10-10m</p> <p>0-1 V</p> <p>0-5 V</p> <p>1-5 V</p> <p>0-10 V</p> <p>-1-1 V</p>	<p>INPUT 3 ACTUATION TYPE—This selection determines what actuation you are going to use for Input 3.</p> <p>DISABLE—Disables Input.</p> <p>B TC—B Thermocouple</p> <p>E TC H—E Thermocouple High</p> <p>E TC L—E Thermocouple Low</p> <p>J TC H—J Thermocouple High</p> <p>J TC M—J Thermocouple Med</p> <p>J TC L—J Thermocouple Low</p> <p>K TC H—K Thermocouple High</p> <p>K TC M—K Thermocouple Med</p> <p>K TC L—K Thermocouple Low</p> <p>NNM H—Ni-Ni-Moly Thermocouple High</p> <p>NNM L—Ni-Ni-Moly Thermocouple Low</p> <p>NIC H—Nicrosil-Nisil Thermocouple High</p> <p>NIC L—Nicrosil-Nisil Thermocouple Low</p> <p>PLATINEL H—Platinel II Thermocouple High</p> <p>PLATINEL L—Platinel II Thermocouple Low</p> <p>R TC—R Thermocouple</p> <p>S TC—S Thermocouple</p> <p>T TC H—T Thermocouple High</p> <p>T TC L—T Thermocouple Low</p> <p>W TC H—W5W26 Thermocouple High</p> <p>W TC L—W5W26 Thermocouple Low</p> <p>100 PT—100 Ohm RTD High</p> <p>100 LO—100 Ohm RTD Low</p> <p>200 PT—200 Ohm RTD</p> <p>500 PT—500 Ohm RTD</p> <p>1000 PT—1000 Ohm RTD</p> <p>RAD RH—Radiamatic RH</p> <p>RAD RI—Radiamatic RI</p> <p>0-20mA—0 to 20 Milliamperes</p> <p>4-20mA—4 to 20 Milliamperes</p> <p>0-10mV—0 to 10 Millivolts</p> <p>0-50mV—0 to 50 Millivolts</p> <p>0-100mV—0 to 100 Millivolts</p> <p>0-500mV—0 to 500 Millivolts</p> <p>-10-10mV— -10 to +10 Millivolts</p> <p>0-1 V—0 to 1 Volts</p> <p>0-5 V—0 to 5 Volts</p> <p>1-5 V—1 to 5 Volts</p> <p>0-10 V—0 to 10 Volts</p> <p>-1-1 V— -1 to +1 Volts</p>

Function Prompt Lower Display	Selections or Range of Setting Upper Display	Parameter Definition																														
	SLIDEW TC DIFF SW EMUL PR	SLIDEWIRE —Slidewire for Position Proportional TC DIFF —Thermocouple Differential SLIDEWIRE EMULATION —Herculine Slidewire Emulation PR —PR40-PR20 Thermocouple																														
XMITTER3	<table border="0"> <tr> <td>B TC</td> <td>R TC</td> </tr> <tr> <td>E TC H</td> <td>S TC</td> </tr> <tr> <td>E TC L</td> <td>T TC H</td> </tr> <tr> <td>J TC H</td> <td>T TC L</td> </tr> <tr> <td>J TC M</td> <td>W TC H</td> </tr> <tr> <td>J TC L</td> <td>W TC L</td> </tr> <tr> <td>K TC H</td> <td>100 PT</td> </tr> <tr> <td>K TC M</td> <td>100 LO</td> </tr> <tr> <td>K TC L</td> <td>200 PT</td> </tr> <tr> <td>NNM H</td> <td>500 PT</td> </tr> <tr> <td>NNM L</td> <td>RAD RH</td> </tr> <tr> <td>NIC H</td> <td>RAD RI</td> </tr> <tr> <td>NIC L</td> <td>LINEAR</td> </tr> <tr> <td>PLAT H</td> <td>SQROOT</td> </tr> <tr> <td>PLAT L</td> <td></td> </tr> </table>	B TC	R TC	E TC H	S TC	E TC L	T TC H	J TC H	T TC L	J TC M	W TC H	J TC L	W TC L	K TC H	100 PT	K TC M	100 LO	K TC L	200 PT	NNM H	500 PT	NNM L	RAD RH	NIC H	RAD RI	NIC L	LINEAR	PLAT H	SQROOT	PLAT L		<p>TRANSMITTER 3 CHARACTERIZATION—This selection lets you instruct the controller to characterize a linear input to represent a non-linear one.</p> <p>ATTENTION Prompt only appears when a linear actuation is selected at prompt IN3 TYPE.</p> <p>FOR EXAMPLE: If Input 3 is a 4 to 20 mA signal, but the signal represents a type K thermocouple, then select K TC H and the controller will characterize the 4 to 20 mA signal so that it is treated as a type K thermocouple input (high range).</p> <p>Parameter definitions are the same as in IN3 TYPE.</p>
B TC	R TC																															
E TC H	S TC																															
E TC L	T TC H																															
J TC H	T TC L																															
J TC M	W TC H																															
J TC L	W TC L																															
K TC H	100 PT																															
K TC M	100 LO																															
K TC L	200 PT																															
NNM H	500 PT																															
NNM L	RAD RH																															
NIC H	RAD RI																															
NIC L	LINEAR																															
PLAT H	SQROOT																															
PLAT L																																
IN3 HIGH	–999. To 9999. Floating (in engineering units)	<p>INPUT 3 HIGH RANGE VALUE—This value in engineering units is displayed for all inputs but can only be changed for inputs configured for linear or square root transmitter characterization.</p> <p>See the example in IN1 HI.</p>																														
IN3 LOW	–999. To 9999. Floating (in engineering units)	<p>INPUT 3 LOW RANGE VALUE—This value in engineering units is displayed for all inputs but can only be changed for inputs configured for linear or square root transmitter characterization.</p> <p>See the example in IN1 HI</p>																														
RATIO 3	–20.00 to 20.00 Floats to 3 decimal places	RATIO ON INPUT 3 —Select the Ratio value you want on Input 3.																														
BIAS IN3	–999. to 9999. (in engineering units)	<p>BIAS ON INPUT 3—Bias is used to compensate the input for drift of an input value due to deterioration of a sensor, or some other cause. Select the bias value you want on Input 3.</p> <p>Final Input 3 Value = Input 3 * Ratio 3 + Bias 3</p>																														
FILTER 3	0 to 120 seconds No filter = 0	FILTER FOR INPUT 3 —A software digital filter is provided for Input 3 to smooth the input signal. You can configure the first order lag time constant from 1 to 120 seconds. If you do not want filtering, enter 0.																														

Function Prompt Lower Display	Selections or Range of Setting Upper Display	Parameter Definition
BURNOUT3	<p>NONE</p> <p>UP</p> <p>DOWN</p> <p>NO FS</p>	<p>BURNOUT PROTECTION (SENSOR BREAK)— Provides most input types with upscale or downscale protection if the input fails.</p> <p>ATTENTION For Burnout to function properly on 0-20 mA, 0-10 Volt or -1 to +1 Volt input types (or a 0-5V type that uses a dropping resistor), the dropping resistor must be remotely located (across the transmitter terminals). Otherwise, the input at the instrument terminals will always be 0 (i.e., within the normal operating range) when the sensor opens.</p> <p>NO BURNOUT—Input 3 display freezes at the last valid value. If Input 3 is used for PV, then the instrument assumes its pre-configured Failsafe Output (selected in the CONTROL Set up Group) when a failed input condition is detected (does not apply for an input out of range). Diagnostic message IN3 FAIL is intermittently flashed on the lower display.</p> <p>UPSCALE BURNOUT—Forces the Input 3 signal to the full-scale value when the sensor fails. Diagnostic message IN3 FAIL intermittently flashed on the lower display.</p> <p>The controller remains in Automatic control mode and adjusts the controller output signal accordingly.</p> <p>DOWNSCALE BURNOUT—Forces the Input 3 signal to the lower range value when the sensor fails. Diagnostic message IN3 FAIL intermittently flashed on the lower display.</p> <p>The controller remains in Automatic control mode and adjusts the controller output signal accordingly.</p> <p>NO FAILSAFE—This selection does not provide input failure detection and should only be used when a thermocouple input is connected to another instrument that supplies the Burnout current. (For this selection, no burnout signal is sent to the sensor.)</p> <p>ATTENTION The Thermocouple Health feature is disabled when NO FS is configured.</p>
EMISSIV3	0.01 to 1.00	<p>EMISSIVITY—A correction factor applied to the Radiamatic input signal that is the ratio of the actual energy emitted from the target to the energy that would be emitted if the target were a perfect radiator. Available only for Radiamatic inputs.</p>

3.18 Input 4 Set Up Group

Introduction

This data deals with various parameters required to configure Input 4. **Input 4 prompts are not available unless Input 2 Type is set to 0-5V, 1-5V, 0-20mA or 4-20mA.**

Function Prompts

Table 3-18 INPUT 4 Group Function Prompts

Function Prompt Lower Display	Selections or Range of Setting Upper Display	Parameter Definition
<p>IN4 TYPE</p> <p>ATTENTION Changing the input type will result in the loss of Field Calibration values and will restore Factory Calibration values.</p> <p>Input 4 prompts will not be available unless Input 2 Type is set to 0-5V, 1-5V, 0-20mA or 4-20mA.</p>	<p>DISABLE 0-20mA 4-20mA 0-5 V 1-5 V</p>	<p>INPUT 4 ACTUATION TYPE—This selection determines what actuation you are going to use for Input 4.</p> <p>DISABLE—Disables Input 0-20mA—0 to 20 Milliamperes 4-20mA—4 to 20 Milliamperes 0-5 V—0 to 5 Volts 1-5 V—1 to 5 Volts</p>
<p>XMITTER4</p>	<p>B TC R TC E TC H S TC E TC L T TC H J TC H T TC L J TC M W TC H J TC L W TC L K TC H 100 PT K TC M 100 LO K TC L 200 PT NNM H 500 PT NNM L RAD RH NIC H RAD RI NIC L LINEAR PLAT H SQROOT PLAT L</p>	<p>TRANSMITTER 4 CHARACTERIZATION—This selection lets you instruct the controller to characterize a linear input to represent a non-linear one.</p> <p>ATTENTION Parameter definitions are the same as in IN1 TYPE.</p>
<p>IN4 HIGH</p>	<p>–999. To 9999. Floating (in engineering units)</p>	<p>INPUT 4 HIGH RANGE VALUE—This value in engineering units is displayed for all inputs but can only be changed for inputs configured for linear or square root transmitter characterization.</p> <p>See the example in IN1 HI.</p>

3.19 Input 5 Set Up Group

Introduction

This data deals with various parameters required to configure Input 5. **Input 5 prompts are not available unless Input 3 Type is set to 0-5V, 1-5V, 0-20mA or 4-20mA.**

Function Prompts

Table 3-19 INPUT 5 Group Function Prompts

Function Prompt Lower Display	Selections or Range of Setting Upper Display	Parameter Definition
<p>IN5 TYPE</p> <p>ATTENTION Changing the input type will result in the loss of Field Calibration values and will restore Factory Calibration values.</p> <p>Input 5 prompts will not be available unless Input 3 Type is set to 0-5V, 1-5V, 0-20mA or 4-20mA.</p>	<p>DISABLE 0-20mA 4-20mA 0-5 V 1-5 V</p>	<p>INPUT 5 ACTUATION TYPE—This selection determines what actuation you are going to use for Input 5.</p> <p>DISABLE—Disables Input 0-20mA—0 to 20 Milliamperes 4-20mA—4 to 20 Milliamperes 0-5 V—0 to 5 Volts 1-5 V—1 to 5 Volts</p>
<p>XMITTER5</p>	<p>B TC R TC E TC H S TC E TC L T TC H J TC H T TC L J TC M W TC H J TC L W TC L K TC H 100 PT K TC M 100 LO K TC L 200 PT NNM H 500 PT NNM L RAD RH NIC H RAD RI NIC L LINEAR PLAT H SQROOT PLAT L</p>	<p>TRANSMITTER 5 CHARACTERIZATION—This selection lets you instruct the controller to characterize a linear input to represent a non-linear one.</p> <p>ATTENTION Parameter definitions are the same as in IN1 TYPE.</p>
<p>IN5 HIGH</p>	<p>–999. To 9999. Floating (in engineering units)</p>	<p>INPUT 5 HIGH RANGE VALUE—This value in engineering units is displayed for all inputs but can only be changed for inputs configured for linear or square root transmitter characterization.</p> <p>See the example in IN1 HI.</p>

Function Prompt Lower Display	Selections or Range of Setting Upper Display	Parameter Definition
<p>PID SETS (continued)</p>	<p>2PV SW</p>	<p>TWO SETS PV AUTOMATIC SWITCHOVER— When the process variable is LESS than the value set at prompt SW VALUE (Switchover Value), the controller will use Gain, Rate, and Reset. The active PID SET can be read in the lower display.</p> <p>When the process variable is GREATER than the value set at prompt SW VALUE, the controller will use Gain #2, Rate #2, and Reset #2. The active PID SET can be read in the lower display.</p> <p>ATTENTION <i>Other prompts affected: SW VALUE</i> Note: This operation is different from other UDC Controllers.</p>
	<p>2SP SW</p>	<p>TWO SETS SP AUTOMATIC SWITCHOVER— When the setpoint is LESS than the value set at prompt SW VALUE (Switchover Value), the controller will use Gain, Rate, and Reset.</p> <p>When the setpoint is GREATER than the value set at prompt SW VALUE, the controller will use Gain #2, Rate #2, and Reset #2.</p> <p>ATTENTION <i>Other prompts affected: SW VALUE.</i> Note: This operation is different from other UDC Controllers.</p>
	<p>4SP SW</p>	<p>FOUR SETS SP AUTOMATIC SWITCHOVER— When the setpoint is LESS than the value set at prompt SW VALUE (Switchover Value), the controller will use Gain, Rate, and Reset.</p> <p>When the setpoint is GREATER than the value set at prompt SW VALUE, the controller will use Gain #2, Rate #2, and Reset #2.</p> <p>Similarly, the controller switches between the other PID sets based upon the values configured for SW VAL 2 and SW VAL 3.</p> <p>ATTENTION <i>Other prompts affected: SW VALUE, SW VAL 2 and SW VAL 3.</i></p>

Function Prompt Lower Display	Selections or Range of Setting Upper Display	Parameter Definition
SW VAL12	Value in engineering units within PV or SP range limits	<p>AUTOMATIC SWITCHOVER VALUE—This is the value of Process Variable or Setpoint at which the controller will switch from Tuning Constant Set #1 to Set #2.</p> <p>ATTENTION Only appears when PID SETS selection is configured for 2 or 4 PID Sets.</p>
SW VAL23	Value in engineering units within PV or SP range limits	<p>AUTOMATIC SWITCHOVER VALUE—This is the value of Process Variable or Setpoint at which the controller will switch from Tuning Constant Set #2 to Set #3.</p> <p>ATTENTION Only appears when PID SETS selection is configured for 4 PID Sets.</p>
SW VAL34	Value in engineering units within PV or SP range limits	<p>AUTOMATIC SWITCHOVER VALUE—This is the value of Process Variable or Setpoint at which the controller will switch from Tuning Constant Set #3 to Set #4.</p> <p>ATTENTION Only appears when PID SETS selection is configured for 4 PID Sets.</p>
LSP'S	<p>1 ONLY</p> <p>TWO</p> <p>THREE</p> <p>FOUR</p>	<p>LOCAL SETPOINT SOURCE—This selection determines what your local setpoint source will be.</p> <p>LOCAL SETPOINT—The setpoint entered from the keyboard.</p> <p>TWO LOCAL SETPOINTS—This selection lets you switch between two local setpoints using the SP/Select key.</p> <p>THREE LOCAL SETPOINTS—This selection lets you switch between three local setpoints using the SP/Select key</p> <p>FOUR LOCAL SETPOINTS—This selection lets you switch between four local setpoints using the SP/Select key</p>
RSP SRC		<p>REMOTE SETPOINT SOURCE—This selection determines what your remote setpoint source will be when toggled by the SP/Select key or Digital Input.</p>

Function Prompt Lower Display	Selections or Range of Setting Upper Display	Parameter Definition
	NONE INPUT 1 INPUT 2 INPUT 3 INPUT 4 INPUT 5 IN ALG1 IN ALG2	<p>NONE—No remote setpoint. INPUT 1—Remote Setpoint using Input 1. INPUT 2—Remote Setpoint using Input 2. INPUT 3—Remote Setpoint using Input 3. INPUT 4—Remote Setpoint using Input 4. INPUT 5—Remote Setpoint using Input 5. IN AL1—Remote Setpoint using Input Algorithm 1. IN AL2—Remote Setpoint using Input Algorithm 2.</p> <p>ATTENTION To cycle through the available local setpoints and remote setpoint, press and hold in the SP/Select key. When the key is released, the setpoint selection currently displayed will be the new setpoint selection.</p>
AUTOBIAS	DISABLE ENABLE	<p>AUTOBIAS—Used for bumpless transfer when transferring from any local setpoint to remote setpoint. This makes the RSP equal to the CSP by adding, to the input used as the RSP source, a Bias value. It is changed each time a transfer is made. Available for any analog input used as the RSP source.</p> <p>DISABLE—Disables auto bias. ENABLE—Enables auto bias.</p>
SP TRACK	NONE PV RSP	<p>SETPOINT TRACKING—The local setpoint can be configured to track either PV or RSP as listed below.</p> <p>ATTENTION For selections other than NONE, LSP is stored in nonvolatile memory only when there is a mode change; i.e., when switching from RSP to LSP or from Manual to Automatic. If power is lost, then the current LSP value is also lost.</p> <p>NO TRACKING—If local setpoint tracking is not configured, the LSP will not be altered when transfer from RSP to LSP is made.</p> <p>PV—Local setpoint tracks the PV when in manual. RSP—Local setpoint is set equal to the remote setpoint when a change is made from using remote setpoint to any local setpoint.</p>
PWR MODE	MANUAL A LSP	<p>POWER UP CONTROLLER MODE RECALL—This selection determines which mode and setpoint the controller will use when the controller restarts after a power loss.</p> <p>MANUAL, LSP—At power-up, the controller will use manual mode with the local setpoint displayed. AUTOMATIC MODE, LAST LSP—At power-up, the controller will use automatic mode with the last local setpoint used before power down displayed.</p>

Function Prompt Lower Display	Selections or Range of Setting Upper Display	Parameter Definition
	A RSP AM SP AM LSP	AUTOMATIC MODE, LAST RSP —At power-up, the controller will use automatic mode with the last remote setpoint used before power down displayed. LAST MODE/LAST SETPOINT —At power-up, the controller will use the last mode and last Setpoint used before power down. LAST MODE/LAST LOCAL SETPOINT —At power-up, the controller will use the last mode and last Local Setpoint used before power down.
PWR OUT For Three Position Step Control Only (Note 3)	LAST F'SAFE	THREE POSITION CONTROL STEP OUTPUT START-UP MODE —This selection determines what position the motor will be in when powered up or in the failsafe position. LAST OUTPUT —At power-up in automatic mode, the motor position will be the last one prior to power down. When the unit goes into FAILSAFE, it will stay in automatic mode. The motor will not be driven to the configured failsafe position. FAILSAFE OUTPUT —At power-up in manual mode, the motor will be driven to either the 0 % or 100 % output position, whichever is selected at prompt FAILSAFE. For Burnout/None, when the unit goes into FAILSAFE, it will go to manual mode. The motor will be driven to the configured failsafe position.
SP HiLIM	NOTE 5	SETPOINT HIGH LIMIT * —This selection prevents the local and remote setpoints from going above the value selected here. The setting must be equal or less than the upper range of the inputs.
SP LoLIM	NOTE 5	SETPOINT LOW LIMIT * —This selection prevents the local and remote setpoints from going below the value selected here. The setting must be equal or greater than the lower range of the inputs.
* The local setpoint will automatically adjust itself to be within the setpoint limit range. For example, if SP = 1500 and SP HiLIM is changed to 1200, then the SP will be changed to 1200.		
ACTION	DIRECT REVERSE	CONTROL OUTPUT DIRECTION —Select direct or reverse output action. DIRECT ACTING CONTROL —The controller's output <i>increases</i> as the process variable increases. REVERSE ACTING CONTROL —The controller's output <i>decreases</i> as the process variable increases.

Function Prompt Lower Display	Selections or Range of Setting Upper Display	Parameter Definition
OUT RATE	ENABLE DISABLE	OUTPUT CHANGE RATE —Enables or disables the Output Change Rate. The maximum rate is set at prompt PCT/M UP or PCT/M DN. Only available for PID-A, PID-B, PD+MR control algorithms. ENABLE —Allows output rate. DISABLE —Disables output rate.
PCT/M UP	0 to 9999 % per minute	OUTPUT RATE UP VALUE —This selection limits the rate at which the output can change upward. Enter a value in percent per minute. Appears only if OUT RATE is enabled. “0” means no output rate applied.
PCT/M DN	0 to 9999 % per minute	OUTPUT RATE DOWN VALUE —This selection limits the rate at which the output can change downward. Enter a value in percent per minute. Appears only if OUT RATE is enabled. “0” means no output rate.
OUTHILIM	0 % to 100 % –5 % to 105 %	HIGH OUTPUT LIMIT —This is the highest value of output beyond which you do not want the controller automatic output to exceed. For relay output types. For current output types
OUTLoLIM	0 % to 100 % –5 % to 105 %	LOW OUTPUT LIMIT —This is the lowest value of output below which you do not want the controller automatic output to exceed. For relay output types. For current output types
I Hi LIM (Note 4)	Within the range of the output limits	HIGH RESET LIMIT —This is the highest value of output beyond which you do not want reset action to occur
I Lo LIM (Note 4)	Within the range of the output limits	LOW RESET LIMIT —This is the lowest value of output beyond which you do not want reset action to occur.
DROPOFF (Note 4)	–5 to 105 % of output	CONTROLLER DROPOFF VALUE —Output value below which the controller output will drop off to the low output limit value set in prompt OUTLoLIM.
DEADBAND	–5.0 to 25.0 % 0.0 to 25.0 % 0.5 to 5.0 %	DEADBAND —An adjustable gap between the operating ranges of output 1 and output 2 in which neither output operates (positive value) or both outputs operate (negative value). Time Duplex On-Off Duplex Position Proportional and Three Position Step

Function Prompt Lower Display	Selections or Range of Setting Upper Display	Parameter Definition
OUT HYST	0.0 to 100.0 % of PV span	HYSTERESIS (OUTPUT RELAY) is an adjustable overlap of the ON/OFF states of each control output. This is the difference between the value of the process variable at which the control outputs energize and the value at which they de-energize. Only applicable for ON/OFF control.
FAILMODE	NoLATCH LATCH	FAILSAFE MODE NON-LATCHING —Controller stays in last mode that was being used (automatic or manual); If unit was in Automatic mode, then the output goes to the failsafe value. (NOTE 1, NOTE 2) LATCHING —Controller goes to manual mode; If unit was in Automatic mode, then the output goes to the failsafe value. (NOTE 2)
FAILSAFE	0 to 100 %	FAILSAFE OUTPUT VALUE —The value used here will also be the output level when you have Communications SHED set to failsafe or when NO BURNOUT is configured and the PV Source fails. ATTENTION Applies for all output types <i>except</i> Three Position Step Control.
	0 PCT 100 PCT	THREE POSITION STEP FAILSAFE OUTPUT 0 PCT —Motor goes to closed position. 100 PCT —Motor goes to open position.
SW FAIL	0 PCT 100 PCT	Position Proportional motor position when slidewire fails. 0 PCT —Motor goes to closed position. 100 PCT —Motor goes to open position. ATTENTION PWR OUT must be configured for FSAFE.
MAN OUT	0 to 100 %	POWER-UP PRESET MANUAL OUTPUT —At power-up, the controller will go to manual and the output to the value set here. (NOTE 1)
AUTO OUT	0 to 100 %	POWER-UP PRESET AUTOMATIC OUTPUT —At power-up, the controller will begin its automatic control at the output value set here. (NOTE 1)
PBorGAIN (selection is used for both loops)		PROPORTIONAL BAND UNITS —Select one of the following for the Proportional (P) term of the PID algorithm:

Function Prompt Lower Display	Selections or Range of Setting Upper Display	Parameter Definition
	PB PCT GAIN	<p>PROPORTIONAL BAND selects units of percent proportional band for the P term of the PID algorithm. Where: $PB \% = \frac{100 \% FS}{GAIN}$</p> <p>GAIN selects the unitless term of gain for the P term of the PID algorithm. Where: $GAIN = \frac{100 \% FS}{PB\%}$</p>
<p>MINUTESorRPM (selection is used for both loops)</p>	RPM MINUTES	<p>RESET UNITS—Selects units of minutes per repeat or repeats per minute for the “I” term of the PID algorithm. 20 Repeats per Minute = 0.05 Minutes per Repeat.</p> <p>REPEATS PER MINUTE—The number of times per minute that the proportional action is repeated by reset.</p> <p>MINUTES PER REPEAT—The time between each repeat of the proportional action by reset.</p>
<p>NOTE 1: Does not apply to Three Position Step Control.</p> <p>NOTE 2: If controller is in Manual mode when a failure occurs, then the output will maintain its value.</p> <p>NOTE 3: These selections appear when: A) Control Algorithm is selected for 3PSTEP. B) Control Algorithm is selected for PD+MR and Output Algorithm is selected for Position Proportional.</p> <p>NOTE 4: Reset limits and Dropoff are not displayed when Three Position Step Control is configured.</p> <p>NOTE 5: If PV source is one of the Analog Inputs, then the SP HiLIM and SP LoLIM values must be between the Input High and Input Low values for the input type configured. If the PV source is an Input Algorithm configured for:</p> <ul style="list-style-type: none"> • Carbon Potential; then the SP HiLIM and SP LoLIM values must be between 0.000 and 2.000 • Dewpoint; then the SP HiLIM and SP LoLIM values must be between –50 and +100 • Oxygen; then the SP HiLIM and SP LoLIM values must be between 0 to 40.00 • Weighted Average, Summer, Subtractor, High or Low; then the SP HiLIM and SP LoLIM values must be between the configured CALC HI and CALC LOW values. CALC HI and CALC LOW can be set anywhere between –999 and 9999. • Math A, Math B, Math C or Math D; then the SP HiLIM and SP LoLIM values can be set anywhere between –999 and 9999 and are not limited to the CALC HI and CALC LOW values 		

3.21 Control 2 Set Up Group

Introduction



The functions listed in this group deal with how the controller will control the Loop 2 process including: Number of Tuning Parameter Sets, Setpoint Source, Tracking, Power-up Recall, Setpoint Limits, Output Direction and Limits, Deadband, and Hysteresis.

Function Prompts

Table 3-21 CONTROL2 Group Function Prompts

Function Prompt Lower Display	Selections or Range of Setting Upper Display	Parameter Definition
PV 2 SRC	INPUT 1 INPUT 2 INPUT 3 INPUT 4 INPUT 5 IN ALG1 IN ALG2	PROCESS VARIABLE SOURCE —Selects the source of the Process Variable for Loop 2. INPUT 1 INPUT 2 INPUT 3 INPUT 4 INPUT 5 INPUT ALGORITHM 1 INPUT ALGORITHM 2
LINK LPS	DISABLE AUTOMAN SP1 AM+SP1	LINK LOOPS MODE AND SETPOINT —Link together the operation of the two loops. If either loop changes mode due to a front panel change, digital input action, or failsafe action, then the other loop will track that mode and/or local setpoint. DISABLE —Disable. Loops operate independently. LINK MODES —Links A/M modes on both loops. LINK LSP1 —Links Local Setpoint 1 for both loops. LINK MODES AND SETPOINTS —Links both modes and Local Setpoint 1 for both loops.
PID SETS	1 ONLY 2KEYBD	NUMBER OF TUNING PARAMETER SETS —This selection lets you choose one or two sets of tuning constants (gain, rate, and reset). ONE SET ONLY —Only one set of tuning parameters is available. Configure the values for: Gain (proportional band) Rate Reset Time Cycle Time (if time proportional is used) TWO SETS KEYBOARD SELECTABLE —Two sets of tuning parameters can be configured and can be selected at the operator interface or by using the Digital Inputs. Press Lower/Display key until you see PID SET3 or PID SET4 then press or ▼ to switch between

Function Prompt Lower Display	Selections or Range of Setting Upper Display	Parameter Definition
	<p>2PV SW</p> <p>2SP SW</p> <p>4SP SW</p>	<p>sets. Configure the values for: Gain #3, Rate #3 , Reset #3, Cycle #3 Time Gain #4, Rate #4, Reset #4, Cycle #4 Time</p> <p>TWO SETS PV AUTOMATIC SWITCHOVER— When the process variable is <i>GREATER</i> than the value set at prompt SW VALUE (Switchover Value), the controller will use Gain #3, Rate #3, Reset #3, and Cycle #3 Time. The active PID SET can be read in the lower display.</p> <p>When the process variable is <i>LESS</i> than the value set at prompt SW VALUE, the controller will use Gain #4, Rate #4, Reset #4, and Cycle #4 Time. The active PID SET can be read in the lower display.</p> <p><i>Other prompts affected: SW VALUE</i></p> <p>TWO SETS SP AUTOMATIC SWITCHOVER— When the setpoint is <i>GREATER</i> than the value set at prompt SW VALUE (Switchover Value), the controller will use Gain #3, Rate #3, Reset #3, and Cycle #3.</p> <p>When the setpoint is <i>LESS</i> than the value set at prompt SW VALUE, the controller will use Gain #4, Rate #4, Reset #4, and Cycle #4.</p> <p><i>Other prompts affected: SW VALUE</i></p> <p>FOUR SETS SP AUTOMATIC SWITCHOVER— When the setpoint is <i>GREATER</i> than the value set at prompt SW VALUE (Switchover Value), the controller will use Gain, Rate, Reset, and Cycle.</p> <p>When the setpoint is <i>LESS</i> than the value set at prompt SW VALUE, the controller will use Gain #2, Rate #2, Reset #2, and Cycle #2.</p> <p>Similarly, the controller switches between the other PID sets based upon the values configured for SW VAL 2 and SW VAL 3.</p> <p>ATTENTION <i>Other prompts affected: SW VALUE, SW VAL 2 and SW VAL 3.</i></p>

Function Prompt Lower Display	Selections or Range of Setting Upper Display	Parameter Definition
	4KEYBD	<p>FOUR SETS KEYBOARD SELECTABLE—Two sets of tuning parameters can be configured and can be selected at the operator interface or by using the Digital Inputs.</p> <p>Press the Lower/Display key until you see PID SET1 or PID SET2 or PID SET3 or PID SET4 then press  or  to switch between the sets.</p> <p>Configure the values for: Gain, Rate, Reset, Cycle Time Gain #2, Rate #2, Reset #2, Cycle #2 Time Gain #3, Rate #3, Reset #3, Cycle #3 Time Gain #4, Rate #4, Reset #4, Cycle #4 Time</p>
	4PV SW	<p>FOUR SETS PV AUTOMATIC SWITCHOVER—When the process variable is <i>GREATER</i> than the value set at prompt SW VALUE (Switchover Value), the controller will use Gain, Rate, Reset, and Cycle Time. The active PID SET can be read in the lower display.</p> <p>When the process variable is <i>LESS</i> than the value set at prompt SW VALUE, the controller will use Gain #2, Rate #2, Reset #2, and Cycle #2 Time. The active PID SET can be read in the lower display.</p> <p>Similarly, the controller switches between the other PID sets based upon the values configured for SW VAL 2 and SW VAL 3.</p> <p>ATTENTION <i>Other prompts affected: SW VALUE, SW VAL 2 and SW VAL 3.</i></p>
	4SP SW	<p>FOUR SETS SP AUTOMATIC SWITCHOVER—When the setpoint is <i>GREATER</i> than the value set at prompt SW VALUE (Switchover Value), the controller will use Gain, Rate, Reset, and Cycle.</p> <p>When the setpoint is <i>LESS</i> than the value set at prompt SW VALUE, the controller will use Gain #2, Rate #2, Reset #2, and Cycle #2.</p> <p>Similarly, the controller switches between the other PID sets based upon the values configured for SW VAL 2 and SW VAL 3.</p> <p>ATTENTION <i>Other prompts affected: SW VALUE, SW VAL 2 and SW VAL 3.</i></p>

Function Prompt Lower Display	Selections or Range of Setting Upper Display	Parameter Definition
SW VAL12	Value in engineering units within PV or SP range limits	<p>AUTOMATIC SWITCHOVER VALUE—This is the value of Process Variable or Setpoint at which the controller will switch from Tuning Constant Set #1 to Set #2.</p> <p>ATTENTION Only appears when PID SETS selection is configured for 2 or 4 PID Sets.</p>
SW VAL23	Value in engineering units within PV or SP range limits	<p>AUTOMATIC SWITCHOVER VALUE—This is the value of Process Variable or Setpoint at which the controller will switch from Tuning Constant Set #2 to Set #3.</p> <p>ATTENTION Only appears when PID SETS selection is configured for 4 PID Sets.</p>
SW VAL34	Value in engineering units within PV or SP range limits	<p>AUTOMATIC SWITCHOVER VALUE—This is the value of Process Variable or Setpoint at which the controller will switch from Tuning Constant Set #3 to Set #4.</p> <p>ATTENTION Only appears when PID SETS selection is configured for 4 PID Sets.</p>
LSP'S	1 ONLY TWO THREE FOUR	<p>LOCAL SETPOINT SOURCE—This selection determines what your local setpoint source will be.</p> <p>LOCAL SETPOINT—The setpoint entered from the keyboard.</p> <p>TWO LOCAL SETPOINTS—This selection lets you switch between two local setpoints using the SP/Select key.</p> <p>THREE LOCAL SETPOINTS—This selection lets you switch between three local setpoints using the SP/Select key.</p> <p>FOUR LOCAL SETPOINTS—This selection lets you switch between three local setpoints using the SP/Select key.</p>
RSP SRC	NONE INPUT 1 INPUT 2 INPUT 3 INPUT 4 INPUT 5 IN AL1	<p>REMOTE SETPOINT SOURCE—This selection determines what your remote setpoint source will be when toggled by the SP/Select key or Digital Input.</p> <p>NONE—No remote setpoint.</p> <p>INPUT 1—Remote Setpoint using Input 1.</p> <p>INPUT 2—Remote Setpoint using Input 2.</p> <p>INPUT 3—Remote Setpoint using Input 3.</p> <p>INPUT 4—Remote Setpoint using Input 4.</p> <p>INPUT 5—Remote Setpoint using Input 5.</p> <p>INPUT ALGORITHM 1—Remote Setpoint using Input Algorithm 1.</p> <p>INPUT ALGORITHM 2—Remote Setpoint using Input Algorithm 2.</p>

Function Prompt Lower Display	Selections or Range of Setting Upper Display	Parameter Definition
	IN AL2	<p>ATTENTION To cycle through the available local setpoints and remote setpoint, press and hold in the SP/Select key. When the key is released, the setpoint selection currently displayed will be the new setpoint selection.</p>
AUTOBIAS	ENABLE DISABLE	<p>AUTO BIAS—Used for bumpless transfer when transferring from local setpoint to remote setpoint. Auto Bias calculates and adds a bias to remote setpoint input each time a transfer is made. Available for any analog input used as the RSP source and if no tracking is selected.</p> <p>ENABLE—Enables auto bias. DISABLE—Disables auto bias.</p>
SPTRACK	NONE PV RSP	<p>SETPOINT TRACKING—The local setpoint can be configured to track either PV or RSP as listed below. Not configurable when Auto Bias is set.</p> <p>ATTENTION For selections other than NONE, LSP is stored in nonvolatile memory only when there is a mode change; i.e., when switching from RSP to LSP or from Manual to Automatic. If power is lost, then the current LSP value is also lost.</p> <p>NO TRACKING—If local setpoint tracking is not configured, the LSP will not be altered when transfer from RSP to LSP is made.</p> <p>PV—Local setpoint tracks the PV when in manual mode.</p> <p>RSP—Local setpoint tracks remote setpoint. When the controller transfers out of remote setpoint, the last value of the remote setpoint (RSP) is inserted into the local setpoint.</p>
PWR MODE	MANUAL A LSP A RSP	<p>POWER UP CONTROLLER MODE RECALL—This selection determines which mode and setpoint the controller will use for Loop 2 when the controller restarts after a power loss.</p> <p>MANUAL, LSP—At power-up, the controller will use manual mode with the local setpoint displayed.</p> <p>AUTOMATIC MODE, LAST LSP—At power-up, the controller will use automatic mode with the last Local Setpoint used before power down displayed.</p> <p>AUTOMATIC MODE, LAST RSP—At power-up, the controller will use automatic mode with the last Remote Setpoint used before power down displayed.</p>

Function Prompt Lower Display	Selections or Range of Setting Upper Display	Parameter Definition
	AM SP AM LSP	LAST MODE/LAST SETPOINT —At power-up, the controller will use the last mode and last Setpoint used before power down. LAST MODE/LAST LOCAL SETPOINT —At power-up, the controller will use the last mode and last Local Setpoint used before power down.
SP HiLIM	NOTE 1	SETPOINT HIGH LIMIT * —This selection prevents the local and remote setpoints from going above the value selected here. The setting must be equal or less than the upper range of the inputs.
SP LoLIM	NOTE 1	SETPOINT LOW LIMIT * —This selection prevents the local and remote setpoints from going below the value selected here. The setting must be equal or greater than the lower range of the inputs.
* The local setpoint will automatically adjust itself to be within the setpoint limit range. For example, if SP = 1500 and SP HiLIM is changed to 1200, then the SP will be changed to 1200.		
ACTION	DIRECT REVRSE	CONTROL OUTPUT DIRECTION —Select direct or reverse acting control. DIRECT ACTING CONTROL —The controller's output <i>increases</i> as the process variable increases. REVERSE ACTING CONTROL —The controller's output <i>decreases</i> as the process variable increases.
OUT RATE	DISABLE ENABLE	OUTPUT CHANGE RATE —Enables or disables the Output Change Rate. The maximum rate is set at prompt PCT/M UP or PCT/M DN. DISABLE —Disables output rate. ENABLE —Allows output rate.
PCT/M UP	0 to 9999 % per minute	OUTPUT RATE UP VALUE —This selection limits the rate at which the output can change upward. Enter a value in percent per minute. Appears only if OUT RATE is enabled. "0" means no output rate applied.
PCT/M DN	0 to 9999 % per minute	OUTPUT RATE DOWN VALUE —This selection limits the rate at which the output can change downward. Enter a value in percent per minute. Appears only if OUT RATE is enabled. "0" means no output rate.
OUTHILIM	0 % to 100 % -5 % to 105 %	HIGH OUTPUT LIMIT —This is the highest value of output beyond which you do not want the controller automatic output to exceed. For relay output types. For current output types

Function Prompt Lower Display	Selections or Range of Setting Upper Display	Parameter Definition
OUTLoLIM	0 % to 100 % -5 % to 105 %	LOW OUTPUT LIMIT —This is the lowest value of output below which you do not want the controller automatic output to exceed. For relay output types. For current output types
I Hi LIM	Within the range of the output limits	HIGH RESET LIMIT —This is the highest value of output beyond which you want no reset to occur.
I Lo LIM	Within the range of the output limits	LOW RESET LIMIT —This is the lowest value of output beyond which you want no reset to occur.
DROPOFF	-5 to 105 % of output	CONTROLLER DROPOFF VALUE —Output value below which the controller output will drop off to the low output limit value set in prompt OUTLoLIM.
DEADBAND	-5.0 to 25.0 %	DEADBAND —An adjustable gap between the operating ranges of output 1 and output 2 in which neither output operates (positive value) or both outputs operate (negative value). Time Duplex
FAILMODE	NoLATCH LATCH	FAILSAFE MODE —How the controller operates during a Failsafe condition. NON-LATCHING —Controller stays in last mode (automatic or manual); output goes to failsafe value. LATCHING —Controller goes to manual mode; output goes to failsafe value.
FAILSAFE	0 to 100 %	FAILSAFE OUTPUT 2 VALUE —The value used here will also be the output level when you have Communications SHED set to failsafe or when NO BURNOUT is configured and the PV Source fails. ATTENTION At power-up, the Loop 2 Output is set to the Failsafe Output 2 value.

NOTE 1: If PV source is one of the Analog Inputs, then the SP HiLIM and SP LoLIM values must be between the Input High and Input Low values for the input type configured. If the PV source is an Input Algorithm configured for:

- Carbon Potential, then the SP HiLIM and SP LoLIM values must be between 0.000 and 2.000
- Dewpoint, then the SP HiLIM and SP LoLIM values must be between -50 and +100
- Oxygen, then the SP HiLIM and SP LoLIM values must be between 0 to 40.00
- Weighted Average, Summer, Subtractor, High or Low, then the SP HiLIM and SP LoLIM values must be between the configured CALC HI and CALC LOW values. CALC HI and CALC LOW can be set anywhere between -999 and 9999.
- Math A, Math B, Math C or Math D, then the SP HiLIM and SP LoLIM values can be set anywhere between -999 and 9999 and are not limited to the CALC HI and CALC LOW values.

3.22 Options Set Up Group

Introduction

The Options group lets you configure the remote mode switch (Digital Inputs) to a specific contact closure response, or configure Second Current Output or Third Current Output to be a specific selection with desired scaling.

The UDC3500 has three current outputs, two of which are configured in this Set Up Group.

The UDC3500 has four digital inputs. Loop assignments are made in this Set Up Group.

Function Prompts

Table 3-22 OPTION Group Function Prompts

Function Prompt Lower Display	Selections or Range of Setting Upper Display	Parameter Definition
<p>CUR OUT2</p> <p>ATTENTION Prompts for the Second Current Output Selection appear only if the Second Current Output option is installed.</p>	<p>DISABLE</p> <p>INPUT 1</p> <p>INPUT 2</p>	<p>SECOND CURRENT OUTPUT SELECTION</p> <p>This selection provides a milliamp output representing one of several control parameters. The display for the Second Current Output viewing will be in engineering units for all but output. Output will be displayed in percent.</p> <p>ATTENTION Other prompts affected by these selections: 4mA VAL and 20mA VAL.</p> <p>ATTENTION OUTPUT cannot be configured when Three Position Step Control is used.</p> <p>ATTENTION When Loop 2 Output is configured for CURRENT and there is no Third Current Output option installed, the Second Current Output is forced to "OUTPUT 2".</p> <p>NO SECOND CURRENT OUTPUT—Current Output disabled and output set to 0 mA.</p> <p>INPUT 1—This represents the configured range of Input 1.</p> <p>FOR EXAMPLE: Input 1 Type = J Thermocouple (0 °F to 1600 °F) Second Current Output Low Scale Value = 0.0 Second Current Output High Scale Value = 1600 CO Range = 4-20 mA</p> <p>Then: 0 °F display = 0 % output (4 mA) 800 °F display = 50 % output (12 mA) 1600 °F display = 100 % output (20 mA)</p> <p>INPUT 2—Same as Input 1</p>

Function Prompt Lower Display	Selections or Range of Setting Upper Display	Parameter Definition
	<p>INPUT 3</p> <p>INPUT 4</p> <p>INPUT 5</p> <p>CB OUT</p> <p>PV</p> <p>DEV</p>	<p>INPUT 3—Same as Input 1</p> <p>ATTENTION Do not configure Input 3 when Input 3 is used for Slidewire or Slidewire emulation.</p> <p>INPUT 4—Same as Input 1</p> <p>INPUT 5—Same as Input 1</p> <p>CONTROL BLOCK OUTPUT—Output as calculated by the control block (such as PID A). When using one of the characterizers, OUTPUT is the output value after it passes through the characterizer. CB OUT is the control block output before it passes through the characterizer.</p> <p>ATTENTION CB OUT should not be used for Three Position Step Control or Position Proportional Control applications.</p> <p>PROCESS VARIABLE—Represents the value of the Process Variable.</p> <p>DEVIATION (PROCESS VARIABLE MINUS SETPOINT)—Represents –100 % to +100 % of the selected PV span in engineering units.</p> <p>Zero deviation will produce a center scale (12 mA or 50 %) output. A negative deviation equal in magnitude to the Output High Scaling Factor will produce a low end output (4 mA or 0 %) output. A positive deviation equal in magnitude to the Output High Scaling Factor will produce a high end output (20 mA or 100 %).</p> <p>FOR EXAMPLE: Configuration is as follows: Input 1 = Type T High Thermocouple PV range = –300 °F to +700 °F PV span = 1000 °F Deviation Range = –1000 to +1000 °F = 2000 °F Second Current Output Low Scale Value = 0.0 Second Current Output High Scale Value = 1000 CO Range = 4-20 mA</p> <p>If PV = 500 °F and SP = 650 °F then Deviation Display = –150 °F, which is $-150 / 2000 = -7.5\%$ of the Deviation Range, so Second Current Output = $50\% - 7.5\% = 42.5\%$ which is $0.425 \times 16 \text{ mA} + 4 \text{ mA} = 10.8 \text{ mA}$</p>

Function Prompt Lower Display	Selections or Range of Setting Upper Display	Parameter Definition
	OUTPUT	<p>OUTPUT—Represents the displayed controller output in percent (%).</p> <p>ATTENTION Also see CB OUT when using a characterizer on the output value.</p> <p>ATTENTION When Position Proportional Control is configured as the Output Algorithm, OUTPUT represents the actual Slidewire Position whether in Automatic or Manual Mode. Should the Slidewire input fail for any reason, the Auxiliary Output will go to the value configured for FAILSAFE OUTPUT VALUE in the Control Setup Group.</p> <p>ATTENTION When Three Position Step Control (TPSC) is configured as the Control Algorithm, OUTPUT represents only the estimated motor position, not the actual motor position.</p>
	SP	<p>SETPOINT—Represents the value of the setpoint currently in use (LSP1, LSP2, LSP3, RSP or CSP) and is shown in the same units as those used by the PV.</p>
	LSP 1	<p>LOCAL SETPOINT ONE—Output represents Local Setpoint 1 regardless of active setpoint.</p>
	RSP	<p>REMOTE SETPOINT—Represents the configured RSP regardless of the active SetPoint.</p>
	IN ALG1	<p>INPUT ALGORITHM 1 OUTPUT—Represents the output from input algorithm 1.</p>
	IN ALG2	<p>INPUT ALGORITHM 2 OUTPUT—Represents the output from input algorithm 2.</p>
	PV 2	<p>PROCESS VARIABLE FOR LOOP 2—Represents the value of the Process Variable for Loop 2.</p>
	CBOU2L2	<p>CONTROL BLOCK OUTPUT FOR LOOP 2—Output for Loop 2 as calculated by the control block (such as PID A). When using one of the characterizers, OUTPUT 2 is the output value for Loop 2 after it passes through the characterizer. CB OUTL2 is the control block output before it passes through the characterizer.</p>

Function Prompt Lower Display	Selections or Range of Setting Upper Display	Parameter Definition
	DEV 2	<p>DEVIATION (PROCESS VARIABLE MINUS SETPOINT FOR LOOP 2)—Represents –100 % to +100 % of the selected PV span in engineering units.</p> <p>Zero deviation will produce a center scale (12 mA or 50 %) output. A negative deviation equal in magnitude to the Output High Scaling Factor will produce a low-end output (4mA or 0 %) output. A positive deviation equal in magnitude to the Output High Scaling Factor will produce a high-end output (20 mA or 100 %).</p> <p>FOR EXAMPLE: Configuration is as follows: Input 1 = Type T High Thermocouple PV range = –300 °F to +700 °F PV span = 1000 °F Deviation Range = –1000 to +1000 °F = 2000 °F Second Current Output Low Scale Value = 0.0 Second Current Output High Scale Value = 1000 C2 Range = 4-20 mA</p> <p>If PV = 500 °F and SP = 650 °F then Deviation Display = –150 °F, which is $-150 / 2000 = -7.5\%$ of the Deviation Range, so</p> <p>Second Current Output = 50% – 7.5% = 42.5% which is $0.425 \times 16 \text{ mA} + 4 \text{ mA} = 10.8 \text{ Ma}$</p>
	OUTPUT 2	<p>OUTPUT FOR LOOP 2—Represents the displayed controller Loop 2 output in percent (%).</p> <p>ATTENTION Also see CBOU2L2 when using a characterizer on the Loop 2 output value.</p>
	SP LP2	<p>SETPOINT FOR LOOP 2—Represents the value of the setpoint currently in use by Loop 2 (LSP1, LSP2, LSP3, RSP or CSP) and is shown in the same units as those used by the PV for Loop 2.</p>
	LSP1LP2	<p>LOCAL SETPOINT ONE FOR LOOP 2—Output represents Loop 2 Local Setpoint 1 regardless of active setpoint.</p>
	RSP LP2	<p>REMOTE SETPOINT FOR LOOP 2—Represents the configured Loop 2 RSP regardless of the active SetPoint for Loop 2.</p>

Function Prompt Lower Display	Selections or Range of Setting Upper Display	Parameter Definition
C2 RANGE	4-20mA 0-20mA	<p>SECOND CURRENT OUTPUT RANGE—Allows the user to easily select 4-20mA output or 0-20mA output operation without the need for recalibration of the instrument.</p> <p>ATTENTION Changing the Current Output Range will result in the loss of Field Calibration values and will restore Factory Calibration values.</p>
LOW VAL	Low Scale Value within the range of the selected variable to represent the minimum output (0 or 4 mA)	<p>OUTPUT LOW SCALING FACTOR—This is a value in engineering units used to represent all configured parameters except Output.</p> <p>For Output, this is a value in percent and can be any value between –5 % and +105 %. However, keep in mind that relay output types can only be scaled 0 % to 100 %.</p>
HIGH VAL	High Scale Value within the range of the selected variable to represent the maximum output (20 mA)	<p>OUTPUT HIGH SCALING FACTOR—This is a value in engineering units used to represent all configured parameters except Output.</p> <p>For Output, this is a value in percent and can be any value between –5 % and +105 %. However, keep in mind that relay output types can only be scaled 0 % to 100 %.</p>
<p>CUR OUT3</p> <p>ATTENTION Prompts for the Third Current Output Selection appear only when the Third Current Output option is installed.</p>	Same selections as for CUR OUT2	<p>THIRD CURRENT OUTPUT SELECTION—Provides a milliamp output representing one of several control parameters. The display for Third Current Output viewing will be in engineering units for all but output. Output will be displayed in percent.</p> <p>ATTENTION Other prompts affected by these selections: 4mA VAL and 20mA VAL.</p> <p>ATTENTION When Loop 2 Output is configured for CURRENT, the Third Current Output is forced to “OUTPUT 2”.</p> <p>ATTENTION CB OUT should not be used for Three Position Step Control or Position Proportional Control applications.</p>
C3 RANGE	4-20mA 0-20mA	<p>THIRD CURRENT OUTPUT RANGE—Allows the user to easily select 4-20mA output or 0-20mA output operation without the need for recalibration of the instrument.</p> <p>ATTENTION Changing the Current Output Range will result in the loss of Field Calibration values and will restore Factory Calibration values.</p>

Function Prompt Lower Display	Selections or Range of Setting Upper Display	Parameter Definition
LOW VAL	Low Scale Value within the range of the selected variable to represent the minimum output (0 or 4 mA)	<p>OUTPUT LOW SCALING FACTOR—This is a value in engineering units used to represent all configured parameters except Output.</p> <p>For Output, this is a value in percent and can be any value between –5 % and +105 %. However, keep in mind that relay output types can only be scaled 0 % to 100 %.</p>
HIGH VAL	High Scale Value within the range of the selected variable to represent the maximum output (20 mA)	<p>OUTPUT HIGH SCALING FACTOR—This is a value in engineering units used to represent all configured parameters except Output.</p> <p>For Output, this is a value in percent and can be any value between –5 % and +105 %. However, keep in mind that relay output types can only be scaled 0 % to 100 %.</p>
DIG INP1	<p>NONE</p> <p>TO MAN</p> <p>TO LSP</p> <p>TO 2SP</p> <p>TO 3SP</p> <p>TO 4SP</p> <p>TO DIR</p>	<p>DIGITAL INPUT 1 SELECTIONS—All selections are available for Input 1. The controller returns to its original state when contact opens, except where noted or when overruled by the keyboard.</p> <p>NO DIGITAL INPUT SELECTION</p> <p>TO MANUAL—Contact closure puts the affected loop into manual mode. Contact open returns controller to former mode.</p> <p>TO LOCAL SETPOINT—When a remote setpoint is configured, contact closure puts the controller into local setpoint 1. When contact opens, the controller returns to former operation—local or remote setpoint—unless the SP/Select key is pressed while digital input is active. If this happens, the controller will stay in the local setpoint mode when contact opens.</p> <p>TO LOCAL SETPOINT TWO—Contact closure puts the controller into local setpoint 2.</p> <p>TO LOCAL SETPOINT THREE—Contact closure puts the controller into local setpoint 3.</p> <p>TO LOCAL SETPOINT FOUR—Contact closure puts the controller into local setpoint 4.</p> <p>TO DIRECT ACTION—Contact closure selects direct controller action.</p>

Function Prompt Lower Display	Selections or Range of Setting Upper Display	Parameter Definition
	TO HOLD	<p>TO HOLD—Contact closure suspends Setpoint Program or Setpoint Ramp. When contact reopens, the controller starts from the Hold point of the Ramp/Program unless the Ramp/Program was not previously started via the Run/Hold key.</p> <p>This selection applies to either loop.</p> <p>ATTENTION When multiple SP Programs are enabled, this configuration is affected by the “SPP A” and “SPP B” configurations below.</p>
	TO PID2	<p>TO PID2—Contact closure selects PID Set 2.</p>
	TO PID3	<p>TO PID3—Contact closure selects PID Set 3.</p>
	TO PID4	<p>TO PID4—Contact closure selects PID Set 4.</p>
	PV 2IN	<p>PV=INPUT 2—Contact closure selects PV = Input 2.</p>
	PV 3IN	<p>PV=INPUT 3—Contact closure selects PV = Input 3.</p>
	RERUN	<p>RERUN—Allows the Setpoint Programmer to be reset to the initial segment of its current cycle, unit stays in previous mode.</p> <p>ATTENTION When multiple SP Programs are enabled, this configuration is affected by the “SPP A” and “SPP B” configurations below.</p>
	TO RUN	<p>RUN—Contact closure starts a stopped SP Ramp or Program. Upper left character blinks “R”. Reopening the contact has no effect.</p> <p>This selection applies to either loop.</p> <p>ATTENTION When multiple SP Programs are enabled, this configuration is affected by the “SPP A” and “SPP B” configurations below.</p>

Function Prompt Lower Display	Selections or Range of Setting Upper Display	Parameter Definition
	ToBEGIN	<p>EXTERNAL SP PROGRAM RESET—Contact closure resets SP Program back to the beginning of the first segment in the program and places the program in the HOLD mode. Program cycle number is reset to the configured value. Reopening switch has no effect.</p> <p>This selection applies to either loop.</p> <p>ATTENTION Once the last segment of the setpoint program has timed out, the controller enters the mode of action specified in the configuration data and the program cannot be reset to the beginning of the first segment by digital input closure if the program is disabled.</p> <p>ATTENTION When multiple SP Programs are enabled, this configuration is affected by the “PROG LO” and “PROG HI” configurations below.</p>
	STOP I	<p>INHIBIT INTEGRAL (RESET)—Contact closure disables PID Integral (Reset) action.</p>
	MAN FS	<p>MANUAL FAILSAFE OUTPUT—Controller goes to Manual mode, output goes to the Failsafe value.</p>
		<p>ATTENTION This will cause a bump in the output when switching from Automatic to Manual. The switch back from Manual to Automatic is bumpless. When the switch is closed, the output can be adjusted from the keyboard.</p>
	TO LOCK	<p>KEYBOARD LOCKOUT—Contact closure disables all keys. Lower display shows LOCKED if a key is pressed.</p>
	TO Aout	<p>AUTOMATIC OUTPUT—Contact closure sends output to the value set at the prompt AUTO OUT in the Control (Loop 1) Set Up Group when the controller is in the Automatic mode. Reopening the contact returns the controller to its normal output. Digital Inputs assigned to Loop 2 will also use the AUTO OUT value in the Control Setup Group.</p>
		<p>ATTENTION Does not apply to Three Position Step Control.</p>
	TIMER	<p>TIMER—Contact closure starts timer, if enabled. Reopening the switch has no effect.</p>

Function Prompt Lower Display	Selections or Range of Setting Upper Display	Parameter Definition
	AM STA	TO AUTO/MANUAL STATION —Contact closure causes the control loop to perform as follows: PV = Input 2 Action = Direct Control algorithm = PD+MR PID SET = 2 SP = LSP 2
	TO TUNE	INITIATE LIMIT CYCLE TUNING —Contact closure starts the tuning process. The lower display shows TUNE ON. Opening the contact has no effect.
	SP Init	SETPOINT INITIALIZATION —Contact closure forces the setpoint to the current PV value. Opening the contact has no effect.
	TRACK 1	OUTPUT 1 TRACKS INPUT 2 —Contact closure allows Output to track Input 2. While the switch is open, the output is in accordance with its pre-defined functionality. When the switch is closed, the output value (in percent) will track the Input 2 percent of range value. When the switch is reopened, the output will start at this last output value and normal PID action will then take over control. The transfer is bumpless.
	TRACK 2	OUTPUT 2 TRACKS INPUT 2 —Contact closure allows Output 2 to track Input 2. While the switch is open, the output is in accordance with its pre-defined functionality. When the switch is closed, the output value (in percent) will track the Input 2 percent of range value. When the switch is reopened, the output will start at this last output value and normal PID action will then take over control. The transfer is bumpless.
	To OUT2	OUTPUT 2 OVERRIDES OUTPUT 1 —Contact closure forces Output 1 to track Output 2. Opening the contact restores normal operation.
		ATTENTION Does not apply to Three Position Step Control.
	TO RSP	TO REMOTE SETPOINT —Contact closure selects the Remote setpoint.
	D L1/2	LOOP DISPLAY —Contact closure displays the loop not currently being displayed. Opening contact returns to the original loop display.
	RST FB	EXTERNAL RESET FEEDBACK —Contact closure allows Input 2 to override the internal reset value.

Function Prompt Lower Display	Selections or Range of Setting Upper Display	Parameter Definition
	<p>To PURGE</p> <p>PURG AX</p> <p>Lo FIRE</p> <p>MAN LAT</p> <p>RES TOT</p> <p>PV HOLD</p>	<p>TO PURGE—Contact closure forces the loop to Manual mode with the output set to the Output High Limit configuration. MAN lights and then the Output value is shown on the lower display. Opening the switch has no effect.</p> <p>Pressing the Man/Auto key returns the instrument to Automatic Mode.</p> <p>ATTENTION Does not apply to Three Position Step Control.</p> <p>PURGE AUXILIARY OUTPUT—When the switch is closed, any Auxiliary Output configured for OUTPUT will go to 100% (20 mA). When switch reopens, the Auxiliary Output resumes normal operation.</p> <p>LOW FIRE—Contact closure forces the loop to Manual mode with the output set to the Output Low Limit configuration. MAN lights and the Output value is shown on the lower display. Opening the switch has no effect.</p> <p>Pressing the Man/Auto key returns the instrument to Automatic Mode.</p> <p>ATTENTION Does not apply to Three Position Step Control.</p> <p>MANUAL LATCHING—Contact closure transition forces the loop to Manual mode. Opening the switch has no effect. If the Man/Auto key is pressed while the switch is closed, the loop will return to Automatic mode.</p> <p>RESET TOTALIZER—Contact closure transition resets the accumulated Totalizer value to zero. Opening the switch has no effect.</p> <p>PROCESS VARIABLE HOLD—When the switch is closed, PV is frozen at last value. When switch opens, PV resumes normal operation after 2 seconds.</p>
<p>Digital Input prompts for Software Options</p>		<p>SOFTWARE OPTIONS DIGITAL INPUTS—The following Digital Input selections appear only when the Healthwatch Software Option is installed.</p>

Function Prompt Lower Display	Selections or Range of Setting Upper Display	Parameter Definition															
Digital Input Prompts for Healthwatch	RESETT1 RESETT2 RESETT3 R ALL T RESETC1 RESETC2 RESETC3 R ALL C RALLTC	<p>TIMER 1 will be reset when contact closes. TIMER 2 will be reset when contact closes. TIMER 3 will be reset when contact closes. ALL TIMERS will be reset when contact closes. COUNTER 1 will be reset when contact closes. COUNTER 2 will be reset when contact closes. COUNTER 3 will be reset when contact closes. ALL COUNTERS will be reset when contact closes. ALL TIMERS AND COUNTERS will be reset when contact closes.</p>															
Digital Input Prompts for multiple Set Point Programs		<p>SETPOINT PROGRAM SELECTION—This feature can be used to remotely select which Setpoint Program is active when multiple Setpoint Programs are enabled. Requires two Digital Inputs – one configured as PROG HI and one configured as PROG LO – in order to select all four programs.</p> <p>ATTENTION These Digital Inputs force the SP Program selection and override the keyboard.</p>															
	PROG LO PROG HI	<table border="1"> <thead> <tr> <th>PROG HI</th> <th>PROG LO</th> <th>Selected SP Program</th> </tr> </thead> <tbody> <tr> <td>OFF</td> <td>OFF</td> <td>SP Program #1</td> </tr> <tr> <td>OFF</td> <td>ON</td> <td>SP Program #2</td> </tr> <tr> <td>ON</td> <td>OFF</td> <td>SP Program #3</td> </tr> <tr> <td>ON</td> <td>ON</td> <td>SP Program #4</td> </tr> </tbody> </table> <p>ATTENTION If only PROG LO is enabled, then PROG HI is assumed to be “OFF”. This is useful when only SP Programs 1 and 2 are used as it allows the user to select between these two SP Programs with a single Digital Input.</p>	PROG HI	PROG LO	Selected SP Program	OFF	OFF	SP Program #1	OFF	ON	SP Program #2	ON	OFF	SP Program #3	ON	ON	SP Program #4
PROG HI	PROG LO	Selected SP Program															
OFF	OFF	SP Program #1															
OFF	ON	SP Program #2															
ON	OFF	SP Program #3															
ON	ON	SP Program #4															
DIG1COMB	DISABLE +PID2 +TO DIR +TO SP2 +DIS AT	<p>DIGITAL INPUT 1 COMBINATION SELECTIONS—This selection allows the specified function to occur in addition to the one chosen for DIG IN 1.</p> <p>DISABLE—Disables combination function.</p> <p>PLUS PID2—Contact closure selects PID Set 2.</p> <p>PLUS DIRECT ACTION—Contact closure selects direct controller action.</p> <p>PLUS SETPOINT 2—Contact closure puts the controller to Local Setpoint 2.</p> <p>PLUS DISABLE ADAPTIVE TUNE—Contact closure disables Accutune process.</p>															

Function Prompt Lower Display	Selections or Range of Setting Upper Display	Parameter Definition
	+TO SP1 +RUN +To SP3	<p>PLUS SETPOINT 1—Contact closure puts the controller to Local Setpoint 1.</p> <p>PLUS RUN SETPOINT PROGRAM/RAMP—Contact closure starts SP Program/Ramp if enabled.</p> <p>PLUS SETPOINT 3 —Contact closure puts the controller to local setpoint 3.</p>
DIG INP2	Same selections as for Digital Input 1	DIGITAL INPUT 2 SELECTIONS
DIG2COMB	Same selections as Digital Input 1 Combinations	DIGITAL INPUT 2 COMBINATIONS
DIG INP3	Same selections as for Digital Input 1	DIGITAL INPUT 3 SELECTIONS
DIG INP4	Same selections as for Digital Input 1	DIGITAL INPUT 4 SELECTIONS
Dion LP2	NONE DI 2 DI 2, 3 DI2, 3, 4	<p>DIGITAL INPUTS ON LOOP 2—Used when Two Loops or Internal Cascade are configured. Digital Inputs are assigned to Loop 2 per this configuration. All other Digital Inputs are assigned to Loop 1</p> <p>NONE—No Digital Inputs on Loop 2, all on Loop 1</p> <p>DI 2—Assign Digital Input 2 to Loop 2</p> <p>DI 2,3—Assign Digital Inputs 2 and 3 to Loop 2</p> <p>DI 2,3,4—Assign Digital Inputs 2, 3 and 4 to Loop 2</p> <p>ATTENTION When Setpoint Program is configured to operate on both control loops, then any digital input configured for TO RUN, TO HOLD, RERUN, or To BEGIN will control the setpoint program regardless of the loop to which the Digital Input is assigned.</p>

3.23 Communications Set Up Group

Introduction

The Communications group lets you configure the controller to be connected to a host computer via Modbus[®] or Ethernet TCP/IP protocol.

Introduction

A controller with a communications option looks for messages from the host computer. If these messages are not received within the configured shed time, the controller will SHED from the communications link and return to stand-alone operation. You can also set the SHED output mode and setpoint recall, and communication units.

Up to 99 addresses can be configured over this link. The number of units that can be configured depends on the link length, with 31 being the maximum for short link lengths and 15 drops being the maximum at the maximum link length.

Function Prompts

Table 3-23 Communications Group Function Prompts

Function Prompt Lower Display	Selections or Range of Setting Upper Display	Parameter Definition
Com ADDR	1 to 99	COMMUNICATIONS STATION ADDRESS —This is a number that is assigned to a controller that is to be used with the communications option. This number will be its address. This value is also used for IR transactions.
ComSTATE	DISABLE MODBUS ETHERNE	COMMUNICATIONS SELECTION —enables the RS-485 or Ethernet communications port. DISABLE —Disables communications option. MODBUS —Enables RS-485 Modbus RTU communication port. Appears only when a communications board is installed. ETHERNET —Enables Ethernet communications port. Appears only when a communication board is installed.
IR ENABLE	DISABLE ENABLE	IR ENABLE —Disable/Enables IR communications port. ATTENTION If there are no IR communications transactions for four minutes, then the IR port automatically shuts down. It can be re-enabled at any time by pressing any key on the front panel.

Function Prompt Lower Display	Selections or Range of Setting Upper Display	Parameter Definition																								
BAUD	4800 9600 19200 38400	<p>BAUD RATE—Communications transmission speed in bits per second. This value is used for both RS-485 and IR Communications, but for IR Communications, values below 19200 baud are interpreted as being 19200 baud.</p> <p>4800 BAUD 9600 BAUD 19200 BAUD 38400 BAUD</p>																								
TX DELAY	1 to 500 milliseconds	<p>TX DELAY—Configurable response-delay timer allows you to force the instrument to delay its response for a time period of from 1 to 500 milliseconds compatible with the host system hardware/software.</p>																								
WS FLOAT	FP_B FP_BB FP_L FP_LB	<p>Defines word/byte order of floating point data for communications. Byte values:</p> <table border="0" style="margin-left: 40px;"> <tr> <td style="padding-right: 20px;">0</td> <td style="padding-right: 20px;">1</td> <td style="padding-right: 20px;">2</td> <td>3</td> </tr> <tr> <td>seeeeeee</td> <td>emmmmmmm</td> <td>mmmmmmmm</td> <td>mmmmmmmm</td> </tr> </table> <p>Where: s = sign, e = exponent, m = mantissa bit</p> <table border="0" style="margin-left: 40px;"> <tr> <td style="padding-right: 20px;">0</td> <td style="padding-right: 20px;">1</td> <td style="padding-right: 20px;">2</td> <td>3</td> </tr> <tr> <td>1</td> <td>0</td> <td>3</td> <td>2</td> </tr> <tr> <td>3</td> <td>2</td> <td>1</td> <td>0</td> </tr> <tr> <td>2</td> <td>3</td> <td>0</td> <td>1</td> </tr> </table>	0	1	2	3	seeeeeee	emmmmmmm	mmmmmmmm	mmmmmmmm	0	1	2	3	1	0	3	2	3	2	1	0	2	3	0	1
0	1	2	3																							
seeeeeee	emmmmmmm	mmmmmmmm	mmmmmmmm																							
0	1	2	3																							
1	0	3	2																							
3	2	1	0																							
2	3	0	1																							
SHED ENAB	DISABLE ENABLE	<p>SHED ENABLE—Disables/enables shed functionality.</p>																								
SHEDTIME	0 to 255	<p>SHED TIME—The number that represents how many sample periods there will be before the controller sheds from communications. A setting of 0 means No Shed (Unit remains in Slave Mode), 1 means 1/3 seconds delay before shed and each increment adds an additional 1/3 seconds.</p> <p>ATTENTION If ComSTATE is set to MODBUS and if SHEDENAB is set to DISABLE, then Shed Time will not be configurable.</p>																								
SHEDMODE	LAST	<p>SHED CONTROLLER MODE AND OUTPUT LEVEL—Determines the mode of local control you want when the controller is shed from the communications link.</p> <p>LAST—SAME MODE The controller will return to the same mode (manual or automatic) that it had before shed.</p>																								

Function Prompt Lower Display	Selections or Range of Setting Upper Display	Parameter Definition
	<p>TO MAN</p> <p>FSAFE</p> <p>TO AUTO</p>	<p>TO MAN—MANUAL MODE, SAME OUTPUT The controller will return to manual mode at the same output level that it had before shed.</p> <p>FSAFE—MANUAL MODE, FAILSAFE OUTPUT The controller will return to manual mode at the output value selected at Control prompt FAILSAFE.</p> <p>TO AUTO—AUTOMATIC MODE, LAST SP The controller will return to the automatic mode and the last setpoint used before shed.</p>
SHED SP	<p>TO LSP</p> <p>TO CSP</p>	<p>SHED SETPOINT RECALL—The instrument will control to the selected Setpoint following a Shed. (controller switches from using CSP to LSP)</p> <p>ATTENTION If SHEDENAB is configured for DISABLE, then this prompt will not be configurable. NOTE: if a RSP is the current setpoint, a CSP override will not be used. CSP overrides local setpoint only.</p> <p>TO LSP—When a Shed occurs, the controller switches from slave to monitor mode and uses the last local setpoint prior to the slave mode. The CSP value is disregarded on Shed.</p> <p>TO CSP—When a SHED timeout occurs, the controller switches from slave to monitor mode and uses the local setpoint that is set equal to the CSP value.</p>
UNITS	<p>ENG</p> <p>PERCENT</p>	<p>COMPUTER SETPOINT UNITS</p> <p>ENG—Engineering units</p> <p>PERCENT—Percent of PV range</p>
CSP RATO	<p>–20.0 to 20.0</p>	<p>COMPUTER SETPOINT RATIO—Computer setpoint ratio for Loop 1.</p>
CSP BIAS	<p>–999. to 9999. (engineering units)</p>	<p>COMPUTER SETPOINT BIAS—Computer setpoint bias in Engineering Units for Loop 1.</p>
CSP2RATO	<p>–20.0 to 20.0</p>	<p>LOOP 2 COMPUTER SETPOINT RATIO— Computer setpoint ratio for Loop 2.</p>
CSP2BIAS	<p>–999. to 9999. (engineering units)</p>	<p>LOOP 2 COMPUTER SETPOINT BIAS—Computer setpoint bias in Engineering Units for Loop 2.</p>

Function Prompt Lower Display	Selections or Range of Setting Upper Display	Parameter Definition
<p>LOOPBACK</p>	<p>DISABLE ENABLE</p>	<p>LOCAL LOOPBACK—Tests the RS-485 communications port. This feature is not used for any other communications port.</p> <p>DISABLE—Disables the Loopback test.</p> <p>ENABLE—Allows RS-485 Loopback test. The instrument goes into Loopback mode in which it sends and receives its own message. The instrument displays PASS or FAIL status in the upper display and LOOPBACK in the lower display while the test is running. The instrument will go into manual mode when LOOPBACK is enabled with the output at the Failsafe value. The test will run until the operator disables it here or until power to the instrument is turned off and on.</p> <p>ATTENTION The instrument does not have to be connected to the external RS-485 communications link in order to perform this test. If it is connected, then only one instrument should run the Loopback test at a time, as the instrument running the Loopback test transmits on the RS-485 bus. The host computer should not be transmitting on the link while the Loopback test is active.</p>

3.24 Alarms Set Up Group

Introduction

The UDC3500 has four alarms and eight alarm setpoints. Each alarm has its own hysteresis configuration.

An alarm is an indication that an event that you have configured (for example—Process Variable) has exceeded one or more alarm limits. There are up to four alarms available. Each alarm has two setpoints. You can configure each of these two setpoints to alarm on various controller parameters.

There are two alarm output selections for each alarm setpoint, High and Low. These allow you to choose whether the alarm activates when the measured value is above (High) or below (Low) the alarm setpoint. You can also configure the two setpoints to alarm on the same event and to alarm for both high and low conditions.

An adjustable Hysteresis of 0 % to 100 % is provided for each alarm.

Alarms may be conveniently broken up into four types:

1. Analog – These are alarms, which monitor selections that use analog values, such as Process Variable, Set Points or analog inputs. These alarms require a hysteresis value.
2. Digital – These are alarms which monitor status that are either ON or OFF, such as Mode (e.g., Manual), Digital Input status. These alarms do not use a hysteresis value.
3. Events – The alarms are only used with Set Point Programming and may be configured to operate at the beginning or end of a particular segment.
4. Loop Break – Loop Break is a special kind of alarm, which monitors the control loop. Although this is a digital alarm (i.e., the alarm is either broken or it is not), it requires that an analog value to be configured in order to operate properly.

See Table 2-3 in the *Installation* section for Alarm relay contact information.

ATTENTION

If the controller is configured to use the same relay for more than one function, then the following priority is used to determine how the relay functions: Control Outputs take precedence over Alarms, which in turn take precedence over Time/Events, which in turn take precedence over Logic Gate Outputs. For example, if you select the Loop 2 Output Algorithm as Time Simplex (which uses Relay 3), enable Alarm 3 (which also uses Relay 3) and configure a Logic Gate to use Relay 3, then the instrument will use Relay #3 to perform the Time Simplex output and ignore the Alarm and Logic Gate functions.

The prompts for the Alarm Outputs appear whether or not the alarm relays are physically present or used for some other function. This allows the Alarm status to be shown on the display and/or sent via communications to a host computer.

Function Prompts

Table 3-24 ALARMS Group Function Prompts

Function Prompt Lower Display	Selections or Range of Setting Upper Display	Parameter Definition
A1S1TYPE	NONE INPUT 1 INPUT 2 INPUT 3 INPUT 4 INPUT 5 PV DEV OUTPUT SHED EV ON EV OFF MANUAL REM SP F SAFE PV RATE DIG INP 1 DIG INP 2 DIG INP 3 DIG INP 4 TCWARN TCFAIL PVHOLD BREAK TOTAL	<p>ALARM 1 SETPOINT 1 TYPE—Select what you want Setpoint 1 of Alarm 1 to represent. It can represent the Process Variable, Deviation, Input 1, Input 2, Output, and if you have a model with communications, you can configure the controller to alarm on SHED. If you have setpoint programming, you can alarm when a segment goes ON or OFF.</p> <p>NO ALARM INPUT 1 INPUT 2 INPUT 3 INPUT 4 INPUT 5 PROCESS VARIABLE DEVIATION (NOTE 3) OUTPUT (NOTE 1) SHED FROM COMMUNICATIONS EVENT ON (SP PROGRAMMING) EVENT OFF (SP PROGRAMMING) ALARM ON MANUAL MODE (NOTE 2) REMOTE SETPOINT ALARM ON FAILSAFE PV RATE OF CHANGE (NOTE 11) DIGITAL INPUT 1 ACTUATED DIGITAL INPUT 2 ACTUATED DIGITAL INPUT 3 ACTUATED DIGITAL INPUT 4 ACTUATED THERMOCOUPLE WARNING (NOTE 5) THERMOCOUPLE FAIL (NOTE 6) PV HOLD (NOTE 8) LOOP BREAK (NOTE 4) TOTALIZER (NOTE 7)</p>
Alarms for Software Options		<p>ALARMS FOR SOFTWARE OPTIONS—The following Alarm Type selections appear only when one of the Software Options is installed.</p>
Alarm prompts for Two Loops/Cascade Option	PV 2 DEV 2 OUT 2 MAN 2 RSP 2 FSAFE 2 PVRATE2 BREAK 2 PV2HOLD	<p>PROCESS VARIABLE—LOOP 2 DEVIATION – LOOP 2 OUTPUT – LOOP 2 ALARM ON MANUAL MODE – LOOP 2 REMOTE SETPOINT – LOOP 2 ALARM ON FAILSAFE – LOOP 2 PV RATE OF CHANGE – LOOP 2 LOOP BREAK – LOOP 2 (NOTE 4) PV HOLD – LOOP 2</p>

Function Prompt Lower Display	Selections or Range of Setting Upper Display	Parameter Definition
Alarm prompts for Healthwatch Option	TIMER1 TIMER2 TIMER3 COUNT1 COUNT2 COUNT3	TIMER 1 —Healthwatch Maintenance Timer 1 TIMER 2 —Healthwatch Maintenance Timer 2 TIMER 3 —Healthwatch Maintenance Timer 3 COUNT 1 —Healthwatch Maintenance Counter 1 COUNT 2 —Healthwatch Maintenance Counter 2 COUNT 3 —Healthwatch Maintenance Counter 3 ATTENTION See NOTE 9 and NOTE 10.

ATTENTION

NOTE 1: When the controller is configured for Three Position Step Control, alarms set for Output will not function.

NOTE 2: Alarm 1 is not available if the Timer is enabled because Alarm 1 is dedicated to Timer output.

NOTE 3: This Deviation Alarm is based upon deviation from whichever Local or Remote SP is active.

NOTE 4: Loop Break alarms monitor the selected control loop to determine if it is working. When enabled, the control output is checked against the minimum and maximum output limit settings. When the output reaches one of these limits, a timer begins. If the timer expires and the output has not caused the PV to move by a pre-determined amount, then the alarm activates, thus signaling that the loop is broken. The loop break timer value must be configured by the operator as the AxSx VAL entry. This value is in seconds with a range of 0 to 3600 seconds. A setting of 0 is equivalent to an instantaneous loop break when the output reaches one of its limit values.

The amount of PV Movement required is determined by the “UNIT” setting in the Display Setup Group. For the Degrees F configuration, the PV must move by 3° in the time allowed. For the Degrees C configuration, the PV must move by 2° in the time allowed. For the “NONE” selection, the PV must move 1% of the PV range in the time allowed.

Loop Break alarms do not have a HIGH/LOW State configuration, they are always assumed to be a HIGH state alarm.

Only one alarm setpoint should be configured for Loop Break. If more than one is assigned, only one will function as intended and the others will not operate.

NOTE 5: Thermocouple Warning means that the instrument has detected that a Thermocouple input is starting to fail. This alarm also triggers if the Thermocouple further degrades to the Thermocouple Fail stage or if the input fails. Not valid for input types other than Thermocouple types.

NOTE 6: Thermocouple Failing means that the instrument has detected that a Thermocouple input is in imminent danger of failing. This alarm also triggers if the input fails. Not valid for input types other than Thermocouple types.

NOTE 7: For Totalizer Alarms, the Alarm Setpoint value is based upon the configured Totalizer Scale Factor (See Section 3.12).

For example:

- Totalizer Scale Factor: *E4 = $1 \times 10^4 = 10,000$
- Alarm Type: Totalizer
- Alarm SP: 400
- Alarm High / Low: HIGH

Alarm will activate when the Totalizer Value exceeds $400 \times 10^4 = 4,000,000$.

Function Prompt Lower Display	Selections or Range of Setting Upper Display	Parameter Definition
<p>NOTE 8: The PV HOLD alarm will turn on whenever the instrument is put into the PV HOLD mode. The Alarm Setpoint Value for this alarm is the number of seconds before the alarm turns on after the PV HOLD mode starts.</p> <p>NOTE 9: The setpoint values for Healthwatch Timer Alarms are in Hours and fractions of an hour. For example, a setpoint value of 20.10 would be for twenty hours and six minutes.</p> <p>NOTE 10: When both alarm setpoints for a particular alarm are configured for the same Healthwatch timer or counter, then the Setpoint 1 value turns on the alarm while the Setpoint 2 value turns off the alarm and resets the timer or counter. For example:</p> <p> If:</p> <p> Alarm 1 Setpoint 1 (AL1 SP1) is configured for TIMER 2 Alarm 1 Setpoint 2 (AL1 SP2) is configured for TIMER 2 Alarm 1 Setpoint 1 Value (A1S1 VAL) is configured for 10.00 (ten hours) Alarm 1 Setpoint 2 Value (A1S2 VAL) is configured for 11.00 (eleven hours)</p> <p> Then:</p> <p> When Timer 2 reaches 10.00 hours, Alarm 1 will turn on When Timer 2 reaches 11.00 hours, Alarm 1 will turn off and Timer 2 will be reset to 0.00</p> <p>NOTE 11: The setpoint value for PV Rate alarms is in Engineering Units (EU) per minute.</p>		
A1S1 VAL	Value in Engineering Units	ALARM 1 SETPOINT 1 VALUE —This is the value at which you want the alarm type chosen in prompt A1S1TYPE to actuate. The value depends upon what the setpoint has been configured to represent. No value is required for alarms configured for Controller Mode, Communications Shed, Failsafe, Thermocouple Warning, Thermocouple Fail or Digital Inputs. For SP Programming events, the value is the segment number for which the event applies.
A1S1 H L A1S1 EV	HIGH LOW	<p>If Setpoint Programming is disabled or if the Alarm Type is not configured for Event On/Off:</p> <p>ALARM 1 SETPOINT 1 STATE—Select whether you want the alarm type chosen in prompt A1S1TYPE to alarm High or Low. No value is required for alarms configured for Healthwatch items.</p> <p>HIGH ALARM LOW ALARM</p> <p>If Setpoint Programming is enabled and if the Alarm Type is configured for Event On/Off:</p> <p>ALARM 1 SEGMENT EVENT 1—Select whether you want the alarm type chosen in prompt A1S1TYPE to alarm the beginning or end of a segment in setpoint Ramp/Soak programming.</p>

Function Prompt Lower Display	Selections or Range of Setting Upper Display	Parameter Definition
	BEGIN END	BEGINNING OF SEGMENT END OF SEGMENT ATTENTION Alarms configured for events will not operate on Setpoint Program segments of zero length.
A1S2TYPE	Same as A1S1 TYPE	ALARM 1 SETPOINT 2 TYPE —Select what you want Setpoint 2 of Alarm 1 to represent. The selections are the same as A1S1TYPE. In addition, Alarms configured in the Time Event Group may also use this setpoint (OR condition). See Section 3.29.
A1S2 VAL	Same as A1S1 VAL	ALARM 1 SETPOINT 2 VALUE —Same as A1S1 VAL.
A1S2 H L A1S2 EV	HIGH LOW BEGIN END	ALARM 1 SETPOINT 2 STATE —Same as A1S1 H L. ALARM 1 SEGMENT EVENT 2 —Same as A1S1 EV.
ALHYST1	0.0 to 100.0 % of span or full output as appropriate	ALARM HYSTERESIS FOR ALARM 1 —An adjustable hysteresis is provided such that when Alarm 1 is OFF it activates at exactly the alarm setpoint; when Alarm 1 is ON, it will not deactivate until the variable is 0.0 % to 100 % away from the alarm setpoint. Configure the hysteresis of the alarms based on INPUT signals as a % of input range span. Configure the hysteresis of the alarm based on OUTPUT signals as a % of the full scale output range.
A2S1TYPE	Same as A1S1 TYPE	ALARM 2 SETPOINT 1 TYPE —Select what you want Setpoint 1 of Alarm 2 to represent. The selections are the same as A1S1TYPE. ATTENTION Not available with Relay Duplex or Position Proportional output types unless using Dual Relay PWA.
A2S1 VAL	Same as A1S1 VAL	ALARM 2 SETPOINT 1 VALUE —Same as A1S1 VAL.
A2S1 H L A2S1 EV	HIGH LOW BEGIN END	ALARM 2 SETPOINT 1 STATE —Same as A1S1 H L. ALARM 2 SEGMENT EVENT 1 —Same as A1S1 EV.

Function Prompt Lower Display	Selections or Range of Setting Upper Display	Parameter Definition
A2S2TYPE	Same as A1S1 TYPE	<p>ALARM 2 SETPOINT 2 TYPE—Select what you want Setpoint 2 of Alarm 2 to represent.</p> <p>The selections are the same as A1S1TYPE. In addition, Alarms configured in the Time Event Group may also use this setpoint (OR condition). See Section 3.29.</p> <p>ATTENTION Not applicable with Relay Duplex or Position Proportional output types unless using Dual Relay PWA.</p>
A2S2 VAL	Same as A1S1 VAL	ALARM 2 SETPOINT 2 VALUE —Same as A1S1 VAL.
A2S2 H L A2S2 EV	HIGH LOW BEGIN END	<p>ALARM 2 SETPOINT 2 STATE—Same as A1S1 H L.</p> <p>ALARM 2 SEGMENT EVENT 2—Same as A1S1 EV.</p>
ALHYST2	0.0 to 100.0 % of span or full output as appropriate	ALARM HYSTERESIS FOR ALARM 2 —Same as ALHYST1.
A3S1TYPE	Same as A1S1 TYPE	<p>ALARM 3 SETPOINT 1 TYPE—Select what you want Setpoint 1 of Alarm 3 to represent.</p> <p>The selections are the same as A1S1TYPE.</p> <p>ATTENTION Not applicable with Relay Duplex or Position Proportional output types unless using Dual Relay PWA.</p>
A3S1 VAL	Same as A1S1 VAL	ALARM 3 SETPOINT 1 VALUE —Same as A1S1 VAL.
A3S1 H L A3S1 EV	HIGH LOW BEGIN END	<p>ALARM 3 SETPOINT 1 STATE—Same as A1S1 H L.</p> <p>ALARM 3 SEGMENT EVENT 1—Same as A1S1 EV.</p>
A3S2TYPE	Same as A1S1 TYPE	<p>ALARM 3 SETPOINT 2 TYPE—Select what you want Setpoint 2 of Alarm 3 to represent.</p> <p>The selections are the same as A1S1TYPE. In addition, Alarms configured in the Time Event Group may also use this setpoint (OR condition). See Section 3.29.</p> <p>ATTENTION Not applicable with Relay Duplex or Position Proportional output types unless using Dual Relay PWA.</p>
A3S2 VAL	Same as A1S1 VAL	ALARM 3 SETPOINT 2 VALUE —Same as A1S1 VAL.

Function Prompt Lower Display	Selections or Range of Setting Upper Display	Parameter Definition
A3S2 H L	HIGH LOW	ALARM 3 SETPOINT 2 STATE —Same as A1S1 H L.
A3S2 EV	BEGIN END	ALARM 3 SEGMENT EVENT 2 —Same as A1S1 EV.
ALHYST3	0.0 to 100.0 % of span or full output as appropriate	ALARM HYSTERESIS FOR ALARM 3 —Same as ALHYST1.
A4S1TYPE	Same as A1S1 TYPE	ALARM 4 SETPOINT 1 TYPE —Select what you want Setpoint 1 of Alarm 4 to represent. The selections are the same as A1S1TYPE. ATTENTION Not applicable with Relay Duplex or Position Proportional output types unless using Dual Relay PWA.
A4S1 VAL	Same as A1S1 VAL	ALARM 4 SETPOINT 1 VALUE —Same as A1S1 VAL.
A4S1 H L	HIGH LOW	ALARM 4 SETPOINT 1 STATE —Same as A1S1 H L.
A4S1 EV	BEGIN END	ALARM 4 SEGMENT EVENT 1 —Same as A1S1 EV.
A4S2TYPE	Same as A1S1 TYPE	ALARM 4 SETPOINT 2 TYPE —Select what you want Setpoint 2 of Alarm 4 to represent. The selections are the same as A1S1TYPE. In addition, Alarms configured in the Time Event Group may also use this setpoint (OR condition). See Section 3.29. ATTENTION Not applicable with Relay Duplex or Position Proportional output types unless using Dual Relay PWA.
A4S2 VAL	Same as A1S1 VAL	ALARM 4 SETPOINT 2 VALUE —Same as A1S1 VAL.
A4S2 H L	HIGH LOW	ALARM 4 SETPOINT 2 STATE —Same as A1S1 H L.
A4S2 EV	BEGIN END	ALARM 4 SEGMENT EVENT 2 —Same as A1S1 EV.
ALHYST4	0.0 to 100.0 % of span or full output as appropriate	ALARM HYSTERESIS FOR ALARM 4 —Same as ALHYST1.
ALM OUT1		LATCHING ALARM OUTPUT 1 —Alarm output 1 can be configured to be Latching or Non-latching.

Function Prompt Lower Display	Selections or Range of Setting Upper Display	Parameter Definition
	NoLATCH LATCH	<p>NoLATCH —Non-latching LATCH—Latching</p> <p>ATTENTION When configured for latching, the alarm will stay active after the alarm condition ends until the Run/Hold key is pressed.</p>
BLOCK	DISABLE ALARM 1 ALARM 2 ALARM 3 ALARM 4 ALARM12 ALARM123 ALRM1234	<p>ALARM BLOCKING—Prevents nuisance alarms when the controller is first powered up. The alarm is suppressed until the parameter gets to the non-alarm limit or band. Alarm blocking affects both alarm setpoints.</p> <p>DISABLE—Disables blocking ALARM 1—Blocks alarm 1 only ALARM 2—Blocks alarm 2 only ALARM 3—Blocks alarm 3 only ALARM 4—Blocks alarm 4 only ALARM 1 & 2—Blocks alarm 1 and 2 only ALARM 1, 2 & 3—Blocks alarm 1, 2 and 3 only ALARM 1, 2, 3 & 4—Blocks all alarms</p> <p>ATTENTION When enabled on power up or initial enabling via configuration, the alarm will not activate unless the parameter being monitored has not been in an alarm condition for a minimum of one control cycle (167 ms).</p>
DIAGNOST	DISABLE ALARM 1 ALARM 2 ALARM 3 ALARM 4 DISWARN	<p>DIAGNOSTIC ALARM—Monitors all Current Outputs configured for 4-20mA operation for an open circuit condition. If any of these outputs falls below about 3.5 mA, then an Alarm is activated. This configuration is in addition to whatever was selected for AxSxTYPE.</p> <p>DISABLE—Disables Diagnostic Alarm ALARM 1—Alarm 1 is diagnostic alarm ALARM 2—Alarm 2 is diagnostic alarm ALARM 3—Alarm 3 is diagnostic alarm ALARM 4—Alarm 4 is diagnostic alarm DISABLE WARNING—Disables Output Fail messages on lower display</p>
ALRM MSG	DISABLE ENABLE	<p>ALARM MESSAGE—When enabled, a diagnostic message will appear on the lower display whenever an alarm is active. This message can be disabled by pressing the RUN/HOLD key, similar to other diagnostic messages. See Section 7.5 for messages.</p>

3.25 Real Time Clock Set Up Group

Introduction

This group configures the Real Time Clock option.

ATTENTION

The Real Time Clock will not automatically adjust for Daylight Savings Time; it must be done manually.

The Real Time Clock will automatically adjust for Leap Years to make February 29 days long.

Function Prompts

Table 3-25 CLOCK Group Function Prompts

Function Prompt Lower Display	Selections or Range of Setting Upper Display	Parameter Definition
HOURS	0 to 23	HOURS
MINUTES	0 to 59	MINUTES
SECONDS	0 to 59	SECONDS
YEAR	2005 to 2099	YEAR
MONTH	JANUARY to DECEMBR	MONTH
DAY	1 to 31	DAY
SET CLK?	NO YES	CHANGE CLOCK SETTING? —Change the clock setting? NO —Leave the clock values as they are. YES —Change the values. Pressing the Func key sets the clock. Pressing any other key will not set the clock. “YES” will also clear a CLOCKERR diagnostic message.
ADJUST	-31 to +31	ADJUST —The clock speed can be adjusted via this parameter. A setting of zero represents no adjustment. Each positive increment represents a clock change of +10.7 seconds per month. Each negative increment represents a clock change of -5.35 seconds per month. These values correspond to a total adjustment range of between +5.5 and -2.75 minutes per month.

3.26 Maintenance Set Up Group

Introduction

The Maintenance group prompts are part of the Healthwatch feature. These prompts let you count and time the activity of discrete events such as relays, alarms, control modes and others, to keep track of maintenance needs.

Function Prompts

Table 3-26 MAINTENANCE Group Function Prompts

Function Prompt Lower Display	Selections or Range of Setting Upper Display	Parameter Definition
TIME1	DISABLE LASTRES AL1 SP1	TIMER 1 —The timer tracks the elapsed time of the selected event. DISABLE —Disables the timer. LAST RESET —Time elapsed since the last reset. ALARM 1 SETPOINT 1 —Cumulative time Alarm 1 Setpoint 1 was activated.
	AL1 SP2	ALARM 1 SETPOINT 2 —Cumulative time Alarm 1 Setpoint 2 was activated.
	AL2 SP1	ALARM 2 SETPOINT 1 —Cumulative time Alarm 2 Setpoint 1 was activated.
	AL2 SP2	ALARM 2 SETPOINT 2 —Cumulative time Alarm 2 Setpoint 2 was activated.
	AL3 SP1	ALARM 3 SETPOINT 1 —Cumulative time Alarm 3 Setpoint 1 was activated.
	AL3 SP2	ALARM 3 SETPOINT 2 —Cumulative time Alarm 3 Setpoint 2 was activated.
	AL4 SP1	ALARM 4 SETPOINT 1 —Cumulative time Alarm 4 Setpoint 1 was activated.
	AL4 SP2	ALARM 4 SETPOINT 2 —Cumulative time Alarm 4 Setpoint 2 was activated.
	MANUAL	LOOP 1 MANUAL —Cumulative time Loop 1 was in Manual.
	GUAR SK	GUARANTEED SOAK —Cumulative time the process was outside the guaranteed soak band.
	SOOTNG	SOOTING —Cumulative time process was in sooting state
	DIGIN1	DIGITAL INPUT1 —Cumulative time Digital Input 1 was closed
	DIGIN2	DIGITAL INPUT 2 —Cumulative time Digital Input 2 was closed
	DIGIN3	DIGITAL INPUT3 —Cumulative time Digital Input 3 was closed
	DIGIN4	DIGITAL INPUT 4 —Cumulative time Digital Input 4 was closed
	MANUAL2	LOOP 2 MANUAL —Cumulative time Loop 2 was in Manual.

Function Prompt Lower Display	Selections or Range of Setting Upper Display	Parameter Definition
TIME 2	Same as TIME 1	TIMER 2 —The timer tracks the elapsed time of the selected event.
TIME 3	Same as TIME 1	TIMER 3 —The timer tracks the elapsed time of the selected event.
COUNT 1	DISABLE MANUAL AL1SP1 AL1SP2 AL2SP1 AL2SP2 AL3SP1 AL3SP2 AL4SP1 AL4SP2 DIGIN1 DIGIN2 DIGIN3 DIGIN4 OUT1*1K OUT2*1K OUT3*1K OUT4*1K OUT5*1K GUAR SK PWRCYC PVRANGE	COUNTER 1 —The counter counts the number of times the selected event has occurred. DISABLE —Counter is not in use. LOOP 1 MANUAL —Number of times Loop 1 has been in Manual mode. ALARM 1 SETPOINT 1 —Number of times Alarm 1 Setpoint 1 has been activated. ALARM 1 SETPOINT 2 —Number of times Alarm 1 Setpoint 2 has been activated. ALARM 2 SETPOINT 1 —Number of times Alarm 2 Setpoint 1 has been activated. ALARM 2 SETPOINT 2 —Number of times Alarm 2 Setpoint 2 has been activated. ALARM 3 SETPOINT 1 —Number of times Alarm 3 Setpoint 1 has been activated. ALARM 3 SETPOINT 2 —Number of times Alarm 3 Setpoint 2 has been activated. ALARM 4 SETPOINT 1 —Number of times Alarm 4 Setpoint 1 has been activated. ALARM 4 SETPOINT 2 —Number of times Alarm 4 Setpoint 2 has been activated. DIGITAL INPUT 1 —Number of times Digital Input 1 has closed. DIGITAL INPUT 2 —Number of times Digital Input 2 has closed. DIGITAL INPUT 3 —Number of times Digital Input 3 has closed. DIGITAL INPUT 4 —Number of times Digital Input 4 has closed. OUTPUT 1 RELAY x 1000 —Thousands of times Output 1 relay has been activated. OUTPUT 2 RELAY x 1000 —Thousands of times Output 2 relay has been activated. OUTPUT 3 RELAY x 1000 —Thousands of times Output 3 relay has been activated. OUTPUT 4 RELAY x 1000 —Thousands of times Output 4 relay has been activated. OUTPUT 5 RELAY x 1000 —Thousands of times Output 5 relay has been activated. GUARANTEED SOAK —Number of times unit has been in guaranteed soak. POWER CYCLE —Number of times unit’s power has cycled off and on. LOOP 1 PV RANGE —Number of times Loop 1’s PV

Function Prompt Lower Display	Selections or Range of Setting Upper Display	Parameter Definition
	FAILSAFE TUNE MANUAL2 PVRANG2 FAILSF2 TUNE2	has been out of range. LOOP 1 FAILSAFE —Number of times Loop 1 has been in Failsafe mode. LOOP 1 TUNE —Number of times Loop 1 has been tuned (manually and automatically) LOOP 2 MANUAL —Number of times Loop 2 has been in Manual mode. LOOP 2 PV RANGE —Number of times Loop 2's PV has been out of range. LOOP 2 FAILSAFE —Number of times Loop 2 has been in Failsafe mode. LOOP 2 TUNE —Number of times Loop 2 has been tuned (manually and automatically).
COUNT 2	Same as COUNTER1	COUNTER 2 —The counter counts the number of times the selected event has occurred.
COUNT 3	Same as COUNTER1	COUNTER 3 —The counter counts the number of times the selected event has occurred.
PASSWORD	0-9999	PASSWORD —Entering the designated number resets to zero the timer or counter specified by Reset Type. To designate a number as the password: 1. Set all timers and counters to DISABLE. 2. Enter the desired PASSWORD (0-9999). 3. Select a Reset Type (next prompt). The PASSWORD goes into effect when you press the Func key, that is, you can then use it to reset the counters and timers.
RES TYPE	NONE TIMER1 TIMER2 TIMER3 ALL TMR COUNT 1 COUNT 2 COUNT 3 ALL CNT ALL T+C	RESET TYPE —Select which timers and/or counters will be reset to zero when the PASSWORD is entered. NONE —No values will be reset TIMER 1 will be reset TIMER 2 will be reset TIMER 3 will be reset ALL TIMERS will be reset COUNTER 1 will be reset COUNTER 2 will be reset COUNTER 3 will be reset ALL COUNTERS will be reset ALL TIMERS AND COUNTERS will be reset

3.27 Display Set Up Group

Introduction

This group includes selections for Decimal place, Units of temperature, Language and Power frequency.

Function Prompts

Table 3-27 DISPLAY Group Function Prompts

Function Prompt Lower Display	Selections or Range of Setting Upper Display	Parameter Definition
DECIMAL	NONE ONE TWO THREE	<p>DECIMAL POINT LOCATION—This selection determines where the decimal point appears in the display.</p> <p>NONE—No Decimal Place—fixed, no auto-ranging ONE—One Place TWO—Two Places THREE—Three Places</p> <p>ATTENTION Auto-ranging will occur for selections of one, two or three decimal places. For example, should the instrument be configured for two decimal places and the PV exceeds 99.99, then the display will change to a single decimal place so that values of 100.0 and above can be shown.</p>
DECIMAL2	NONE ONE TWO THREE	<p>DECIMAL POINT LOCATION FOR LOOP 2—This selection determines where the decimal point appears in the display for Loop 2.</p> <p>NONE—No Decimal Place—fixed, no auto-ranging ONE—One Place TWO—Two Places THREE—Three Places</p> <p>ATTENTION Auto-ranging will occur for selections of one, two, or three places.</p>
TEMP UNIT	DEG F DEG C NONE	<p>TEMPERATURE UNITS FOR BOTH LOOPS—This selection will affect the indication and operation.</p> <p>DEG F—Degrees Fahrenheit – Degrees F Annunciator lighted</p> <p>DEG C—Degrees Centigrade – Degrees C Annunciator lighted</p> <p>NONE—No temperature annunciators lighted. Upper and Lower Displays will show temperature in Degrees Fahrenheit when inputs are configured for Thermocouple or RTD types.</p>

Function Prompt Lower Display	Selections or Range of Setting Upper Display	Parameter Definition
PWR FREQ	60 HZ 50 HZ	<p>POWER LINE FREQUENCY—Select whether your controller is operating at 50 or 60 Hertz. Incorrect setting of this parameter may cause normal mode noise problems in the input readings.</p> <p>ATTENTION For controllers powered by +24 Vdc, this configuration should be set to the AC line frequency used to produce the +24 Vdc supply.</p>
RATIO 2	DISABLE ENABLE	<p>INPUT 2 RATIO—This enables the Ratio for Input 2 to be set from the front panel. Input 2 must be installed and enabled for this configuration to operate.</p> <p>DISABLE—Disables setting Ratio 2 from front panel.</p> <p>ENABLE—Allows the Ratio for Input 2 to be set through the keyboard.</p>
LANGUAGE	ENGLISH FRENCH GERMAN SPANISH ITALIAN	<p>LANGUAGE—This selection designates the prompt language.</p> <p>ENGLISH FRENCH GERMAN SPANISH ITALIAN</p>
TC DIAGN	ENABLE DISABLE	<p>THERMOCOUPLE DIAGNOSTICS—Enable or disable Thermocouple diagnostic messages on the Lower Display.</p> <p>ENABLE—Enable Diagnostic Messages</p> <p>DISABLE—Disable Diagnostic Messages</p>
IDNUMBER	0 to 255	<p>IDENTIFICATION NUMBER—This configuration is used only for uniquely identifying a particular controller over a communications network. The value selected has no effect on how the controller operates.</p>

3.28 Read Maintenance Set Up Group

Introduction

The Read Maintenance group prompts are part of the Healthwatch feature. These prompts let you view the values of the Healthwatch Timers and Counters. All of the values in this Set Up Group are “Read Only” and cannot be changed.

Function Prompts

Table 3-28 READ MAINTENANCE Group Function Prompts

Function Prompt Lower Display	Selections or Range of Setting Upper Display	Parameter Definition
DAYS 1	0 to 9999	Shows elapsed time of Timer 1 in Days.
HRS.MIN1	00.00 to 23.59	Shows elapsed time of Timer 1 in Hours and Minutes.
DAYS 2	0 to 9999	Shows elapsed time of Timer 2 in Days.
HRS.MIN2	00.00 to 23.59	Shows elapsed time of Timer 2 in Hours and Minutes.
DAYS 3	0 to 9999	Shows elapsed time of Timer 3 in Days.
HRS.MIN3	00.00 to 23.59	Shows elapsed time of Timer 3 in Hours and Minutes.
COUNTS 1	0-9999 (1 = 1000 counts for output relays 1 to 5)	Shows the value of Counter 1.
COUNTS 2	Same as COUNTS 1	Shows the value of Counter 2.
COUNTS 3	Same as COUNTS 1	Shows the value of Counter 3.

3.29 Time Events Set Up Group

Introduction

This group appears only when the Real Time Clock option is installed. These selections allow the user to program the instrument to perform specific functions at the same time of day five or seven days a week or on one specific date and time. Up to two independent functions can be configured.

Function Prompts

Table 3-29 TIME EVT Group Function Prompts

Function Prompt Lower Display	Selections or Range of Setting Upper Display	Parameter Definition
EVENT 1	NONE ALM1SP2 ALM2SP2 ALM3SP2 ALM4SP2 STrSP/R TIMER AUTO MAN FS USE SP1 USE SP2	EVENT 1 —The function performed by this event. NONE ALARM 1 SETPOINT 2 (NOTE 1) ALARM 2 SETPOINT 2 (NOTE 1) ALARM 3 SETPOINT 2 (NOTE 1) ALARM 4 SETPOINT 2 (NOTE 1) START SETPOINT PROGRAM OR RAMP TIMER (NOTE 6) AUTOMATIC MODE (NOTE 2) MANUAL MODE AT FAILSAFE OUTPUT (NOTE 2) CONTROL TO LOCAL SETPOINT 1 (NOTE 2) CONTROL TO LOCAL SETPOINT 2 (NOTE 2)
TIME 1	5DAY WK 7DAY WK DAYofWK CALENDR	TIME 1 —Time of first event. FIVE-DAY WEEK —The configured event will occur at the same time Monday through Friday. SEVEN-DAY WEEK —The configured event will occur at the same time Sunday through Saturday. SAME DAY EVERY WEEK —The configured event will occur once a week at the configured time. CALENDAR —The configured event will occur once at a specific date and time.
HOUR 1	0 to 23	HOUR —24 Hour setting
MINUTE1	0 to 59	MINUTE —60 Minute setting
MONTH 1	JANUARY – DECEMBR	MONTH —Month of the Year (NOTE 3)
DAY 1	1 to 31 1 to 7	DAY —Day of Month or Week When “CALENDR” is configured: Day of the month (NOTE 5) When “DAYofWK” is configured: Day of the week (Sunday = 1, Saturday = 7) (NOTE 4)

Function Prompt Lower Display	Selections or Range of Setting Upper Display	Parameter Definition
EVENT 2	Same as Event 1	EVENT 2
TIME 2	Same as Time 1	TIME 2
HOURL 2	Same as Hour 1	HOURL 2
MINUTE2	Same as Minute1	MINUTE 2
MONTH 2	Same as Month 1	MONTH 2 (NOTE 3)
DAY 2	Same as Day 1	DAY 2 (NOTE 4)

NOTE 1: When triggered, the configured alarm becomes active for 1 minute and then turns off. The Time Event setting is in addition to whatever the Alarm X Setpoint 2 Type (where X = 1, 2, 3 or 4) is configured for and effectively acts as an OR condition. See Section 3.24.

NOTE 2: These prompts are loop dependent. When only one loop is configured, then both EVENT 1 and EVENT 2 operate on Loop 1. When Two Loops or Cascade are configured, then these prompts for EVENT 1 operate only on Loop 1, while these prompts for EVENT 2 operate only on Loop 2.

NOTE 3: These prompts appear only when the TIME 1 or TIME 2 configuration is "CALENDR".

NOTE 4: These prompts appear only when the TIME 1 or TIME 2 configuration is "CALENDR" or "DAYofWK".

NOTE 5: The range of DAY 1 or DAY 2 is restricted based upon the MONTH 1 or MONTH 2 selection. For example, a selection of APRIL for the MONTH 1 configuration will restrict the DAY 1 configuration to a range of 1 to 30.

NOTE 6: Only operates on SP Program #1.

3.30 P.I.E. Tool Ethernet and Email Configuration Screens

Introduction

These screens only appear in instruments that have Ethernet Communications. Ethernet and Email parameters can only be configured via the Process Instrument Explorer (P.I.E. Tool®). The figures in this section show screen-shots of the Configuration Screens from the PC version of the P.I.E. Tool®. Pocket PC Configuration Screens are generally similar in format but smaller.

Ethernet Configuration Screen

This controller is shipped from the factory with the IP Address set to 10.0.0.2, the Subnet Mask set to 255.255.255.0 and the Default Gateway set to 0.0.0.0. Consult your Information Technologies (IT) representative as to how these should be configured for your installation. The MAC address is printed on the product label located on the instrument's case.

These settings can be changed via the Ethernet Configuration Screen as shown in Figure 3-3.

See Section 4.32 – *Configuring your Ethernet Connection* for more information.

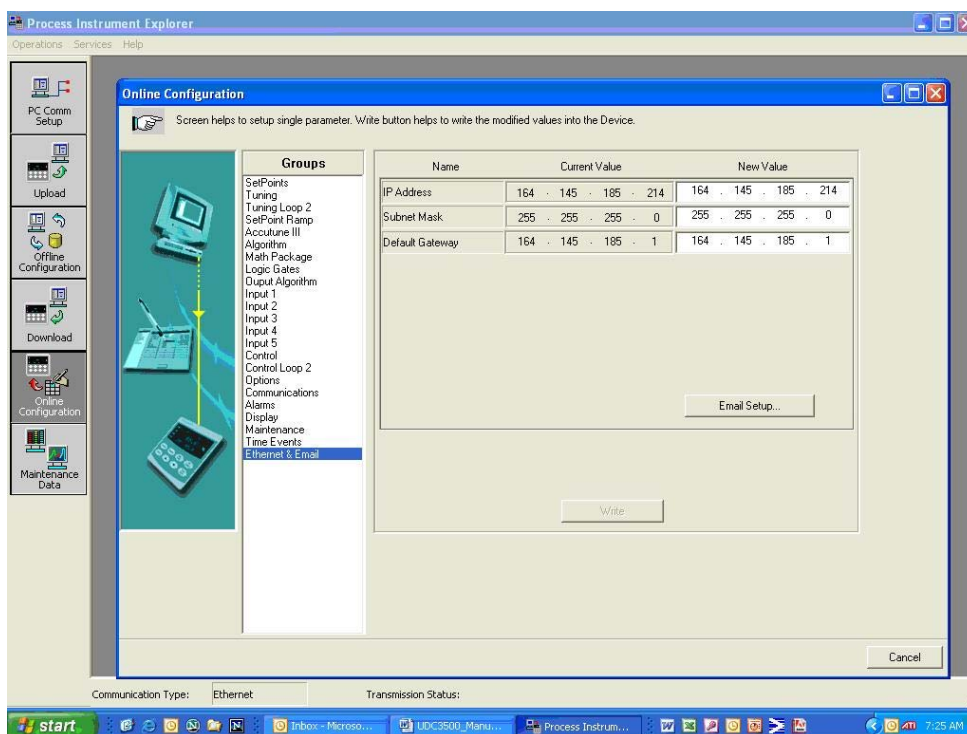

Figure 3-3 Ethernet Configuration Screen

WARNING

After you change the IP Address, you will no longer be able to communicate with the instrument via Ethernet until you change the P.I.E. Tool's IP Address setting in the "PC COMM SETUP" to match the setting that is now in your controller.

Email Configuration Screen

This controller may be configured to support up to two Emails. Each Email can be sent to a different address. Emails are sent only when the selected alarm transitions from the OFF to the ON state.

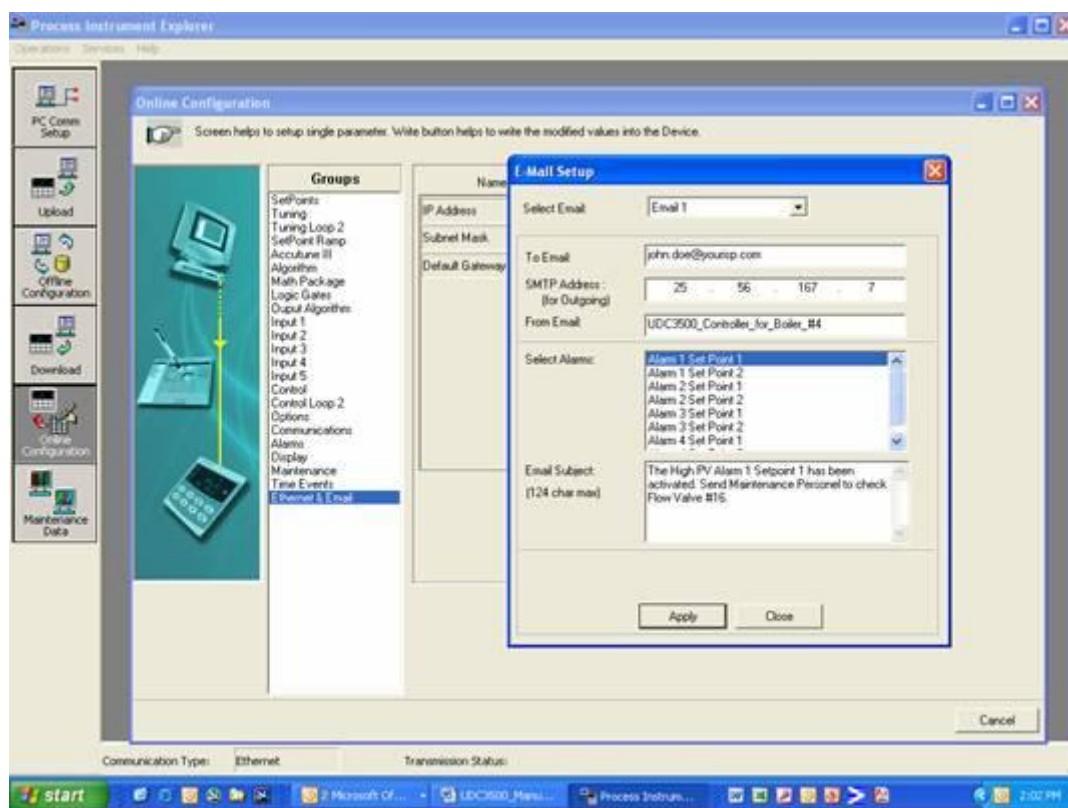

Figure 3-4 Email Configuration Screen

This controller cannot receive Emails, so it is suggested that you configure the "From Email:" window with a non-Email style address that will make it easy for you to determine which controller sent the Email. For Email technical reasons, the entry in the "From Email:" window cannot have spaces. See Figure 3-4.

If you do not know your SMTP IP Address for outgoing Email, then contact your Information Technologies (IT) representative. If your PC is on the same LAN that will be used by the controller and which also connects to the Email server, then the SMTP IP Address may generally be found by opening a DOS shell and typing:

ping smtp.[your domain name and extension, i.e., "yourisp.com"]

The content of the Emails sent by this controller contains the Alarm that triggered the Email, its settings and the current value (if applicable) of the monitored variable. For example, the content of an Email triggered by Alarm 1 Setpoint 1 that is configured to monitor Input 1 would look something like this:

Name: Alarm 1 SP1, Type: INPUT1, Event: HIGH/END, Value = 500.00,
Actual = 712.69

The content of an Email triggered by Alarm 2 Setpoint 1 that is configured to monitor Digital Input 1 would look something like this:

Name: Alarm 2 SP1, Type: DIG IN1, Event: HIGH/END, Value = 0.00,
Actual = 0.00

ATTENTION

Instruments that do not have the Real Time Clock option will always send Email time-stamped with the date that the Ethernet Software in the instrument was last modified. Instruments with the Real Time Clock option will send Email time-stamped with the current time in the controller.

If the SMTP address on your network is changed, such as can happen when a server is replaced, then you must reconfigure the Email SMTP IP address in this instrument to match.

3.31 Configuration Record Sheet

Enter the value or selection for each prompt on this sheet so you will have a record of how your controller was configured. See Section 4.30 for the SetPoint Programming configuration record sheet.

Table 3-30 Configuration Record Sheet

Group Prompt	Function Prompt	Value or Selection	Factory Setting
LOOP 1 TUNING	PROP BD or GAIN		1.000
	RATE MIN		0.00
	RSET MIN or RSET RPM		1.00
	MAN RSET		0
	PROP BD2 or GAIN2		1.00
	RATE 2 MIN		0.00
	RSET2MIN or RSET2RPM		1.00
	PROP BD3or GAIN3		1.00
	RATE 3 MIN		0.00
	RSET3MIN or RSET3RPM		1.00
	PROP BD4or GAIN4		1.00
	RATE 4MIN		0.00
	RSET4MIN or RSET4RPM		1.00
	CYC SEC or CYC SX3		20
	CYC2SEC or CYC2SX3		20
	SECURITY		0
LOCKOUT		CALIB	
AUTO MAN		ENABLE	
RUN HOLD		ENABLE	
SP SEL		ENABLE	
LOOP 2 TUNING	PROP BD or GAIN		1.000
	RATE MIN		0.00
	RSET MIN or RSET RPM		1.00
	MAN RSET		0
	PROP BD2 or GAIN2		1.00
	RATE 2 MIN		0.00
	RSET2MIN or RSET2RPM		1.00
	PROP BD3or GAIN3		1.00
	RATE 3 MIN		0.00
	RSET3MIN or RSET3RPM		1.00
	PROP BD4or GAIN4		1.00
	RATE 4MIN		0.00
	RSET4MIN or RSET4RPM		1.00
CYC SEC or CYC SX3		20	
SP RAMP	SP RAMP		DISABLE
	TIME MIN		3
	FINAL SP		1000
	HOT START		DISABLE
	SP RATE		DISABLE
	EU/HR UP		0
	EU/HR DN		0
	SP PROG		DISABLE
			For SP Program #1 record sheet – see Figure 4-8
PROGRAM2	PROGRAM2		DISABLE
PROGRAM3	PROGRAM3		DISABLE

Group Prompt	Function Prompt	Value or Selection	Factory Setting
PROGRAM4	PROGRAM4		DISABLE
	For SP Program #4 record sheet – see Figure 4-11		
ACCUTUNE	FUZZY		DISABLE
	ACCUTUNE		DISABLE
	DUPLEX		MANUAL
	SP CHANGE		10
	KPG		1.00
	CRITERIA		FAST
	ACCUTUN2		DISABLE
	DUPLEX		MANUAL
	SP CHANG2		10
	KPG2		1.00
	CRITERIA2		FAST
	AT ERROR		READ ONLY
AT ERR 2		READ ONLY	
ALGORITHM	CONT ALG		PID A
	PIDLOOPS		1 or 2
	CONT2ALG		PID A
	OUT OVRD		DISABLE
	TIMER		DISABLE
	PERIOD		0.01
	START		KEY
	LWR DISP		TI REM
	RESET		KEY
	INCREMENT		MINUTE
	INALG1		NONE
	MATH K		--
	CALC HI		--
	CALC LO		--
	ALG1 INA		--
	ALG 1 INB		--
	ALG1 INC		--
	PCO SEL		DISABLE
	PCT CO		0.200
	PCT H2		--
	ATM PRESS		780.0
	ALG1 BIAS		--
	INALG2		NONE
	MATH K2		--
	CALC HI		--
	CALC LOW		--
	ALG2 INA		--
	ALG2 INB		--
	ALG2 INC		--
	ALG2 BIAS		--

Group Prompt	Function Prompt	Value or Selection	Factory Setting
MATH	8SEG CH1		DISABLE
	X1 VALUE		0
	X2 VALUE		0
	X3 VALUE		0
	X4 VALUE		0
	X5 VALUE		0
	X6 VALUE		0
	X7 VALUE		0
	X8 VALUE		0
	Y1 VALUE		0
	Y2 VALUE		0
	Y3 VALUE		0
	Y4 VALUE		0
	Y5 VALUE		0
	Y6 VALUE		0
	Y7 VALUE		0
	Y8 VALUE		0
	8 SEG CH2		DISABLE
	X9 VALUE		0
	X10 VALUE		0
	X11 VALUE		0
	X12 VALUE		0
	X13 VALUE		0
	X14 VALUE		0
	X15 VALUE		0
	X16 VALUE		0
	X17 VALUE		0
	Y9 VALUE		0
	Y10 VALUE		0
	Y11 VALUE		0
	Y12 VALUE		0
	Y13 VALUE		0
	Y14 VALUE		0
	Y15 VALUE		0
	Y16 VALUE		0
	Y17 VALUE		0
	TOTALIZE		DISABLE
	ΣXXXXXXX		--
	TOT SCALE		E0
	TOT SCR		UNLOCK
	Σ RESET?		NO
	TOT RATE		SECOND
	POLYNOM		DISABLE
	C0 VALUE		0
C1 VALUE		0	
C2 X 10 ⁻¹		0	
C2 X 10 ⁻³		0	
C2 X 10 ⁻⁵		0	
C2 X 10 ⁻⁷		0	

Group Prompt	Function Prompt	Value or Selection	Factory Setting
LOGIC	LOG GATE		DISABLE
	GATE1TYP		NOT USED
	GATE1INA		CONST K
	GATE1 K		0
	GATE1INB		FIXED OFF
	GATE1OUT		ANY GATE
	GATE2TYP		NOT USED
	GATE2INA		CONST K
	GATE2 K		0
	GATE2INB		FIXED OFF
	GATE2OUT		ANY GATE
	GATE3TYP		NOT USED
	GATE3INA		CONST K
	GATE3 K		0
	GATE3INB		FIXED OFF
	GATE3OUT		ANY GATE
	GATE4TYP		NOT USED
	GATE4INA		CONST K
	GATE4 K		0
	GATE4INB		FIXED OFF
	GATE4OUT		ANY GATE
GATE5TYP		NOT USED	
GATE5INA		CONST K	
GATE5 K		0	
GATE5INB		FIXED OFF	
GATE5OUT		ANY GATE	
OUTPUT	OUT ALG		CURRENT
	OUT RNG		100PCT
	C1 RANGE		4-20mA
	RLYSTATE		1OF2ON
	RLY TYPE		MECHAN
	MOTOR TI		5
	OUT2 ALG		CURRENT
	OUT2 RNG		100PCT
	C3 RANGE		4-20mA
	RLYSTAT2		1OF2ON
	CUR OUT1		DISABLE
	LOW VAL		0.0
	HIGH VAL		100.0
INPUT 1	IN1 TYPE		0-10mV
	XMITTER1		LINEAR
	IN1 HIGH		1000
	IN1 LOW		0
	RATIO 1		1.00
	BIAS IN1		0
	FILTER 1		0
	BURNOUT1		NONE
EMISSIV1		0.00	
INPUT 2	IN2 TYPE		0-10mV
	XMITTER2		LINEAR
	IN2 HIGH		1000
	IN2 LOW		0
	RATIO 2		1.00
	BIAS IN2		0
	FILTER 2		0
	BURNOUT2		NONE
EMISSIV2		0.00	

Group Prompt	Function Prompt	Value or Selection	Factory Setting
INPUT 3	IN3 TYPE		0-10mV
	XMITTER3		LINEAR
	IN3 HIGH		1000
	IN3 LOW		0
	RATIO 3		1.00
	BIAS IN3		0
	FILTER 3		0
	BURNOUT3		NONE
INPUT 4	EMISSIV3		0.00
	IN4 TYPE		0-10mV
	XMITTER4		LINEAR
	IN4 HIGH		1000
	IN4 LOW		0
	RATIO 4		1.00
	BIAS IN4		0
	FILTER 4		0
INPUT 5	BURNOUT4		NONE
	IN5 TYPE		0-10mV
	XMITTER5		LINEAR
	IN5 HIGH		1000
	IN5 LOW		0
	RATIO 5		1.00
	BIAS IN5		0
	FILTER 5		0
CONTROL	BURNOUT5		NONE
	PV SOURC		INPUT 1
	PID SETS		1 ONLY
	SW VAL12		0
	SW VAL23		0
	SW VAL34		0
	LSP'S		1 ONLY
	RSP SRC		NONE
	AUTOBIAS		DISABLE
	SP TRACK		NONE
	PWR MODE		MANUAL
	PWR OUT		LAST
	SP HiLIM		1000
	SP LoLIM		0
	ACTION		REVERSE
	OUT RATE		DISABLE
	PCT/M UP		0
	PCT/M DN		0
	OUTHILIM		100
	OUTLoLIM		0.0
	I Hi LIM		100
	I Lo LIM		0
	DROPOFF		0
	DEADBAND		1.0
	OUT HYST		0.5
	FAILMODE		NO LATCH
	FAILSAFE		0.0
	SW FAIL		0
	MAN OUT		0
	AUTO OUT		0
PBorGAIN		GAIN	
MINorRPM		MIN	

Group Prompt	Function Prompt	Value or Selection	Factory Setting
CONTROL2	PV 2SRC		INPUT 2
	LINK LPS		DISABLE
	PID SETS		1 ONLY
	SW VAL 12		0
	SW VAL23		0
	SW VAL34		0
	LSP'S		1 ONLY
	RSP SRC		NONE
	AUTOBIAS		DISABLE
	SP TRACK		NONE
	PWRMODE		MANUAL
	SP HiLIM		1000
	SP LoLIM		0
	ACTION		REVERSE
	OUT RATE		DISABLE
	PCT/M UP		0
	PCT/M DN		0
	OUTHILIM		100
	OUTLoLIM		0
	I Hi LIM		100.0
	I Lo LIM		0.0
	DROPOFF		0
	DEADBAND		1.0
FAILMODE		NO LATCH	
FAILSAFE		0	
OPTIONS	CUR OUT2		DISABLE
	C2RANGE		4-20mA
	LOW VAL		0
	HIGH VAL		100
	CUR OUT3		DISABLE
	C3RANGE		4-20Ma
	LOW VAL		0
	HIGH VAL		100
	DIG1 INP		NONE
	DIG1 COMB		DISABLE
	DIG INP2		NONE
	DIG2 COMB		DISABLE
	DIG INP3		NONE
	DIG INP4		NONE
	Dion LP2		NONE
COM	Com ADDR		3
	ComSTATE		DISABLE
	IR ENABLE		DISABLE
	BAUD		19200
	TX DELAY		1
	WSFLOAT		FP B
	SHEDENAB		DISABLE
	SHEDTIME		0
	SHEDMODE		LAST
	SHEDSP		TO LSP
	UNITS		PERCENT
	CSP RATO		1.0
	CSP BIAS		0
	CSP2RATO		1.0
	CSP2BIAS		0
LOOPBACK		DISABLE	

Group Prompt	Function Prompt	Value or Selection	Factory Setting
ALARMS	A1S1TYPE		NONE
	A1S1 VAL		90
	A1S1 H L		HIGH
	A1S1 EV		--
	A1S2 TYPE		NONE
	A1S2 VAL		10
	A1S2 H L		LOW
	A1S2 EV		--
	ALHYST1		0.1
	A2S1TYPE		NONE
	A2S1 VAL		95
	A2S1 H L		HIGH
	A2S1 EV		--
	A2S2TYPE		NONE
	A2S2 VAL		5
	A2S2 H L		LOW
	A2S2 EV		--
	ALHYST2		0.1
	A3S1TYPE		NONE
	A3S1 VAL		95
	A3S1 H L		HIGH
	A3S1 EV		--
	A3S2TYPE		NONE
	A3S2 VAL		5
	A3S2 H L		LOW
	A3S2 EV		--
	ALHYST3		0.1
	A4S1TYPE		NONE
	A4S1 VAL		95
	A4S1 H L		HIGH
	A4S1 EV		--
	A4S2TYPE		NONE
	A4S2 VAL		5
A4S2 H L		LOW	
A4S2 EV		--	
ALHYST4		0.1	
ALM OUT1		NO LATCH	
BLOCK		DISABLE	
DIAGNOST		DISABLE	
ALRM MSG		DISABLE	
CLOCK	HOURS		SET TO FACTORY TIME
	MINUTES		" " " "
	SECONDS		" " " "
	YEAR		" " " "
	MONTH		" " " "
	DAY		" " " "
	SET CLK?		" " " "
ADJUST		0	
MAINTNCE	TIME 1		DISABLE
	TIME 2		DISABLE
	TIME 3		DISABLE
	COUNT 1		DISABLE
	COUNT 2		DISABLE
	COUNT 3		DISABLE
	PASSWORD		0
RES TYPE		NONE	

Group Prompt	Function Prompt	Value or Selection	Factory Setting
DISPLAY	DECIMAL		NONE
	DECIMAL2		NONE
	TEMPUNIT		NONE
	PWR FREQ		60 HZ
	RATIO 2		DISABLE
	LANGUAGE		ENGLISH
	TC DIAGN		ENABLE
	IDNUMBER		0
TIME EVENTS	EVENT 1		NONE
	TIME 1		--
	HOUR 1		--
	MINUTE 1		--
	MONTH 1		--
	DAY 1		--
	EVENT 2		NONE
	TIME 2		--
	HOUR 2		--
	MINUTE2		--
	MONTH 2		--
	DAY 2		--
ETHERNET AND EMAIL (Accessible via PIE Tool)	MAC Address		(case label on instrument)
	IP Address		10.0.0.2
	Subnet Mask		255.255.255.0
	Default Gateway		0.0.0.0
	SMTP Address (for Outgoing)		0.0.0.0
	To Email 1		--
	From Email 1		--
	To Email 2		--
	From Email 2		--

4 Monitoring and Operating the Controller

4.1 Overview

Introduction

This section gives you all the information necessary to help you monitor and operate your controller including an Operator Interface overview, how to lockout changes to the controller, entering a security code, and monitoring the displays.

What's in this section?

The following topics are covered in this section.

TOPIC	See Page
4.1 Overview	193
4.2 Operator Interface	194
4.3 Entering a Security Code	194
4.4 Lockout Feature	195
4.5 Monitoring Your Controller	197
4.6 Start Up Procedure for Operation	199
4.7 Control Modes	201
4.8 Setpoints	202
4.9 Timer	203
4.10 Accutune III	205
4.11 Fuzzy Overshoot Suppression	213
4.12 Using Two Sets of Tuning Constants	214
4.17 Two Loops of Control	214
4.18 Configuring Two Loops of Control	233
4.19 Monitoring Two Loops of Control	234
4.20 Operating Two Loops of Control	235
4.21 Alarm Setpoints	236
4.22 Three Position Step Control Algorithm	238
4.23 Setting a Failsafe Output Value for Restart after a Power Loss	238
4.24 Setting Failsafe Mode	240
4.25 Carbon Potential, Oxygen and Dewpoint Algorithms	240
4.26 Healthwatch	243

4.27 Setpoint Rate/Ramp/Program Overview	243
4.28 Setpoint Rate	244
4.29 Setpoint Ramp	244
4.30 Setpoint Ramp/Soak Programming	246
4.30 Setpoint Ramp/Soak Programming	246
4.31 P.I.E. Tool Maintenance Screens	261
4.32 Configuring your Ethernet Connection	271

4.2 Operator Interface

Introduction

Figure 4-1 is a view of the Operator Interface.



Figure 4-1 Operator Interface

4.3 Entering a Security Code

Introduction



The level of keyboard lockout may be changed in the Set Up mode. However, knowledge of a security code number (0 to 9999) may be required to change from one level of lockout to another. When a controller leaves the factory, it has a security code of 0 which permits changing from one lockout level to another without entering any other code number.

Procedure

If you require the use of a security code, select a number from 0001 to 9999 and enter it when the lockout level is configured as NONE. Thereafter, that selected number must be used to change the lockout level from something other than NONE.

ATTENTION Write the number on the Configuration Record Sheet in the configuration section so you will have a permanent record.

Table 4-1 Procedure to Enter a Security Code

Step	Operation	Press	Result
1	Enter Set Up Mode	Setup	<i>Upper Display = SET UP</i> <i>Lower Display = TUNING</i>
2	Select any Set Up Group	Func	<i>Upper Display = 0</i> <i>Lower Display = SECUR</i>
3	Security Code Entry	 or 	To enter a four digit number in the upper display (0001 to 9999) This will be your security code.

4.4 Lockout Feature

Introduction

The lockout feature in this instrument is used to inhibit changes (via keyboard) of certain functions or parameters by unauthorized personnel.

Lockout levels

There are different levels of Lockout depending on the level of security required. These levels are:

- **NONE** No Lockout. All groups Read/Write.
- **CALIB** Calibration prompts are deleted from the Setup List.
- **+CONFIG** Timer, Tuning, SP Ramp, and Accutune are Read/Write. All other Setup are Read only. Calibration Group is not available.
- **+VIEW** Timer, Tuning, and SP Ramp are Read/Write. No other parameters are available.
- **ALL** Timer, Tuning, and SP Ramp are Read only. No other parameters are viewable.

See *Subsection 3.4 - Tuning Parameters Set Up Group* prompts to select one of the above.

Security Code (*see Subsection 4.3*)

Individual key lockout

There are three keys that can be disabled to prevent unauthorized changes to the parameters associated with these keys. *First set the “Lock” prompt to NONE.*

These keys are:

- Run/Hold Key** - you can disable the Run/Hold key for Set Point Programming at configuration Set Up group prompt “Tuning,” function prompt “RN HLD.”
- Man/Auto Key** - you can disable the Auto/Manual key at configuration Set Up, group prompt “Tuning”, function prompt “AUTOMA”
- SP Select Key** - you can disable the Set Point Select function key at configuration Set Up group prompt “Tuning,” function prompt “SP SEL.”

See *Subsection 3.4 - Tuning Parameters Set Up Group* prompts to enable or disable these keys.

Key error

When a key is pressed and the prompt “Key Error” appears in the lower display, it will be for one of the following reasons:

- Parameter not available or locked out
- Not in setup mode, press **SET UP** key first
- Individual key locked out.

4.5 Monitoring Your Controller

4.5.1 Annunciators

The following annunciator functions have been provided to help monitor the controller:

Table 4-2 Annunciators

Annunciator	Indication
ALM 1 2 3 4	<p><i>A visual indication of the alarms</i></p> <p>A blinking annunciator indicates an alarm-latched condition. The blinking will continue and the alarm will stay activated after the alarm condition ends until it is acknowledged by pressing the Run/Hold key.</p> <p>A Logic Gate Output configured for Relay 5 will turn on the ALM 1 indicator when active. Alarms take precedence over Logic Gates.</p>
OUT 1 2 3 4	<p><i>A visual indication of the control relays</i></p> <p>Out 1 and 2 are for Loop 1, Out 3 and 4 are for Loop 2.</p> <p>Logic Gate Outputs configured for Relays 1 through 4 will turn on the respective OUT annunciator when active. Control Outputs take precedence over Logic Gates.</p>
DI 1 2 3 4	<p><i>A visual indication of each Digital Input</i></p>
A or MAN	<p><i>A visual indication of the mode of the controller</i></p> <p>A—Automatic Mode MAN—Manual Mode</p> <p>Blinking A or MAN indicates that the mode is being forced by a Digital Input.</p>
[None], F or C	<p><i>A visual indication of the temperature units</i></p> <p>[None]—No temperature unit annunciator F—Degrees Fahrenheit C—Degrees Celsius</p>
■	<p><i>A visual Lamp to indicate when the lower display is showing the Active Setpoint (Local 1, Local 2, Local 3, Local 4, Remote Setpoint or Computer Setpoint)</i></p> <p>When this lamp is blinking it indicates that the Setpoint is being forced by a Digital Input.</p> <p><i>The upper left digits of the display are used to show other annunciator functions</i></p> <p>T—Accutuning in progress t—PV tune in progress L”—Loop 2 display I—Cascade control (when Loop 1 is displayed) C—Computer setpoint active O—Output override active H—Setpoint Ramp or Setpoint Program in HOLD mode R—Setpoint Ramp or Setpoint Program in RUN mode H and R alternating—Guaranteed Soak in operation</p>

Annunciator	Indication
	2I —PV = Input 2 via a Digital Input activation
	3I —PV = Input 3 via a Digital Input activation
	Blinking indicates that the activity is being forced by a Digital Input.

4.5.2 Viewing the operating parameters

Press the **LOWER DISPLAY** key to scroll through the operating parameters listed in Table 4-3. The lower display will show only those parameters and their values that apply to your specific model and configuration.

Table 4-3 Lower Display Key Parameter Prompts

Lower Display	Description
OUT XX.X	OUTPUT—Output value is shown in percent with one decimal point for all output types except Three Position Step Control (TPSC). For TPSC, when no slidewire is connected, this display is an estimated motor position and is shown with no decimal point. For Position Proportional Control, if the slidewire fails, then the instrument automatically switches over to TPSC and the OUT display changes with it.
SP XXXX	LOCAL SETPOINT #1—Also the current setpoint when using SP Ramp.
2SP XXXX	LOCAL SETPOINT #2
3SP XXXX	LOCAL SETPOINT #3
4SP XXXX	LOCAL SETPOINT #4
RSP XXXX	REMOTE SETPOINT
1IN XXXX	INPUT 1—Used only with combinational input algorithms.
2IN XXXX	INPUT 2
3IN XXXX	INPUT 3
4IN XXXX	INPUT 4
5IN XXXX	INPUT 5
POS XX	SLIDEWIRE POSITION—Used only with TPSC applications that use a slidewire input.
CSP XXXX	COMPUTER SETPOINT—When SP is in override.
DEV XXXX	DEVIATION—Maximum negative display is -999.9.
PIDSET X	TUNING PARAMETER —where X is 1 to 4.
ET HR.MN	ELAPSED TIME—Time that has elapsed on the Timer in Hours.Minutes.
ØTR HR.MN	TIME REMAINING—Time remaining on the Timer in Hours.Minutes. The “Ø” is a rotating clock face.
RAMPXXXM	SETPOINT RAMP TIME—Time remaining in the Setpoint Ramp in minutes.
SPn XXXX	SETPOINT NOW—Current Setpoint when SP Rate is enabled. The SP XXXX display shows the “target” or final setpoint value.
PROGRAMX	SETPOINT PROGRAM NUMBER— Set Point Programming display. X is the current program number (1 to 4). When a Setpoint Program is initiated via the RUN/HOLD key, the Setpoint Program Number can be incremented/decremented via the keyboard. Digital Input Selections “PROG LO” and “PROG HI” override the keyboard and force the Program selection per their status (open or closed). When running linked programs, the Setpoint Program Number can be incremented/decremented when in the “HOLD” mode.

Lower Display	Description
XXRAHR.MN	RAMP SEGMENT NUMBER AND TIME REMAINING—Set Point Programming display. XX is the current segment number and HR.MN is the time remaining for this segment in Hours.Minutes. When the program is in the “HOLD” mode, the Segment Number can be incremented/decremented.
XXSKHR.MN	SOAK SEGMENT NUMBER AND TIME REMAINING— Set Point Programming display. XX is the current segment number and HR.MN is the time remaining for this segment in Hours.Minutes. When the program is in the “HOLD” mode, the Segment Number can be incremented/decremented.
RECYC XX	NUMBER OF SP PROGRAM RECYCLES REMAINING
To BEGIN	RESET SP PROGRAM TO START OF FIRST SEGMENT
RERUN	RESET SP PROGRAM TO START OF CURRENT SEGMENT
1PV XXXX	PROCESS VARIABLE 1—For Cascade or 2-loop applications.
2PV XXXX	PROCESS VARIABLE 2—For cascade or 2-loop applications.
OC1 XX.X	CHARACTERIZED OUTPUT 1—Displayed if Loop 1 output is characterized.
OC2 XX.X	CHARACTERIZED OUTPUT 2—Displayed if Loop 2 output is characterized.
Σ [Sigma]XXXXXXX	CURRENT TOTALIZER VALUE—Displays the total flow volume being measured.
1CO XXXX	FIRST CURRENT OUTPUT—Displayed only when the First Current Output is enabled in an Auxiliary Output mode.
2CO XXXX	SECOND CURRENT OUTPUT—Displayed only when the Second Current Output is enabled in an Auxiliary Output mode.
3CO XXXX	THIRD CURRENT OUTPUT—Displayed only when the Third Current Output is enabled in an Auxiliary Output mode.
BIA XXXX	BIAS—Displays the manual reset value for algorithm PD+MR.
OTI XX.X	OUTPUT OVERRIDE (2 PID LOOPS ONLY)—Appears when Internal Loop 1 Output value is displayed. This represents the internal output 1 value before override.
DEW XX.X	DEWPOINT TEMPERATURE—Shown only when Dewpoint Algorithm is selected as Input Algorithm 2.
TUNE OFF	LIMIT CYCLE TUNING NOT RUNNING—Appears when Accutune is enabled but not currently operating.
TUNE RUN	LIMIT CYCLE TUNING RUNNING—Appears when Accutune operation is in progress.
DO FAST	Limit Cycle Tuning with the objective of producing quarter-damped tuning parameters. This tuning may result in PV overshoot of the SP setting.
DO SLOW	Limit Cycle Tuning with the objective of producing damped or Dahlin tuning parameters, depending upon the detected process deadtime. The tuning parameters calculated by this selection are aimed at reducing PV overshoot of the SP setting.

4.5.3 Diagnostic Messages

This instrument performs background tests to verify data and memory integrity. If there is a malfunction, a diagnostic message will be shown on the lower display alternating (blinking) with the normal display. In the case of more than one simultaneous malfunction, the diagnostic messages will be shown in sequence, with the highest priority message being shown first. See *Section 7.5 - Background Tests and Diagnostic Messages* for a list of the Diagnostic Messages and how to correct the problems that they indicate.

Diagnostic messages may be suppressed (stop the blinking) by pressing the RUN/HOLD key. The messages will still be available for viewing by pressing the LOWER DISPLAY key. If the underlying condition has not been corrected, then the next time the instrument is powered-down/power-up, the diagnostic message will return.

4.6 Start Up Procedure for Operation

Table 4-4 Procedure for Starting Up the Controller

Step	Operation	Press	Result
1	Select Manual Mode	Man/Auto	Until “ M ” indicator is ON. The controller is in manual mode.
2	Adjust the Output	▲or▼	To adjust the output value and ensure that the final control element is functioning correctly. <i>Upper Display = PV Value</i> <i>Lower Display = OUT and the output value in %</i>
3	Enter the Local Setpoint	Lower Display ▲or▼	<i>Upper Display = PV Value</i> <i>Lower Display = SP and the Local Setpoint Value</i> To adjust the local setpoint to the value at which you want the process variable maintained. The local setpoint cannot be changed if the Setpoint Ramp function is running.
4	Select Automatic Mode	Man/Auto	Until “ A ” indicator is ON. The controller is in Automatic mode. The controller will automatically adjust the output to maintain the process variable at setpoint.
5	Tune the Controller	Setup	Make sure the controller has been configured properly and all the values and selections have been recorded on the Configuration Record Sheet. Refer to Tuning Set Up group to ensure that the selections for Pb or GAIN, RATE T, and I MIN, or I RPM have been entered. Use Accutune to tune the controller; see the procedure in this section.

4.7 Control Modes

ATTENTION

After changing a Local Setpoint value, if no other key is pressed then takes a minimum of fifteen (15) seconds elapsed time before the new value is stored in non-volatile memory. If controller power is removed before this time, then the new setpoint value is lost and the previous setpoint value is used at power-up. If, after changing the LSP value, another key is pressed, then the value is stored immediately.

4.7.1 Mode Definitions

Table 4-5 Control Mode Definitions

Control Mode	Definition
AUTOMATIC with LOCAL SETPOINT	In automatic local mode, the controller operates from the local setpoints and automatically adjusts the output to maintain the PV at the desired value. In this mode you can adjust the setpoint. See <i>Subsection 4.8 – Setpoints</i> .
AUTOMATIC with REMOTE SETPOINT	In automatic remote mode, the controller operates from the setpoint measured at the remote setpoint input. Adjustments are available to ratio this input and add a constant bias before it is applied to the control equation. See <i>Subsection 3.15 Input 1 or 3.17 Input 2</i> .
MANUAL	In the manual mode, the operator directly controls the controller output level. The process variable and the percent output are displayed. The configured High and Low Output Limits are disregarded and the operator can change the output value, using the increment and decrement keys, to the limits allowed by the output type (0 % to 100 % for a time proportioning output or –5 % to 105 % for a current output).
MANUAL CASCADE	In the manual cascade mode, both control loops are in manual although there is still only one output active. This mode is used to bring both loops into a reasonable operation area, at which point the unit is placed into the automatic cascade mode. If Loop 1 is placed in Manual control mode, then Loop 2, if in auto, is then placed in a pseudo-manual mode thereby eliminating output bumps when Loop 1 is returned to Automatic control mode.
AUTOMATIC CASCADE	In Automatic cascade mode, there are two control loops, with one loop's output acting as the setpoint for the second control loop. There is only one physical output in this mode.

4.7.2 What happens when you change modes

Table 4-6 Changing Control Modes

Control Mode	Definition
Manual to Automatic Local Setpoint	<p>The Local Setpoint is usually the value previously stored as the Local Setpoint.</p> <p>PV tracking is a configurable feature that modifies this. For this configuration, when the controller is in manual mode, the local setpoint value tracks the process variable value continuously. Thus, when the instrument is switched into Automatic Mode, the local setpoint is set at the current PV value.</p>
Manual or Auto Local to Automatic Remote SP	<p>The Remote Setpoint uses the stored ratio and bias to calculate the control setpoint.</p> <p>Auto bias is a configurable feature, which modifies this. When it is selected the transfer from automatic local to automatic remote or from manual remote to automatic remote adjusts the bias based on the local setpoint such that</p> $\text{Bias} = \text{LSP} - (\text{RSP Input} \times \text{R}).$
Automatic Remote Setpoint to Manual or Auto Local Setpoint	<p>If configured for local setpoint tracking, RSP, when the controller transfers out of remote setpoint the last value of the remote setpoint is inserted into the local setpoint.</p> <p>If LSP tracking is not configured, the local setpoint will not be altered when the transfer is made.</p>

4.8 Setpoints

Introduction

You can configure the following setpoints for the UDC3500 controller.



- One to four Local Setpoints
- One to four Local Setpoints plus one Remote Setpoint

Refer to *Subsection 3.20 – Control Set Up Group* for configuration details.

Whenever the active Setpoint is shown in the Lower Display, an *n* appears to the left of the Setpoint display.

Changing the Setpoints

Table 4-7 Procedure for Changing the Local Setpoints

Step	Operation	Press	Result
1	Select the Setpoint	Lower Display	Until you see: <i>Upper Display = PV</i> <i>Lower Display = SP or 2SP or 3SP or 4SP (Value)</i>
2	Change the Value	 or 	To change the Local Setpoint to the value at which you want the process maintained. The display “blinks” if you attempt to enter setpoint values beyond the high and low limits..
3	Return to PV Display	Lower Display	To store immediately or will store after 30 seconds.

Switching between setpoints

You can switch between Local Setpoints or between Local and Remote Setpoints via the SP SELECT key.

ATTENTION The REMOTE SETPOINT value cannot be changed at the keyboard.

Table 4-8 Procedure for Switching Between Setpoints

Step	Operation	Press	Result
1	Select the Setpoint	SP Select	To switch between the four Local Setpoints and/or the Remote Setpoint. Whenever the active lo ATTENTION “KEY ERROR” will appear in the lower display, if: <ul style="list-style-type: none"> the remote setpoint or additional local setpoints are not configured as a setpoint source you attempt to change the setpoint while a setpoint ramp is enabled, or if you attempt to change the setpoint with the setpoint select function key disabled. Appears to the left of the active setpoint

4.9 Timer

Introduction

The Timer provides a configurable Time-out period of from 0 to 99 hours:59 minutes or 0 to 99 minutes:99 seconds.

Timer “Start” is selectable as either the **RUN/HOLD** key or Alarm 2.

The Timer display can be either “Time Remaining” or “Elapsed Time”.

Configuration check

Make sure:

- TIMER is enabled
- A TIMEOUT period has been selected (in hours and minutes or minutes and seconds)
- A TIMER FUNCTION START has been selected (KEY or AL2)
- A TIMER display has been selected (Time remaining or Elapsed time)
- A timer increment selected
- Timer reset selected (KEY or AL1)
KEY means that the RUN/HOLD key is used to start and/or reset the timer.
AL1 means that either Alarm 1 or the RUN/HOLD key is used to start and/or reset the timer.

Refer to *Subsection 3.11 Algorithm Set Up Group* for details.

Viewing Times

The times are viewed on the lower display as follows:

TIME REMAINING will show as a *decreasing* Hrs:Min value (HH:MM) or Min:Sec value (MM:SS) plus a *counterclockwise* rotating clock face.

ELAPSED TIME will show as an *increasing* Hrs:Min value(HH:MM) or Min:Sec value (MM:SS) plus a *clockwise* rotating clock face.

Operation



When the Timer is enabled (RUN/HOLD key or ALARM 2), it has exclusive control of Alarm 1 relay.

At “**TIME-OUT**”:

- Alarm 1 is active
- The clock character has stopped moving
- The Time display shows either 00:00 or the time-out period depending on the configuration selection

- The Timer is ready to be reset either via the RUN/HOLD key or by activating Alarm 1.

When the Timer is **“RESET”**:

- Alarm 1 relay is inactive
- The timer display shows the configured timer period
- The time-out period can be changed at this time using the  or  keys.
- The Timer is ready for the next activation.

4.10 Accutune III

Introduction

Accutune III (TUNE) may be used for self-regulating and single integrating processes. This autotuning method is initiated on-demand, typically at initial start-up.

There are no other requirements necessary, such as prior knowledge to the process dynamics or initial or post tune process line-out to setpoint or manual output.

Also, the setpoint value is not required to change in order to initiate the tuning process, but the controller must be in the Automatic mode to start tuning. The process need not be in a static (lined out) state and may be dynamic (changing with a steady output).

Configuration check

Make sure:

- TUNE has been enabled see to *Subsection 3.10 – Accutune Set Up Group* for details.

Tuning indicators

A “T” will show in the leftmost alphanumeric of the upper display until tuning is completed.

Operation

The Accutune III algorithm provides user-friendly, on-demand tuning in this controller. No knowledge of the process is required at start-up. The operator simply initiates the tuning while in the automatic mode.

Once Accutune III has been enabled in the TUNE setup group, either “SLOW” or “FAST” tuning may be used. Which one is used is selected via the lower display during normal operation.

For the SLOW selection, the controller calculates conservative tuning constants with the objective of minimizing overshoot. If the controller determines that the process has appreciable dead time, it will automatically default to use Dahlin Tuning, which produces very conservative tuning constants. The SLOW selection may be useful for TPSC and

Position Proportional applications, as it reduces “hunt” problems for the motor. This selection is also recommended for applications that have significant deadtimes.

For the FAST selection, the controller calculates aggressive tuning constants with the objective of producing quarter-damped response. Depending upon the process, this selection will usually result in some overshoot. For this reason, it may be desirable to enable the FUZZY tune selection. See Section 4.11. When Fuzzy tune is enabled, it will work to suppress or eliminate any overshoot that may occur as a result of the calculated tuning parameters as the PV approaches the setpoint. This selection is best suited for processes with a single lag or for those that do not have any appreciable deadtime. FUZZY tuning does not work well for processes that have appreciable deadtime.



The Accutune III tuning process will cycle the controller’s output two full cycles between the low and high output limits while allowing only a very small Process Variable change above and below the SP during each cycle. A “T” shows in the upper display until tuning is completed.

At the end of the tuning process, the controller immediately calculates the tuning constants and enters them into the Tuning group, and begins PID control with the correct tuning parameters. This works with any process, including integrating type processes, and allows retuning at a fixed setpoint.

4.10.1 Tune for Simplex Outputs

After “TUNE” has been enabled, you can start Accutune as shown in Table 4-9.

Table 4-9 Procedure for Starting “TUNE”

Step	Operation	Press	Result
1	Configure LSP1	Lower Display	Until SP (Local Setpoint 1) shows in the lower display.
2		 or 	Until LSP1 is to the desired value.
3	Switch to “Automatic” Mode	Man/Auto	Until the “A” indicator is lighted (on controllers with Manual option).
4	Show Tuning Prompt	Lower Display	Until “TUNE OFF” is shown on lower display.
5	Initiate Tuning		Select “DO SLOW” or “DO FAST” in lower display.
6	Tuning in operation	Lower Display	Upper display will show a “T” as long as ACCUTUNE process is operating. When process completes, tuning parameters are calculated and lower display will show “NO TUNE” prompt.

ATTENTION

The Accutune process may be aborted at any time by changing the lower display back to “NoTUNE” or by switching the controller into Manual Mode.

4.10.2 Tune for Duplex (Heat/Cool)

Accutune for applications using Duplex (Heat/Cool) control.

The controller must be configured to have two local setpoints unless Blended Tuning is desired (see below). See *Subsection 3.20- Control Set Up Group* for details on configuring two local setpoints. During tuning, the Accutune III process assumes that Local Setpoint 1 will cause a Heating demand (output above 50%), and the tuning parameters calculated for that setpoint are automatically entered as PID SET 1. Likewise, Accutune III assumes that Local Setpoint 2 will cause a Cooling demand (output less than 50%), and the tuning parameters calculated for that setpoint are automatically entered as PID SET 2.

Configuration Check for Duplex

See *Subsection 3.10 – Accutune Set Up Group* for details.





Make sure:

- TUNE has been enabled
- DUPLEX has been configured to Manual, Automatic or Disabled

4.10.3 Using AUTOMATIC TUNE at start-up for Duplex (Heat/Cool)

Used when DUPLEX has been configured for AUTOMATIC. This is the preferred selection for most Heat/Cool applications when tuning a new chamber. This selection will sequentially perform both Heat and Cool tuning without further operator intervention.

Table 4-10 Procedure for Using AUTOMATIC TUNE at Start-up for Duplex Control



Step	Operation	Press	Result
1	Configure LSP1	Lower Display	Until SP (Local Setpoint 1) shows in the lower display.
2		 or 	Until LSP1 is a value within the Heat Zone (output above 50%).
3	Configure LSP2	Lower Display	Until 2SP (Local Setpoint 2) shows in the lower display.
4		 or 	Until LSP2 is a value within the Cool Zone (output below 50%).
5	Switch to "Automatic" Mode	Man/Auto	Until the "A" indicator is lighted (on controllers with Manual option).
6	Show Tuning Prompt	Lower Display	Until "TUNE OFF" is shown on lower display.
7	Initiate Tuning		Select "DO SLOW" or "DO FAST" in lower display.
	Tuning in operation	Lower Display	Upper display will show a "T" as long as ACCUTUNE process is operating. When process completes, tuning parameters are calculated and lower display will show "NO TUNE" prompt.

4.10.4 Using BLENDED TUNE at start-up for Duplex (Heat/Cool)

When DUPLEX has been configured for DISABLE. This is the preferred selection for Heat/Cool applications, which use a highly insulated chamber (a chamber which will lose heat very slowly unless a cooling device is applied). Only one local setpoint (LSP 1) is needed for this selection.

This selection results in performance tuning over the full range utilizing both Heat and Cool outputs to acquire blended tune values that are then applied to both Heat and Cool tuning parameters. Both PID sets are set to the same values.

Table 4-11 Procedure for Using BLENDED TUNE at Start-up for Duplex Control

Step	Operation	Press	Result
1	Configure LSP1	Lower Display	Until SP (Local Setpoint 1) shows in the lower display.
2		 or 	Until the Setpoint is to the desired value.
3	Switch to "Automatic" Mode	Man/Auto	Until the "A" indicator is lighted (on controllers with Manual option).
4	Show Tuning Prompt	Lower Display	Until "TUNE OFF" is shown on lower display.
5	Initiate Tuning		Select "DO SLOW" or "DO FAST" in lower display.
6	Tuning in operation	Lower Display	Upper display will show a "T" as long as ACCUTUNE process is operating. When process completes, tuning parameters are calculated and lower display will show "NO TUNE" prompt.

4.10.5 Using MANUAL TUNE at start-up for Duplex (Heat/Cool)

When DUPLEX has been configured for MANUAL. This selection should be used when tuning is needed only for the HEAT zone or only for the COOL zone but not both. If Local Setpoint 1 is used, then the controller will perform a HEAT zone tune. If Local Setpoint 2 is used, then the controller will perform a COOL zone tune.

Table 4-12 Procedure for Using MANUAL TUNE for Heat side of Duplex Control







Step	Operation	Press	Result
1	Configure LSP1	Lower Display	Until SP (Local Setpoint 1) shows in the lower display.
2		 or 	Until LSP1 is a value within the Heat Zone (output above 50%).
3	Switch to "Automatic" Mode	Man Auto	Until the "A" indicator is lighted (on controllers with Manual option).
4	Show Tuning Prompt	Lower Display	Until "TUNE OFF" is shown on lower display.
5	Initiate Tuning		Select "DO SLOW" or "DO FAST" in lower display.
6	Tuning in operation	Lower Display	Upper display will show a "T" as long as ACCUTUNE process is operating. When process completes, tuning parameters are calculated and lower display will show "NO TUNE" prompt.

Table 4-13 Procedure for Using MANUAL TUNE for Cool side of Duplex Control

Step	Operation	Press	Result
1	Configure LSP2	Lower Display	Until 2SP (Local Setpoint 2) shows in the lower display.
2		 or 	Until LSP2 is a value within the Cool Zone (output below 50%).
3	Switch to "Automatic" Mode	Man/Auto	Until the "A" indicator is lighted (on controllers with Manual option).
4	Show Tuning Prompt	Lower Display	Until "TUNE OFF" is shown on lower display.
5	Initiate Tuning		Select "DO SLOW" or "DO FAST" in lower display.
6	Tuning in operation	Lower Display	Upper display will show a "T" as long as ACCUTUNE process is operating. When process completes, tuning parameters are calculated and lower display will show "NO TUNE" prompt.

4.10.6 ACCUTUNE Error Codes

Table 4-14 Procedure for Accessing Accutune Error Codes

Step	Operation	Press	Result
1	Select Accutune Set-up Group	Setup	Upper Display = SETUP Lower Display = ACCUTUNE
2	Go to Error Code Prompt	Func	Upper Display = (an error code) Lower Display = AT ERROR Table 4-15 lists all the error codes, definitions, and fixes.

Table 4-15 Accutune Error Codes

Error Code (Upper Display)	Definition	Fix
RUNNING	ACCUTUNE RUNNING	The Accutune process is still active (Read Only)
NONE	NO ERRORS OCCURRED DURING LAST ACCUTUNE PROCEDURE	None
ID FAIL	PROCESS IDENTIFICATION FAILURE Applies only to SP or SP+PV tuning. An illegal value for Gain, Rate or Reset was calculated.	<ul style="list-style-type: none"> Illegal Values – try Accutune again. Untunable process – contact local application engineer.
ABORT	CURRENT ACCUTUNE PROCESS ABORTED caused by the following conditions: <i>a. Operator changed to Manual mode</i> <i>b. Digital Input detected</i> <i>c. In Heat region of output and a Cool output calculated or vice versa.</i>	Try Accutune again
SP2	LSP2 not enabled or LSP1 or LSP2 not in use (only applies to Duplex Tuning)	Enable LSP2 and configure the desired LSP1 and LSP2 setpoints. See <i>Section 4.10</i> .
OUTLIM	OUTPUT LIMIT REACHED (HIGH OR LOW) Applies only to SP or SP+PV tuning. Output insufficient to get to SP value.	Check the Output Limits in the Control or Control 2 Set Up groups. See <i>Section 3.20</i> or <i>Section 3.21</i> . Verify that the correct Process Gain Value, KPG or KPG2, is entered. See <i>Section 3.10</i> . ATTENTION This error will cause the controller to switch from Automatic to Manual Mode. The output is then set to the value present at the beginning of

Error Code (Upper Display)	Definition	Fix
LOW PV	<p>LOW PV</p> <p>Applies only to SP or SP+PV tuning. PV did not change sufficiently or the PV has increased by more than 4% but Deadtime was not determined.</p>	<p>the ACCUTUNE process.</p> <p>No action necessary. After approximately five minutes, the instrument will automatically attempt another SP adaptive tuning process using a larger output step.</p>

Aborting Accutune

To abort Accutune and return to the last previous operation (SP or output level), press **MAN-AUTO** key to abort the Accutune process or increment from the “DO SLOW” or “DO FAST” prompt to the “TUNE OFF” prompt.

Completing Accutune

When Accutune is complete, the calculated tuning parameters are stored in their proper memory location and can be viewed in the TUNING Set up Group, and the controller will control at the local setpoint using these newly calculated tuning constants.

4.11 Fuzzy Overshoot Suppression

Introduction

Fuzzy Overshoot Suppression minimizes Process Variable overshoot following a setpoint change or a process disturbance. This is especially useful in processes that experience load changes or where even a small overshoot beyond the setpoint may result in damage or lost product.

How it works

The Fuzzy Logic in the controller observes the speed and direction of the PV signal as it approaches the setpoint and temporarily modifies the internal controller response action as necessary to avoid an overshoot. There is no change to the PID algorithm, and the fuzzy logic does not alter the PID tuning parameters. This feature can be independently Enabled or Disabled as required by the application to work with the Accutune algorithm. Fuzzy Tune should not be enabled for processes that have an appreciable amount of deadtime.

Configuration

To configure this item, refer to Section 3 – Configuration:

Set Up Group “**ACCUTUNE**”
 Function Prompt “**FUZZY**”
 Select “**ENABLE**” or “**DISABLE**” – Use  or .

4.12 Using Two Sets of Tuning Constants

Introduction

You can use two sets of tuning constants for single output types and choose the way they are to be switched. (this does not apply for Duplex control, which always uses two PID sets).

The sets can be:



- keyboard selected,
- automatically switched when a predetermined process variable value is reached,
- automatically switched when a predetermined setpoint value is reached.



Set up Procedure

The following procedure (Table 4-16) to:

- select two sets,
- set the switch-over value,
- set tuning constant value for each set.



Table 4-16 Set Up Procedure

Step	Operation	Press	Result
1	Select Control Set-up Group	Setup	Until you see: <i>Upper Display</i> = SET <i>Lower Display</i> = CONTROL
2	Select PID SETS	Func	Until you see: <i>Upper Display</i> = (available selections) <i>Lower Display</i> = PID SETS
3	Select PID SETS Function	 or 	To select the type of function. Available selections are: 1 ONLY —1 set of constants 2KEYBD —2 sets, keyboard selectable 2PV SW —2 sets, auto switch at PV value 2SP SW —2 sets, auto switch at SP value

- 4 Set Tuning Values for Each Set
 Refer to "TUNING" Set up group, subsection 3.4 and set the following tuning parameters:
 PB or GAIN *
 RATE MIN *
 RSET MIN or RSET RPM *
 CYC SEC or CYC SX3 *
 PB2 or GAIN2 **
 RATE2MIN **
 RSET2MIN or RSET2RPM **
 CYC2SEC or CYC2SX3 **
 *PIDSET1 will be used when PV or SP, whichever is selected, is **greater** than the switchover value.
 PIDSET2 will be used when PV or SP, whichever is selected, is **less than the switchover value.
- 5 Set Switchover Value for 2 PVSW or 2 SPSW Selection
 Func Until you see:
Upper Display = (the switchover value)
Lower Display = SW VAL
-  or  To select the switchover value in the upper display.

Switch between two sets via keyboard (without automatic switch-over)

Table 4-17 Procedure for Switching PID SETS from the Keyboard

Step	Operation	Press	Result
1	Select Control Set-up Group	Lower Display	Until you see: <i>Upper Display = (the PV value)</i> <i>Lower Display = PIDS X (X= 1 or 2)</i>
2		 or 	To change PID SET 1 to PID SET2 or Vice Versa. You can use Accutune on each set.
3		Lower Display	To accept changes.

4.13 Input Math Algorithms

Introduction

This controller has two input algorithms available, some that are standard on any instrument with two or more analog inputs and some that are available as part of the Math option. Each algorithm can be configured to provide a derived (calculated) PV or a derived Remote Setpoint. Up to three inputs may be applied to the calculation. In addition, the two algorithms may be “linked” to combine two calculations by configuring one algorithm to be an input to the other algorithm.

Standard functionality

The following algorithms are provided as standard on all instruments with two or more analog inputs: Weighted Average, Feedforward Summer, Feedforward Multiplier, or Relative Humidity.

Math Options

The Math option provides additional algorithms plus two Characterizers, Totalizer, and Polynomial functions.

Input algorithm selections

Algorithm selections are made in Section 3 – Configuration. The following function prompts can be found in the Algorithm Set Up group:

IN ALG1
IN ALG2

These selections include the following algorithms:

Weighted Average
Feedforward Summer
Relative Humidity
Summer
Hi Select
Lo Select
√ Multiply Divide
√ Multiply
Multiply Divide
Multiply
Feedforward Multiplier
Carbon Potential (several types)
Oxygen
Dewpoint

The formulas for these selections are given in Section 3.11.

8 Segment Characterizers

Characterizers are available as part of the Math Algorithm option. See Section 3.12.

8SEG CH1
 X_n VALUE
 Y_n VALUE
 8SEG CH2
 X_n VALU2
 Y_n VALU2

An 8-segment characterizer can be applied to any Analog Input, Output 1, or Output 2. When an Analog Input is used, the selected input's Ratio and Bias are applied to the X_n values. The characterizers can be linked in order to provide a single 16-segment characterizer.

When one of the loop outputs is selected, the X_n Values are the output from the control algorithm, and the Y_n Output is the final control element action.

An example of an 8-segment characterizer can be found in Figure 3-2.

Totalizer

A **Flow Totalizer** is available as part of the Math Algorithm option. See Section 3.12.. This calculates and displays the total flow volume being measured by one of the analog inputs. Alternatively, it can be applied to either Input Algorithm 1 or Input Algorithm 2 to totalize the compensated flow rate as being calculated by the selected algorithm.

The **totalizer displays** the current totalized flow value (up to seven digits maximum). **Seven scaling factors** are available (from one to one million). The desired scaling factor is applied to the calculated value to extend the maximum total flow range that can be displayed.

Five integration rates are available to match the totalizer rate to the rate of flow being measured. The rates are:

Engineering units (EU) per second
 EU per minute
 EU per hour
 EU per day
 Millions of units per day

The totalizer value is stored in nonvolatile memory once every eight hours. If **power is lost** while the totalizer is in operation, the current value of the totalizer will be lost. When **power is restored**, the totalizer will start operation for the last value stored in nonvolatile memory. The **Σ (Sigma)** display will blink to indicate this condition. Reset the totalizer.

The totalizer can be **reset** from the keyboard whenever desired. The totalizer should always be reset to initialize the counters whenever it is enabled.

Alarm on totalizer value

The alarm type configuration includes an Alarm on Totalizer value. This allows an alarm setpoint value to be used to cause an alarm when exceeded. The alarm setpoint represents

the lowest four digits of the selected Totalizer Scale Factor and has a range from 0 to 9999 x Totalizer Scale Factor.

Totalizer reset via Digital Input

Any of the Digital Inputs may be configured to reset the totalizer value.

4.14 Logic Gate Operation

Introduction

The Logic Gate function lets you configure up to five Dual-Input Logic Gates.

The following gates have two **Digital** input sources and one Digital output.

OR
NOR
AND
NAND
XOR
XNOR

The following comparator gates have two **Analog** input sources and one Digital output. These comparator gates are used with Input B having a fixed hysteresis band of 0.1% of the Input B span.

B<A
B>A

Gate configuration

Refer to Section 3.13 to make your configuration choices for the following function prompts for each gate you want to configure:

GATE TYPE
INPUT A SOURCE
INPUT B SOURCE
OUTPUT USE

Gate Operation

Section 3.13 contains information defining how the different gates operate. In Digital (Binary) Logic, there are only two states that can be present; “0” meaning OFF and “1” – meaning ON.

Section 3.13 also lists the types of gates available along with their truth tables. These tables indicate what happens to the output of each gate with regard to the state of the inputs.

The rules and regulations regarding the use of the logic gates are listed in .

Table 4-18.

Table 4-18 Logic Gates Constraints and Dynamic Operation Status

Function	Rules and Regulations
Alarms	Alarms take precedent over gate outputs. For example, no gate output will occur if the Logic Gate Output is directed to Relay 5 if the Alarm 1 is also configured.
Output Algorithms	Output algorithms that use Relay outputs take precedence over gate outputs. For example, no gate output will occur if the Logic Gate Output is directed to Relay 1 when a conflicting Loop 1 output algorithm is also configured (for example: Time Simplex, Time Duplex, etc.).
Communications	<p>Communications takes priority over gate output as follows:</p> <ul style="list-style-type: none"> • No Gate Output will occur if directed to Manual/Auto and the Host computer places the unit (loop) into Manual or Automatic mode. • No Gate Output will occur if directed to Local/Remote and the Host computer selects either Local or Remote setpoint. <p>Gate output will resume when the Host computer puts the unit (loop) into the monitor state or the unit sheds from the Host.</p>
Mode or Setpoint	<p>If a Logic Gate output is configured for Manual/Auto or Local/Remote Setpoint, then pushing the Man/Auto key or the SP Select key, respectively, will result in a key error diagnostic display.</p> <p>However, the Man/Auto key is permitted during communications when the Host computer has mode control.</p>

4.15 Digital Input Option (Remote Switching)

Introduction

The Digital Input option detects the state of external contacts. On contact closure, the controller will respond according to how each digital input is configured. If the controller is configured for either Two Loop or Cascade control, then how the switches are allocated between the two loops must be defined. See Section 3.22.

Action on closure

Table 4-19 lists the configuration prompt selections, the “Action on Closure,” and the display indication for each selection available.

Table 4-19 Digital Input Option Action on Contact Closure

Digital Input Selections	Display Indication	Action on Contact Closure Controller returns (toggles) to original state when contact reopens unless otherwise noted
None	DI 1 2 3 4 always off*	No Digital Input selection <i>* If a Digital Input is configured for some action, then its associated Annunciator will always show its status; ON for Active (switch closed) and OFF for inactive (switch open). Annunciators for Digital Inputs configured as NONE will always stay off whether the switch is closed or open.</i>
TO MAN	MAN blinks	Puts the controller into manual mode. When the contact opens, the controller returns to its former mode unless the Man/Auto key was pressed while the digital input was active, in that case the controller will stay in the manual mode when the contact opens.
TO LSP	SP annunciator blinks Lower display shows LSP 1	Puts the controller into Local Setpoint 1. When contact opens, the controller returns to former operation, local or remote setpoint.
TO 2SP	SP annunciator blinks Lower display shows LSP 2	Puts the controller into Local Setpoint 2. When contact opens, the controller returns to former operation, local or remote setpoint.
TO 3SP	SP annunciator blinks Lower display shows LSP 3	Puts the controller into Local Setpoint 3. When contact opens, the controller returns to former operation, local or remote setpoint.
TO 4SP	SP annunciator blinks Lower display shows LSP 4	Puts the controller into Local Setpoint 4. When contact opens, the controller returns to former operation, local or remote setpoint.
TO DIR		Selects direct control action.
ToHOLD	H blinks	Suspends setpoint program or setpoint ramp operation. Contact open runs the ramp/program from the Hold point unless the Ramp/Program was not previously started via the Run/Hold key. This selection applies to either loop.

Digital Input Selections	Display Indication	Action on Contact Closure Controller returns (toggles) to original state when contact reopens unless otherwise noted
ToPID2	PIDSET 2 in lower display	Selects PID set 2.
PV 2IN	2I (blinking)	Selects the PV to equal Input 2.
PV 3IN	3I (blinking)	Selects the PV to equal Input 3.
RERUN		Resets the Setpoint program back to the beginning of the first segment in the program and leaves the program in the same Run or Hold mode that it was in when the DI closed. Reopening the contact has no effect.
TO RUN	R in upper display blinks	Starts a stopped SP Program. Reopening contact puts the controller in Hold mode. This selection applies to either loop.
ToBEGIN		Resets the Setpoint Program back to the beginning of the first segment in the program and places the program into the Hold mode. Reopening the contact has no effect. This selection applies to either loop.
STOP I		Disables PID Integral (I) action.
MAN FS	MAN blinks	Unit goes to manual mode, output goes to the failsafe value. This will cause a bump in the output when switching from automatic to manual mode. The switch back from manual to automatic mode is bumpless.
ToLOCK	LOCKED on lower display when a key is pressed	Disables all keys.
ToAout		Output is forced to value set at control prompt "AUTO OUT" when controller is in automatic mode. Reopening contact returns the controller to the normal output. This selection is only available on Loop 1.
TIMER	Timer clock () and time appear in lower display.	Starts timer (momentary operation). Reopening switch has no effect.
AM STA		Causes switch to Auto Manual Station mode. Refer to <i>Figure 4-2 in Section 4.16</i> for auto manual station information. This selection is only available on Loop 1.
ToTUNE	TUNE ON in lower display	Starts the Accutune process. Opening the switch has no effect.
SPinit		Forces the SP to initialize at the current PV value.
TRACK1	O in upper display blinks	Allows Output 1 to track Input 2.
TRACK2	O in upper display blinks	Allows Output 2 to track Input 2.
ToOUT2	O in upper display blinks	Allows Output 2 to override Output 1.
TO RSP	SP annunciator blinks Lower display shows RSP	Puts the controller into Remote Setpoint. When contact opens, the controller returns to former operation, local or remote setpoint.

Digital Input Selections	Display Indication	Action on Contact Closure Controller returns (toggles) to original state when contact reopens unless otherwise noted
D L1/2		Changes the display to the loop not being displayed at time of closure.
RST FB		Allows Input 2 to override the internal reset value, providing external reset feedback.
ToPURGE	MAN blinks and output value shows in lower display	Forces loop to manual mode with the output values set to the Output High Limit configuration.
PURG AX		A Digital Input assigned to Loop 1 forces any Auxiliary Output configured for OUTPUT to go to 100% (20 mA). A Digital Input assigned to Loop 2 forces any Auxiliary Output configured for OUT 2 to go to 100% (20 mA).
LoFIRE	MAN blinks and output value shows in lower display	Forces loop to manual mode with the output set to the Output Low Limit configuration.
MAN LAT		Forces loop to manual mode. Reopening the contact has no effect. To return to automatic mode, press the Man/Auto key.
RES TOT		Resets the accumulated totalizer value to zero. Reopening the contact has no effect.
PV HOLD		Closing the switch freezes the PV at its current value. When switch opens, the PV resumes normal operation.
REST T1		Reset Healthwatch Timer 1 to zero.
REST T2		Reset Healthwatch Timer 2 to zero.
REST T3		Reset Healthwatch Timer 3 to zero.
R ALL T		Reset all Healthwatch Timers to zero.
REST C1		Reset Healthwatch Counter 1 to zero.
REST C2		Reset Healthwatch Counter 2 to zero.
REST C3		Reset Healthwatch Counter 3 to zero.
R ALL C		Reset all Healthwatch Counters to zero.
R ALLTC		Reset all Healthwatch Timers and Counters to zero.

Keyboard Operation

Front panel keys have no effect on the digital input action in the closed state.

Digital Inputs 1 and 2 combination selections

The Digital Input combination selections listed in Table 4-19 can be used in combination with the Digital Inputs 1 and 2 listed in Table 4-20.

If the controller is configured for either Two Loop or Cascade control, then how the switches are allocated between the two loops must be defined. See Section 3.22.

Table 4-20 Digital Input Combinations “DIG IN1” or “DIG IN2”

Selections used in Combination with “DIG IN1” or “DIG IN2”	Display Indication	Action on Contact Closure Controller returns (toggles) to original state when contact reopens unless otherwise noted
+PID2	PIDSET 2 in lower display	Selects PID set 2.
+ToDIR		Puts the controller into direct controller action.
+ToSP2	2SP in lower display with the active SP indicator blinking	Selects the second local setpoint.
+DISAT	T indicator is no longer lit	Disables Adaptive tune.
+ToSP1		Selects the local setpoint.
+RUN	R indicator blinks	Starts or restarts RUN of SP Ramp/Program.

Digital Inputs 1 and 2 combination operation

There are five possible situations that can occur when working with digital input combinations. Table 4-21 lists these situations and the resulting action when the switch is active. In the table:

Enabled means that the parameter is configured and the action will occur when the digital input is active.

Action Disabled means that the digital input or digital combination parameter is configured but the action cannot occur when the digital input is active because the selected parameter is disabled.

Table 4-21 Digital Inputs 1 and 2 Combination

DIG IN1 or DIG IN2	DIG 1 COMB or DIG 2 COMB	Action	Example
NONE	Any Selection	No action will occur when the digital input is active.	
ENABLED	DISABLED	The DIG IN condition will occur when the Digital Input is active.	DIG IN1 = TO MAN DIG1 COM = DISABLE Loop 1 will switch to MANUAL when digital input 1 is active.
ACTION DISABLED	ENABLED	No action will occur when the digital input is active.	DIG IN1 = ToPID2 DIG1 COM = +ToSP2 PID SETS = 1 ONLY LSP'S = TWO As PID SETS is set to 1 ONLY, the DIG IN1 configuration cannot be accomplished and is thus Action Disabled . Therefore, when digital input 1 is active, no action will occur even though DIG1 COM is enabled.
ENABLED	ACTION DISABLED	Action is indeterminate when the digital input is active because of configuration errors.	DIG IN1 = ToPID2 DIG1 COM = +ToSP2 PID SETS = 2KEYBD LSP'S =1 ONLY As there is only one LSP configured, the DIG1 COM configuration cannot be accomplished and is thus Action Disabled . Therefore, the action will be indeterminate when DIG IN1 is active.
ENABLED	ENABLED	Both DIG IN and DIG COM action will occur.	DIG IN1 = ToPID2 DIG1 COM = +ToSP2 PID SETS = 2KEYBD LSP'S =TWO Instrument is correctly configured for both actions and thus will perform as desired when DIG IN1 is active.

4.16 Auto/Manual Station

Introduction

When you select “AM STA” (auto manual station) for one of the Digital Inputs, contact closure on the selected Digital Input causes the controller to switch to Auto/Manual Station mode. See Section 3.22. You may have an Auto/Manual station on either loop or on both loops.

Function

As shown in Figure 4-2, State 2 is the “A/M Station mode” where the programmable logic controller (PLC) output is sent through the Auto/Manual Station. You can switch to manual and change the output at the controller. (It uses PID set 2.)

State 1 is the “Backup PID mode” which is triggered by opening the digital input. (It uses PID set 1.)

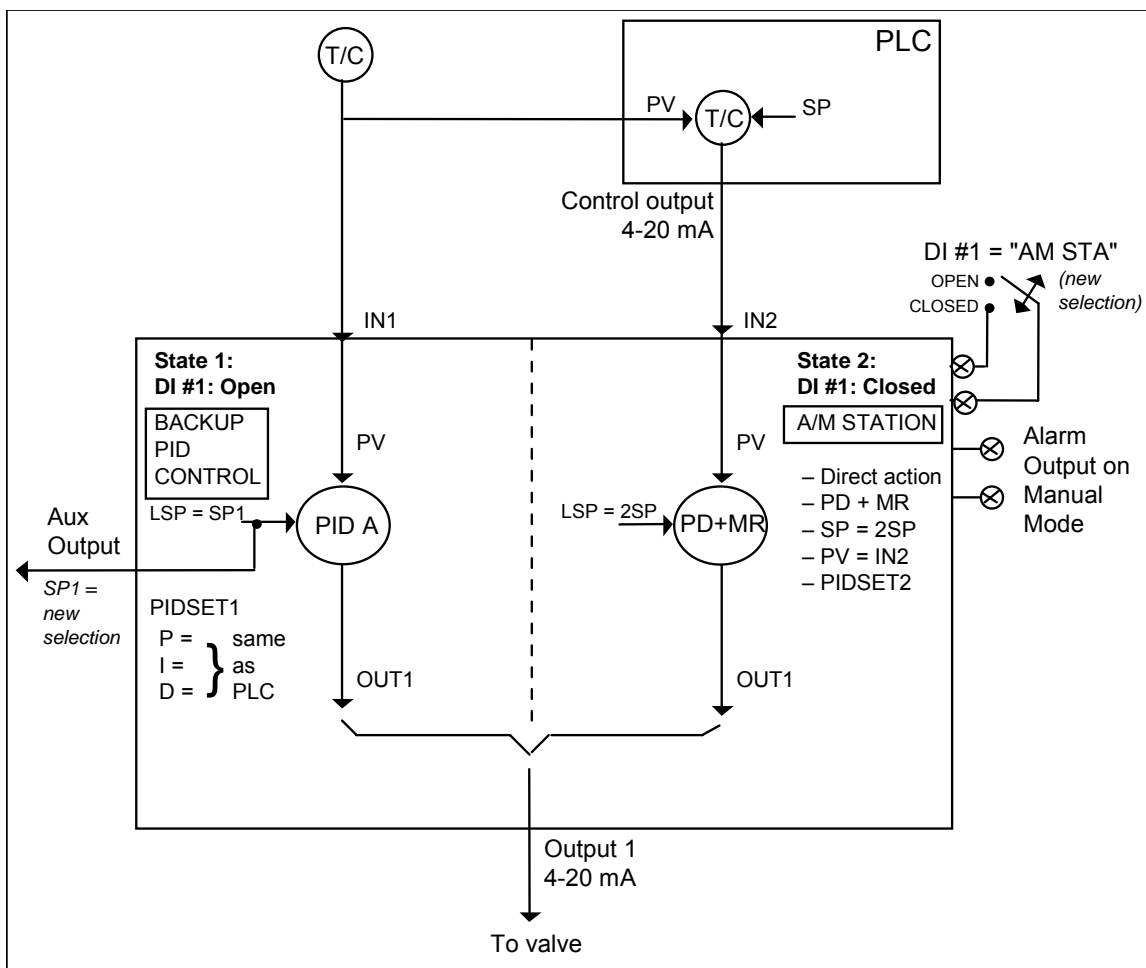

Figure 4-2 Auto/Manual Station for Loop 1 (Loop 2 similar)

Description

The “AM STA” selection of digital input creates a repeater station when the digital input is closed. This is accomplished by a multi-selection from the digital input menu.

- “ACTION” is forced as “DIRECT”.
- “CONT ALG” is forced as “PD+MR”.
- Active setpoint is forced to 2SP.
- The Loop 1 PV is switched to “PV 2IN” for Loop 1.
- The Loop 2 PV is switched to “PV 3IN” for Loop 2.
- The tuning parameters used are the second set of parameters.

When the switch is open the unit becomes a normal controller with “CONT ALG” of “PID A”, using tuning parameters set 1, SP, PV as IN1 and “DIRECT” or “REVERSE” as selected by customer configuration.

Input 1 is typically the PV of some upper controller and Input 2 is typically that controller’s output. If the upper control fails, the upper device or some watchdog opens the digital input switch and UDC3500 back-up PID A control is active.

When the upper control reactivates, the digital input switch is closed and the Auto/Manual Station becomes a repeater station and allows the upper control output signal to pass through.

Configuration

There are some things to consider when configuring the controller.













The PV range stays as the IN1 range, even while IN2 is the PV when the switch is closed; therefore:









- The IN2 HI must be less than or equal to the IN1 HI.
(Suggest: IN2 HI = 100.0)
- The IN2 LO must be greater than or equal to the IN1 LO.
(Suggest: IN2 LO = 0.0)
- The TUNING GAIN2 must be equal to $(IN1\ HI - IN1\ LO) / (IN2\ HI - IN2\ LO)$.

See Table 4-22 for Configuration Procedure.

Table 4-22 Auto/Manual Station Mode Configuration Procedure

Step	Operation	Press	Result
1	Select Algorithm Set-up Group	Setup	Until you see: <i>Upper Display</i> = SET <i>Lower Display</i> = ALGORTHM
2	Select Control Algorithm	Func Loop 1/2	Until you see: <i>Upper Display</i> = (available selections) <i>Lower Display</i> = CONT ALG

Step	Operation	Press	Result
3	Select PD + Manual Reset Function	 or 	To select PD+MR — PD + Manual Reset
4	Select Control Set-up Group	Setup	Until you see: <i>Upper Display</i> = SET <i>Lower Display</i> = CONTROL
5	Select PID SETS	Func Loop 1/2	Until you see: <i>Upper Display</i> = (available selections) <i>Lower Display</i> = PID SETS
6	Select PID SETS Function	 or 	To select 2KEYBD —2 sets, keyboard selectable
7	Select LSP'S	Func Loop 1/2	Until you see: <i>Upper Display</i> = (available selections) <i>Lower Display</i> = LSP'S
8	Select LSP'S Function	 or 	To select TWO —Two LSP's
9	Select SP TRACK	Func Loop 1/2	Until you see: <i>Upper Display</i> = (available selections) <i>Lower Display</i> = SP TRACK
10	Select SP TRACK Function	 or 	To select NONE —No SP Tracking
11	Select Tuning Set-up Group	Setup	Until you see: <i>Upper Display</i> = SET <i>Lower Display</i> = TUNING
12	Select Manual Reset Value	Func Loop 1/2	Until you see: <i>Upper Display</i> = (available selections) <i>Lower Display</i> = MAN RSET
13	Configure Manual Reset Value	 or 	To configure: 0 — Manual Reset Value A Manual Reset of 0 is for no output bias and requires that LSP2 = 0 % of the Setpoint Range. If bias is required, set the Manual Reset value to equal the desired output bias value.
14	Select Algorithm Set-up Group	Setup	Until you see: <i>Upper Display</i> = SET <i>Lower Display</i> = ALGORTHM
15	Select Control Algorithm	Func Loop 1/2	Until you see: <i>Upper Display</i> = (available selections) <i>Lower Display</i> = CONT ALG
16	Select PID A	 or 	To select: PID A — PID A This is defining the back-up control algorithm.

Step	Operation	Press	Result
17	Select Tuning Set-up Group	Setup	Until you see: <i>Upper Display</i> = SET <i>Lower Display</i> = TUNING
18	Configure PIDSET 1 Values	Func Loop 1/2 and  or 	Configure the PIDSET 1 tuning parameters as needed by the application.
19	Select Gain 2 Value	Func Loop 1/2	Until you see: <i>Upper Display</i> = (available selections) <i>Lower Display</i> = GAIN2
20	Configure Gain 2 Value	 or 	Set the Gain 2 equal to: $\frac{\text{Input 1 Span}}{\text{Input 2 Span}}$ If "PB" is selected under the Control Set Up group function prompt "PBoRGAIn", then set the PROP BD2 to $100 \times \frac{\text{Input 2 Span}}{\text{Input 1 Span}}$
21	Select Rate 2 Min Value	Func Loop 1/2	Until you see: <i>Upper Display</i> = (available selections) <i>Lower Display</i> = RATE2MIN
22	Configure Rate 2 Min Value	 or 	To configure: 0.00
23	Select Options Set-up Group	Setup	Until you see: <i>Upper Display</i> = SET <i>Lower Display</i> = OPTIONS
24	Select a Digital Input	Func Loop 1/2	Until you see: <i>Upper Display</i> = (available selections) <i>Lower Display</i> = DIG IN1 or DIG IN2 or DIG IN3 or DIG IN4 This selection determines which Digital Input will be used for Auto-Manual Station operation.
25	Select which loop the Digital Input acts on	Dion LP2	When using A/M on Loop 1, this selection is not necessary. When using A/M on Loop 2, configure this selection for whichever Digital Input you selected in the previous step.
26	Select Auto-Manual Station Function	 or 	To select: AM STA — Auto-Manual Station

CAUTION DO NOT SELECT

- In the CONTROL set up list, do not select SP TRACK as PV or RSP.
- In the SP RAMP set up list, do not select SP RATE as ENABLE.
- In the ALGORITHM set up list, do not select CONT ALG as PID B, ON-OFF, or 3PSTEP.
- In the Display menu when PIDSET # is displayed, DO NOT change the selection.

Operation

Operate the Auto/Manual Station as follows:

Set the Local Setpoint 2 to 0 % of the Input 2 range.

These features work with the Auto/Manual Station.

- In the SP RAMP set up list, SP PROG (acts on SP1 for backup operation).
- In the SP RAMP set up list, SP RAMP (acts on SP1 for backup operation).
- In the CONTROL set up list, ACTION as DIRECT or REVERSE for the backup PID A operation.
- The PD+MR action is forced to be DIRECT as required for the pass through of the output signal.

4.17 Two Loops of Control

Introduction

As an option, this instrument can operate using two independent loops of control or internal Cascade Control.

Two Independent Loops

See Functional Overview Block Diagrams for Loop 1 and Loop 2 (Figure 4-3) for selections based on these diagrams.

The following rules apply for two independent loops:

- Control and Alarm Outputs are allocated per Table 2-6 and Table 2-7.
- Current output on Loop 2 requires that either Second Current Output or Third Current Output be installed.
- Loop 2 relay output is always dedicated to relay outputs 3 and 4.
- No Three Position Step output on Loop 2.

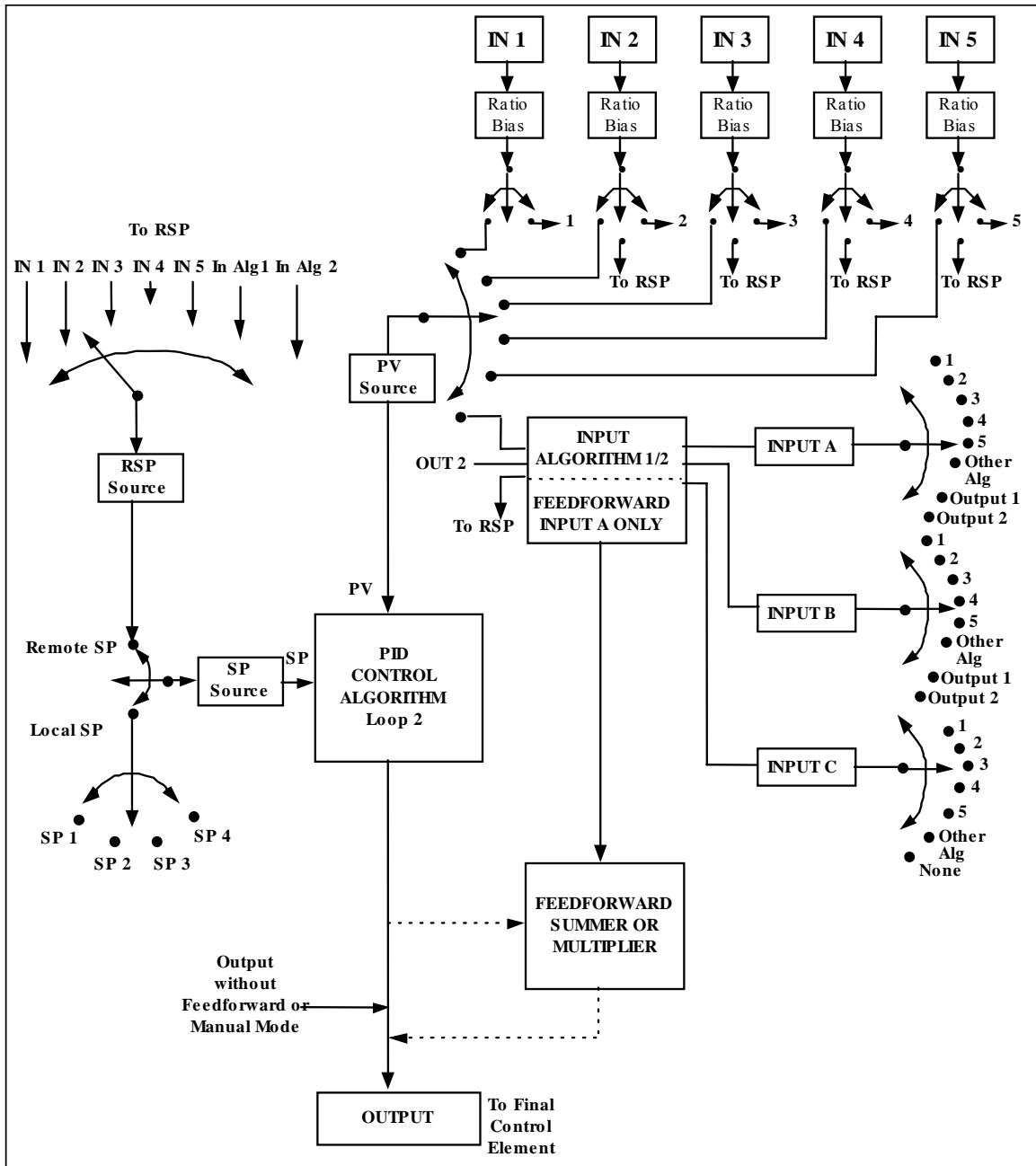

Figure 4-3 Functional Overview Block Diagram of a Single Loop (Loop #1) or Dual Loop Controller (Loop #1 and Loop #2)

Internal Cascade Control

See Functional Overview Block Diagram Figure 4-3 for selections based on these diagrams.

The following rules apply for internal Cascade control:

- Loop 2 is the primary (external) loop.
- Loop 1 is the secondary (internal or slave) loop.
- Loop 1 Remote Setpoint is fixed as the Loop 2 output.

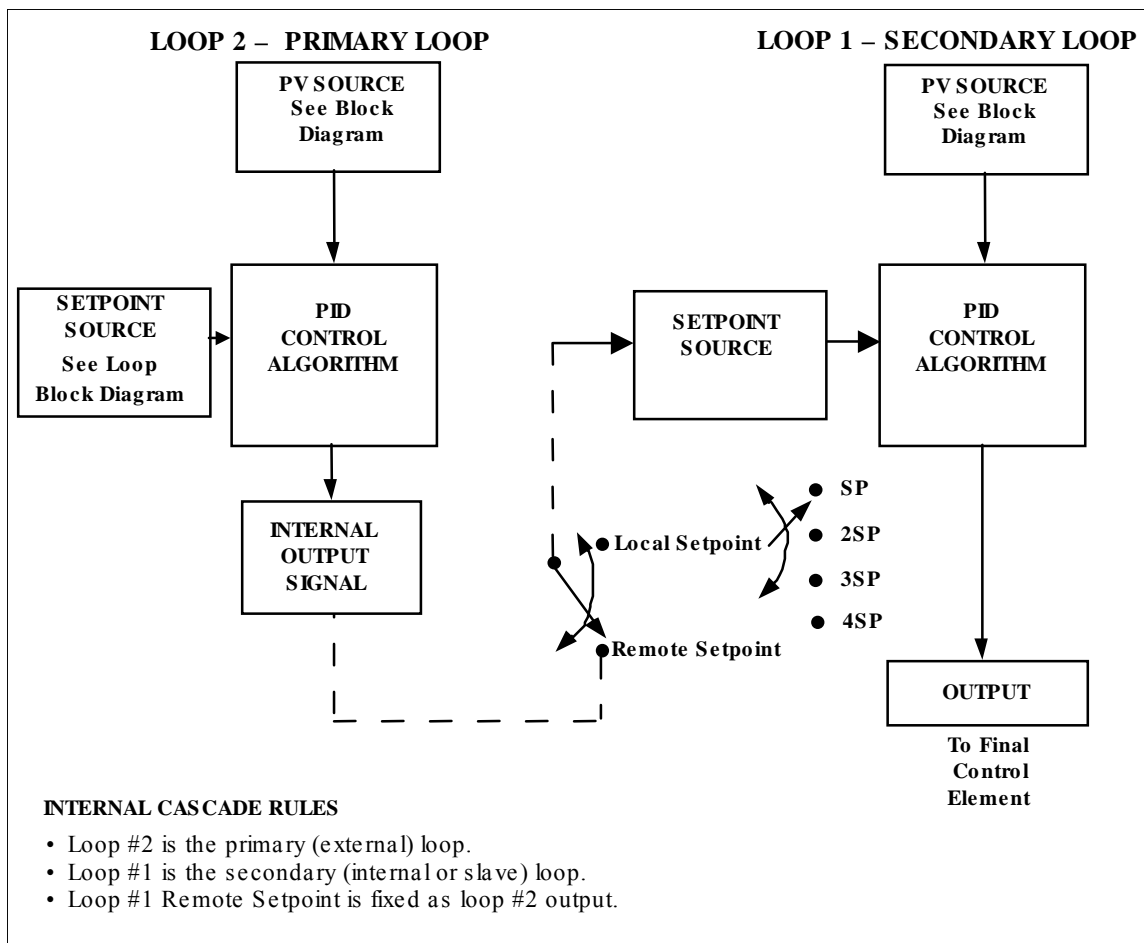

Figure 4-4 Functional Overview Block Diagram of Internal Cascade Controller

Output Override

This instrument allows override of the Loop 1 output with the Loop 2 output based upon which is larger or smaller. This can be accomplished by configuration (See Section 3.11) or by Digital Input actuation (see Section 3.22).

The following rules apply for high/low override:

- Only one physical output is required when override is enabled. It is the output from Loop 1 because Loop 2's internal output is routed through the selector.
- Loop 2 output can also be available at all times if desired.
- In Manual mode, the Output may be overridden.
- Does not apply for Three Position Step Control.
- OTI on bottom display shows value of the internal Loop 1 output before any override.

ATTENTION

The output of the unselected loop tracks the selected loop to within 5 % when in Auto mode to eliminate windup. This tracking is done in the direction opposite to the Override Select configuration; i.e., for High Select, the unselected output tracks within 5 % of the lower output, and vice versa for Low Select.

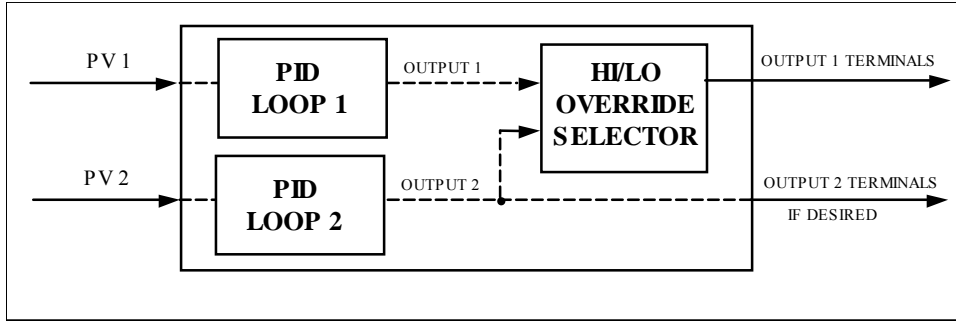

Figure 4-5 Hi/Lo Override Selector

4.18 Configuring Two Loops of Control

Introduction

This instrument can operate using two independent loops of control or internal Cascade control.

Table 4-23 Procedure for selecting Two Loop Algorithm

Step	Operation	Press	Result
1	Select Algorithm Set-up Group	Lower Display	Until you see: <i>Upper Display = SET</i> <i>Lower Display = ALGORITHM</i>
2	Select the PID Loops	Func Loop 1/2	Until you see: <i>Upper Display = (available selections)</i> <i>Lower Display = PIDLOOPS</i>
2		▲ or ▼	To change selection
3		Lower Display	To accept changes.

4.19 Monitoring Two Loops of Control

Introduction

Monitoring two individual loops of control or internal Cascade is similar as for a single loop with the following additions.

Table 4-24 Digital Display Indication—Two Loops

Indicator	Loop Indication	Definition
<p>none (two-loop)</p> <p>I (cascade)</p>	Loop 1	<ul style="list-style-type: none"> • Upper display shows the Process Variable (PV) for Loop 1 • Lower display shows the Loop 1 parameters and the PV and Output for Loop 2 • Controller setpoint annunciators show the setpoint currently being used for Loop 1
L”	Loop 2	<ul style="list-style-type: none"> • Upper display shows the Process Variable (PV) for Loop 2 • Lower display shows the Loop 2 parameters and the PV and Output for Loop 1 • Controller setpoint annunciators show the setpoint currently being used for Loop 2

Loop Display

Display of Loop 1 or Loop 2 (if configured) is selected by toggling the **Func-Loop1/2** key.

Viewing each Loop’s Process Variable

Regardless of which loop is being displayed, 1 or 2, the process variable of the non-displayed loop can be shown in the lower display by repeated presses of the **Lower Display** key until **1PVXXXX** or **2PVXXXX** is displayed.

Internal Cascade Indication

When internal Cascade has been configured, an “I” will appear on the left side of the upper display as long as Loop 1 is operating in the remote setpoint mode. Hold in the **SP Select** key until RSP appears in the lower display then release the key to select remote setpoint.

Switching between automatic and manual mode on either loop will not affect the internal Cascade indication.

4.20 Operating Two Loops of Control

Introduction

Operation of two individual loops of control is identical to operating a single loop of control except that TUNING 2 group applies to Loop 2 only and four PID sets, 5 through 8, are available. TUNING group applies to Loop 1 with PID sets 1 through 4 applicable.

Operating modes and setpoint source

The rules for Auto/Manual modes and changing setpoint sources are the same as single loop operation.

Keyboard operation

Note that the loop being displayed is the only loop affected by normal keyboard operation. However, either loop can be reconfigured when in the Set Up mode regardless of which is being displayed during normal operation.

Accutune III

Two independent loops or cascaded loops can be tuned at the same time, if so configured.

Setpoint Ramp or SP Programming

Either loop or both loops can be configured for a single setpoint ramp operation by enabling the desired loop or loops (see Section 3 – Configuration)

An “H” or “R” will appear in the upper display when applicable, depending upon which loop is being displayed.

Digital Inputs (remote mode switching)

Digital Input 1 is dedicated to Loop 1 when two loops or Cascade control is configured. The other digital inputs may be configured to work on either loop.

Output Override Hi/Lo select

Output Override allows you to select the higher of Output 1 and Output 2 (Hi Select) or the lower of Output 1 and Output 2 (Lo Select) to appear at Output 1 terminals to drive the final control element. Refer to Section 5.12 for Override rules and block diagram.

Override prompts appear under the Algorithm Set Up group, function prompt OUT OVRD.

4.21 Alarm Setpoints

Introduction

An alarm consists of a relay contact and an operator interface indication.

During normal operation, alarm relays in the inactive state (no alarm condition exists) will have their Normally Open (NO) contacts closed. Alarm relays in the active state (alarm condition exists) will have their Normally Closed (NC) contacts closed. See Table 2-3 in the *Section 2 – Installation* for alarm relay contact information. This means that the alarm relays are designed to operate in a failsafe mode (that is, the relay coil is de-energized – NC contacts are closed – when an alarm is active). If power is lost to the unit, the alarms will de-energize and thus the alarm contacts will close.



When power is first applied to the instrument, all alarm relays will remain in the de-energized state until the instrument completes its self-diagnostic routine. The alarms relays will then energize or remain de-energized, depending upon their configuration and their monitored parameter.

There are eight alarm setpoints, two for each alarm. The type and state (High or Low) is selected during configuration. See *Subsection 3.24 – Configuration* for details.

Alarm Setpoints Display

Table 4-25 Procedure for Displaying Alarm Setpoints

Step	Operation	Press	Result
1	Select Alarm Set-up Group	Setup	Until you see: <i>Upper Display = SET</i> <i>Lower Display = ALARMS</i>
2	Access the Alarm Setpoint Values	Func Loop 1/2	To successively display the alarm setpoints and their values. Their order of appearance is shown below. <i>Upper Display = (the alarm setpoint value)</i> <i>Range values are within the range of the selected parameters except:</i> DEVIATION (DEV) value = PV Span EVENTS (EV-ON/EV-OFF) value = Event Segment Number PV RATE OF CHANGE (PVRATE) = The amount of PV change in one minute in engineering units. LOOP BREAK ALARMS (BREAK) = The timer value may be changed only for controllers configured for ON/OFF control. <i>Lower Display = A1S1 VAL = Alarm 1, Setpoint 1 Value</i> <i>A1S2 VAL = Alarm 1, Setpoint 2 Value</i> <i>-----</i> <i>A4S2 VAL = Alarm 4, Setpoint 2 Value</i> NOTES: <i>With Three position step control, alarms set for “output” will not function.</i> <i>MANUAL, RSP, and F’SAFE selections do not have setpoint values.</i>

Step	Operation	Press	Result
3	Change a value	 or 	To change any alarm setpoint value in the upper display.
4	Return to Normal Display	Lower Display	

Setpoint Programming Event Alarms

An alarm setpoint can be configured to turn on or turn off an alarm based upon a particular segment in a Setpoint Program.

Using Alarm 1 Setpoint 1 as an example:

If Alarm 1 Setpoint1 Value (**A1S1 VAL**) is configured for Segment 5, Alarm 1 Setpoint 1 Type (**A1S1TYPE**) is configured for Event On (**EV ON**) and Alarm 1 Segment 1 Event (**A1S1 EV**) is configured for BEGIN, then this alarm will activate when the Setpoint Program reaches the beginning of Segment 5.

ATTENTION If no other alarm configuration turns this alarm off after the above configuration has turned it on, then when the Setpoint Program is configured to be disabled when the Setpoint Program ends, this alarm will stay on.

If Alarm 1 Setpoint1 Value (**A1S1 VAL**) is configured for Segment 5, Alarm 1 Setpoint 1 Type (**A1S1TYPE**) is configured for Event Off (**EV OFF**) and Alarm 1 Segment 1 Event (**A1S1 EV**) is configured for END, then this alarm will deactivate when the Setpoint Program reaches the end of Segment 5.

ATTENTION Some other alarm configuration must first turn the alarm on before this configuration can turn it off.

4.22 Three Position Step Control Algorithm

Introduction

The Three Position Step Control (TPSC) algorithm allows the control of a valve (or other actuator) with an electric motor driven by two controller output relays; one to move the motor upscale, the other to move it downscale, without a feedback slidewire linked to the motor shaft.

Estimated Motor Position

The Three Position Step control algorithm provides an output display, which is an estimated motor position since there is no slidewire feedback.

- Although this output indication is only accurate to a few percent, it is corrected each time the controller drives the motor to one of its stops (0 % or 100 %).
- It avoids all the control problems associated with the feedback slidewire (wear, dirt, and noise).
- When operating in this algorithm, the output display is shown to the nearest percent (that is, no decimal).

The Motor Travel Time (the time it takes the motor to travel from 0 % to 100 %) must be configured in order for TPSC to operate correctly. See Section 3.14.

Motor Position Display

Table 4-26 Procedure for Displaying TPSC Motor Position

Step	Operation	Press	Result
1	Access the Displays	Lower Display	Until you see: <i>Upper Display = PV</i> <i>Lower Display = OT (The estimated motor position in %)</i>

Accurate Motor Position

In the event that an accurate and repeatable indication of motor position is required, the instrument's Third Analog Input may be used to read the motor's slidewire. The Third Analog Input must be configured for slidewire operation. Motor position is then shown on the lower display as POS XX.X. The TPSC algorithm does not use this value; it is only used for display purposes.

The slidewire must be calibrated for this display to operate correctly. See Section 6.5.



4.23 Setting a Failsafe Output Value for Restart after a Power Loss

Introduction

If the power to the controller fails and power is reapplied, the controller goes through the power up tests, then goes to a user configured FAILSAFE OUTPUT VALUE.

Set a Failsafe Value

Table 4-27 Procedure for Setting a Failsafe Value

Step	Operation	Press	Result
1	Select Control Set-up Group	Setup	Until you see: <i>Upper Display = SET</i> <i>Lower Display = CONTROL</i>
2	Select Failsafe Function Prompt	Func Loop 1/2	You will see: <i>Upper Display = (range)</i> <i>within the range of the Output 0 to 100 for all output types except Three Position Step</i> Three Position Step <i>0 = motor goes to closed position</i> <i>100 = motor goes to open position</i> <i>Lower Display = F'SAFE</i>
3	Select a value	 or 	To select a failsafe output value in the upper display
4	Return to Normal Display	Lower Display	At power up, the output will go to the value set.



4.24 Setting Failsafe Mode

Introduction

You can set the Failsafe Mode to be Latching or Non-Latching.

Set Failsafe Mode

Table 4-28 Procedure for Setting a Failsafe Mode

Step	Operation	Press	Result
1	Select Control Set-up Group	Setup	Until you see: <i>Upper Display</i> = SET <i>Lower Display</i> = CONTROL
2	Select Failsafe Function Prompt	Func Loop 1/2	You will see: <i>Upper Display</i> = LATCH (Controller goes to manual and output goes to failsafe value) NoLATCH (Controller mode does not change and output goes to failsafe value) <i>Lower Display</i> = FSMODE
3	Select a value	 or 	To select a failsafe mode in the upper display.
4	Return to Normal Display	Lower Display	At power up, the output will go to the value set.

4.25 Carbon Potential, Oxygen and Dewpoint Algorithms

Introduction

Carbon probes can be used to control Carbon Potential, Percent Oxygen or Dewpoint applications by configuring the Input Algorithm 1 for the desired type.

Most carbon probes consist of a zirconium oxide (ZrO_2) sensor and a thermocouple (to measure the temperature at the ZrO_2 sensor). These probes generally have four wires, two for the ZrO_2 sensor and two for the thermocouple. The ZrO_2 sensor is connected to Input 1 on this controller while the thermocouple is connected to Input 2. Input 1 actuation is automatically set to Carbon when any Carbon Potential Algorithm is configured, to Oxygen when the Oxygen Algorithm is configured, and to Carbon when the Dewpoint Algorithm is configured. The thermocouple in these probes is normally a K, R or S thermocouple type. However, Input 2 can be configured for any input actuation for applications where some other temperature sensor is used. PV Source in the Control Set Up Group should be configured to IN ALG 1.

Instruments with Two Loops may use Loop 1 to control the Carbon/Oxygen/Dewpoint of the oven while Loop 2 may use the temperature measured by Input 2 to control the temperature of the oven. For this application, PV Source in the Control Set Up Group

should be configured to IN ALG 1 while PV Source in the Control 2 Set Up Group should be configured to INPUT 2.

See Section 3.11 for configuration and other information.

Features

- Direct calculation of carbon percentage with seven different manufacturers' probes:
 - Advanced Atmosphere Control Corporation (AACC)
 - Corning
 - Cambridge Instruments
 - Marathon Monitors
 - Furnace Control Corporation
 - MacDhui (Barber Colman)
 - Bricesco
- ± 0.02 % accuracy
- No nomographs—no mistakes
- Probe temperature input type is selectable from complete input menu.
- Four different local setpoints—standard feature
- Duplex control with second set of PID constants for dilution air control
- Process factor adjustment capability
- Automatic sooting warning via flashing display and configurable alarm
- Carbon Potential Algorithms, PV Range: 0.0 to 2.0 % (0.1 to 1.4 % for specified accuracy)
- Dewpoint Algorithm, PV Range: -50 °F to $+100$ °F (-45 °C to 38 °C)
- % Oxygen Algorithm, PV Range: 0 % to 40 %
- Second Control Loop can use the temperature input to control furnace temperature

Carbon Potential

The percent Carbon Monoxide (CO) content of the enriching gas may be entered as a fixed value or Input 3 on the controller may be used to measure CO content as a live value provided by a separate sensor.

All calculations are performed by the Controller with Percent Carbon shown as the PV display. The actual reading of each analog input is available for viewing on the lower display.

The controller computes the atmosphere's actual carbon potential from these inputs and compares the computed value with the desired setpoint. An on-off or PID control algorithm determines the controller output necessary to keep the actual carbon potential at the setpoint.

Usually only one output is used to add more or less enriching gas (typically natural gas) to the furnace's base atmosphere, which has a relatively low carbon potential. The enriching gas then raises the carbon potential to the desired level. There are occasions when it is desirable to use dilution air in order to lower the carbon potential instead of enriching gas to raise it. In those instances, a second output from the controller can provide this function by configuring duplex control. When duplex proportional control is used, a different set of PID tuning constants is used for the dilution air than those used for the enriching gas.

Although the temperature used for these Carbon algorithms is normally a live value read by Input 2, it may also be configured as a fixed value. The fixed value selection is useful for when an Automotive Sensor is used, as these do not contain a thermocouple sensor.

Carbon Potential Diagram

Figure 4-6 illustrates a typical application for carbon potential control.

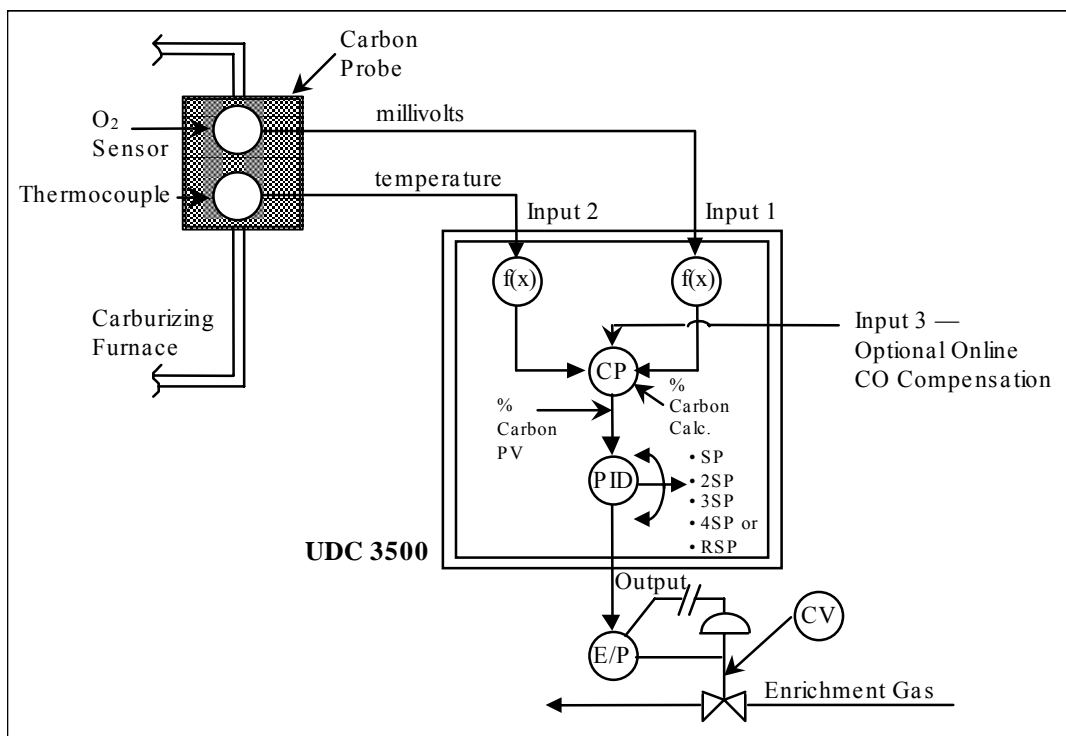

Figure 4-6 Carbon Potential Control

Percent Oxygen

Percent Oxygen control requires two analog inputs. Input 1 actuation is automatically set to Oxygen when the Percent Oxygen Algorithm is configured. Input 2 may be any input actuation, but it is normally a type K, R or S thermocouple input.

All calculations are performed by the Controller with Percent Oxygen shown as the PV display. The actual reading of each analog input is available for viewing on the lower display.

Dewpoint

The Dewpoint Algorithm is used for controlling the Dewpoint in endothermic atmospheres. Furnace Control's Accucarb ZrO₂ sensor is used on Input 1. Input 1 actuation is automatically set to Carbon when the Dew Point Algorithm is configured. Input 2 may be any input actuation, but it is normally a type K, R or S thermocouple input.

The percent Hydrogen (H₂) atmospheric content is entered as a fixed value.

All calculations are performed by the Controller with the Dewpoint temperature shown as the PV display. The actual reading of each analog input is available for viewing on the lower display.

The availability of Dewpoint on Input Algorithm 2 provides the capability of controlling Carbon Potential on Loop 1 while also being able to calculate the Dewpoint value from the same probe. For this configuration, "DEW XX.X" may be viewed on the lower display, where "XX.X" is the Dewpoint temperature.

4.26 Healthwatch

Introduction

The Healthwatch feature puts diagnostic data at your fingertips so you can monitor vital performance status to improve your process, predict failures, and minimize downtime.

Valuable data regarding maintenance and diagnostic selections can be read by operator-accessed displays. Alarms can be configured to activate when the desired threshold is reached.

See *Section 4.18 Maintenance* for details on using the various Healthwatch timers and counters. See *Section 4.15 Alarms* for details on Healthwatch maintenance alarms.

4.27 Setpoint Rate/Ramp/Program Overview

Introduction

The Setpoint Ramp configuration group lets you enable and configure any of the following:

- **SP RATE** – a specific rate of change for any local setpoint change. (Subsection 4.28)
- **SP RAMP** – a single setpoint ramp that occurs between the current local setpoint and a final local setpoint over a time interval of 1 to 255 minutes. (Subsection 4.29)
- **SP PROG** – a ramp/soak profile in a 20-segment program. (Subsection 4.30)

This section explains the operation of each selection and configuration reference where necessary.

PV Hot Start

This is a standard feature. At power-up, the setpoint is set to the current PV value and the Rate or Ramp or Program then starts from this value.

RUN/HOLD key

You can start or stop the Ramp or Program using the RUN/HOLD key.

4.28 Setpoint Rate

Introduction

When you have configured a SETPOINT RATE, it will apply immediately to local setpoint change.

Configuration check

Make sure:

- SPRATE is enabled
- A Rate Up (EUHRUP) or Rate Down (EUHRDN) value has been configured in Engineering units per hour.

ATTENTION

A value of 0 will imply an immediate change in setpoint, that is, NO RATE applies. See Subsection 3.6 – Configuration group “SPRAMP” for details.)

Operation

When a change to local setpoint is made, this controller will ramp from the original setpoint to the “target” setpoint at the rate specified.

The current setpoint value is shown as **SPn XXXX** on the lower display while the “target” setpoint is shown as **SP XXXX** on the lower display.

Power outages

If power is lost before the “target” setpoint is reached, upon power recovery, the controller powers up with Sn = Current PV value and it automatically “Restarts” from Sn = current PV value up to the original “target” setpoint.

4.29 Setpoint Ramp

Introduction

When you have configured a SETPOINT RAMP, the ramp will occur between the current local setpoint and a final local setpoint over a time interval of from 1 to 255 minutes. You can RUN or HOLD the ramp at any time.

Configuration Check

Make sure

- SPRAMP is enabled
- SP RATE and SPPROG are not running.
- A Ramp Time (TIMIN) in minutes has been configured
- A final setpoint value (FINLSP) has been configured. See Subsection 3.6 – Configuration group “SPRAMP” for details.

Operation

Running a Setpoint Ramp includes starting, holding, viewing the ramp, ending the ramp and disabling it. See Table 4-29.

Table 4-29 Running A Setpoint Ramp

Step	Operation	Press	Result
1	Select Automatic Mode	Man/Auto	“A” indicator is on. <i>Upper Display</i> = “H” and PV value <i>Lower Display</i> = SP and Present value
2	Set Start Setpoint	Lower Display	Until start SP value is in lower display <i>Upper Display</i> = “H” and PV value <i>Lower Display</i> = SP and start SP value
3	Start the Ramp	Run/Hold	You will see <i>Upper Display</i> = “R” and a changing PV value <i>Lower Display</i> = SP and a changing SP value increasing or decreasing toward the final SP value
4	Hold/Run the Ramp	Run/Hold	This holds the ramp at the current setpoint value. Press again to continue.
5	View the remaining ramp time	Lower Display	Until you see <i>Upper Display</i> = PV value <i>Lower Display</i> = RAMPXXXM (time remaining in minutes)
6	End the Ramp		When the final setpoint is reached, “R” changes to “H” in the upper display and the controller operates at the new final setpoint.
7	Disable SPRAMP		See Section 3 – Configuration group “SPRAMP” for details.

Power Outage

If power is lost during a ramp, upon power-up the controller will be in HOLD and the setpoint value will be the setpoint value prior to the beginning of the setpoint ramp.

The ramp is placed in hold at the beginning.

Configure the mode at Set Up Group “CONTROL”, function prompt “PWR MODE”. See Subsection 3.20 – CONTROL SETUP GROUP Prompts.

4.30 Setpoint Ramp/Soak Programming

Introduction

The term “programming” is used here to identify the process for selecting and entering the individual ramp and soak segment data needed to generate the required setpoint versus time profile (also called a program).

There are new features in this group that do not appear in previous NGC products:

- Up to Four SP Programs rather than one
- 20 segments instead of 12 in each program
- SP Programs 1 and 2 can be linked to give a SP Program of up to 40 segments
- SP Programs 3 and 4 can be linked to give a SP Program of up to 40 segments
- Guaranteed Soak Settings for each Soak Segment
- PID Set selection for each Segment

A segment is a ramp or soak function which together make up a setpoint program. Setpoint Ramp/Soak Programming lets you configure 10 ramp and 10 soak segments to be stored for use as one program or several small programs. You designate the beginning and end segments to determine where the program is to start and stop.

ATTENTION

Please note that the configurations used in SP Program #1 for Program End, Program State, Power Up and Key Reset affect all other SP Programs. For this reason, Program #1 must always be enabled in order to enable Programs #2, 3 and/or 4.

Review program data and configuration

While the procedure for programming is straightforward, and aided by prompts, we suggest you read “Program Contents”. Table 4-30 lists the program contents and an explanation of each to aid you in configuration. Then refer to Subsection 3.6– Configuration to do the setpoint program.

Make sure SPRAMP is disabled.

Fill out the worksheet

Refer to the example in Figure 4-7. For each SP Program, draw a Ramp/Soak Profile on the worksheets provided and fill in the information for each segment. This will give you a record of how the programs were developed.

Operation

Refer to Table 4-36 Run/Monitor the program.

Program Contents

Table 4-30 lists all the program contents and a description of each.

Table 4-30 Program Contents

Associated Prompts	Contents	Definition
STRT SEG	Start segment number	The start segment number designates the number of the first segment. Range = 1 to 19
END SEG	End segment number	The end segment number designates the number of the last segment; it must be a soak segment (even number). Range = 2 to 20
RECYCLES	Recycle number	The recycle number allows the program to recycle a specified number of times from beginning to end. Range = 0 to 99
STATE	Program state	The program state selection determines the program state after completion. The selections are: <ul style="list-style-type: none"> • DISABLE = program is disabled (so program value changed to DISABLE) • HOLD = program on hold
PROG END	Program termination state	The program termination state function determines the status of the controller upon completion of the program. The selections are: <ul style="list-style-type: none"> • LAST = controls to last setpoint • FAILSAFE = manual mode and failsafe output.
POWER OUT	Program state after a power outage	This configuration determines what the Program will do in the case of a power outage during the Program. This prompt only appears on those instruments that have the Real Time Clock option. The selections are: <ul style="list-style-type: none"> • ABORT = Program terminated on power up. Instrument controls per the PROG END configuration. • RESUME = Continue at the same point in segment and cycle where power was lost. • RESTART = Restart program at the beginning of the first program segment in the same cycle where power was lost.
KEYRESET (ToBEGIN)	Reset Program to Beginning	When enabled, this selection allows you to reset via the keyboard to the beginning of the program and resets the Recycle value to 0. The program mode is placed in HOLD. If the current Local Setpoint 1 value is at any value other than that Setpoint value used in the first Soak segment in the program, then the program will restart at the current Local Setpoint 1 value and at the beginning of the first Ramp segment in the program. If the current Local Setpoint 1 value is at the same Setpoint value as that used for the first Soak segment in the program, then the first Ramp segment is skipped and the program will restart at the beginning of the first Soak segment in the

Associated Prompts	Contents	Definition
		program.
KEYRESET (RERUN)	Rerun current cycle	RERUN CURRENT CYCLE —When enabled, this selection allows you to reset the program via the keyboard to the beginning of the current cycle. The Recycle value is not affected. The program mode (RUN or HOLD) is not affected.
HOTSTART	Hot Start	<p>This function determines whether LSP1 or PV is used as the setpoint when the program is initially changed from HOLD to RUN. The selections are:</p> <p>DISABLE = When the program is initially changed from HOLD to RUN the present LSP1 value is captured as the default setpoint. If the program is terminated or the power cycled before the program has completed, the LSP1 is used as the control setpoint. The beginning segment uses this value as the initial ramp setpoint.</p> <p>ENABLE = When the program is initially changed from HOLD to RUN the present PV value is captured and used as the beginning setpoint value for the ramp segment. If the program is terminated before completion, the setpoint value will revert back to the PV value captured at the initial HOLD to RUN transition. If the power is cycled before program completion, upon power-up the setpoint is set to the PV value at power-up and when the program is restarted that setpoint value is used initially.</p>
RAMPUNIT SEGxRAMP or SEGxRATE	Ramp time or rate segments	<p>A ramp segment is the time it will take to change the setpoint to the next setpoint value in the program.</p> <p>Ramps are odd number segments (1, 3, . . . 19). Segment #1 will be the initial ramp time.</p> <p>Ramp time is determined in either:</p> <p style="padding-left: 40px;">TIME - Hours.Minutes Range = 0-99hr.59 min.</p> <p style="text-align: center;">or</p> <p style="padding-left: 40px;">RATE - EU/MIN or EU/HR Range = 0 to 999</p> <p>This selection of time or rate is made at prompt "RAMPUNIT".</p> <p>Set this prompt before entering any Ramp values.</p> <p>ATTENTION Entering "0" implies an immediate step change in setpoint to the next soak.</p>

Associated Prompts	Contents	Definition
SEGx SP SEGxTIME	Soak segments	<p>A soak segment is a combination of soak setpoint (value) and a soak duration (time).</p> <ul style="list-style-type: none"> • Soaks are even number segments (2, 4, . . . 20). • Segment 2 will be the initial soak value and soak time. • The soak setpoint range value must be within the setpoint high and low range limits in engineering units. • Soak time is the duration of the soak and is determined in: TIME – Hours:Minutes Range = 0-99 hr:59 min.
SEGX PID	PID Set	<p>These prompts will appear only when the number of PID sets selected in the Control or Control 2 Setup Group is set to 4KEYBD. Each Ramp and Soak segment may select a specific PID set. A Setpoint Program enabled only for Loop 1 will use Loop 1 PID Sets. A Setpoint Program enabled only for Loop 2 will use Loop 2 PID Sets. A Setpoint Program enabled for both Loop 1 and Loop 2 will use Loop 1 PID Sets.</p> <p>Range: PID Set 1 to 4</p>
SOAK2DEV <i>through</i> SOAK20DEV	Guaranteed Soak Deviation Value	<p>Each individual soak segment can have a unique guaranteed deviation value of from 0.000 to ± 99.99 in engineering units.</p> <p>Guaranteed Soak deviation values greater than zero ensure that the soak segment's process variable is within the \pm deviation value for the configured soak time. Whenever the \pm deviation value is exceeded, the soak timer stops until the process variable gets within the \pm deviation value. While the soak timer is halted, "R" and "H" will alternate in the upper display. When the PV gets within the \pm deviation value, the timer will resume and a steady "R" will appear in the upper display.</p> <p>There are no guaranteed soaks whenever the deviation value is configured to 0.00 (that is, soak segments start timing soak duration as soon as the soak setpoint is first reached, regardless of where the process variable remains relative to the soak segment).</p> <p>The decimal location used here corresponds decimal configuration chosen in the Display Set up group.</p>

Ramp/soak profile example

Before you perform the actual configuration, it is recommended that you draw a Ramp/Soak profile in the space provided for each of the “*Program Record Sheets*” and fill in the associated information in the associated Tables. An example of a Ramp-Soak Profile is shown in Figure 4-7 and Table 4-31. Start setpoint is at 200 degrees F.

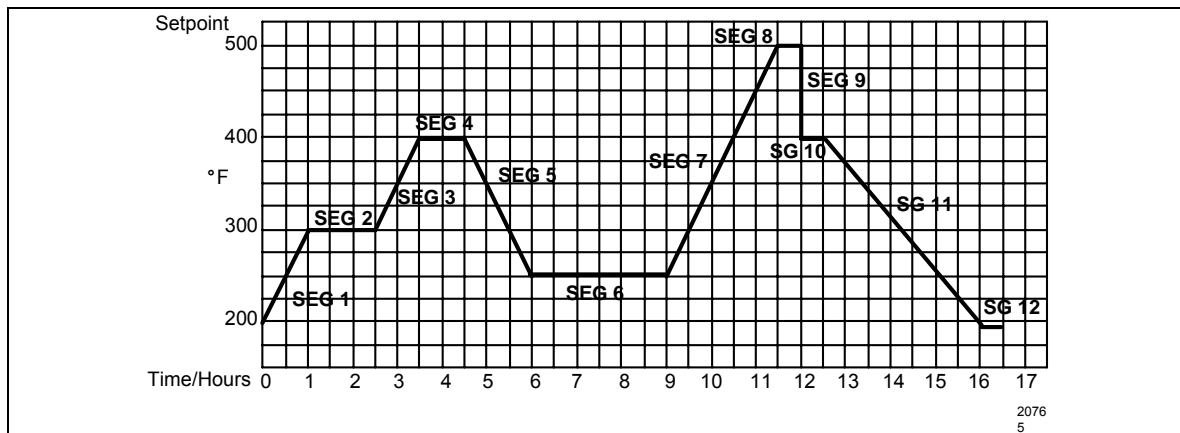

Figure 4-7 Ramp/Soak Profile Example

Table 4-31 Ramp/Soak Profile Example (Using 12 Segments)							
Prompt	Function	Segment	Value	Prompt	Function	Segment	Value
STRT SEG	Start Seg.		1	SEG4 SP	Soak SP	4	400
END SEG	End Seg.		12	SEG4TIME	Soak Time	4	1 hr.
RAMP UNIT	Engr. Unit for Ramp		TIME	SEG5RAMP	Ramp Time	5	1 hr:30 min.
RECYCLES	Number of Recycles		2	SEG6 SP	Soak SP	6	250
SOAK DEV	Deviation Value		0	SEG6TIME	Soak Time	6	3 hr:0 min.
PROG END	Controller Status		LAST SP	SEG7RAMP	Ramp Time	7	2 hr:30 min.
STATE	Controller State at end		HOLD	SEG8 SP	Soak SP	8	500
KEYRESET	Reset SP Program		DISABLE	SEG8TIME	Soak Time	8	0 hr:30 min.
POWER UP	Program Status at Power up		ABORT	SEG9RAMP	Ramp Time	9	0
HOTSTART	PV Hot Start		DISABLE	SG10 SP	Soak SP	10	400
SEG1RAMP	Ramp Time	1	1 hr.	SG10 TIME	Soak Time	10	0 hr:30 min.
SEG2 SP	Soak SP	2	300	SG11RAMP	Ramp Time	11	3 hr:30 min.
SEG2TIME	Soak Time	2	1 hr:30 min.	SG12 SP	Soak SP	12	200
SEG3RAMP	Ramp Time	3	1 hr.	SG12TIME	Soak Time	12	0 hr:30 min.

Figure 4-8 SP Program #1 Record Sheets

Draw your ramp/soak profile for SP Program 1 on the record sheet shown below and fill in the associated information in the Table provided. This will give you a permanent record of your program and will assist you when entering the Setpoint data.

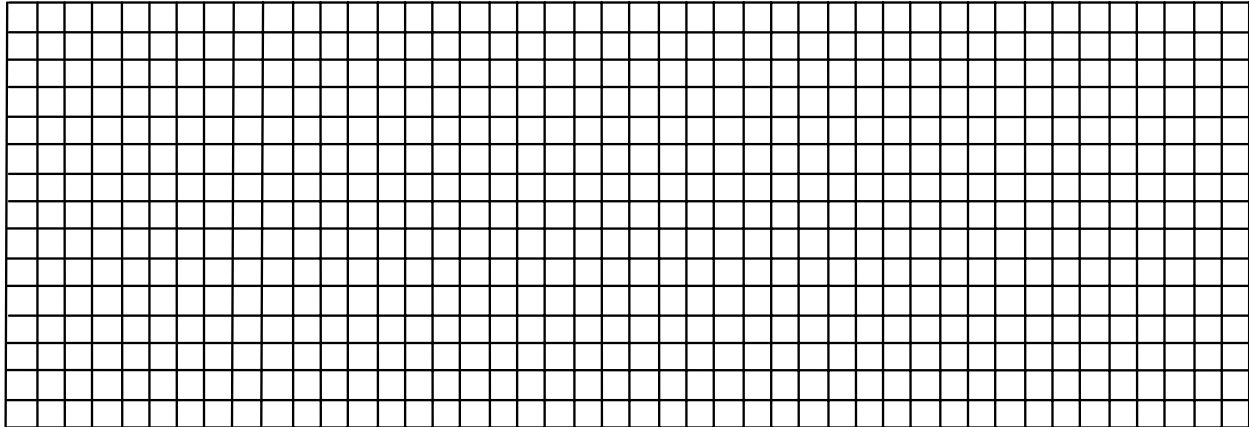

Table 4-32 Program #1 Record Sheets

Prompt	Function	Segment	Value	Prompt	Function	Segment	Value
STRT SEG	Start Seg.			SEG3RAMP	Ramp Time	3	
END SEG	End Seg.			SEG3 PID	PID Set	3	
RAMPUNIT	Engr. Unit for Ramp			SEG4 SP	Soak SP	4	
RECYCLES	Number of Recycles			SEG4TIME	Soak Time	4	
PROG END	Controller Status			SOAK4DEV	Guar. Soak	4	
STATE	Controller State at end			SEG4 PID	PID Set	4	
POWER UP	Program Status at Power up			SEG5RAMP	Ramp Time	5	
KEYRESET	Reset SP Program			SEG5 PID	PID Set	5	
HOT START	PV Hot Start Program			SEG6 SP	Soak SP	6	
SEG1RAMP	Ramp Time	1		SEG6TIME	Soak Time	6	
SEG1 PID	PID Set	1		SOAK6DEV	Guar. Soak	6	
SEG2 SP	Soak SP	2		SEG6 PID	PID Set	6	
SEG2TIME	Soak Time	2		SEG7RAMP	Ramp Time	7	
SOAK2DEV	Guar. Soak	2		SEG7 PID	PID Set	7	
SEG2 PID	PID Set	2					

Table 4-32 Program #1 Record Sheets

Prompt	Function	Segment	Value	Prompt	Function	Segment	Value
SEG8 SP	Soak SP	8		SG15RAMP	Ramp Time	15	
SEG8TIME	Soak Time	8		SG15 PID	PID Set	15	
SOAK8DEV	Guar. Soak	8		SEG16 SP	Soak SP	16	
SEG8 PID	PID Set	8		SG16TIME	Soak Time	16	
SEG9RAMP	Ramp Time	9		SOAK16DV	Guar. Soak	16	
SEG9 PID	PID Set	9		SG16 PID	PID Set	16	
SG10 SP	Soak SP	10		SG17RAMP	Ramp Time	17	
SG10 TIME	Soak Time	10		SG17 PID	PID Set	17	
SOAK10DV	Guar. Soak	10		SEG18 SP	Soak SP	18	
SG10 PID	PID Set	10		SG18TIME	Soak Time	18	
SG11RAMP	Ramp Time	11		SOAK18DV	Guar. Soak	18	
SG11 PID	PID Set	11		SG18 PID	PID Set	18	
SG12 SP	Soak SP	12		SG19RAMP	Ramp Time	19	
SG12TIME	Soak Time	12		SG19 PID	PID Set	19	
SOAK12DV	Guar. Soak	12		SEG20 SP	Soak SP	20	
SG12 PID	PID Set	12		SG20TIME	Soak Time	20	
SG13RAMP	Ramp Time	13		SOAK20DV	Guar. Soak	20	
SG13 PID	PID Set	13		SG20 PID	PID Set	20	
SEG14 SP	Soak SP	14					
SG14TIME	Soak Time	14					
SOAK14DV	Guar. Soak	14					
SG14 PID	PID Set	14					

Figure 4-9 SP Program #2 Record Sheets

Draw your ramp/soak profile for SP Program 2 on the record sheet shown below and fill in the associated information in the Table provided. This will give you a permanent record of your program and will assist you when entering the Setpoint data.

Table 4-33 Program #2 Record Sheets							
Prompt	Function	Segment	Value	Prompt	Function	Segment	Value
STRT SEG	Start Seg.			SEG5RAMP	Ramp Time	5	
END SEG	End Seg.			SEG5 PID	PID Set	5	
RAMPUNIT	Engr. Unit for Ramp			SEG6 SP	Soak SP	6	
RECYCLES	Number of Recycles			SEG6TIME	Soak Time	6	
HOT START	PV Hot Start Program			SOAK6DEV	Guar. Soak	6	
SEG1RAMP	Ramp Time	1		SEG6 PID	PID Set	6	
SEG1 PID	PID Set	1		SEG7RAMP	Ramp Time	7	
SEG2 SP	Soak SP	2		SEG7 PID	PID Set	7	
SEG2TIME	Soak Time	2		SEG8 SP	Soak SP	8	
SOAK2DEV	Guar. Soak	2		SEG8TIME	Soak Time	8	
SEG2 PID	PID Set	2		SOAK8DEV	Guar. Soak	8	
SEG3RAMP	Ramp Time	3		SEG8 PID	PID Set	8	
SEG3 PID	PID Set	3		SEG9RAMP	Ramp Time	9	
SEG4 SP	Soak SP	4		SEG9 PID	PID Set	9	
SEG4TIME	Soak Time	4		SG10 SP	Soak SP	10	
SOAK4DEV	Guar. Soak	4		SG10 TIME	Soak Time	10	
SEG4 PID	PID Set	4		SOAK10DV	Guar. Soak	10	

Table 4-33 Program #2 Record Sheets							
Prompt	Function	Segment	Value	Prompt	Function	Segment	Value
SG11RAMP	Ramp Time	11		SG17RAMP	Ramp Time	17	
SG11 PID	PID Set	11		SG17 PID	PID Set	17	
SG12 SP	Soak SP	12		SEG18 SP	Soak SP	18	
SG12TIME	Soak Time	12		SG18TIME	Soak Time	18	
SOAK12DV	Guar. Soak	12		SOAK18DV	Guar. Soak	18	
SG12 PID	PID Set	12		SG18 PID	PID Set	18	
SG13RAMP	Ramp Time	13		SG19RAMP	Ramp Time	19	
SG13 PID	PID Set	13		SG19 PID	PID Set	19	
SEG14 SP	Soak SP	14		SEG20 SP	Soak SP	20	
SG14TIME	Soak Time	14		SG20TIME	Soak Time	20	
SOAK14DV	Guar. Soak	14		SOAK20DV	Guar. Soak	20	
SG14 PID	PID Set	14		SG20 PID	PID Set	20	
SG15RAMP	Ramp Time	15					
SG15 PID	PID Set	15					
SEG16 SP	Soak SP	16					
SG16TIME	Soak Time	16					
SOAK16DV	Guar. Soak	16					
SG16 PID	PID Set	16					

Figure 4-10 SP Program #3 Record Sheets

Draw your ramp/soak profile for SP Program 3 on the record sheet shown below and fill in the associated information in the Table provided. This will give you a permanent record of your program and will assist you when entering the Setpoint data.

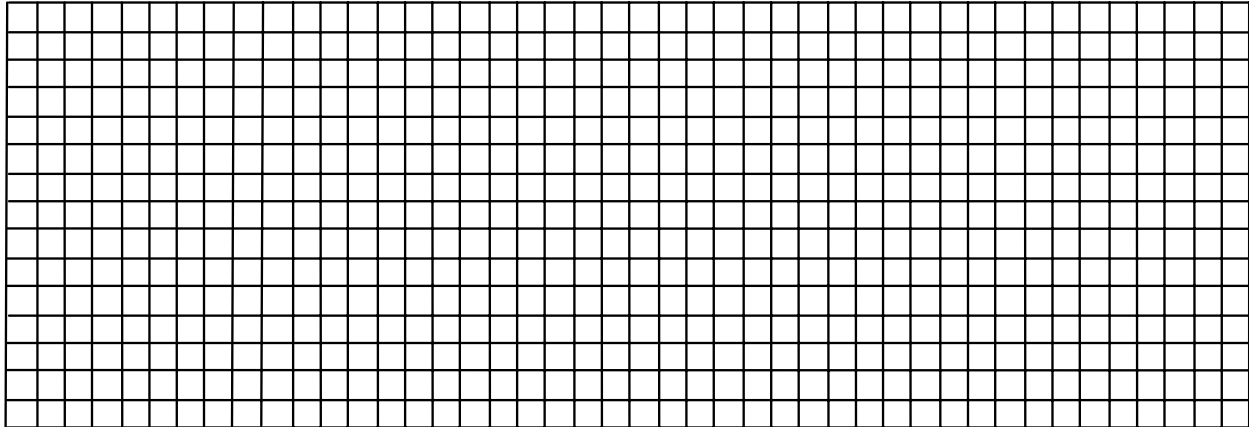

Table 4-34 Program #3 Record Sheets

Prompt	Function	Segment	Value	Prompt	Function	Segment	Value
STRT SEG	Start Seg.			SEG5RAMP	Ramp Time	5	
END SEG	End Seg.			SEG5 PID	PID Set	5	
RAMPUNIT	Engr. Unit for Ramp			SEG6 SP	Soak SP	6	
RECYCLES	Number of Recycles			SEG6TIME	Soak Time	6	
HOT START	PV Hot Start Program			SOAK6DEV	Guar. Soak	6	
SEG1RAMP	Ramp Time	1		SEG6 PID	PID Set	6	
SEG1 PID	PID Set	1		SEG7RAMP	Ramp Time	7	
SEG2 SP	Soak SP	2		SEG7 PID	PID Set	7	
SEG2TIME	Soak Time	2		SEG8 SP	Soak SP	8	
SOAK2DEV	Guar. Soak	2		SEG8TIME	Soak Time	8	
SEG2 PID	PID Set	2		SOAK8DEV	Guar. Soak	8	
SEG3RAMP	Ramp Time	3		SEG8 PID	PID Set	8	
SEG3 PID	PID Set	3		SEG9RAMP	Ramp Time	9	
SEG4 SP	Soak SP	4		SEG9 PID	PID Set	9	
SEG4TIME	Soak Time	4		SG10 SP	Soak SP	10	
SOAK4DEV	Guar. Soak	4		SG10 TIME	Soak Time	10	
SEG4 PID	PID Set	4		SOAK10DV	Guar. Soak	10	

Table 4-34 Program #3 Record Sheets							
Prompt	Function	Segment	Value	Prompt	Function	Segment	Value
SG11RAMP	Ramp Time	11		SG17RAMP	Ramp Time	17	
SG11 PID	PID Set	11		SG17 PID	PID Set	17	
SG12 SP	Soak SP	12		SEG18 SP	Soak SP	18	
SG12TIME	Soak Time	12		SG18TIME	Soak Time	18	
SOAK12DV	Guar. Soak	12		SOAK18DV	Guar. Soak	18	
SG12 PID	PID Set	12		SG18 PID	PID Set	18	
SG13RAMP	Ramp Time	13		SG19RAMP	Ramp Time	19	
SG13 PID	PID Set	13		SG19 PID	PID Set	19	
SEG14 SP	Soak SP	14		SEG20 SP	Soak SP	20	
SG14TIME	Soak Time	14		SG20TIME	Soak Time	20	
SOAK14DV	Guar. Soak	14		SOAK20DV	Guar. Soak	20	
SG14 PID	PID Set	14		SG20 PID	PID Set	20	
SG15RAMP	Ramp Time	15					
SG15 PID	PID Set	15					
SEG16 SP	Soak SP	16					
SG16TIME	Soak Time	16					
SOAK16DV	Guar. Soak	16					
SG16 PID	PID Set	16					

Figure 4-11 SP Program #4 Record Sheets

Draw your ramp/soak profile for SP Program 4 on the record sheet shown below and fill in the associated information in the Table provided. This will give you a permanent record of your program and will assist you when entering the Setpoint data.

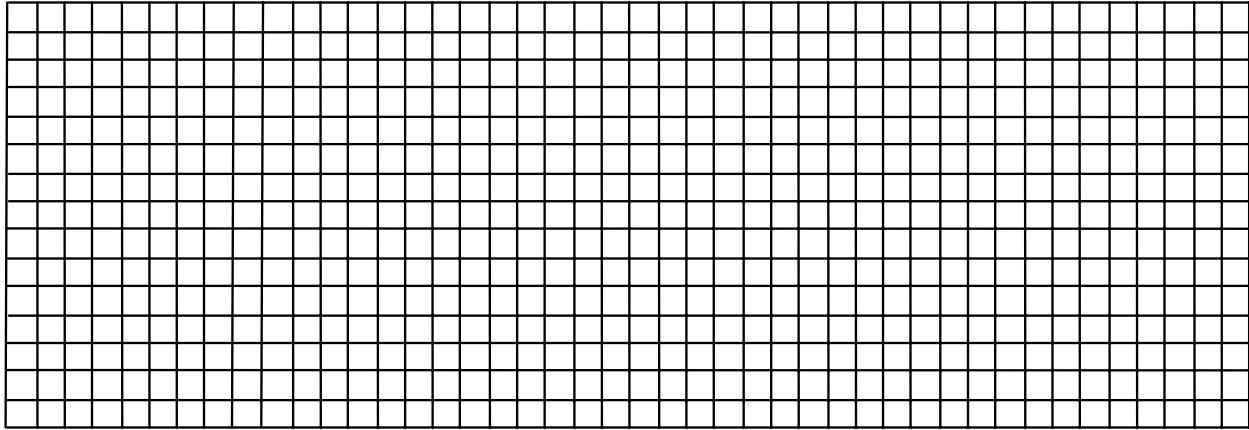

Table 4-35 Program #4 Record Sheets

Prompt	Function	Segment	Value	Prompt	Function	Segment	Value
STRT SEG	Start Seg.			SEG5RAMP	Ramp Time	5	
END SEG	End Seg.			SEG5 PID	PID Set	5	
RAMPUNIT	Engr. Unit for Ramp			SEG6 SP	Soak SP	6	
RECYCLES	Number of Recycles			SEG6TIME	Soak Time	6	
HOT START	PV Hot Start Program			SOAK6DEV	Guar. Soak	6	
SEG1RAMP	Ramp Time	1		SEG6 PID	PID Set	6	
SEG1 PID	PID Set	1		SEG7RAMP	Ramp Time	7	
SEG2 SP	Soak SP	2		SEG7 PID	PID Set	7	
SEG2TIME	Soak Time	2		SEG8 SP	Soak SP	8	
SOAK2DEV	Guar. Soak	2		SEG8TIME	Soak Time	8	
SEG2 PID	PID Set	2		SOAK8DEV	Guar. Soak	8	
SEG3RAMP	Ramp Time	3		SEG8 PID	PID Set	8	
SEG3 PID	PID Set	3		SEG9RAMP	Ramp Time	9	
SEG4 SP	Soak SP	4		SEG9 PID	PID Set	9	
SEG4TIME	Soak Time	4		SG10 SP	Soak SP	10	
SOAK4DEV	Guar. Soak	4		SG10 TIME	Soak Time	10	
SEG4 PID	PID Set	4		SOAK10DV	Guar. Soak	10	

Table 4-35 Program #4 Record Sheets							
Prompt	Function	Segment	Value	Prompt	Function	Segment	Value
				SG10 PID	PID Set	10	
SG11RAMP	Ramp Time	11		SG17RAMP	Ramp Time	17	
SG11 PID	PID Set	11		SG17 PID	PID Set	17	
SG12 SP	Soak SP	12		SEG18 SP	Soak SP	18	
SG12TIME	Soak Time	12		SG18TIME	Soak Time	18	
SOAK12DV	Guar. Soak	12		SOAK18DV	Guar. Soak	18	
SG12 PID	PID Set	12		SG18 PID	PID Set	18	
SG13RAMP	Ramp Time	13		SG19RAMP	Ramp Time	19	
SG13 PID	PID Set	13		SG19 PID	PID Set	19	
SEG14 SP	Soak SP	14		SEG20 SP	Soak SP	20	
SG14TIME	Soak Time	14		SG20TIME	Soak Time	20	
SOAK14DV	Guar. Soak	14		SOAK20DV	Guar. Soak	20	
SG14 PID	PID Set	14		SG20 PID	PID Set	20	
SG15RAMP	Ramp Time	15					
SG15 PID	PID Set	15					
SEG16 SP	Soak SP	16					
SG16TIME	Soak Time	16					
SOAK16DV	Guar. Soak	16					
SG16 PID	PID Set	16					

Run/Monitor the program

Prior to running the program, make sure all the “SP PROG” function prompts under the Set Up group “SP RAMP” have been configured with the required data.



“H” appears in the upper display indicating that the program is in the HOLD state.

ATTENTION SP Program parameter *cannot* be changed during RUN state; the unit must be in the HOLD state in order to change parameters.

Run/Monitor functions

Table 4-36 lists all the functions required to run and monitor the program.

Table 4-36 Run/Monitor Functions

Function	Press	Result
Set the Local Setpoint	Lower Display	<i>Upper Display</i> = PV value <i>Lower Display</i> = SP
	 or 	To set the Local Setpoint value to where you want the program to start out.
Run State	Run/Hold	Initiates the setpoint program. “R” appears in the upper display indicating that the program is running.
Hold State	Run/Hold	Holds the setpoint program. “H” appears in the upper display indicating that the program is in the HOLD state. The setpoint holds at the current setpoint.
External Hold		If one of the Digital Inputs is programmed for the HOLD function, then contact closure places the controller in the HOLD state, if the setpoint program is running. The upper display will periodically show “H” while the switch is closed. ATTENTION The keyboard takes priority over the external switch for the RUN/HOLD function. Reopening the HOLD switch runs the program.
Viewing the present ramp or soak segment number and time	Lower Display until you see	<i>Upper Display</i> = PV value <i>Lower Display</i> = XXRAHH.MM for Ramps or = XXSKHH.MM for Soaks Time remaining in the SEGMENT in hours and minutes. XX = The segment number, 1 to 12.

Continued

Function	Press	Result
Viewing the number of cycles left in the program	Lower Display until you see	<i>Upper Display</i> = PV value <i>Lower Display</i> = RECYC XX Number of cycles remaining in the setpoint program. X = 0 to 99
End Program		When the final segment is completed, the “R” in the upper display either changes to “H” (if configured for HOLD state), or disappears (if configured for disable of setpoint programming). <ul style="list-style-type: none"> The controller then either operates at the last setpoint in the program or goes into manual mode/failsafe output, depending upon the “LAST” configuration.
Disable Program		See Section 3 – Configuration Group “SP PROG” for details.

Power outage

ATTENTION If power is lost during a program, upon power-up the controller will be in hold and the setpoint value will be the setpoint value prior to the beginning of the setpoint program. The program is placed in hold at the beginning. The mode will be as configured under “PWR UP” in the “CONTROL” group.

Digital Input (remote switch) operation

Program can be placed in RUN, HOLD, RERUN, or BEGIN state through a remote dry contact connected to optional digital input terminals, as follows:

RUN—contact closure places Program in RUN state, OR

HOLD—contact closure places Program in HOLD state

RERUN—contact closure allows the Setpoint Programmer to be reset to the initial segment of its current cycle, unit stays in previous mode.

Opening the contact will cause the Controller to revert to its original state.

BEGIN— Contact closure resets the SP Program back to the beginning of the first segment in the program and puts the program in the HOLD mode. Program cycle number is not affected. Reopening the switch has no effect.

Opening the contact will cause the Controller to revert to its original state.

Setpoint Program Event Alarms

See the example in Section 0 for help in configuring Alarm Events based upon segments in the Setpoint Program.

4.31 P.I.E. Tool Maintenance Screens

Introduction

This controller uses special P.I.E. Tool[®] Maintenance Screens which allow remote access and access to functions not accessible via the controller's display and keyboard. The figures in this section show screen-shots of the Maintenance Screens from the PC version of the P.I.E. Tool[®]. Pocket PC Maintenance Screens are generally similar in format but smaller.

Loop Data

Select "Loop Data" from the "Maintenance Data" menu.

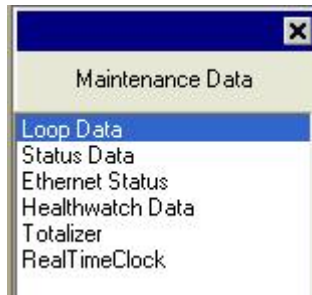

The Loop Data screen allows you to see the current status of each process loop. "OP1, 2 and 3" windows indicate the status of the current outputs. If a current output is not installed, the OP status for that output is always "OK."

The "Alarms" and "Digital Inputs" buttons allow you to see the current status of each alarm setpoint and digital input.

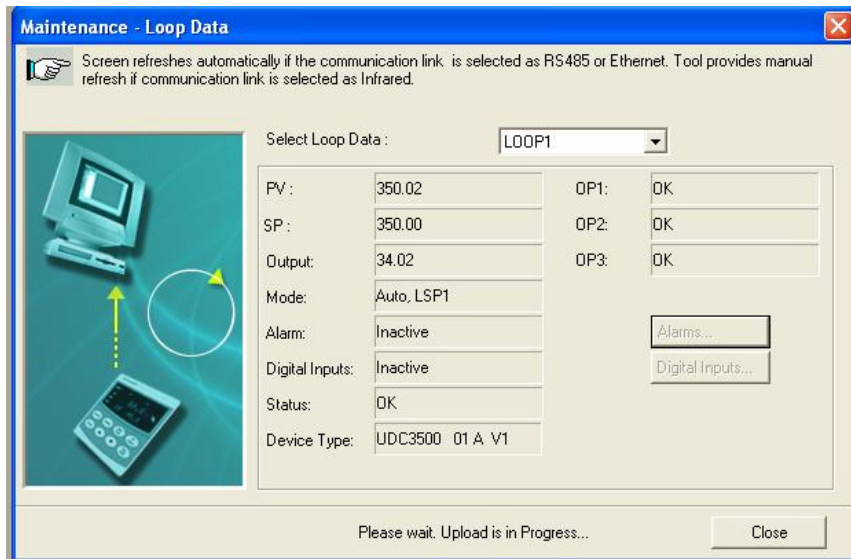

Figure 4-12 Loop Data Maintenance Screen

Loop Data – Alarm Details

This screen appears when you click on the “Alarm” button on the Loop Data Maintenance Screen and shows the status of each alarm setpoint. “NONE” in the Type column indicates that the alarm is disabled. Highlighted alarms are currently active. An asterisk (*) indicates that the alarm has changed state since the last communications transaction.

If the controller does not have the Real Time Clock option, then the “Alarm On” and “Alarm Off” columns are always blank. If the controller does have the Real Time Clock option, then these columns will show the date and time that each alarm setpoint turned on and turned off. A blank in the “Alarm On” column indicates that the alarm has never been activated and a blank in the “Alarm Off” column indicates that the alarm has never been inactive.

See Section 3.24 for other information about configuring Alarms.

The screenshot shows a window titled "Maintenance Data - Alarm Details". It contains a table with the following data:

Alarm	Type	Event	Value	Actual	Alarm On	Alarm Off
Alarm1-SP1	INPUT 1	HIGH/END	500.00	349.98	28 September 2005 10:25:56:000	28 September 2005 11:10:52:000
Alarm1-SP2	NONE	HIGH/END	0.00	0.00		
Alarm2-SP1*	DIG IN1	HIGH/END	0.00	0.00	29 September 2005 09:31:28:833	
Alarm2-SP2	NONE	HIGH/END	0.00	0.00		
Alarm3-SP1	NONE	HIGH/END	0.00	0.00		
Alarm3-SP2	NONE	HIGH/END	0.00	0.00		
Alarm4-SP1	NONE	HIGH/END	0.00	0.00		
Alarm4-SP2	NONE	HIGH/END	0.00	0.00		

Figure 4-13 Alarm Details Maintenance Screen

Loop Data – Digital Input Details

This screen appears when you click on the “Digital Inputs” button on the Loop Data Maintenance Screen and shows the status of each Digital Input. “NONE” in the Type column indicates that the Digital Input is disabled. Highlighted Digital Inputs are currently active. An asterisk (*) indicates that the alarm has changed state since the last communications transaction.

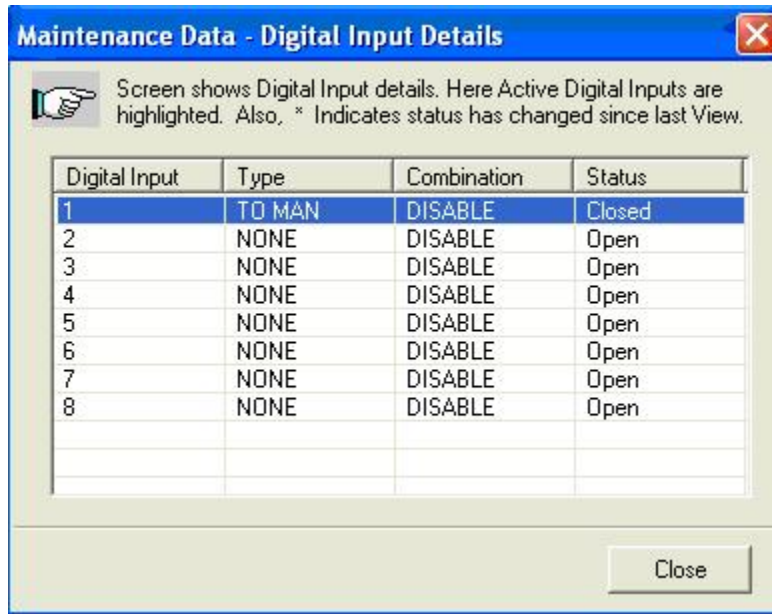
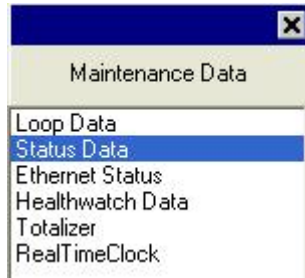

Figure 4-14 Digital Inputs Details Maintenance Screen

Status Data

Select “Status Data” from the “Maintenance Data” menu.



The Status Data screen lets you see the current status of the controller’s diagnostics. If the controller has detected a problem, this screen will show the detected problem. If the controller is equipped with the Real Time Clock Option, then pressing the “Diagnostics” button will show the time and dates that the problem occurred and when it was cleared.

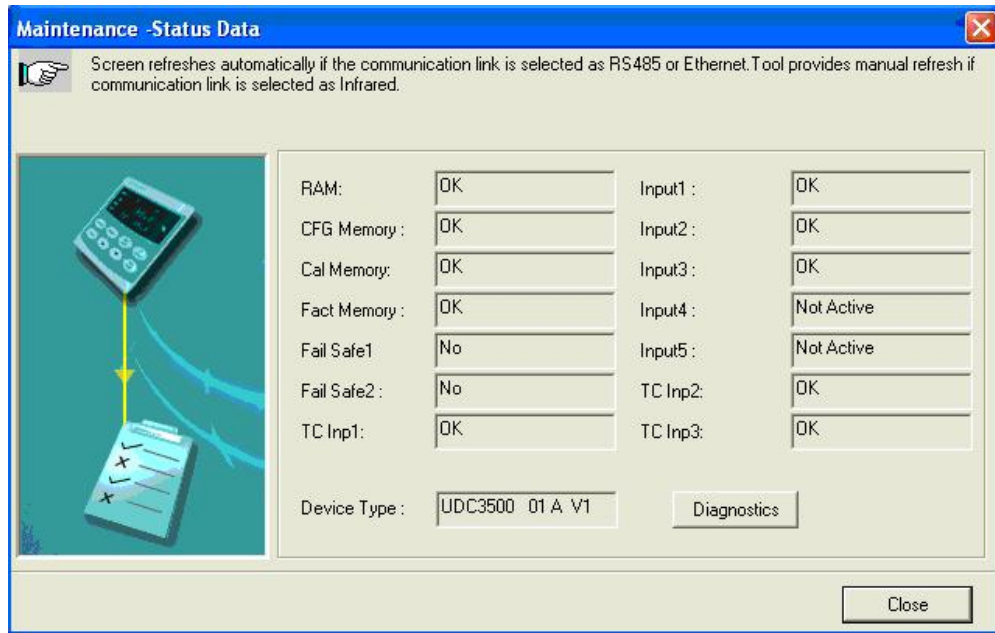
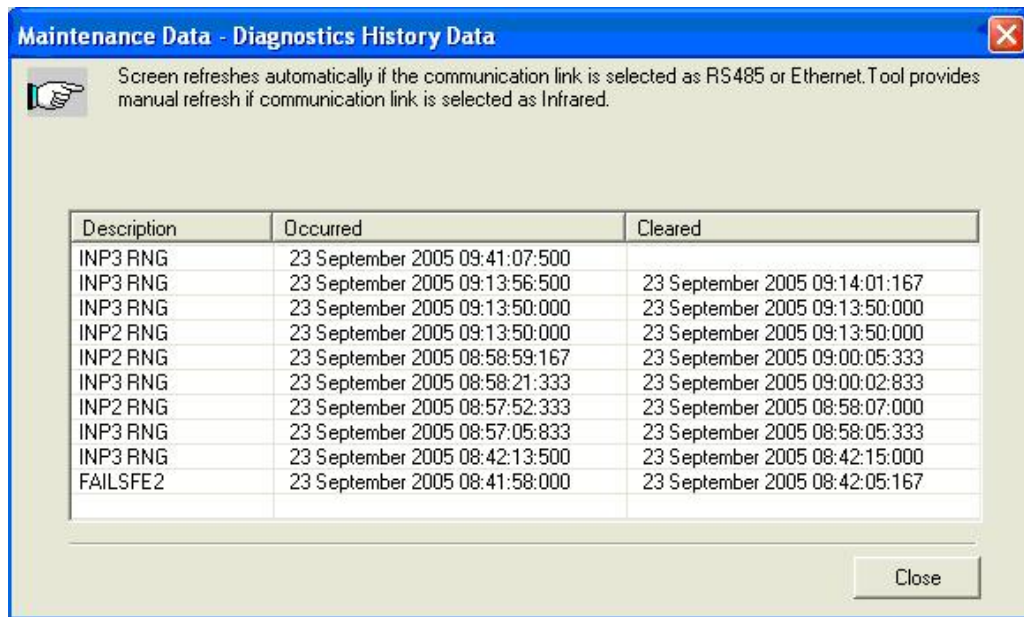

Figure 4-15 Status Data Maintenance Screen

Status Data – Diagnostics History

This screen is only in instruments that have the Real Time Clock option and appears when you click on the “Diagnostics” button on the Status Data Maintenance Screen. The Diagnostic screen shows the last ten diagnostic conditions that have occurred. A blank in the “Cleared” column indicates that the problem still exists. Essentially, this screen shows the same diagnostic messages as available on the controller via the lower display window.

See Section 7 for other information about Troubleshooting and Diagnostics.



Description	Occurred	Cleared
INP3 RNG	23 September 2005 09:41:07:500	
INP3 RNG	23 September 2005 09:13:56:500	23 September 2005 09:14:01:167
INP3 RNG	23 September 2005 09:13:50:000	23 September 2005 09:13:50:000
INP2 RNG	23 September 2005 09:13:50:000	23 September 2005 09:13:50:000
INP2 RNG	23 September 2005 08:58:59:167	23 September 2005 09:00:05:333
INP3 RNG	23 September 2005 08:58:21:333	23 September 2005 09:00:02:833
INP2 RNG	23 September 2005 08:57:52:333	23 September 2005 08:58:07:000
INP3 RNG	23 September 2005 08:57:05:833	23 September 2005 08:58:05:333
INP3 RNG	23 September 2005 08:42:13:500	23 September 2005 08:42:15:000
FAILSFE2	23 September 2005 08:41:58:000	23 September 2005 08:42:05:167

Figure 4-16 Diagnostic History Maintenance Screen

Ethernet Status

Select “Ethernet Status” from the “Maintenance Data” menu.

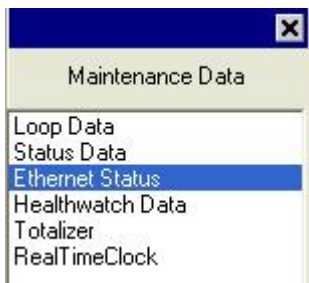

This screen only appears in instruments that have the Ethernet Communications option. Essentially, this screen shows the same Ethernet diagnostic messages as available on the controller via the lower display window. See Section 7.5 for details.

The Ethernet Status screen shows the network status of the Ethernet Link. This may be accessed either via Ethernet or via Infrared communications. Not all diagnostic messages are available via Ethernet Communications. For example, if the Ethernet cable is unplugged, then the instrument cannot send up the “EUNPLGED” diagnostic message via Ethernet.

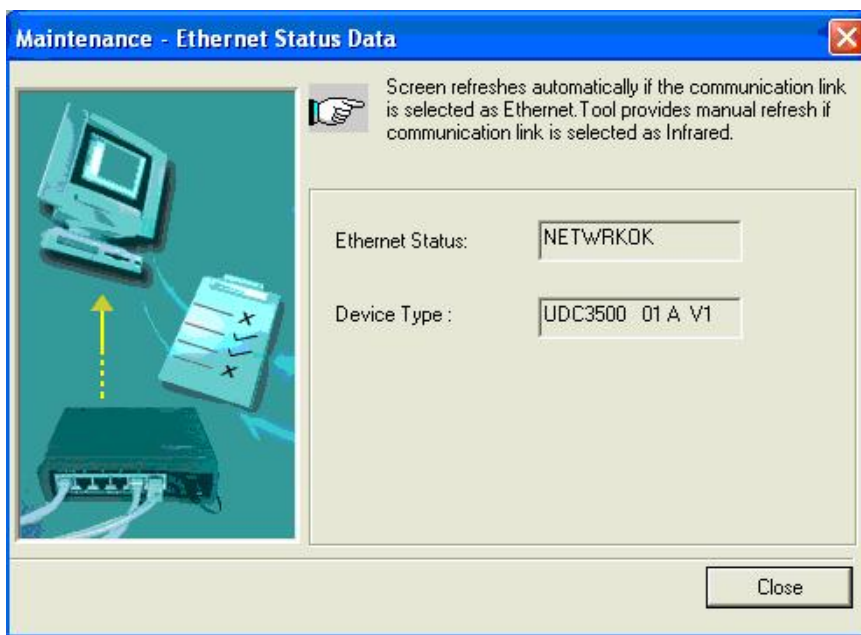
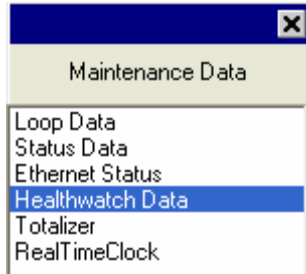

Figure 4-17 Ethernet Status Maintenance Screen

Healthwatch Data

Select “Healthwatch Data” from the “Maintenance Data” menu.



This screen only appears in instruments that have the Healthwatch option. The Healthwatch screen shows the current values of the various counters and timers used by Healthwatch. This data may be saved to your PC as a Comma Separated Variable (CSV) file by pressing the “Save” button. See Section 3.26 for other information about Healthwatch. The Reset button calls up a menu allowing individual timers and counters to be reset back to zero. See next page.

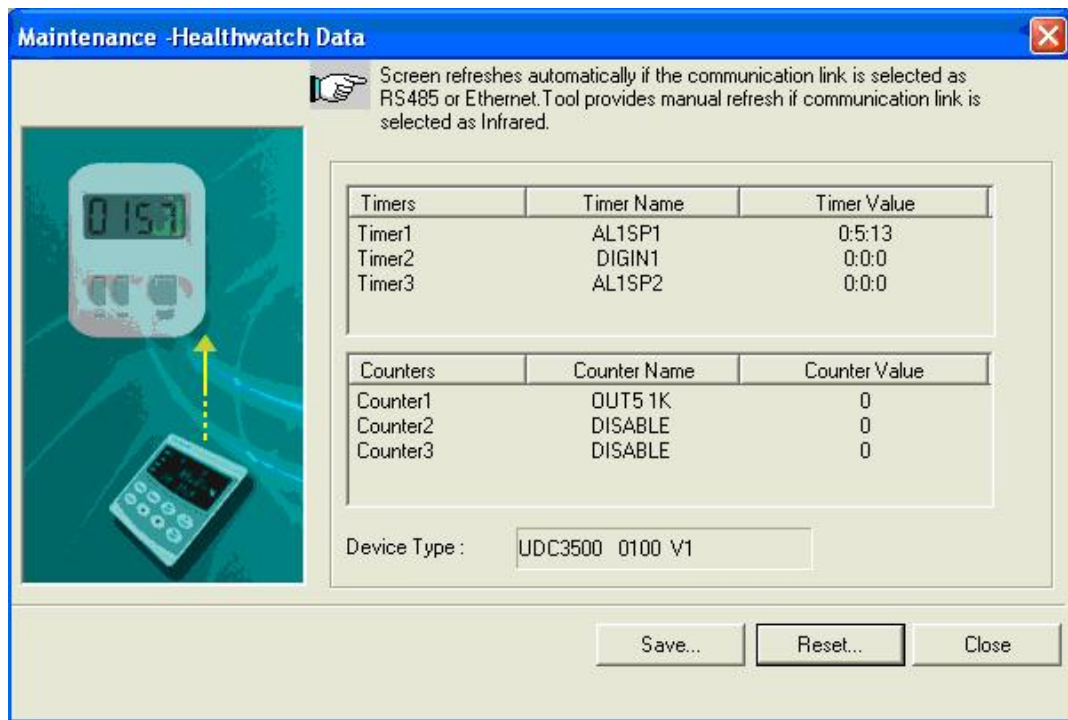

Figure 4-18 Healthwatch Data Maintenance Screen

Healthwatch Data - Reset

This screen only appears in instruments that have the Healthwatch option and appears when you click on the “Reset” button on the Healthwatch Data Maintenance Screen. The Healthwatch Reset screen allows you to reset the various Timers and Counters back to zero. The Password is configured as part of the Maintenance Set Up Group. See Section 3.26.

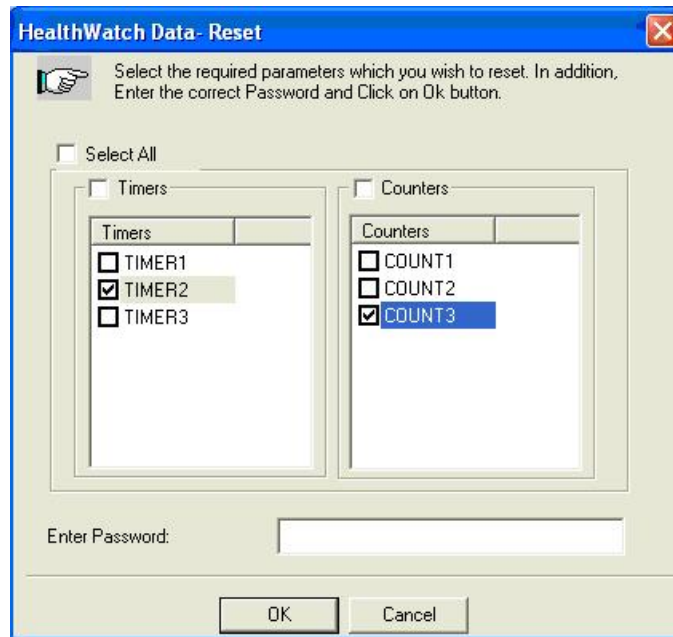
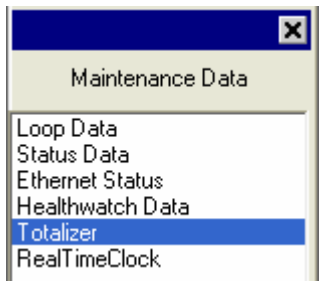

Figure 4-19 Healthwatch Data Reset Screen

Totalizer Data

Select “Totalizer” from the “Maintenance Data” menu.



This screen only appears in instruments that have the Totalizer option. The Totalizer screen shows the current values of the Totalizer. The **Reset button** sets the Totalizer Value back to zero.

See Section 3.12 for other information about the Totalizer option.

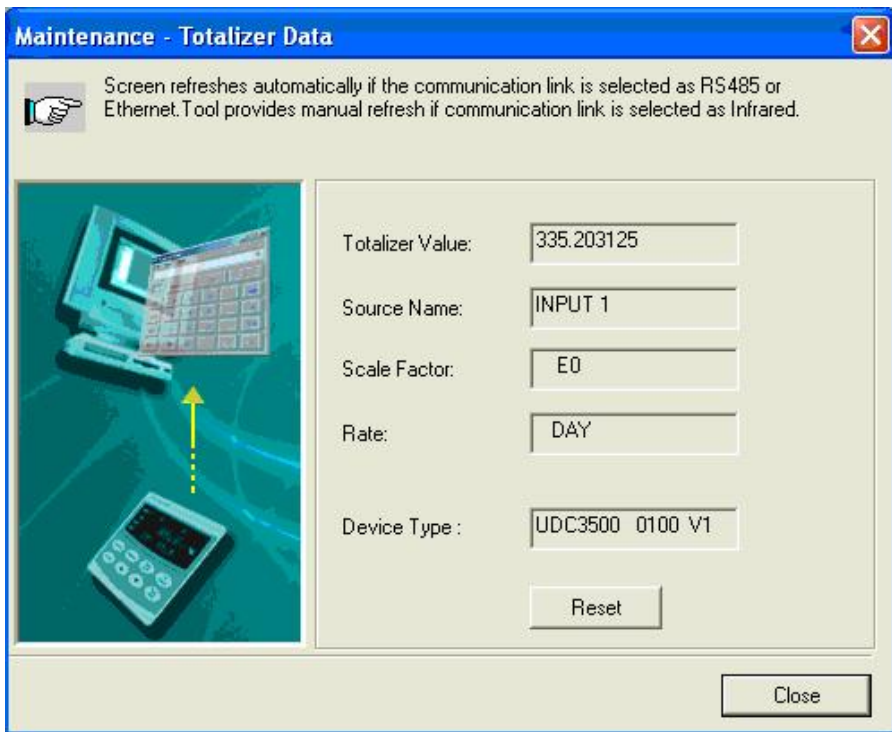
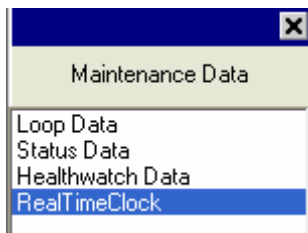

Figure 4-20 Totalizer Maintenance Screen

Real Time Clock

Select “Real Time Clock” from the “Maintenance Data” menu.



This screen only appears in instruments that have the Real Time Clock option. The Real Time Clock Screen shows both the clock time in the controller and the clock time in your PC. Pressing the “Set Clock” button will set the controller to the same settings as in your PC. It is recommended that units using Email use only this screen to set the Real Time Clock, as that will ensure that the clock and time zone settings used to time-stamp Emails are correct.

See Section 3.25 for other information about the Real Time Clock option.

ATTENTION

The Real Time Clock will not automatically adjust for Daylight Savings Time; it must be done manually.

The Real Time Clock will automatically adjust for Leap Years to make February 29 days long.

Instruments that do not have the Real Time Clock option will always send Email time-stamped with the date that the Ethernet Software in the instrument was last modified. Instruments with the Real Time Clock option will send Email time-stamped with the current time in the controller.

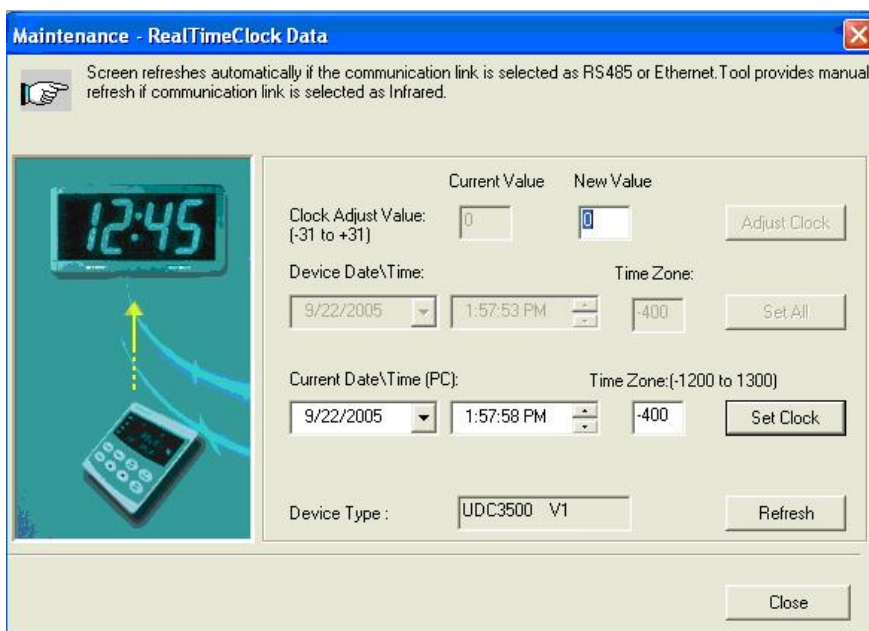

Figure 4-21 Real Time Clock Maintenance Screen

4.32 Configuring your Ethernet Connection

Introduction

This controller is shipped from the factory with the address for Infrared (IR) communications set to 3, the Ethernet IP Address set to 10.0.0.2, the Ethernet Subnet Mask set to 255.255.255.0 and the Ethernet Default Gateway set to 0.0.0.0. Consult your Information Technologies (IT) representative as to how these should be configured for your installation. The MAC address is printed on the product label located on the instrument's case.

Only the P.I.E. Tool can be used to configure Ethernet parameters. The figures in this section show screen-shots from the PC version of the P.I.E. Tool® Screens. Pocket PC Screens are generally similar in format but smaller. The P.I.E. Tool can connect to your controller via either Ethernet communications port or the Infrared (IR) communications port.

Connecting to the Controller via Infrared Communications

If connecting via IR and assuming that the instrument's IR address has not been changed from its factory setting of 3, then configure your Communications Type as "Infrared" and your IR address to 3 as shown below.

Select "PC COMM Setup", then select "Infrared".

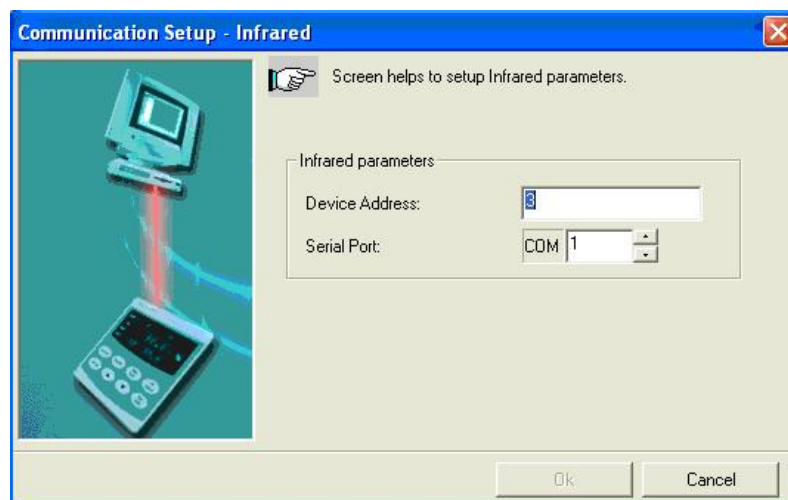
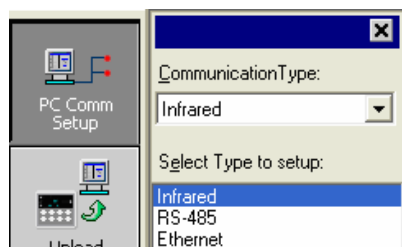
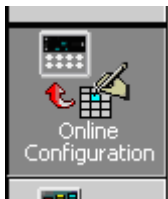

Figure 4-22 IR Communications Address

Close the IR configuration window and then single click on the “Online Configuration” button.



Press any button on the controller’s keyboard to activate the controller’s IR port. Point your IR dongle (if using PC) or your Pocket PC’s IR port (if using Pocket PC) at the IR window on the front of the controller and then click on the “Start” button. The P.I.E. Tool[®] should start uploading the configuration information from the controller as shown below:

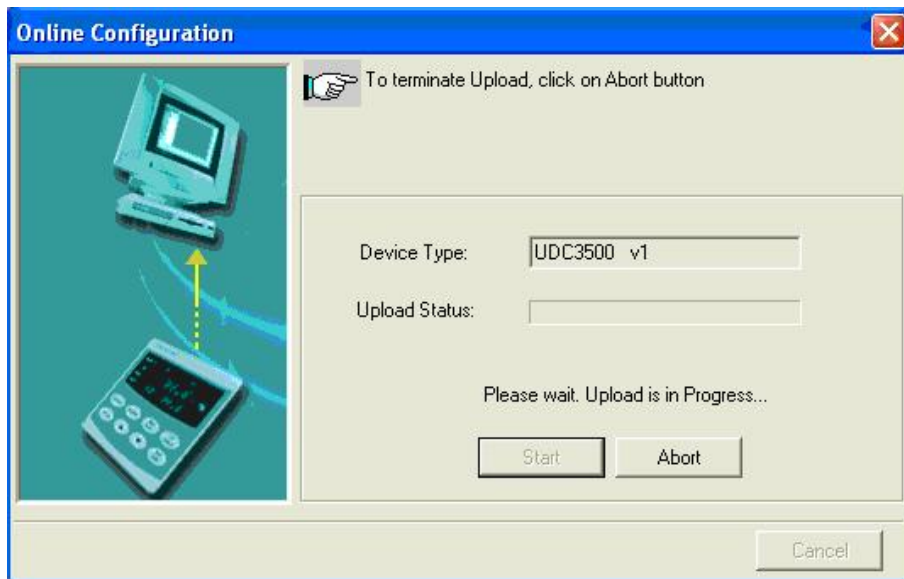

Figure 4-23 Configuration Upload in Progress

Once the upload is complete, click on the “Ethernet & Email” Group. Configure your Ethernet and Email parameters per Section 3.30.

Once you have changed the Ethernet settings and downloaded them to your controller, you will now be able to communicate with it via Ethernet.

Connecting to the Controller via Ethernet Communications

WARNING

Connecting to the Controller via Ethernet Communications requires that you change your PC's IP settings. If you have never done this before, then it is **strongly** recommended that you consult with your Information Technologies (IT) representative before proceeding.

First, write down the current IP Address, Subnet Mask and Default Gateway settings for your PC. Put these someplace that you can find them later.

Connecting to the Ethernet Port in the Controller requires that you have either an Ethernet crossover cable or a MDI-compliant Switch or Hub available with a straight-through cable. The crossover cable can be used to directly connect your PC to the Controller while the Switch or Hub can be used to connect your PC and Controller to the Hub or Switch via straight-through cables.

Once you have made an Ethernet connection between your PC and the controller, then change the Local Area Network (LAN) settings on your PC to be as follows:

IP Address: 10.0.0.3
Subnet Mask: 255.255.255.0
Default Gateway: 10.0.0.1

Open your P.I.E. Tool[®] program and select “PC Comm Setup”.

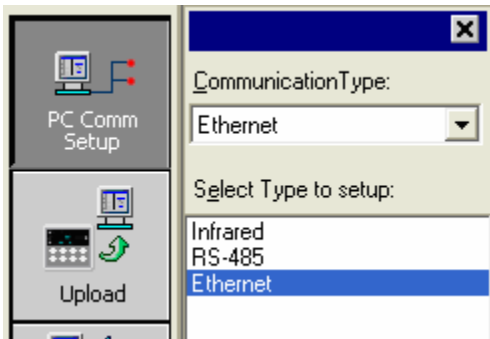

. Now configure your “Communication Type” to Ethernet and your Ethernet address to 10.0.0.2 as shown in Figure 4-24.

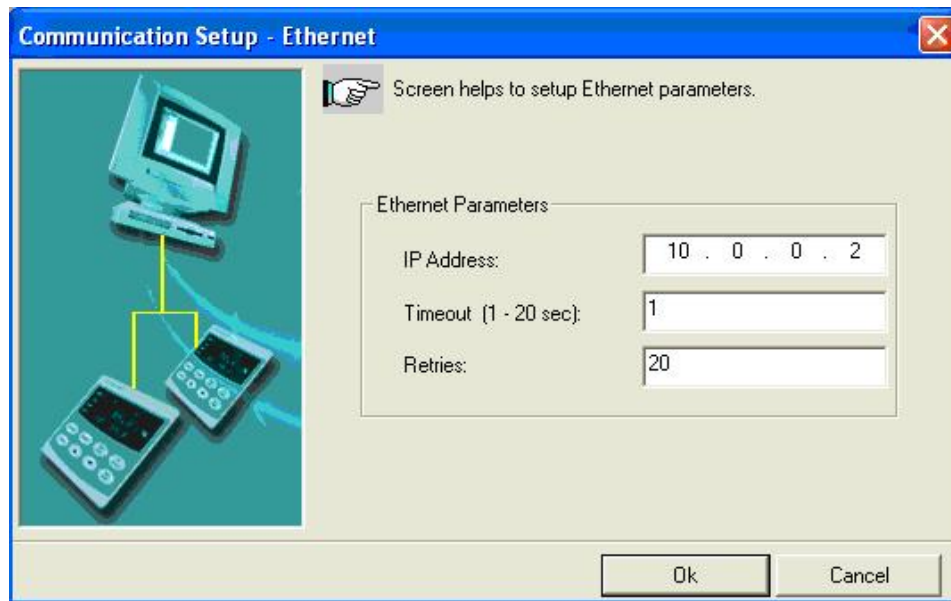
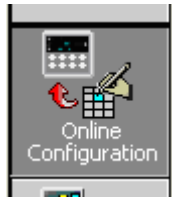

Figure 4-24 Ethernet Communications Address

Close the Ethernet configuration window and then single click on the “Online Configuration” button.



Then, click on the “Start” button. The P.I.E. Tool[®] should start uploading the configuration information from the controller as shown below:

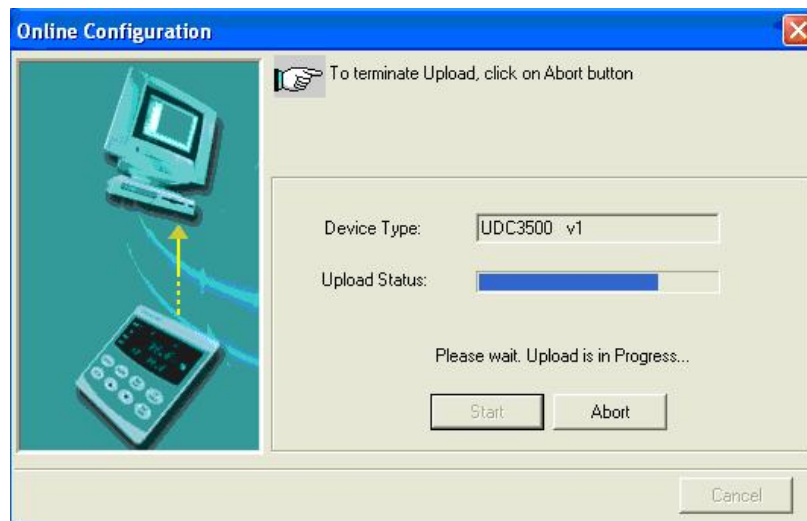

Figure 4-25 Configuration Upload in Progress

Once the upload is complete, click on the “Ethernet & Email” Group. Configure your Ethernet and Email parameters per Section 3.30.

Once you have changed the Ethernet settings and downloaded them to your controller, you will no longer be able to communicate with it until you change the IP address in the P.I.E. Tool[®] to the controller’s new IP Address.

You will also need to re-configure the Local Area Network (LAN) settings on your PC back to their original settings. On some PCs and LANs, it is possible to simply allow the PC to get these settings automatically via the DHCP server. Contact your Information Technologies (IT) representative to see if this is available on your PC.

5 Input Calibration



WARNING—SHOCK HAZARD

INPUT CALIBRATION MAY REQUIRE ACCESS TO HAZARDOUS LIVE CIRCUITS, AND SHOULD ONLY BE PERFORMED BY QUALIFIED SERVICE PERSONNEL. MORE THAN ONE SWITCH MAY BE REQUIRED TO DE-ENERGIZE UNIT BEFORE CALIBRATION.

5.1 Overview

Introduction

This section describes the field calibration procedures for Analog Inputs 1 through 5.

- All input actuations in every controller are fully factory-calibrated and are ready for configuration by the user.
- Field Calibration can improve the accuracy of the Controller if necessary for a particular application.

CAUTION

The field calibration will be lost if a change in input type configuration is implemented at a later time. The original factory calibration data remains available for later use after a field calibration is done. See Section 5.6 if you want to restore factory calibration values.

What's in this section?

The following topics are covered in this section.

TOPIC	See Page
5.1 Overview	277
5.2 Minimum and Maximum Range Values	278
5.3 Preliminary Information	280
5.4 Input Set Up Wiring	282
5.5 Input Calibration Procedure	291
5.6 Restore Input Factory Calibration	293

Calibration Steps

Use the following steps when calibrating an input.

Step	Action
1	Find the minimum and maximum range values for your PV input range from Table 5-1.
2	Disconnect the field wiring and find out what equipment you will need to calibrate.
3	Wire the calibrating device to your controller according to the set up wiring instructions for your particular input (Subsection 5.4)
4	Follow the calibration procedure given for Input #1 or Input #2 (Subsection 5.5).

5.2 Minimum and Maximum Range Values

Select the Range Values

Calibrate the controller for the minimum (0 %) and maximum (100 %) range values of your particular input type. Instruments with two or more analog inputs will need to have each input calibrated separately.

Select the Voltage, Current or Resistance equivalents for 0 % and 100 % range values from Table 5-1. Use these values when calibrating your controller.

Table 5-1 Voltage, Milliamp and Resistance Equivalents for Input Range Values

Sensor Type	PV Input Range		Range Values	
	°F	°C	0 %	100 %
Thermocouples (per ITS-90)				
B TC	0 to 3300	-18 to 1816	-0.100 mV	13.769 mV
E TC H	-454 to 1832	-270 to 1000	-9.835 mV	76.373 mV
E TC L	-200 to 1100	-129 to 593	-6.472 mV	44.455 mV
J TC H	0 to 1600	-18 to 871	-0.886 mV	50.060 mV
J TC M	20 to 900	-7 to 482	-0.334 mV	26.400 mV
J TC L	20 to 550	-7 to 288	-0.334 mV	15.650 mV
K TC H	0 to 2400	-18 to 1316	-0.692 mV	52.952 mV
K TC M	-20 to 1200	-29 to 649	-1.114 mV	26.978 mV
K TC L	-20 to 750	-29 to 399	-1.114 mV	16.350 mV
NNM H	32 to 2500	0 to 1371	0.000 mV	71.773 mV
NNM L	32 to 1260	0 to 682	0.000 mV	31.825 mV
NIC H	0 to 2372	-18 to 1300	-0.461 mV	47.513 mV
NIC L	0 to 1472	-18 to 800	-0.461 mV	28.455 mV
PLAT H	32 to 2516	0 to 1380	0.000 mV	54.798 mV

Sensor Type	PV Input Range		Range Values	
	°F	°C	0 %	100 %
PLAT L	32 to 1382	0 to 750	0.000 mV	31.272 mV
R TC	0 to 3100	-18 to 1704	-0.090 mV	20.281 mV
S TC	0 to 3100	-18 to 1704	-0.092 mV	17.998 mV
T TC H	-300 to 700	-184 to 371	-5.341 mV	19.097 mV
T TC L	-200 to 500	-129 to 260	-4.149 mV	12.574 mV
W TC H	0 to 4200	-18 to 2315	-0.234 mV	37.075 mV
W TC L	0 to 2240	-18 to 1227	-0.234 mV	22.283 mV
RP20-RP40	32 to 3216	0 to 1880	0.000 mV	4.933 mV
Thermocouple Differential *	-50 to 150	-46 to 66	-1.54 mV	4.62 mV
Honeywell Radiamatic				
Type RH	0 to 3400	-18 to 1871	0.00 mV	57.12 mV
Type RI **	0 to 3400	-18 to 1871	0.00 mV	60.08 mV
RTD Alpha = 0.00385 per IEC-60751 (1995)				
100 ohms	-300 to 1200	-184 to 649	25.202 ohms	329.289 ohms
100 ohms (low)	-300 to 300	-184 to 149	25.202 ohms	156.910 ohms
200 ohms	-300 to 1200	-184 to 649	50.404 ohms	658.578 ohms
500 ohms	-300 to 1200	-184 to 649	126.012 ohms	1646.445 ohms
1000 ohms	-300 to 1200	-184 to 649	252.020 ohms	3292.890 ohms
Linear				
Milliamps	4 to 20 mA 0 to 20 mA		4.00 mA 0.00 mA	20.00 mA 20.00 mA
Millivolts	0 to 10 mV 0 to 50 mV 0 to 100 mV 0 to 500 mV -10 to 10 mV		0.00 mV 0.00 mV 0.00 mV 0.00 mV -10.0 mV	10.00 mV 50.00 mV 100.00 mV 500.00 mV 10.00 mV
Volts	0 to 1 Volts 1 to 5 Volts 0 to 5 Volts 0 to 10 Volts -1 to 1 Volts		0.00 Volts 1.00 Volts 0.00 Volts 0.00 Volts -1.00 Volts	1.00 Volts 5.00 Volts 5.00 Volts 10.00 Volts 1.00 Volts
Carbon Oxygen	0 to 1250 mV -30 to 510 mV		0.00 mV -30.00 mV	1250.00 mV 510.00 mV

* The Thermocouple Differential Input calibration voltages are for a pair of J thermocouples at an ambient temperature mean of 450°F / 232°C. Other thermocouple types and ambient temperature means may be accomplished via Field Calibration of the input, with the range value limits being -4 mV to +16 mV for the zero and span values. See Table 5-7.

** The range values for Radiamatic Type RI are customer configurable within the limits shown.

5.3 Preliminary Information

Disconnect the Field Wiring

Tag and disconnect any field wiring connected to the input terminals on the rear of the controller.

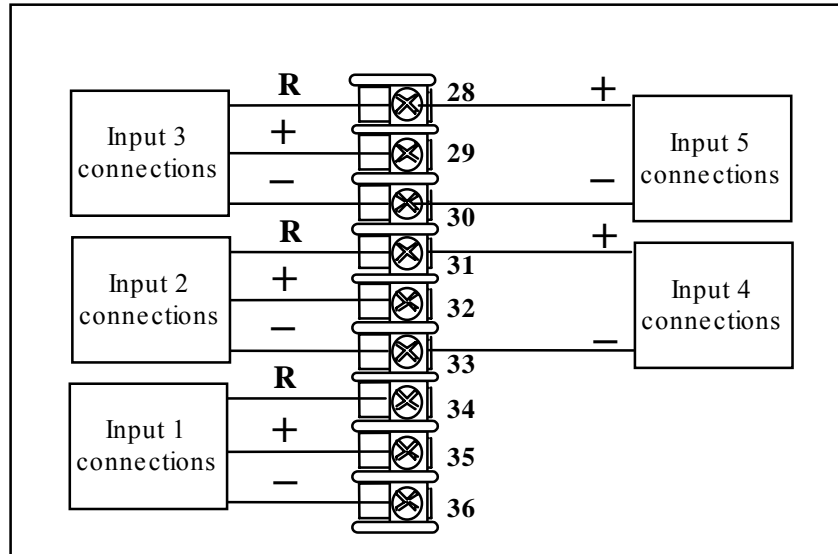

Figure 5-1 Input Wiring Terminals

Equipment Needed

Table 5-2 lists the equipment you will need to calibrate the specific types of inputs that are listed in the table. You will need a screwdriver to connect these devices to your controller.

Table 5-2 Equipment Needed

Type of Input	Equipment Needed
Thermocouple Inputs (Ice Bath)	<ul style="list-style-type: none"> • A calibrating device with at least ± 0.02 % accuracy for use as a signal source such as a millivolt source. • Thermocouple extension wire that corresponds with the type of thermocouple that will be used with the controller input. • Two insulated copper leads for connecting the thermocouple extension wire from the ice baths to the mV source. • Two containers of crushed ice or a commercially available ice bath.
Thermocouple Inputs (T/C Source)	<ul style="list-style-type: none"> • A calibrating device with at least ± 0.02 % accuracy for use as a signal source such as a millivolt source. • Thermocouple extension wire that corresponds with the type of thermocouple that will be used with controller input.

Type of Input	Equipment Needed
RTD (Resistance Thermometer Device)	<ul style="list-style-type: none">• A decade box, with at least ± 0.02 % accuracy, capable of providing stepped resistance values with a resolution of 0.001 ohm over the range of resistance needed.• Three insulated copper leads of equal length for connecting the decade box to the controller.
Milliampere, Millivolt, Volts, and Radiomatic	<ul style="list-style-type: none">• A calibrating device with at least ± 0.02 % accuracy for use as a signal source.• Two insulated copper leads for connecting the calibrator to the controller.• Place current source at zero before switching ON.• Do not switch current sources OFF/ON while connected to the instrument.

5.4 Input Set Up Wiring

5.4.1 Thermocouple Inputs Using an Ice Bath

Refer to Figure 5-2 and wire the controller according to the procedure given in Table 5-3.

Table 5-3 Set Up Wiring Procedure for Thermocouple Inputs Using an Ice Bath

Step	Action
1	Connect the copper leads to the calibrator.
2	<p>If using a physical Ice Bath: Connect a length of thermocouple extension wire to the end of each copper lead and insert the junction points into the ice bath.</p> <p>If using a commercial Ice Bath: Connect a length of thermocouple extension wire to the output side of the Ice Bath. Connect the calibrator with copper wires to the input side of the Ice Bath.</p>
3	Connect the thermocouple extension wires to the terminals for the input to be calibrated. See Figure 5-2.

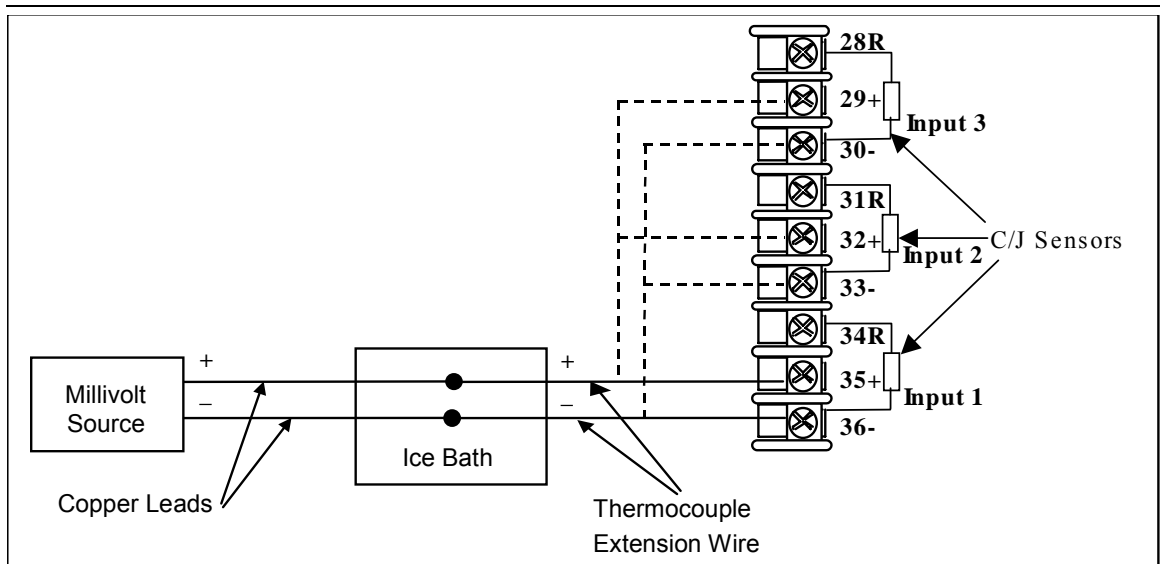

Figure 5-2 Wiring Connections for Thermocouple Inputs Using an Ice Bath

5.4.2 Thermocouple Inputs Using a Thermocouple Source

Refer to Figure 5-3 and wire the controller according to the procedure given in Table 5-4.

Table 5-4 Set Up Wiring Procedure for Thermocouple Inputs using a Thermocouple Source

Step	Action
1	Connect the thermocouple extension wires to the terminals for the input to be calibrated. See Figure 5-3.

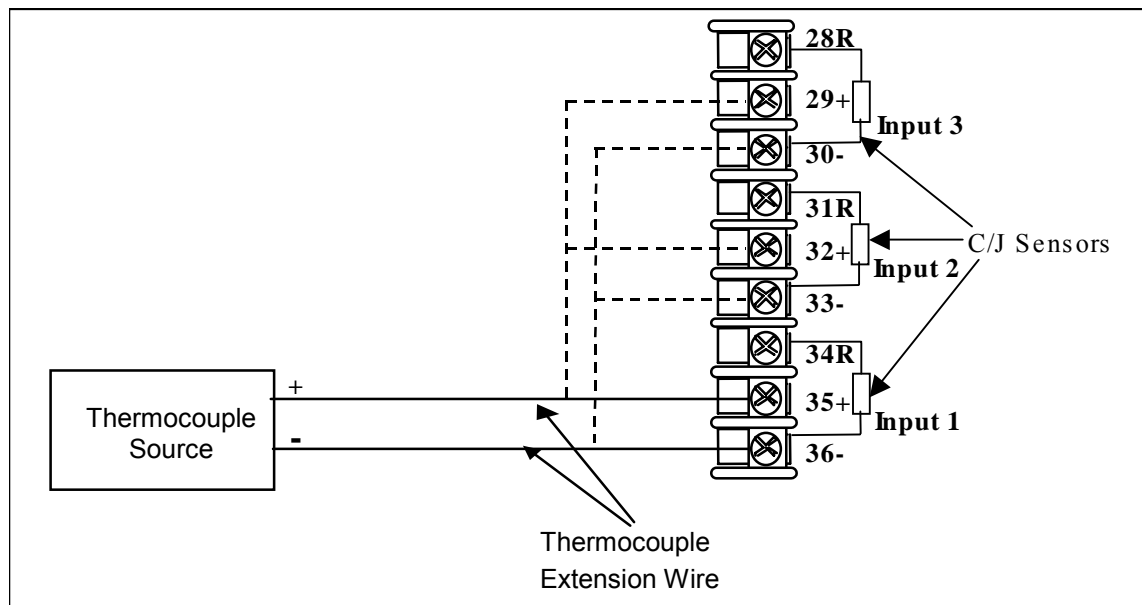

Figure 5-3 Wiring Connections for Thermocouple Inputs Using a Thermocouple Source

5.4.3 RTD Inputs

Refer to Figure 5-4 and wire the controller according to the procedure given in Table 5-5.

Table 5-5 Set Up Wiring Procedure for RTD Inputs

Step	Action
1	Connect the copper wires to the terminals for the input to be calibrated. See Figure 5-4.

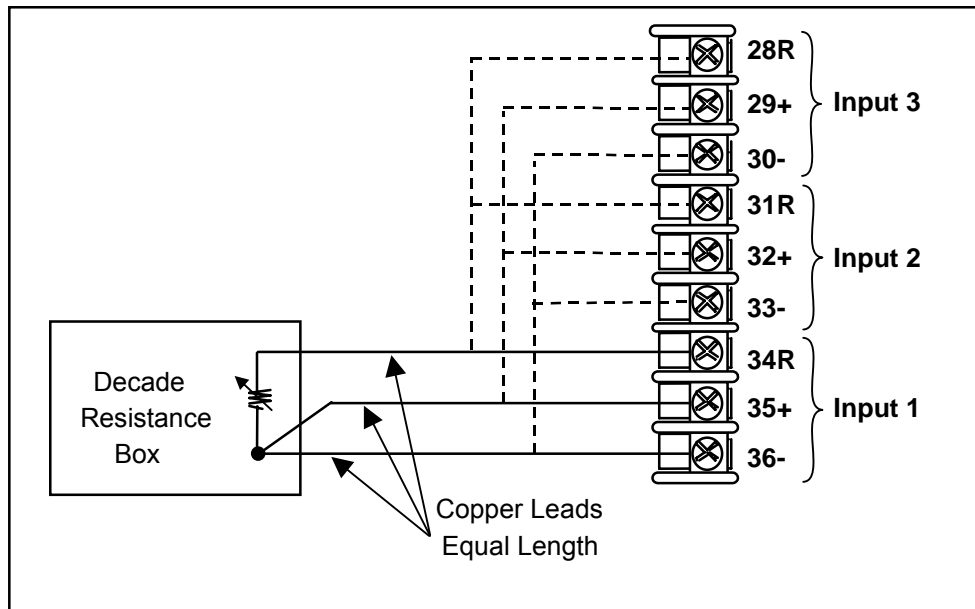

Figure 5-4 Wiring Connections for RTD (Resistance Thermometer Device)

ATTENTION

Decade Resistance Boxes are usually not accurate enough to meet the 0.02% accuracy requirement noted in Table 5-2. This can be overcome by performing a four-wire resistance measurement with a precision DMM and then adjusting the Decade Box to the correct zero and span resistance values as given in Table 5-1. Determine the proper zero and span resistance settings prior to attaching the Decade Box to the instrument. For best accuracy, measure with the DMM connected to the wire ends rather than directly to the Decade Box.

5.4.4 Radiamatic, Millivolts, Volts, Carbon, Oxygen or Thermocouple Differential Inputs

Refer to Figure 5-5 and wire the controller according to the procedure given in Table 5-6.

Table 5-6 Set Up Wiring Procedure for Radiamatic, Millivolts, Volts, Carbon, Oxygen or Thermocouple Differential Inputs (Except 0-10 Volts and -1 to 1 Volts)

Step	Action
1	Connect the copper leads from the calibrator to the Input #1 terminals as shown in Figure 5-5.
2	Place voltage source at zero before switching on.
3	Following calibration, turn off the voltage source prior to disconnecting it from the instrument.

ATTENTION

For Radiamatic inputs only, set Emissivity value to 1.0.

See:

Subsection 3.15 – Configuration Set Up prompt INPUT 1, function prompt EMISSIV 1

Subsection 3.16 – Configuration Set Up prompt INPUT 2, function prompt EMISSIV 2

Subsection 3.17 – Configuration Set Up prompt INPUT 3, function prompt EMISSIV 3

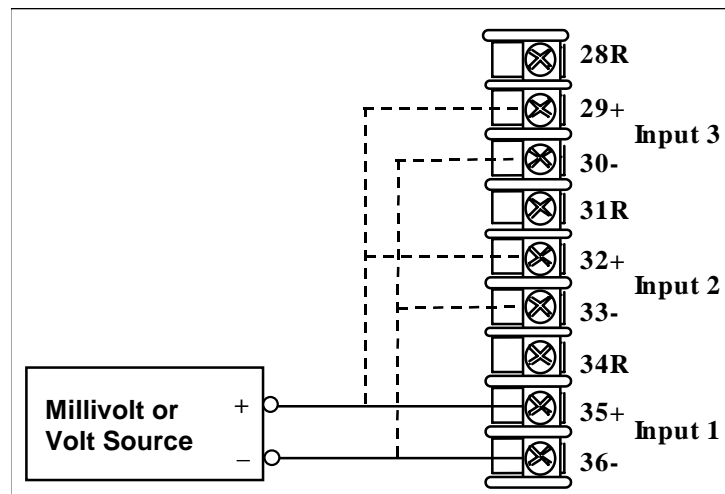

Figure 5-5 Wiring Connections for Radiamatic, Millivolts, Volts, Carbon, Oxygen or Thermocouple Differential Inputs (Except 0-10 Volts and -1 to 1 Volts)

Table 5-7 Procedure to determine calibration voltages for Thermocouple Differential input types other than the Factory Setting

Step	Action
1	Obtain a copy of the ITS-90 Standard for the Thermocouple Type you will be using.
2	Find the thermoelectric voltage for the desired operating temperature.
3	Find the thermoelectric voltages for the temperatures -50°F and $+150^{\circ}\text{F}$ away from the desired operating temperature.
4	The zero calibration voltage will be the thermoelectric voltage for the -50°F temperature minus the thermoelectric voltage for the desired operating temperature. This will be a negative voltage.
5	The span calibration voltage will be the thermoelectric voltage for the $+150^{\circ}\text{F}$ temperature minus the thermoelectric voltage for the desired operating temperature. This will be a positive voltage.

For example: Determine the calibration voltage values for a pair of J-type thermocouples at an operating temperature of 450°F (this is equivalent to the Factory setting).

- The ITS-90 standard for the J thermocouple shows that the thermoelectric voltage for 450°F is 12.568 millivolts.
- The -50°F point would be 400°F . The ITS-90 standard shows that the thermoelectric voltage for 400°F is 11.025 millivolts.
- The $+150^{\circ}\text{F}$ point would be 600°F . The ITS-90 standard shows that the thermoelectric voltage for 600°F is 17.188 millivolts.
- The zero calibration voltage is thus 11.025 minus 12.568 millivolts or -1.543 millivolts (this can be rounded off to -1.54 millivolts without significant loss of accuracy).
- The span calibration voltage is thus 17.188 minus 12.568 millivolts or $+4.62$ millivolts.
- Use -1.54 millivolts for the Zero calibration value and $+4.62$ millivolts for the Span calibration value.

5.4.5 0 to 10 Volts or –1 to 1 Volts

Refer to Figure 5-6 and wire the controller according to the procedure given in Table 5-8.

Table 5-8 Set Up Wiring Procedure for 0 to 10 Volts or –1 to 1 Volts

Step	Action
1	Connect the copper leads from the calibrator to the input to be calibrated as shown in Figure 5-6.
2	Place voltage source at zero before switching on.
3	Following calibration, turn off the voltage source prior to disconnecting it from the instrument.

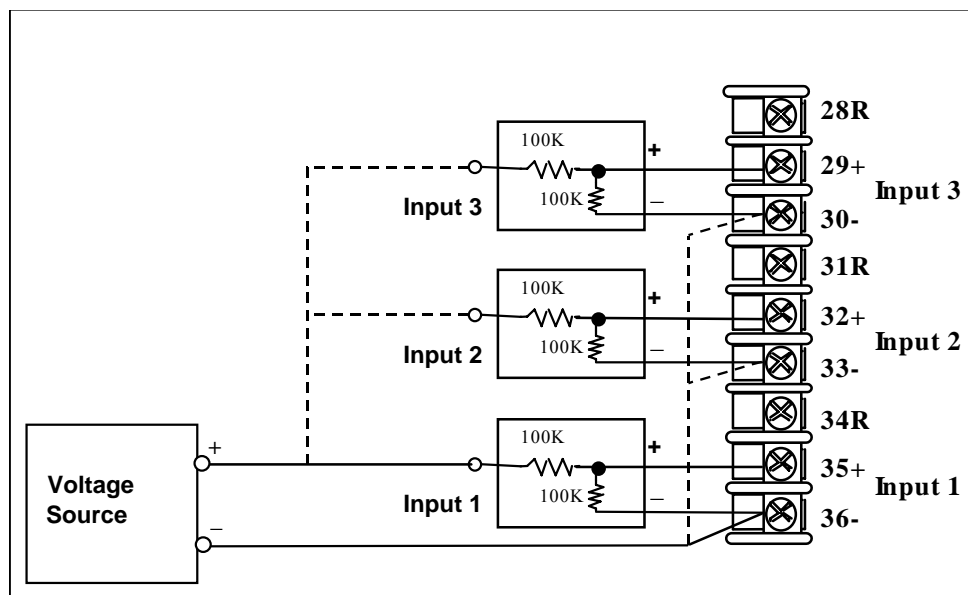

Figure 5-6 Wiring Connections for 0 to 10 Volts or –1 to 1 Volts

5.4.6 Milliampere

Refer to Figure 5-7 and wire the controller according to the procedure given in Table 5-9.

Table 5-9 Set Up Wiring Procedure for Milliampere Inputs

Step	Action
1	Connect the copper leads from the calibrator to the input to be calibrated as shown in Figure 5-7.
2	Place current source at zero before switching on.
3	Following calibration, turn off the current source prior to disconnecting it from the instrument.

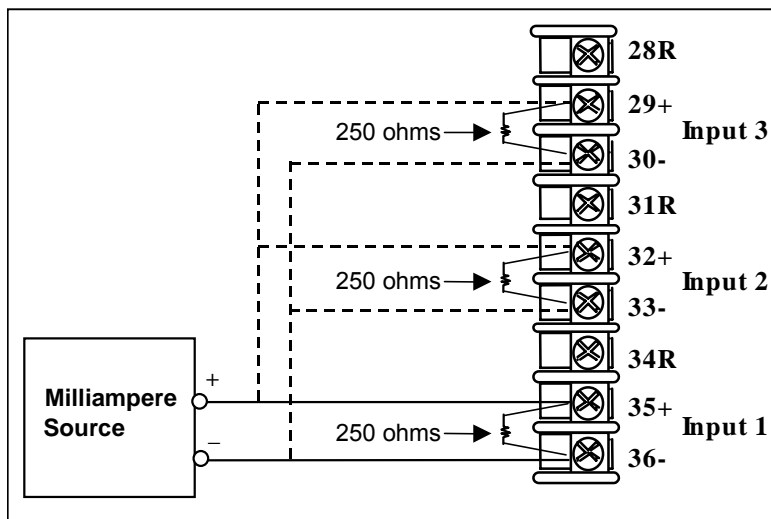

Figure 5-7 Wiring Connections for Milliampere Inputs

5.4.7 Dual High Level Voltage Inputs

Refer to Figure 5-8 and wire the controller according to the procedure given in Table 5-10.

Table 5-10 Set Up Wiring Procedure for Dual High Level Voltage Inputs

Step	Action
1	Connect the copper leads from the calibrator to the input to be calibrated as shown in Figure 5-8.
2	Place voltage source at zero before switching on.
3	Following calibration, turn off the voltage source prior to disconnecting it from the instrument.

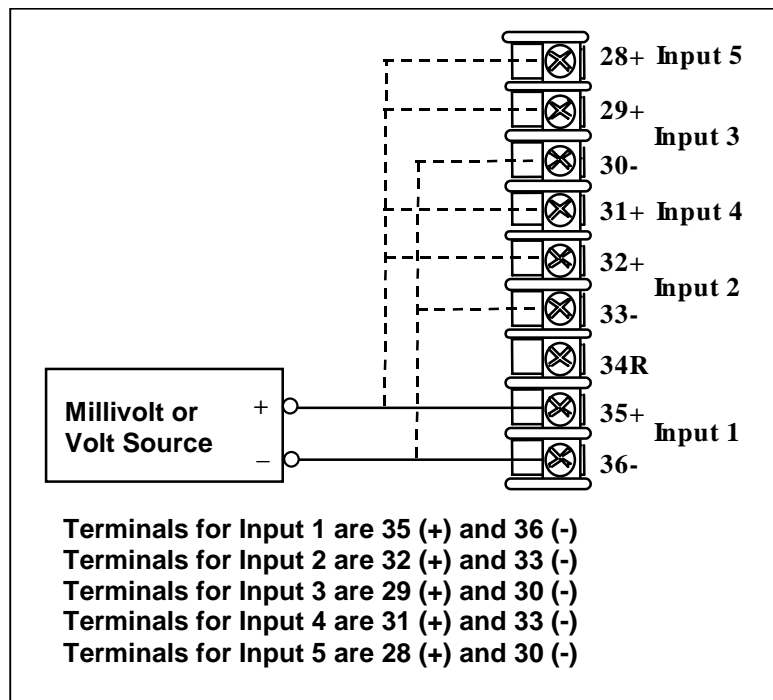

Figure 5-8 Wiring Connections for Dual High Level Voltage Inputs

5.4.8 Dual High Level Milliampere Inputs

Refer to Figure 5-9 and wire the controller according to the procedure given in Table 5-11.

Table 5-11 Set Up Wiring Procedure for Dual High Level Milliampere Inputs

Step	Action
1	Connect the copper leads from the calibrator to the input to be calibrated as shown in Figure 5-9.
2	Place current source at zero before switching on.
3	Following calibration, turn off the current source prior to disconnecting it from the instrument.

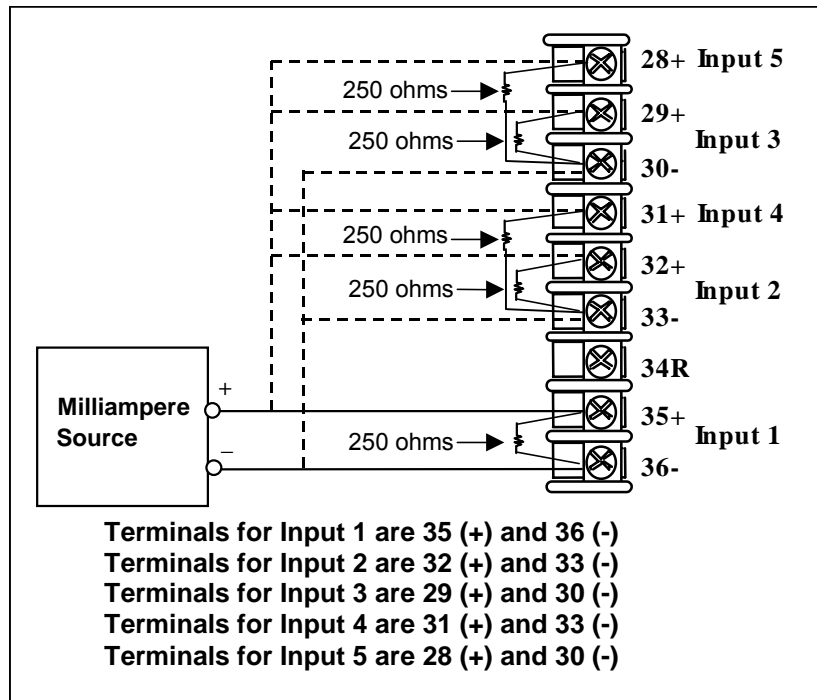

Figure 5-9 Wiring Connections for Dual High Level Milliampere Inputs

5.5 Input Calibration Procedure

Preliminary Steps

- Apply power and allow the controller to warm up for 30 minutes before you calibrate.
- Please read *Subsection 5.3* before beginning the procedure.
- **Make sure you have LOCK set to NONE.** See *Subsection 3.4 – Loop 1 Tuning Set Up Group*.
- See Table 5-1 for Voltage vs. Resistance equivalents or 0 % and 100 % range values.



CAUTION

For linear inputs, avoid step changes in inputs. Vary smoothly from initial value to final 100 % value.

Procedure

The calibration procedure for Input #1 or 2 is listed in Table 5-12.

Table 5-12 Input Calibration Procedure

Step	Operation	Press	Result
1	Enter Calibration Mode	<p>Setup until you see</p> <p>Func Loop 1/2</p> <p> or </p>	<p><i>Upper Display</i> = CALIB <i>Lower Display</i> = INPUTn [n=1 to 5]</p> <p>You will see: <i>Upper Display</i> = DISABLE <i>Lower Display</i> = CAL INn [n=1 to 5]</p> <p>The calibration sequence is enabled and you will see: <i>Upper Display</i> = BEGIN <i>Lower Display</i> = CAL INn [n=1 to 5] At the completion of the sequence, the selection automatically reverts to disable.</p>
2	Calibrate 0 %	Func Loop 1/2	<p>You will see: <i>Upper Display</i> = APPLY <i>Lower Display</i> = INn ZERO [n=1 to 5]</p> <ul style="list-style-type: none"> • Adjust your calibration device to an output signal equal to the 0 % range value for your particular input sensor. See Table 5-1 for Voltage, Degrees, or Resistance equivalents for 0 % range values. • Wait 15 seconds, then go to the next step.

Step	Operation	Press	Result						
3	Calibrate 100 %	Func Loop 1/2	<p>You will see:</p> <p><i>Upper Display</i> = APPLY <i>Lower Display</i> = INn SPAN [n=1 to 5]</p> <ul style="list-style-type: none"> Adjust your calibration device to an output signal equal to the 100 % range value for your particular input sensor. See Table 5-1 for Voltage, Degrees, or Resistance equivalents for 100 % range values. Wait 15 seconds, and <table border="1" style="margin-left: 40px;"> <thead> <tr> <th>If ...</th> <th>Then ...</th> </tr> </thead> <tbody> <tr> <td>you are calibrating a Thermocouple input</td> <td>go to step 4</td> </tr> <tr> <td>you are calibrating other than a Thermocouple input</td> <td>go to step 5</td> </tr> </tbody> </table>	If ...	Then ...	you are calibrating a Thermocouple input	go to step 4	you are calibrating other than a Thermocouple input	go to step 5
If ...	Then ...								
you are calibrating a Thermocouple input	go to step 4								
you are calibrating other than a Thermocouple input	go to step 5								
4	Check the Cold Junction Temperature	Func Loop 1/2	<p>The calculations for zero and span are now stored and you will see:</p> <p><i>Upper Display</i> = The temperature of the Cold Junction Sensor mounted on the rear terminals <i>Lower Display</i> = CJTEMP</p> <p>The value in the upper display is in tenths of a degree. It is the current reading of the cold junction temperature as measured by the controller. This value can be changed by using the ▲ and ▼ keys.</p> <p>WARNING It is recommended that this value not be changed under normal circumstances. Changing this value will not change the thermocouple reading on your instrument. Instead, it changes the effect of cold junction temperature compensation for future ambient temperature changes. If you wish to adjust the temperature reading of your instrument following a Field Calibration, then use the Input Bias setting. See Section 3.15 (Input 1), Section 3.16 (Input 2) or Section 3.17 (Input 3).</p>						
5	Exit the Calibration Mode	Func Loop 1/2 then Lower Display	<p>The controller stores the calibration constants and exits the calibration mode.</p>						

5.6 Restore Input Factory Calibration

Introduction

The factory calibration constants for all the input actuation types that can be used with the controller are stored in its non-volatile memory. Thus, you can quickly restore the “Factory Calibration” for a given input actuation type by simply changing the actuation type to another type and then changing it back to the original type.

Refer to Table 5-13 Restore Factory Calibration for procedure





ATTENTION

A restored factory calibration overwrites any previous field calibration done for the input and may change the High and Low Range Limits.



Protect your field calibration from accidental overwrites by configuring the appropriate LOCKOUT selection after calibration.

See *Section 3 – Configuration* for specific instructions to set the lockout.

Table 5-13 Restore Factory Calibration

Step	Operation	Press	Result
1	Set LOCKOUT to NONE	Setup	until you see: <i>Upper Display</i> = SET UP <i>Lower Display</i> = TUNING
		Func Loop 1/2	Until you see: <i>Upper Display</i> = one of the following: NONE – all parameters are read/write CALIB – all parameters are read/write except Calibration +CONF – configuration parameters are Read Only; no writes permitted +VIEW – Tuning and Setpoint Ramp parameters are read/write. No other parameters can be viewed. ALL – Tuning and Setpoint Ramp parameters are available for read only. No other parameters can be viewed. <i>Lower Display</i> = LOCKOUT
2	Enter INPUT Setup Group	 or 	Until NONE is in the upper display
		Setup	until you see: <i>Upper Display</i> = SET UP <i>Lower Display</i> = INPUT n n = 1 to 5
3	Scroll through Functions	Func Loop 1/2	until you see: <i>Upper Display</i> = the current selection <i>Lower Display</i> = INn TYPE n = 1 to 5
		 or 	to change the current selection to another selection
		Func Loop 1/2	until the lower display rolls through the rest of the functions and returns to: <i>Upper Display</i> = the new selection <i>Lower Display</i> = INn TYPE n = 1 to 5

Input Calibration

Step	Operation	Press	Result
		 or 	until you change the input selection in the upper display back to the proper selection. You will see: <i>Upper Display</i> = Original Input Selection that matches your type of sensor. <i>Lower Display</i> = INn TYPE n = 1 to 5
4	Return to Normal Operation	Lower Display	to return to Normal operating mode. The factory calibration will be restored. If the problem is not corrected, contact the Honeywell Technical Assistance Center at 1-800-423-9883 USA and Canada

6 Output Calibration

6.1 Overview

Introduction

This section describes the field calibration procedures for the following types of outputs:

- Current Outputs
- Position Proportional Output and Three Position Step Output

What's in this section?

The following topics are covered in this section.

TOPIC	See Page
6.1 Overview	295
6.2 First Current Output Calibration	296
6.3 Second Current Output Calibration	298
6.4 Third Current Output Calibration	300
6.5 Position Proportional and Three Position Step Output Calibration	302
6.6 Restore Factory Output Calibration	305



WARNING—SHOCK HAZARD

OUTPUT CALIBRATION MAY REQUIRE ACCESS TO HAZARDOUS LIVE CIRCUITS, AND SHOULD ONLY BE PERFORMED BY QUALIFIED SERVICE PERSONNEL. MORE THAN ONE SWITCH MAY BE REQUIRED TO DE-ENERGIZE UNIT BEFORE CALIBRATION.

6.2 First Current Output Calibration

Introduction

Calibrate the controller so that the output provides the proper amount of current over the desired range. The controller can provide a current output range of from 0 mA to 21 mA. The controller is usually calibrated at 4 mA for 0 % of output and 20 mA for 100 % of output, but it may be calibrated for any other values between 0 mA and 21 mA. It is not necessary to re-calibrate the controller in order to change from 4 to 20 mA operation over to 0 to 20 mA operation, a simple configuration change is all that is required. See the CO RANGE configuration for First Current Output in *Sub-section 3.14* for details.

Equipment Needed

You will need a standard shop type milliammeter, with whatever accuracy is required, capable of measuring 0 to 20 milliamps.

Calibrator Connections

Refer to Figure 6-1 and wire the controller according to the procedure given in Table 6-1.

Table 6-1 Set Up Wiring Procedure for the First Current Output

Step	Action
1	Apply power and allow the controller to warm up 30 minutes before you calibrate.
2	Set LOCK in the Tuning Set Up group to NONE.
3	Tag and disconnect the field wiring, at the rear of the controller, from terminals 5 (+) and 6 (-). See Figure 6-1.
4	Connect a milliammeter across these terminals.

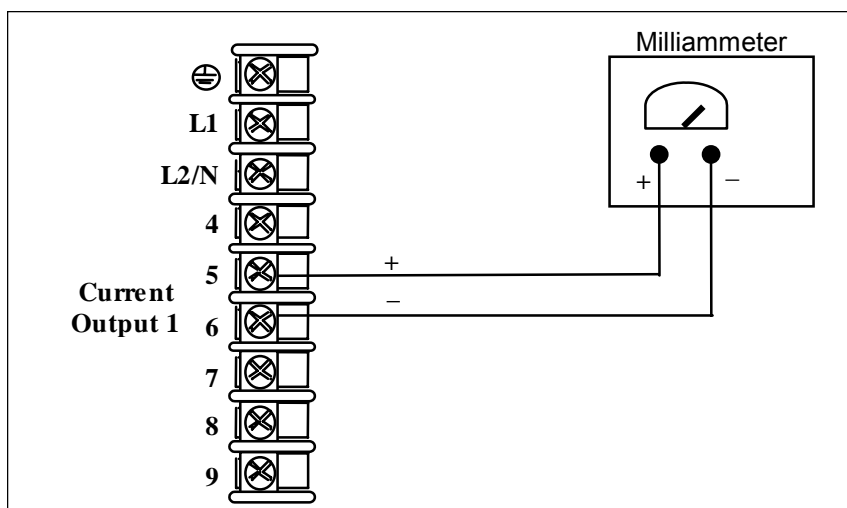





Figure 6-1 Wiring Connections for Calibrating the First Current Output

Procedure

The procedure for calibrating the First Current Output is listed in Table 6-2. Make sure that LOCK in the Tuning Set Up group is set to **NONE**. (See Subsection 3.4 – Loop 1 Tuning Set Up Group.)

Table 6-2 First Current Output Calibration Procedure

Step	Operation	Press	Result
1	Enter Calibration Mode	Setup until you see	<i>Upper Display</i> = CALIB <i>Lower Display</i> = CURRENT
2	Calibrate 0 %	Func Loop 1/2	You will see: <i>Upper Display</i> = A Value <i>Lower Display</i> = ZERO VAL
		 or 	Until the desired 0 % output is read on the milliammeter, use the values shown below depending on the action of your controller. Normally, this will be the setting that produces 4 mA.
3	Calibrate 100 %	Func Loop 1/2	This stores the 0 % value and you will see: <i>Upper Display</i> = A Value <i>Lower Display</i> = SPAN VAL
		 or 	Until the desired 100 % output is read on the milliammeter, use the values shown below depending on the action of your controller. Normally, this will be the setting that produces 20 mA.
4	Exit the Calibration Mode	Func Loop 1/2	The controller stores the span value.
		Lower Display	To exit the calibration mode.

6.3 Second Current Output Calibration

Introduction

Calibrate the controller so that the output provides the proper amount of current over the desired range. The controller can provide a current output range of from 0 mA to 21 mA. The controller is usually calibrated at 4 mA for 0 % of output and 20 mA for 100 % of output, but it may be calibrated for any other values between 0 mA and 21 mA. It is not necessary to re-calibrate the controller in order to change from 4 to 20 mA operation over to 0 to 20 mA operation, a simple configuration change is all that is required. See the CO RANGE configuration for Second Current Output in *Sub-section 3.22* for details.

Equipment Needed

You will need a calibrating device with whatever accuracy is required, capable of measuring 0 to 20 mA.

Calibrator Connections

Refer to Figure 6-2 and wire the controller according to the procedure given in Table 6-3.

Table 6-3 Set Up Wiring Procedure for the Second Current Output

Step	Action
1	Apply power and allow the controller to warm up 30 minutes before you calibrate.
2	Set LOCK in the Tuning Set Up group to NONE.
3	Tag and disconnect the field wiring, at the rear of the controller, from terminals 24 (+) and 25 (-). See Figure 6-2.
4	Connect a milliammeter across these terminals.

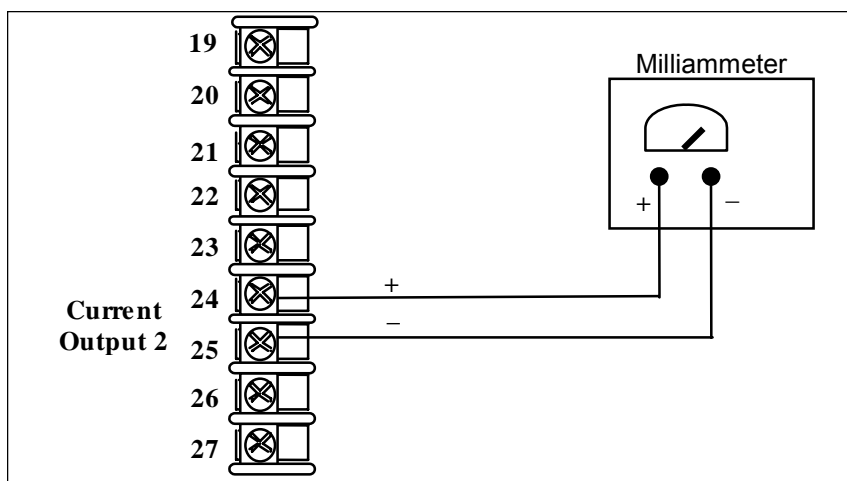





Figure 6-2 Wiring Connections for Calibrating the Second Current Output

Procedure

The procedure for calibrating the Second Current Output is listed in Table 6-4.

Make sure that “LOCK” in the Tuning Set Up group is set to “NONE” (see *Subsection 3.4*).

Table 6-4 Second Current Output Calibration Procedure

Step	Operation	Press	Result
1	Enter Calibration Mode	Setup until you see	<i>Upper Display</i> = CALIB <i>Lower Display</i> = CUR OUT2
2	Calibrate 0 %	Func Loop 1/2  or 	You will see: <i>Upper Display</i> = A Value <i>Lower Display</i> = ZERO VAL until the desired 0 % output is read on the milliammeter. Normally, this will be the setting that produces 4 mA.
3	Calibrate 100 %	Func Loop 1/2  or 	To store the 0 % value you will see: <i>Upper Display</i> = A Value <i>Lower Display</i> = SPAN VAL until the desired 100 % output is read on the milliammeter. Normally, this will be the setting that produces 20 mA.
4	Exit the Calibration Mode	Func Loop 1/2 Lower Display	The controller stores the span value. To exit the calibration mode.

6.4 Third Current Output Calibration

Introduction

Calibrate the controller so that the output provides the proper amount of current over the desired range. The controller can provide a current output range of from 0 mA to 21 mA. The controller is usually calibrated at 4 mA for 0 % of output and 20 mA for 100 % of output, but it may be calibrated for any other values between 0 mA and 21 mA. It is not necessary to re-calibrate the controller in order to change from 4 to 20 mA operation over to 0 to 20 mA operation; a simple configuration change is all that is required. See the CO RANGE configuration for Third Current Output in *Sub-section 3.22* for details.

Equipment Needed

You will need a calibrating device with whatever accuracy is required, capable of measuring 0 to 20 mA.

Calibrator Connections

Refer to Figure 6-3 and wire the controller according to the procedure given in Table 6-5.

Table 6-5 Set Up Wiring Procedure for the Third Current Output

Step	Action
1	Apply power and allow the controller to warm up 30 minutes before you calibrate.
2	Set LOCK in the Tuning Set Up group to NONE.
3	Tag and disconnect the field wiring, at the rear of the controller, from terminals 7 (+) and 9 (-). See Figure 6-3.
4	Connect a milliammeter across these terminals.

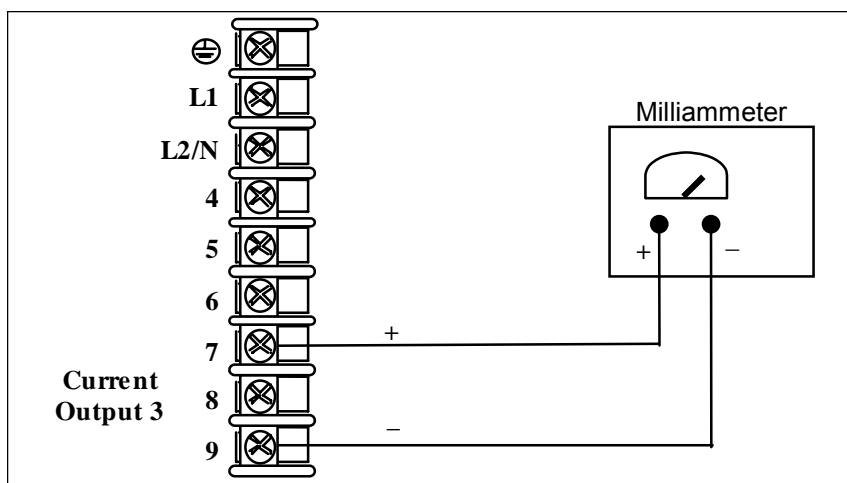





Figure 6-3 Wiring Connections for Calibrating Third Current Output

Procedure

The procedure for calibrating the Third Current Output is listed in Table 6-6.

Make sure that “LOCK” in the Tuning Set Up group is set to “NONE” (see *Subsection 3.4*).

Table 6-6 Third Current Output Calibration Procedure

Step	Operation	Press	Result
1	Enter Calibration Mode	Setup until you see	<i>Upper Display</i> = CALIB <i>Lower Display</i> = CUR OUT3
2	Calibrate 0 %	Func Loop 1/2	You will see: <i>Upper Display</i> = A Value <i>Lower Display</i> = ZERO VAL
		 or 	until the desired 0 % output is read on the milliammeter. Normally, this will be the setting that produces 4 mA.
3	Calibrate 100 %	Func Loop 1/2	To store the 0 % value you will see: <i>Upper Display</i> = A Value <i>Lower Display</i> = SPAN VAL
		 or 	until the desired 100 % output is read on the milliammeter. Normally, this will be the setting that produces 20 mA.
4	Exit the Calibration Mode	Func Loop 1/2 Lower Display	The controller stores the span value. To exit the calibration mode.

6.5 Position Proportional and Three Position Step Output Calibration

Position Proportional control

Position Proportional Control Output Models

Enter the “Motor Time” as shown in Section 3.14. This model must have its output calibrated per the entire procedure to ensure the displayed output (slidewire position) agrees with the final control element position.

Three position step control

Three Position Step Control Output Models not using slidewire feedback.

This model only requires that the “Motor Time” be entered as shown in Section 3.14.

Three Position Step Control Models using slidewire feedback.

Enter the “Motor Time” as shown in Section 3.14. This model must have its output calibrated per the entire procedure to ensure the displayed output (slidewire position) agrees with the final control element position.

Equipment needed

None.

Connections

Apply power and leave all field wiring connected to the rear terminals.





Procedure

The procedure for calibrating the Three Position Step or Position Proportional control is listed in Table 6-7.

Make sure LOCKOUT in Tuning Set Up group is set to NONE. See *Subsection 3.4*.

ATTENTION For Three Position Step Control (TPSC), these prompts *only* appear when “SLIDEW” or “SW EMUL” is selected in the INPUT 3 Setup group. For Position Proportional Control, the Output algorithm must also be configured for “POSPROP”. The Motor Time must be entered in the Output Algorithm Group for both Position Proportional or for Three Position Step control. See Section 3.14 for details.

Table 6-7 Position Proportional and Three Position Step Output Calibration Procedure

Step	Description	Press	Action						
1	Enter Calibration Mode	Setup	<p>until you see</p> <p><i>Upper Display = CALIB</i> <i>Lower Display = POS PROP</i></p>						
2	Select Automatic or Manual Calibration	Func Loop 1/2	<p>continued</p> <p>until you see:</p> <p><i>Upper Display = DISABLE</i> <i>Lower Display = POS PROP</i></p> <p>You can calibrate the controller output manually or let the controller calibrate the output automatically.</p> <p>If the slidewire has never been calibrated, you must use DO AUTO first. In the "Automatic Calibration Mode" (DO AUTO), the controller relays automatically move the motor in the proper direction.</p> <p>If desired, however, the motor may be manually positioned to 0 % and 100 % positions. Disconnect the relay wires. Use DO MAN. In the "Manual Calibration Mode" (DO MAN), the motor does not move. Instead, the existing 0 % and 100 % values may be changed with the  or  key.</p> <p> or  to select automatic or manual calibration.</p> <p><i>Upper Display = DO AUTO or DO MAN</i> <i>Lower Display = POS PROP</i></p> <table border="1" data-bbox="863 1230 1399 1335"> <thead> <tr> <th>If you select...</th> <th>Then...</th> </tr> </thead> <tbody> <tr> <td>DO AUTO</td> <td>go to Step 3</td> </tr> <tr> <td>DO MAN</td> <td>go to Step 5</td> </tr> </tbody> </table>	If you select...	Then...	DO AUTO	go to Step 3	DO MAN	go to Step 5
If you select...	Then...								
DO AUTO	go to Step 3								
DO MAN	go to Step 5								
3	DO AUTO Set 0 % value	Func Loop 1/2	<p>ATTENTION When calibration is terminated, this selection reverts to DISABLE.</p> <p>The decrement relay is turned on to move the motor to 0 % position.</p> <p><i>Upper Display =</i> (counts of slidewire feedback 0-3000) <i>Lower Display = ZERO VAL</i></p> <p>When the motor stops, the display should stop counting. When that happens, go to Step 7.</p>						

Output Calibration

Step	Description	Press	Action
4	DO AUTO Set 100 % value	Func Loop 1/2	The increment relay is turned on to move the motor to 100 % position. <i>Upper Display =</i> (counts of slidewire feedback 0-3000) <i>Lower Display = SPAN VAL</i> When the motor stops, the display should stop counting. When that happens, go to Step 7.
5	DO MAN Set 0 % value	Func Loop 1/2	You will see: <i>Upper Display =</i> (the existing zero calibration value in counts)) <i>Lower Display = ZERO VAL</i>
		▲or▼	until the desired zero value is reached in the upper display. <i>Upper Display =</i> (the desired zero calibration value) <i>Lower Display = ZERO VAL</i>
6	DO MAN Set 100 % value	Func Loop 1/2	The controller will store the 0 % value and you will see: <i>Upper Display =</i> (the existing span calibration value in counts)) <i>Lower Display = SPAN VAL</i>
		▲or▼	until the desired span value is reached in the upper display. <i>Upper Display =</i> (the desired span calibration value) <i>Lower Display = SPAN VAL</i>
			For manual calibration, the motor does not move from its position prior to the start of Position Proportional calibration.
7	Exit the Calibration Mode	Func Loop 1/2 Lower Display or Setup	The controller will store the 100 % value. To exit the calibration mode

6.6 Restore Factory Output Calibration

Introduction

The factory calibration constants for the Current Outputs are stored in its non-volatile memory. Thus, you can quickly restore the “Factory Calibration” for those outputs by simply changing the CO RANGE setting for that output to the other setting and then changing it back to the original type.





Refer to Table 6-8 Restore Factory Calibration for procedure

ATTENTION



A restored factory calibration overwrites any previous field calibration done for the output. Protect your field calibration from accidental overwrites by configuring the appropriate LOCKOUT selection after calibration.

See Section 3 – Configuration for specific instructions to set the lockout.

Table 6-8 Restore Factory Calibration

Step	Operation	Press	Result
1	Set LOCKOUT to NONE	Setup	until you see: <i>Upper Display</i> = SET UP <i>Lower Display</i> = TUNING
		Func Loop 1/2	Until you see: <i>Upper Display</i> = one of the following: NONE – all parameters are read/write CALIB – all parameters are read/write except Calibration +CONF – configuration parameters are Read Only; no writes permitted +VIEW – Tuning and Setpoint Ramp parameters are read/write. No other parameters can be viewed. ALL – Tuning and Setpoint Ramp parameters are available for read only. No other parameters can be viewed. <i>Lower Display</i> = LOCKOUT
		 or 	Until NONE is in the upper display
2	Enter OUTPUT or OPTIONS Setup Group	Setup	until you see: <i>Upper Display</i> = SET UP <i>Lower Display</i> = OUTPUT (for First Current Output) 1. or – <i>Lower Display</i> = OPTIONS (for Second or Third Current Outputs)
		Func Loop 1/2	until you see: <i>Upper Display</i> = the current selection <i>Lower Display</i> = CO RANGE
		 or 	to change the range configuration to the other selection
3	Scroll through Functions	Func Loop 1/2	until the lower display rolls through the rest of the functions and returns to: <i>Upper Display</i> = the new selection <i>Lower Display</i> = CO RANGE

Output Calibration

Step	Operation	Press	Result
		 or 	to change the range selection in the upper display back to the proper selection. You will see: <i>Upper Display</i> = Original range selection <i>Lower Display</i> = CO RANGE
4	Return to Normal Operation	Lower Display	to return to Normal operating mode. The factory calibration will be restored. If the problem is not corrected, contact the Honeywell Technical Assistance Center at 1-800-423-9883 USA and Canada

7 Troubleshooting/Service

7.1 Overview

Introduction

Instrument performance can be adversely affected by installation and application problems as well as by hardware problems. We recommend that you investigate the problems in the following order:

- installation related problems
- application related problems
- hardware and software related problems

and use the information presented in this section to solve them.

What's in this section?

The following topics are covered in this section.

TOPIC		See Page
7.1	Overview	307
7.2	Troubleshooting Aids <ul style="list-style-type: none"> • Overall Error Messages • Controller Failure Symptoms • Customer Support • Determining the Software Version Number 	308
7.3	Power-up Tests	310
7.4	Status Tests	310
7.5	Background Tests	311
7.6	Controller Failure Symptoms	316
7.7	Troubleshooting Procedures <ul style="list-style-type: none"> • Power Failure • Current Proportional Output Failure • Position Proportional Output Failure • Time Proportional Output Failure • Time/Current – Current/Time Proportional Output 	317 318 318 320 323 324
	Failure <ul style="list-style-type: none"> • Alarm Relay Output Failure • Keyboard Failure • Analog Input Failure • RS-485 Communications Failure 	325 326 327 327 330

TOPIC		See Page
	<ul style="list-style-type: none"> • Ethernet Communications Failure • Email Failure 	331
7.8	Restore Factory Configuration	332
7.9	Software Upgrades	333

Installation related problems

Read the Installation section in this manual to make sure the instrument has been properly installed. The installation section provides information on protection against electrical noise, connecting external equipment to the controller, and shielding and routing external wiring.

ATTENTION System noise induced into the controller will result in diagnostic error messages recurring. If the diagnostic error messages can be cleared, it indicates a “soft” failure and is probably noise related.

If system noise is suspected, completely isolate the controller from all field wiring. Use calibration sources to simulate PV and check all controller functions; i.e. Gain, Rate, Reset, Output, Alarms, etc.

See Section 11.3 for further information.

Application related problems

Review the application of the controller; then, if necessary, direct your questions to the local sales office.

Hardware and software related problems

Use the troubleshooting error message prompts and controller failure symptoms to identify typical failures that may occur in the controller. Follow the troubleshooting procedures to correct them.

7.2 Troubleshooting Aids

Overall error messages

An error message can occur:

- At power-up. See Subsection 7.3.
- When the Status Tests are requested. See Subsection 7.4.
- During continuous background tests while in normal operation. See Subsection 7.5.

Controller failure symptoms

Other failures may occur that deal with the Power, Output, or Alarms. Refer to the controller failure symptom in Table 7-4 to determine what is wrong and the troubleshooting procedures to use to correct the problem.

Check installation

If a set of symptoms still persists, refer to *Section 2 – Installation* and ensure proper installation and proper use of the controller in the system.

Customer support

If you cannot solve the problem using the troubleshooting procedures listed in this section, you can get **technical assistance** by dialing 1-800-423-9883 USA and Canada.

An engineer will discuss your problem with you. **Please have your complete model number, serial number and Software version available.** The model and serial numbers can be found on the chassis nameplate. The software version can be viewed under Setup Group “Status.” See Table 7-1.

If it is determined that a hardware problem exists, a replacement controller or part will be shipped with instructions for returning the defective unit.



Do not return your controller without authorization from Honeywell’s Technical Assistance Center or until the replacement has been received.

Check out Honeywell’s **web site** at <http://www.honeywell.com/imc>.

Determining the software version

Table 7-1 lists the procedure for identifying the software version number.

Table 7-1 Procedure for Identifying the Software Version

Step	Operation	Press	Result
1	Select STATUS Set Up Group		Upper Display = READ Lower Display = STATUS
2	Read the software version		You will see: Upper Display = Software version number 35XXX Lower Display = VERSION

Where XXX is the software version number. Please give this number to the Customer Support person. It will indicate which version of software you have and help them determine a solution to your problem.

7.3 Power-up Tests

What happens at power-up

When power is applied, the controller will run three diagnostic tests – Memory (RAM), Calibration and Configuration. After these tests are completed, “TEST DONE” is displayed.

Failsafe Failures

If one or more of these tests fail, the controller will go to the Failsafe Manual Mode, and “FAILSAFE” and one or more diagnostic messages will appear in the lower display. See *Section 7.5 – Background Tests and Diagnostic Messages* for diagnostic procedures.

Position Proportional and Three Position Step test failures

If Auto-calibration has never been performed on a controller configured for Position Proportional or Three Position Step Control with motor position indication, then the diagnostic CAL MTR will appear on the lower display. Refer to *Section 6.5 – Position Proportional and Three Position Step Output Calibration*. This error message is cleared once the slidewire input has been calibrated.

7.4 Status Tests

Introduction

When required, the results of these tests can be checked to determine the reason the controller has gone to Failsafe.

How to check the status tests

The procedure in Table 7-2 tells you how to display the results of the status tests.

Table 7-2 Procedure for Displaying the Status Test Results

Step	Operation	Press	Result
1	Select STATUS Set Up Group	Setup	<i>Upper Display = READ</i> <i>Lower Display = STATUS</i>
2	Read the test results	Func Loop 1/2	You will see: <i>Upper Display = NO or YES</i> YES indicates a failure <i>Lower Display = FAILSAFE</i>
		Func Loop 1/2	<i>Upper Display = PASS or FAIL</i> <i>Lower Display = TEST</i>
3	Cycle through all STATUS Set Up Group prompts	Func Loop 1/2	Continue through the rest of the prompts until you see: <i>Upper Display = READ</i> <i>Lower Display = STATUS</i>

7.5 Background Tests and Diagnostic Messages

Introduction

This instrument performs ongoing background tests to verify data and memory integrity. If there is a malfunction, a diagnostic message will be displayed (blinking) in the lower display.

In the case of simultaneous malfunctions, the messages will appear in sequence in the lower display. Table 7-3 lists these background tests in order by their priority, the reason for their failure, and how to correct the problem.

Diagnostic messages may be suppressed (stop the blinking) by pressing the RUN/HOLD key. The messages will still be available for viewing by pressing the LOWER DISPLAY key. If the underlying condition has not been corrected, then the next time the instrument is powered-down/powered-up, the diagnostic message will return.

Table 7-3 Background Tests

Lower Display	Reason for Failure	How to Correct the Problem
RAM ERR	RAM test failed at start up.	<ol style="list-style-type: none"> 1) Run through STATUS check to determine the reason for the failure. 2) Run through the STATUS check a second time to see if the error cleared. 3) Power cycle the instrument. If the message reappears, replace the instrument.
CAL ERR	Calibration test failed at start up.	<ol style="list-style-type: none"> 1) Run through STATUS check to determine the reason for the failure. 2) Restore factory settings. (See Section 7.8). 3) Power cycle the instrument. If the message reappears, replace the instrument.
EE FAIL	Unable to write to non-volatile memory. Anytime you change a parameter and it is not accepted, you will see EE FAIL.	<ol style="list-style-type: none"> 1) Check the accuracy of the parameter and re-enter. 2) Try to change something else in configuration. 3) Run through Read STATUS tests to re-write to EEPROM. 4) Run through the STATUS check a second time to see if the error cleared. If error did not clear, then power cycle the instrument. If the message reappears, replace the instrument.

Lower Display	Reason for Failure	How to Correct the Problem
CFG ERR	Configuration data is in error.	<ol style="list-style-type: none"> 1) Step through the STATUS group – the controller will recalculate the checksum. 2) Run through the STATUS check a second time to see if the error cleared. 3) Power cycle the instrument. <ol style="list-style-type: none"> a) If the message reappears, replace the instrument. b) If the error does not reappear, check the configuration of your instrument to ensure that it is configured properly. See Section 3.
FAILSAFE or FAILSF 2	This error message shows whenever the controller goes into a failsafe mode of operation. This will happen if: <ul style="list-style-type: none"> • Burnout for input(s) used for PV configured for “None” and input(s) failed. • RAM test failed • Configuration test failed • Calibration test failed 	<ol style="list-style-type: none"> 1) If an input failure message is also being displayed, then see the Analog Input Trouble Shooting Procedure in Section 7.7.8. 2) Run through STATUS check to determine the reason for the failure. 3) Run through the STATUS check a second time to see if the error cleared.
INP1 RNG	Input 1 out of range.	Input exceeds the permissible range as defined in Table 5-1. See the Trouble Shooting Procedure in Section 7.7.8.
INP1FAIL	Two consecutive failures of input 1 integration or input value is outside of Out-of-Range limits; i.e., instrument cannot perform analog to digital conversion.	Analog to Digital conversion failures will happen if: <ul style="list-style-type: none"> • Input sensor is open (Burnout) • Input not configured correctly for the sensor being used • Input source is grossly out of range • Input sensor incorrectly connected to input terminals See the Trouble Shooting Procedure in Section 7.7.8.
INP2 RNG	Input 2 out of range.	Same as INP1RNG above.
INP2FAIL	Two consecutive failures of input 2 integration; i.e., cannot make analog to digital conversion.	Same as INP1FAIL above.
INP3 RNG	Input 3 out of range.	Same as INP1RNG above.
INP3FAIL	Two consecutive failures of input 3 integration; i.e., cannot make analog to digital conversion.	Same as INP1FAIL above.
INP4 RNG	Input 4 out of range.	Same as INP1RNG above.
INP4FAIL	Two consecutive failures of input 4 integration; i.e., cannot make analog to digital conversion.	Same as INP1FAIL above.
INP5 RNG	Input 5 out of range.	Same as INP1RNG above.

Lower Display	Reason for Failure	How to Correct the Problem
INP5FAIL	Two consecutive failures of input 5 integration; i.e., cannot make analog to digital conversion.	Same as INP1FAIL above.
CONF ERR	<ul style="list-style-type: none"> • PV low limit is > PV high limit • SP low limit is > SP high limit • Output low limit is > Output high limit 	Check the configuration for each item and reconfigure as necessary.
PV LIMIT	PV out of range. PV = INP1 x RATIO1+ INP1 BIAS	<ol style="list-style-type: none"> 1) Make sure the input signal is correct. 2) Make sure the Ratio and Bias settings are correct. 3) Recheck the calibration. Use Bias of 0.0
RV LIMIT	The result of the formula shown below is beyond the range of the remote variable. RV = INP2 X RATIO + BIAS	<ol style="list-style-type: none"> 1) Make sure the input signal is correct. 2) Make sure the Ratio2 and Bias2 settings are correct. 3) Recheck the calibration. Use a Ratio2 of 1.0 and a Bias2 of 0.0.
RH LOW	RH Excessive Temperature Depression – Calculated %RH is less than 0%.	<ol style="list-style-type: none"> 1) Make sure the input signals are correct. 2) Make sure the Ratio and Bias settings are correct for each input. 3) Recheck the calibration. Use Bias of 0.0
SEGERR	Setpoint Program start segment number is less than ending segment number.	Check SP Program configuration, subsection 3.6 Set up Group SPPROG function prompts “STRSEG” and “ENDSEG”.
CAL MTR	Slidewire calibration never performed.	Field Calibrate the slidewire. See Section 6.5.
SW FAIL	Position Proportional slidewire input failure.	See the Trouble Shooting Procedure in Section 7.7.3.
SOOTING	Percent Carbon falls outside sooting boundary	Check process for correct operation.
TCx WARN	The Thermocouple on Input x (1 or 2 or 3) is starting to burnout.	The controller has detected that the thermocouple is starting to burnout. This error message may also be created if the resistance of the wires used to connect the thermocouple to the instrument is above 100 ohms (50 ohms per leg).
TCxFail	The Thermocouple on Input x (1 or 2 or 3) is in imminent danger of burning out.	The controller has detected that the thermocouple will soon fail. User should consider replacing the thermocouple as soon as possible. This message will also be generated if the resistance of the wires used to connect the thermocouple to the instrument is above 180 ohms (90 ohms per leg).

Lower Display	Reason for Failure	How to Correct the Problem
OUT1FAIL	First Current Output is less than 3.5 mA.	First Current Output is open circuit. Check the field wiring. See the Trouble Shooting Procedure in Section 7.7.2. All Output Fail diagnostic messages may be permanently suppressed via the DIAGNOST configuration in the Alarm Setup Group. See Section 3.24.
OUT2FAIL	Second Current Output is less than 3.5 mA.	Second Current Output is open circuit. Check the field wiring. See the Trouble Shooting Procedure in Section 7.7.2. All Output Fail diagnostic messages may be permanently suppressed via the DIAGNOST configuration in the Alarm Setup Group. See Section 3.24.
OUT3FAIL	Third Current Output is less than 3.5 mA.	Third Current Output is open circuit. Check the field wiring. See the Trouble Shooting Procedure in Section 7.7.2. All Output Fail diagnostic messages may be permanently suppressed via the DIAGNOST configuration in the Alarm Setup Group. See Section 3.24.
CLOCKERR	Real Time Clock values are invalid.	Check the Real Time Clock Settings. See Section 3.25. Entering “YES” to “SET CLOCK?” will clear the error flag.
BATT LOW	Battery Voltage has fallen to unsafe levels.	Replace the Battery Module. See Section 8.1.
EUNPLGED	Ethernet Link is unplugged, incorrectly connected or the Ethernet network is not working.	Check that the Ethernet cable is correctly connected to the instrument and to the host. See Section 2.7 for wiring diagrams. Check Ethernet network for functionality.
ENET DEF	Ethernet parameters are at their default settings (both working and backup copies). IP address is configured at 10.0.0.2.	Configure the Ethernet parameters to their desired values using the P.I.E. Tool. See Section 3.30.
EBRDFAIL	Ethernet Board has failed.	Replace Ethernet Board.
ALRM1SP1	Alarm 1 Setpoint 1 is active.	As required by the alarm application. Alarm messages appear only if ALM MSG is enabled in the Alarm Set Up Group.
ALRM1SP2	Alarm 1 Setpoint 2 is active.	Same as ALRM1SP1.
ALRM2SP1	Alarm 2 Setpoint 1 is active.	Same as ALRM1SP1.
ALRM2SP2	Alarm 2 Setpoint 2 is active.	Same as ALRM1SP1.
ALRM3SP1	Alarm 3 Setpoint 1 is active.	Same as ALRM1SP1.

Lower Display	Reason for Failure	How to Correct the Problem
ALRM3SP2	Alarm 3 Setpoint 2 is active.	Same as ALRM1SP1.
ALRM4SP1	Alarm 4 Setpoint 1 is active.	Same as ALRM1SP1.
ALRM4SP2	Alarm 4 Setpoint 2 is active.	Same as ALRM1SP1.

7.6 Controller Failure Symptoms

Introduction

In addition to the error message prompts, there are failure symptoms that can be identified by noting how the controller displays and indicators are reacting.

Symptoms

Compare your symptoms with those shown in Table 7-4.

Table 7-4 Controller Failure Symptoms

Upper Display	Lower Display	Indicators	Controller Output	Probable Cause	Trouble-shooting Procedure
Blank	Blank	Off	None	Power Failure	7.7.1
OK	Displayed Output disagrees with Controller Output	OK	Controller Output disagrees with Displayed Output	Current Proportional Output	7.7.2
OK		OK		Position Proportional or TPSC Output	7.7.3
OK		OK		Time Proportional Output	7.7.4
OK		OK		Current/Time Proportional Output	7.7.5
OK	OK	OK	External Alarm function does not operate properly	Malfunction in alarm output	7.7.6
OK	Displayed Output disagrees with First Current Output	OK	Controller Current Output #1 disagrees with Displayed First Current Output	First Current Output	7.7.2
OK	Displayed Output disagrees with Second Current Output	OK	Controller Current Output #2 disagrees with Displayed Second Current Output	Second Current Output	7.7.2
OK	Displayed Output disagrees with Third Current Output	OK	Controller Output disagrees with Displayed Third Current Output	Third Current Output	7.7.2
Display does not change when a key is pressed				Keyboard Malfunction	7.7.7

Upper Display	Lower Display	Indicators	Controller Output	Probable Cause	Troubleshooting Procedure
Controller fails to go into "Slave" operation during communications				Communications Failure	RS-485: 7.7.8 Ethernet: 7.7.10
Bad PV Reading	Bad In X Reading	OK	OK	Analog Input Failure	7.7.8

Other symptoms

If a set of symptoms or prompts other than the one you started with appears while troubleshooting, re-evaluate the symptoms. This may lead to a different troubleshooting procedure.

If the symptom still persists, refer to the installation section in this manual to ensure proper installation and proper use of the controller in your system.

7.7 Troubleshooting Procedures

Introduction

The troubleshooting procedures are listed as they appear in Table 7-4. Each procedure describes what to do if you have that particular failure and how to do it or where to find the data needed to accomplish the task.



WARNING—SHOCK HAZARD

TROUBLESHOOTING MAY REQUIRE ACCESS TO HAZARDOUS LIVE CIRCUITS AND SHOULD ONLY BE PERFORMED BY QUALIFIED SERVICE PERSONNEL. MORE THAN ONE SWITCH MAY BE REQUIRED TO DE-ENERGIZE UNIT BEFORE SERVICING.

Equipment needed

You will need the following equipment in order to troubleshoot the symptoms listed:

- Multimeter – Capable of measuring millivolts, volts, milliamps and resistance.
- Calibration sources – T/C, mV, Volt, etc.

7.7.1 Procedure #1 – Power

Table 7-5 explains how to troubleshoot power failure symptoms.

Table 7-5 Troubleshooting Power Failure Symptoms

Step	What to do	How to do it
1	Check the AC or DC line voltage.	Use a voltmeter to measure the AC or DC voltage across terminals L1 and L2 on the rear terminal panel of the controller. Check the earth ground connection.
2	Make sure the chassis plugs into the rear of the case properly.	Withdraw the chassis and visually inspect the controller board and the inside of the case. Reseat the boards into the Chassis if necessary.
3	Check the system for Brownouts, heavy load switching, etc., and conformance to installation instructions.	Refer to <i>Section 2 – Installation</i> .
4	Change Power board.	Installation instructions supplied with new board.

7.7.2 Procedure #2 – Current Outputs

Table 7-6 explains how to troubleshoot Current Output failure symptoms.

Table 7-6 Troubleshooting Current Output Failure

Step	What to do	How to do it
1	Make sure that the controller is configured correctly and that the proper range (4 to 20 or 0 to 20) is configured.	Refer to <i>Section 3 – Configuration</i> . Configuration incorrect: Fix configuration Configuration correct: Go to Step 2.
2	Check the field wiring.	Output impedance must be less than or equal to 1000 ohms.
3a	First Current Output: Test for operation.	Change Output Set Up group function prompt OUT ALG = CUR. Make the Output Set up group function prompt CO RANGE = 4–20 Go to Step 4
3b	Second Current Output: Test for operation.	Change Options Set Up group function prompt CUR2 OUT = OUTPUT Make the Current #2 Options Set up group function prompt CO RANGE = 4–20 Go to Step 4

Step	What to do	How to do it
3c	Third Current Output: Test for operation.	<p>Change Options Set Up group function prompt CUR3 OUT = OUTPUT</p> <p>Make the Current #3 Options Set up group function prompt CO RANGE = 4–20</p> <p>Go to Step 4</p>
4	Check the output.	<p>Put the controller into Manual mode and change the output via the front keyboard from 0 % to 100 %. Use a DC milliammeter at the rear terminals for the output being diagnosed to verify the output.</p> <p>Output works correctly: Return the controller to its original configuration and check output again.</p> <p>Output does not work correctly: Go to Step 5.</p>
5	Restore Factory Calibration	<p>For the output being diagnosed, change the CO RANGE prompt from its present setting to its other setting. Exit the setup group and then return and change CO RANGE back to its previous setting.</p> <p>Output works correctly: Finished</p> <p>Output does not work correctly: Go to Step 6.</p>
6	Field Calibrate the output.	<p>Refer to <i>Section 1 – Output Calibration</i> for details.</p> <p>Output works correctly: Finished</p> <p>Output does not work correctly: Go to Step 7.</p>
7	Change Current Output board.	<p>Installation instructions provided with new board.</p>

7.7.3 Procedure #3 – Position Proportional

Table 7-7 explains how to troubleshoot Position Proportional Output failure symptoms.

Table 7-7 Troubleshooting Position Proportional Output Failure

Step	What to do	How to do it
1	Make certain that the controller is configured properly for Position Proportional output.	<p>Make Output Algorithm Set Up group function prompt OUT ALG = POSPROP.</p> <p>Make Input 3 Set Up group function prompt IN3 TYPE = SLIDEW or EU SLIDE (depending upon slidewire type)</p> <p>Refer to <i>Section 3 – Configuration</i>.</p> <p>If the “CAL MTR” diagnostic prompt is flashing on the lower display, then this means that the instrument was never calibrated for your application. See the Position Proportional field calibration procedure in <i>Section 1 – Output Calibration</i> for motor slidewire calibration procedure.</p>
2	Check the field wiring.	Refer to <i>Section 2 – Installation</i> for details.
3	Check whether the motor drives in both directions.	<p>Put the controller into Manual mode. Vary the output above and below the present value. Observe “OUT” indicators and the output value (“OUT”) on the lower display. When the “OUT 1” indicator is on and the “OUT 2” indicator is off, then the motor should be opening and the output value shown on the lower display should be increasing. When the “OUT 1” indicator is off and the “OUT 2” indicator is on, then the motor should be closing and the output value on the lower display should be decreasing. Listen for a click from a relay when the OUT1 and OUT 2 indicators change state.</p> <p>a) Motor moves in both directions but the displayed Output value does not change or does not have a decimal point – Go to Step 4</p> <p>b) Motor does not move in one or both directions – Go to Step 5</p> <p>c) Motor moves in both directions but the displayed Output value moves in the wrong direction: This means that the motor or the slidewire or both are incorrectly wired. Check the motor manufacturer’s wiring diagram and then refer to <i>Section 2 – Installation</i> to rewire the controller.</p>

Step	What to do	How to do it
4	Motor moves in both directions but the displayed Output value does not change or does not have a decimal point	Slidewire input is malfunctioning. See the Position Proportional field calibration procedure in Section 6.5 for the motor slidewire calibration procedure. Follow that procedure to Field Calibrate the instrument. If after a Field Calibration the problem is still not fixed, then go to Step 6.
5	Motor does not move in one or both directions	Wiring Problem. Check the motor manufacturer's wiring diagram and then refer to <i>Section 2 – Installation</i> to rewire the controller. If wiring is correct, then go to Step 7.
6	Determine if Motor Slidewire or Input 3 is at fault.	<p>Disconnect and tag the field wiring for the slidewire. Refer to <i>Section 2 – Installation</i>. Measure the voltage between the R (28) and the – (30) terminals.</p> <p>Voltage is $+1.2\text{Vdc} \pm 0.2\text{Vdc}$: Bad motor slidewire. Refer to the motor manufacturer's instructions.</p> <p>Voltage not $+1.2\text{Vdc} \pm 0.2\text{Vdc}$: Check the Jumper on the Input 3 Board (see Figure 2-11). Jumper should be in W1 position. If not, then move it to W1 position and recalibrate the instrument per <i>Section 1 – Output Calibration</i>. If the Jumper is in the W1 position, then replace the Input 3 board. Installation instructions supplied with the new board.</p>

Step	What to do	How to do it
7	Check the Relays.	<p>Turn off power to the motor and to the instrument. Disconnect and tag the field wiring to the relays. Relay 1 (MOTOR – OPEN) is on terminals 8 and 9. Relay 2 (MOTOR – CLOSE) is on terminals 7 and 8.</p> <p>Turn on power to the instrument. Put the controller into Manual mode. Connect your multimeter to terminals 8 and 9 and set the multimeter to measure resistance. Now, vary the output above and below the present value and observe the “OUT” indicators and your multimeter. When the “OUT 1” indicator is on, then Relay 1 should be closed and there should be only a few ohms between terminals 8 and 9. When the “OUT 1” indicator is off, then Relay 1 should be open and there should be infinite resistance between terminals 8 and 9. Listen for a click from the relay when the OUT1 indicator changes state.</p> <p>Repeat this test for Relay 2 by connecting your multimeter to terminals 7 and 8. When the “OUT 2” indicator is on, the relay should be closed and there should be only a few ohms between terminals 7 and 8. When the “OUT 2” indicator is off, the relay should be open and there should be infinite resistance between terminals 7 and 8. Listen for a click from the relay when the “OUT 2” indicator changes state.</p> <p><i>Relays measure correctly.</i> Check motor. Refer to manufacturer’s instructions.</p> <p><i>Relays do not measure correctly.</i> Go to Step 8.</p>
8	Replace the Dual Relay Board.	Installation instructions supplied with the new board.

7.7.4 Procedure #4 – Time Proportional

Table 7-8 explains how to troubleshoot Time Proportional Output failure.

Table 7-8 Troubleshooting Time Proportional Output Failure

Step	What to do	How to do it
1	Make sure the controller is configured for Time Proportional output.	Make Output Algorithm Set Up group function prompt OUT ALG (Loop 1) or OUT2 ALG (Loop 2) = RLY or RLYD. Refer to Section 3.14.
2	Check the field wiring.	Make sure the NO or NC contact wiring is correct. Refer to <i>Section 2 – Installation</i> for details.
3	Check the output.	Put the controller into Manual mode. Vary the output above and below the present value. Observe OUT1 indicator (Loop 1) or OUT3 indicator (Loop 2) on the operator interface. Contact should change state. 0 % open, 100 % closed. Listen for a click from the relay when the OUT1 or OUT3 indicator changes state.
4	Check relay.	Change relay.
5	Change relay board.	Installation instructions supplied with the new board.

7.7.5 Procedure #5 – Current/Time or Time Current/Proportional

Table 7-9 explains how to troubleshoot Current/Time or Time/Current Proportional Output failure.

Table 7-9 Troubleshooting Current/Time or Time/Current Proportional Output Failure

Step	What to do	How to do it
1	Make sure the controller is configured for Time/Current or Current/Time Proportional output.	Make Output Algorithm Set Up group function prompt OUT ALG = TCUR or CURT. Refer to <i>Section 3 – Configuration</i> .
2	Check the field wiring.	Make sure the NO or NC contact wiring selection is correct. Refer to <i>Section 2 – Installation</i> for details.
3	Check the relay output.	Put the controller into Manual mode. Vary the output above and below the present value. Observe OUT1 indicator (Loop 1) or OUT3 indicator (Loop 2) on the operator interface. Contact should change state. 0 % open, 100 % closed. Listen for a click from the relay when the OUT1 or OUT3 indicator changes state.
4	Check the Current Proportional Output.	Put the controller into Manual mode and change the output from 0 % to 100 % (4-20 or 0-20 mA). Use a DC milliammeter at the rear terminals to verify the output.
5	Recalibrate the controller.	Refer to <i>Section 1 – Output Calibration</i> for details.
6	Change Current Output or Relay board.	Installation instructions supplied with new board.

7.7.6 Procedure #6 – Alarm Relays

ATTENTION

If the controller is configured to use the same relay for more than one function, then the following priority is used to determine how the relay functions: Control Outputs take precedence over Alarms, which in turn take precedence over Time/Events, which in turn take precedence over Logic Gate Outputs. For example, if you select the Loop 2 Output Algorithm as Time Simplex (which uses Relay 3), enable Alarm 3 (which also uses Relay 3) and configure a Logic Gate to use Relay 3, then the instrument will use Relay #3 to perform the Time Simplex output and ignore the Alarm and Logic Gate functions.

The prompts for the Alarm Outputs appear whether or not the alarm relays are physically present or used for some other function. This allows the Alarm status to be shown on the display and/or sent via communications to a host computer.

Table 7-10 explains how to troubleshoot Alarm Relay Output failure.



Table 7-10 Troubleshooting Alarm Relay Output Failure

Step	What to do	How to do it
1	Check the alarm configuration data. If it is correct, check the field wiring.	Reconfigure if necessary. Refer to <i>Section 3 – Configuration</i> for details.
2	Check that the applicable alarm relay actuates properly depending on what you have set at prompt AxSxTYPE. If it does, check the field wiring.	EXAMPLE: If the alarm type is set for PV, place the controller in manual mode. Vary the input to raise and lower the PV around the alarm setpoint. Listen for a click from the relay as the PV moves in either direction and note that the proper alarm annunciator turns ON and OFF as the PV moves past the alarm setpoint value. EXAMPLE: If the alarm is set for MAN, put the controller into manual mode. The alarm annunciator should be ON. Put the controller into automatic mode and the alarm annunciator should be OFF.
3	Check the contacts.	Make sure the NO or NC contact wiring is correct. Refer to <i>Section 2 – Installation</i> for relay contact information.
4	Change the relay and/or the relay output board.	Installation instructions supplied with the new relay or board.

7.7.7 Procedure #7 – Keyboard

Table 7-11 explains how to troubleshoot a Keyboard failure.

Table 7-11 Troubleshooting a Keyboard Failure

Step	What to do	How to do it
1	Make sure the keyboard is connected properly to the MCU/output and power/input boards.	Withdraw the chassis from the case and visually inspect the connection.
2	Controller Keyboard or specific keys may be LOCKED OUT via the security code.	Use your four-digit security code number to change the lockout level. Refer to Section 3 – Configuration.
3	Run the keyboard test.	<p>Simultaneously press both the</p>  key and the  key. <p>The controller will now run a display test that lights every element in the display. Following that test, you will then see:</p> <div style="text-align: center;"> <p>Upper Display</p> <div style="border: 1px solid black; padding: 2px; display: inline-block;">KEYS</div> <p>Lower Display</p> <div style="border: 1px solid black; padding: 2px; display: inline-block;">TRY ALL</div> </div> <p>Press each key. If instrument reads the key, then the key's name will appear in the lower display. After fifteen seconds, the unit returns to normal operation.</p>
4	Replace the Display/Keyboard Assembly if any keys do not function.	Refer to “Parts Replacement Procedures” in this section.

7.7.8 Procedure #8 – Analog Input

Table 7-12 explains how to troubleshoot an Analog Input failure



Table 7-12 Troubleshooting an Analog Input Failure

Step	What to do	How to do it
1	Check Input Configuration.	Check if the input configurations are correctly set for the kind of sensor attached to the input terminals. See Section 3.15 (Input 1) through Section 3.19 (Input 5).
2	Check input wiring and external resistor assemblies.	See the Input Wiring Diagrams in Section 2.7 and confirm that the instrument is properly connected to the sensor. Thermocouple, Milliamp, 0 to 10 Volt and –1 to 1 Volt input types all require that external resistor assemblies be connected to the input terminals. These are provided with your instrument based upon the Model Number ordered. See the Input Wiring Diagrams in Section 2.7 for installation information.
3	Check interconnection wiring	If the actual sensor does not come directly to the controller but is instead connected via one or more intermediate junction panels, which in turn are connected to the controller, then check the continuity of the sensor to the controller. Check the tightness of the screws or connectors at the junction panels.
4	Check Input Signals.	Turn off power to the instrument (more than one switch may be necessary). Using a multimeter, measure the actual signal present at the rear terminals to ensure that it is within the allowed input range as shown in Section 5.2.
5	Change the Input Type in order to restore Factory Calibration.	See Section 5.6.
6	Replace Input Board.	Installation instructions provided with new board.
7	Replace Controller.	

7.7.9 Procedure #9 – RS-485

Table 7-13 explains how to troubleshoot a RS 485 Communications failure.

Table 7-13 Troubleshooting a RS-485 Communications Failure

Step	What to do	How to do it
1	Check the Address Number, ComState and Baud Rate settings.	See Section 3.23.
2	Check if the controller is wired correctly to the Network.	See Section 2.7 for wiring diagrams.
3	<p>Determine if the Communications board is faulty by running a LOCAL LOOPBACK TEST.</p> <p>If the test fails, replace the board. If the test passes, the problem is most likely elsewhere in the communications network.</p>	<p>Disconnect the communications cable from the rear terminals. Run the Local Loopback Test.</p> <p>Press Setup key until you see:</p> <p style="text-align: center;">Upper Display <div style="border: 1px solid black; padding: 2px; display: inline-block;">SET UP</div> Lower Display <div style="border: 1px solid black; padding: 2px; display: inline-block;">COM</div></p> <p>Press Func-Loop 1/2 key until you see:</p> <p style="text-align: center;">Upper Display <div style="border: 1px solid black; padding: 2px; display: inline-block;">DISABLE</div> Lower Display <div style="border: 1px solid black; padding: 2px; display: inline-block;">LOOPBACK</div></p> <p>Press  or  and you will see:</p> <p style="text-align: center;">Upper Display <div style="border: 1px solid black; padding: 2px; display: inline-block;">ENABLE</div> Lower Display <div style="border: 1px solid black; padding: 2px; display: inline-block;">LOOPBACK</div></p> <p>Press Lower Display key and you will see:</p> <p style="text-align: center;">Upper Display <div style="border: 1px solid black; padding: 2px; display: inline-block;">START</div> Lower Display <div style="border: 1px solid black; padding: 2px; display: inline-block;">LOOPBACK</div></p> <p>Then you will see either PASS or FAIL in the Upper Display. The test will run until the operator disables it or until the unit is power-cycled.</p> <p>If you see FAIL, go to Step 4. If you see PASS, then the problem is most likely not in the instrument, but somewhere else in the network. Reconnect the communications cable and then go to Step 7.</p>

Step	What to do	How to do it
4	Make sure that the Communications Printed Wiring Board is installed properly in the controller.	Withdraw the chassis from the case and inspect the board. See the exploded view (Figure 8-1) for location of the board. Return the chassis to the case and go back to Step 3.
5	Change RS-485 Communications board.	Installation instructions provided with new board.
6	Change Controller	
7	Follow these next two steps if you saw PASS in Step 3. Check the field wiring and termination resistor.	Turn off the power to all instruments on the Network. Using an ohmmeter, check the resistance across the communications rear terminals. See Section 2.7 for wiring diagrams. There should be a reading equivalent to the value of the termination resistors. If not, replace termination resistors.
8	Check the rest of the Network.	

7.7.10 Procedure #10 – Ethernet

Table 7-14 explains how to troubleshoot an Ethernet Communications failure.

Table 7-14 Troubleshooting an Ethernet Communications Failure

Step	What to do	How to do it
1	Check for lower display diagnostic messages	<ul style="list-style-type: none"> • If the lower display is showing the diagnostic message “EUNPLGED” (Ethernet Unplugged), then this means that the Ethernet cable is unplugged, the unit is improperly connected to the network or that the Ethernet network itself is bad. See Section 2.7 for wiring diagrams. If the unit is properly connected, then check the Ethernet network for functionality. • If the lower display is showing the diagnostic message “ENET DEF” (Ethernet Default) then this means that the instrument is set for the factory default IP address of 10.0.0.2. This will appear when the Ethernet parameters have failed (both working and backup copies). See Section 3.30 and re-configure the Ethernet settings with the P.I.E. Tool. • If the lower display is showing the diagnostic message “EBRDFAIL” (Ethernet Board Failure) then this means that there has been a failure on the Ethernet Communications Board. Go to step 3.
2	If none of the above diagnostic messages are present, then check the IP address, Subnet Mask address and Gateway address settings.	As shipped from the factory, all units are configured for an IP address of 10.0.0.2. The MAC address is printed on the product label located on the instrument’s case. Configure the Ethernet and Email settings with the P.I.E. Tool. See Section 3.30.
3	Change Ethernet Communications board.	<p>Installation instructions provided with new board.</p> <p>ATTENTION The replacement Ethernet Communications board will have a label showing its MAC address. To avoid confusion, it is strongly recommended that you change the MAC address shown on the label on your instrument’s case to be the same as the MAC address shown on your new board.</p>
4	Change Controller	

7.7.11 Procedure #11 – Email

Table 7-15 explains how to troubleshoot an Ethernet Communications failure.

Table 7-15 Troubleshooting an Email Failure

Step	What to do	How to do it
1	Check for Ethernet diagnostic messages on lower display	See Diagnostic Procedure #10 – Ethernet, Step #1 in Section 7.7.10.
2	Check the IP address, Subnet Mask address and Gateway address settings. Check the Email “To Email” and “SMTP Address: (for Outgoing)” settings.	As shipped from the factory, all units are configured for an IP address of 10.0.0.2 and a SMTP address of 0.0.0.0. The MAC address is printed on the product label located on the instrument’s case. Configure the Ethernet and Email settings with the P.I.E. Tool. See Section 3.30.
3	Check if the selected Alarm has become active.	Emails are sent only when the selected Alarm transitions from OFF to ON. Depending upon your network, it may take several minutes for an Email to make its way from the controller to its destination.
4	Change Ethernet Communications board.	Installation instructions provided with new board. ATTENTION The replacement Ethernet Communications board will have a label showing its MAC address. To avoid confusion, it is strongly recommended that you change the MAC address shown on the label on your instrument’s case to be the same as the MAC address shown on your new board.
5	Change Controller	

7.8 Restoring Factory Configuration

Introduction



This procedure restores the configuration of the instrument back to the Factory Settings per Section 3.31.

ATTENTION

Restoring the factory configuration overwrites all user-entered configuration changes. This procedure cannot be undone; it is a one-way process.

Table 7-16 explains how to restore Factory Configuration.

Table 7-16 Restoring Factory Configuration

Step	What to do
1	Turn off the power to the instrument for at least five seconds.
2	Turn the power back on and simultaneously press the Func-Loop 1/2 and  keys. This must be done while “TEST DONE” is being displayed.
3	If step 2 was performed correctly, the instrument will now display “UDC” [Upper] “UPDATE” [Lower].
4	Press the Func-Loop 1/2 Key. The instrument will now display “DIS” [Upper] “RESTORE” [Lower].
5	Press the  key. The instrument will now display “CONFIG” [Upper] “RESTORE” [Lower].
6	Press the Func-Loop 1/2 Key. The instrument will now display “DOING” [Upper] “RESTORE” [Lower].
7	When the instrument finishes the restore operation, it automatically resets itself and restarts in the product mode. The instrument configuration will now be the same as it was when the instrument left the factory and all user-entered configurations since that time have been overwritten.

7.9 Software Upgrades

Introduction

This procedure enables software features that were not ordered from the factory. See Table 8-3 for a list of the available Software Upgrades.



ATTENTION

This procedure cannot be undone; it is a one-way process.

Each instrument has a unique code number sequence, so the following procedure must be performed on each instrument to be upgraded.

Table 7-17 explains how to enable new software features.

Table 7-17 Software Upgrades

Step	What to do
1	Turn off the power to the instrument for at least five seconds.
2	Turn the power back on and simultaneously press the Func-Loop 1/2 and  keys. This must be done while “TEST DONE” is being displayed.
3	If step 2 was performed correctly, the instrument will now display “UDC” [Upper] “UPDATE” [Lower].
4	Press the Func-Loop 1/2 key. The instrument will now display DISABLE [Upper] “RESTORE” [Lower].
5	Press the  key. The instrument will now display “CONFIG” [Upper] “RESTORE” [Lower].
6	Press the  key. The instrument will now display OPTIONS [Upper] “RESTORE” [Lower].
7	Press the Func-Loop 1/2 key. The instrument will now display “XXXX” [Upper] “ENTER1” [Lower], where XXXX is a unique code number for this particular instrument. Write this number down.
8	Press the Func-Loop 1/2 key. The instrument will now display “XXXX” “ENTER2”. Write this number down.
9	Press the Func-Loop 1/2 key. The instrument will now display “XXXX” “ENTER3”. Write this number down.
10	Write down the Model and Serial Numbers of your instrument.

Step	What to do
11	<p>Contact your Honeywell Representative to place an order. Please have a company purchase order number available before you call. The order entry person will ask for the following information:</p> <ol style="list-style-type: none"> 1. Software Upgrade Part Number(s) you require per Table 8-3 2. Model Number of your instrument(s) 3. Serial Number of your instrument(s) 4. Code Numbers 1, 2 and 3 from your instrument(s) 5. Purchase order number. <p>With this information, a new code number set will be generated for your instrument(s).</p>
12	<p>When you have the new code number set provided by Honeywell, repeat steps 1 to 6.</p>
13	<p>Press the Func-Loop 1/2 key. The instrument will now display “XXXX” “ENTER1”, where XXXX is a unique code number for this particular instrument. Using the ▲ and ▼ keys, enter the new Code 1 number.</p>
14	<p>Press the Func-Loop 1/2 key. The instrument will now display “XXXX” “ENTER2”. Using the ▲ and ▼ keys, enter the new Code 2 number.</p>
15	<p>Press the Func-Loop 1/2 key. The instrument will now display “XXXX” “ENTER3”. Using the ▲ and ▼ keys, enter the new Code 3 number.</p>
16	<p>Press the Func-Loop 1/2 key. The instrument will process the new code numbers and add the new software feature. If the code numbers were entered incorrectly or if the wrong code numbers for this particular instrument were entered, then the controller will go into Manual Mode and flash the message “FAILSAFE” on the lower display. Check the code numbers being entered and repeat steps 12 through 16.</p>
17	<p>When the instrument finishes the operation, it automatically resets itself and restarts in the product mode. The instrument configuration now includes the added software feature(s).</p>

8 Parts List

8.1 Exploded View

Introduction

Figure 8-1 is an exploded view of the UDC3500 Controller. Each part is labeled with a key number. The part numbers are listed by key number in Table 8-1. Parts not shown are listed in Table 8-2.

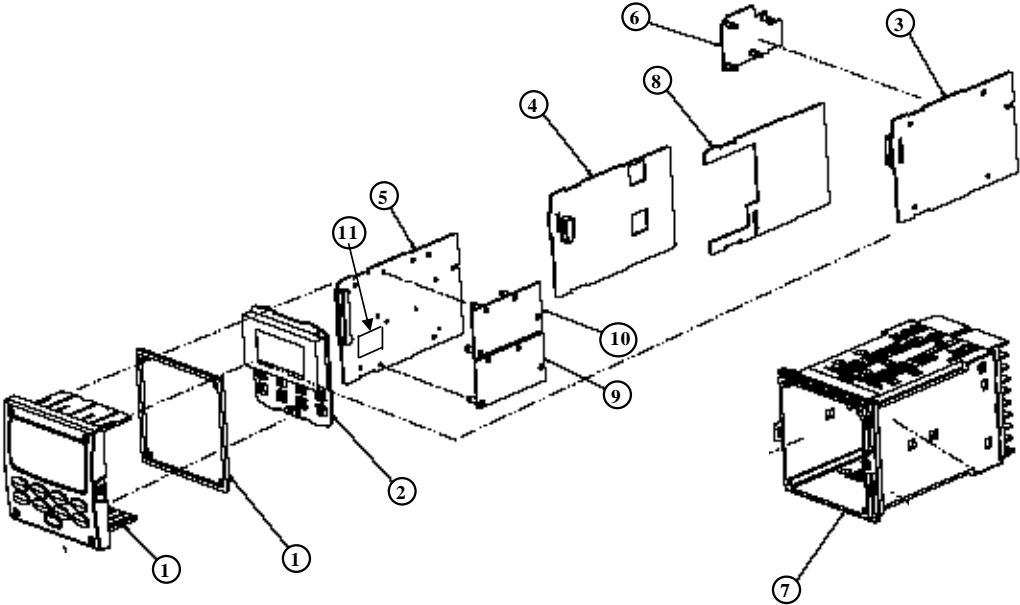

Figure 8-1 UDC3500 Exploded View

Table 8-1 Parts Identification

Key Number	Part Number	Description
1	51453143-503	Bezel Assembly and Bezel Gasket
2	51452845-501	Display/Keyboard PWA
3	51452831-501	Power/Output PWA (90-264 Vac Operation)
	50006376-501	Power/Output PWA (24 Vac/dc Operation)
4	51452837-502	Second Current Output/Digital Inputs/RS-422/485 Communications PWA
	51452840-501	Digital Inputs/Ethernet Communications PWA
5	51452828-502	MCU/Input PWA
6		Output 2
	30755306-501	• Electro-Mechanical Relay
	30756679-501	• Open Collector Output PWA
	30756725-501	• Solid State Relay
	51452807-501	• Dual Electromechanical Relay PWA
	51452834-501	• Third Current Output PWA
7	51452846-501	Case Assembly (including Mounting Kit with 4 brackets & screws)
8	51452843-501	Optional Relays PWA (Relays 3, 4 and 5)
9	51452825-501	Optional Input PWA (used for Inputs 2 and 4)
10	51452825-501	Optional Input PWA (used for Inputs 3 and 5)
11	51453140-501	Battery Module

Table 8-2 Parts Not Shown

Part Number	Description
30731996-506	Milliamp Input Resistor Assembly (250 ohm)
30754465-501	0-10 Volt or -1-1 Volt Input Resistor Assembly (100K pair)
51453364-501	Thermocouple Input Cold Junction Sensor Assembly
51452763-501	Mounting Kits (12 brackets & screws)
50010425-501	Ethernet Adapter Kit (RJ-45 Connector)
50004821-501	NEMA Panel Support Kit (for bracing thin mounting panels)

Table 8-3 Software Upgrades (see Section 7.9)

Part Number	Description
50004636-501	Math Options
50004636-502	Set Point Programming (SPP) – Single Program
50004636-503	Healthwatch
50004636-504	Two Loops / Cascade
50004636-505	Not Available (Future Enhancement)
50004636-506	Set Point Programming (SPP) – Four Programs

8.2 Removing the chassis

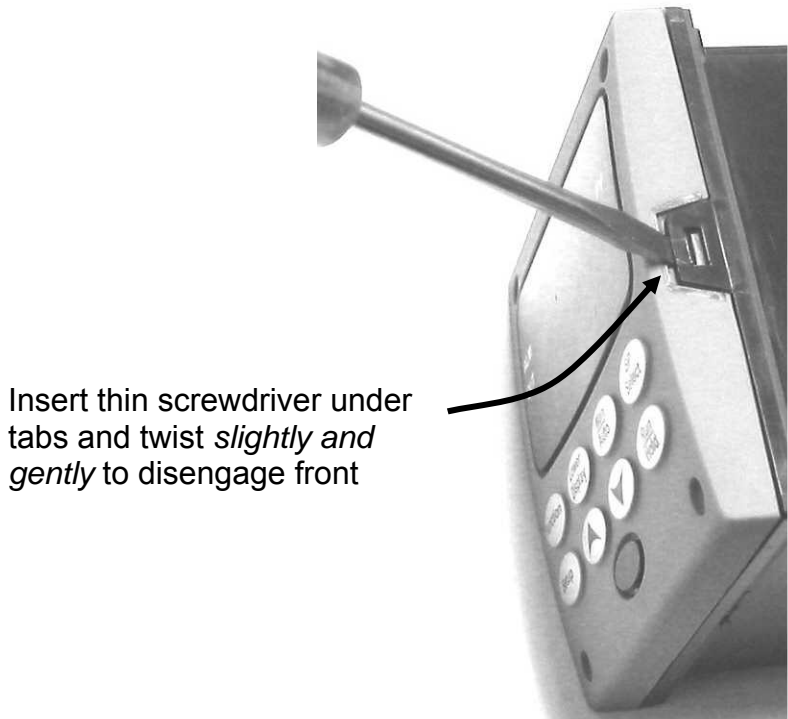

Using a thin screwdriver, *gently* twist the screwdriver to pry the side tabs from the front face. Pry just enough to release it, *otherwise you'll bend or break the tab*. If you break or bend the tab and can't reattach the front snugly, you'll need to reattach the front using the 4 NEMA4 screws provided. See Section 2.5 Mounting.

9 Modbus RTU Function Codes

9.1 Overview

This section describes the function codes needed to upload and download the configuration from a host computer into the instrument.

What's in this section?

The following topics are covered in this section.

TOPIC	See Page
9.1 Overview	338
9.2 General Information	338
9.3 Function Code 20	340
9.4 Function Code 21	344

9.2 General Information

This instrument uses a subset of the standard Modbus RTU function codes to provide access to process-related information. Several MODICON function codes are implemented. It is appropriate to define instrument-specific "user-defined" function codes. Where differences occur between the two protocols it will be noted. Several standard Modbus RTU function codes are supported.

Configuration ID Tags

Function codes **20** and **21** use the RS422/485 tag IDs for accessing configuration and process-related data. These tags are fully explained in *Section 10*.

The tag IDs represent the *register addresses* used in the Request Message.

Register Address Structure

Table 9-1 Integer Parameter Type

Register Numbers (Dec)	Name	Access	Notes
1	Type = 1	NOT SUPPORTED	16-bit Unsigned Integer
2	Attribute	NOT SUPPORTED	1 = Read Only, 2 = Read/Write
3	Value (16 bit integer)	Read / Write	
4	Not Used	NOT SUPPORTED	
5	Low Range (16 bit integer)	NOT SUPPORTED	
6	Not Used	NOT SUPPORTED	
7	High Range (16 bit Integer)	NOT SUPPORTED	
8	Not Used	NOT SUPPORTED	
9 to 13	Description Text (ASCII string)	NOT SUPPORTED	

Table 9-2 Floating Point Parameter Type

Register Numbers (Dec)	Name	Access	Notes
1	Type = 2	NOT SUPPORTED	IEEE Floating Point
2	Attribute	NOT SUPPORTED	1 = Read Only, 2 = Read/Write
3	Value (float high word)	Read / Write	
4	Value (float low word)	NOT SUPPORTED	
5	Low Range (float high word)	NOT SUPPORTED	
6	Low Range (float low word)	NOT SUPPORTED	
7	High Range (float high word)	NOT SUPPORTED	
8	High Range (float low word)	NOT SUPPORTED	
9 to 13	Description Text (ASCII string)	NOT SUPPORTED	

Register Count

The register count depends on the data format of the registers being read or written.

Integer data is represented in sixteen bits and is transferred high byte first.

Floating point data is transferred in IEEE 32-bit format.

The register count definitions are:

0001 = Integer Data

0002 = Floating Point Data

9.3 Function Code 20 (14h) - Read Configuration Reference Data

Description

Function code 20 (14 Hex) is used in this instrument to read information stored in its configuration database. Each configuration item is explicitly addressed by a file number and register address. IEEE 32-bit floating point and 16-bit integer formats are supported.

Request and Response Formats

The Request and Response formats for Function code 20 (14 Hex) are shown below. Details for each block reference follow.

Request Message Format

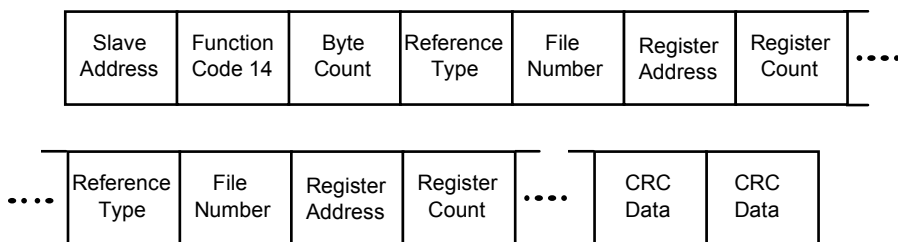

Response Message Format

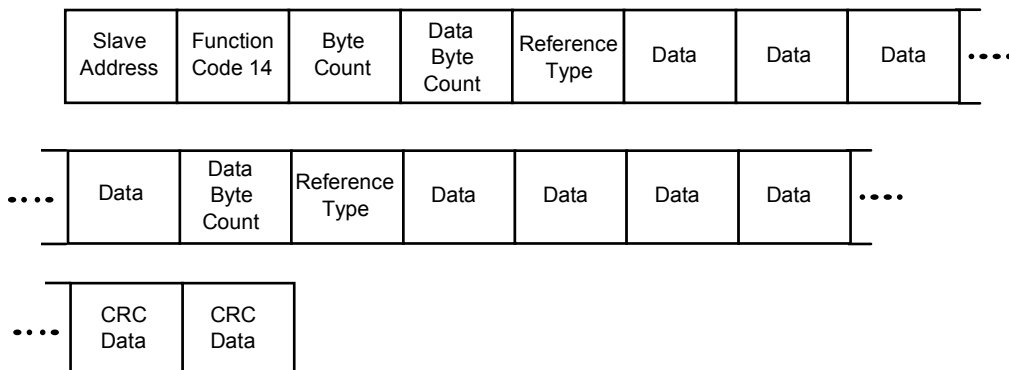

Byte Count

The Byte Count equals the number of bytes transmitted in either the request or response message and will be the minimum number required in order to transmit all requested data.

Data Byte Count

The Data Byte Count is the number of data bytes of the *sub response* including the Reference Type but not including itself. A floating point sub response has four bytes of data and one byte representing the reference type making the data byte count equal to five.

Reference Type Definitions

The Reference Type definition is always 06.
See examples in Subsection 9.3.1

File Number

The file number word contains the register number from the register address structure tables on page 339. Although the register address structure tables indicate up to 13 data registers are available for access, only register address 3 is currently supported.

Register Address

The register address word represents the tag ID number for the parameter(s) being accessed. The register address word is made up of two bytes. The LSB contains the tag ID number. The tag ID numbers represent the parameter's register address(es). See Section 10 for the tag ID numbers. The MSB contains the control loop and database extension using codes as shown below:

Modbus register address (High register, Low register)

- 00 h,xx - loop 1 basic data base registers
- 01 h,xx - loop 2 basic data base registers
- 40 h,xx - loop 1 extended data base registers
- 41 h,xx - loop 2 extended data base registers

xx = Modbus parameter ID register address in hex– Implied Format

Table 9-3 Register Parameter ID Address Format for Function Code 20

Register Address(es) (Decimal)	Register Address(es) (Hex)	Format
001 to 127	0001 to 007F	analog formatted data (2 registers – IEEE 32-bit floating point)
128 to 255	0080 to 00FF	integer formatted data (1 register – 16-bit integer)

9.3.1 Read Configuration Examples

Example #1

The following is an example of a request to read the Gain 1 value using Function code 20.

Request Message (Read (Gain 1) = ID Tag 001) 02 14 07 06 00 03 00 01 00 02 (CRC16)
--

Where:

02	=	Address
14	=	Function Code 20 (14 hex)
07	=	Byte Count
06	=	Reference Type
00,03	=	File Number (Access Data Value)
00,01	=	Register Address (Standard Access Gain 1 - Tag ID #1)
00 02	=	Register Count (Floating Point Data)
		(CRC16)

This is the response to the above request.

Response Message 02 14 06 05 06 3F C0 00 00 (CRC16)

Where:

02	=	Address
14	=	Function Code 20 (14 Hex)
06	=	Byte Count
05	=	Sub Message Length
06	=	Reference Type (IEEE Floating Point)
3F C0 00 00	=	1.50 (Value of Proportional Band)
		(CRC16)

Example #2

The following is another example of a request and response message using Function code 20.

Request Message (Read LSP #1 = ID Tag 39 and LSP #2 = ID Tag 53)

```
02 14 0E 06 00 03 00 27 00 02 06 00 03 00 35 00 02 (CRC16)
```

Where:

```
02      = Address
14      = Function Code 20 (14 Hex)
0E      = Byte Count
06      = Reference Type (IEEE Floating Point)
00,03   = File Number (Access Data Value)
00,27   = Register Address (Standard Access LSP #1 - ID Tag 39)
00,02   = Register Count to read (Floating Point Data)
06      = Reference Type (IEEE Floating Point)
00,03   = File Number (Access Data Value)
00,35   = Register Address (Standard Access LSP #2 - ID Tag 53)
00,02   = Register Count to read (Floating Point Data)
(CRC16)
```

This is the response to the above request.

Response Message

```
02 14 0C 05 06 43 C8 00 00 05 06 44 60 00 00 (CRC16)
```

Where:

```
02      = Address
14      = Function Code 20 (14 Hex)
0C      = Byte Count
05      = Data Byte Count (Sub Message Length)
06      = Reference Type (IEEE Floating Point)
43 C8 00 00 = 400.0 (Value of Local Setpoint #1)
05      = Data Byte Count (Sub Message Length)
06      = Reference Type (IEEE Floating Point)
44 60 00 00 = 896.0 (Value of Local Setpoint #2)
(CRC16)
```

9.4 Function Code 21 (15h) - Write Configuration Reference Data

Introduction

Function Code 21 (15 Hex) is used in this instrument to allow writes of integer and floating point values to the configuration database and override values.

The configuration database of this instrument is located in EEROM. The override values are stored in RAM.

Integer format is used to write to “Digital” configuration items. Floating Point format is used to write to “Analog” configuration items as defined by the configuration ID tags.

Write Restrictions

Care should be taken not to exceed the 100,000-write limit of the EEROM.

Request and Response Formats

The Request and Response formats for Function code 21 (15 Hex) are shown below. Details for each block reference follow.

Request Message Format

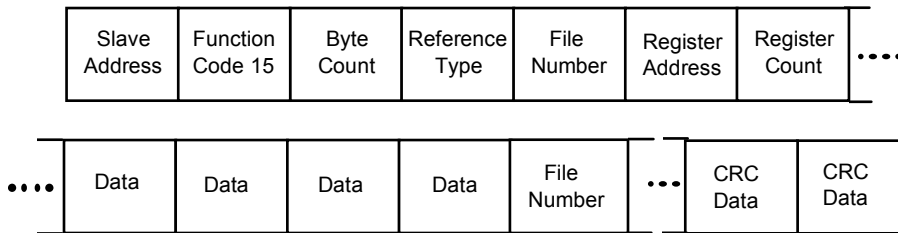

Response Message Format (echo back of request)

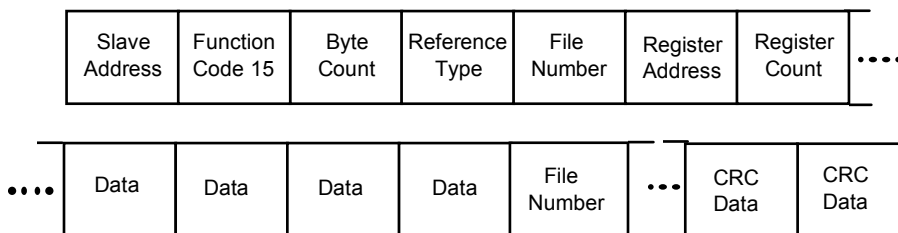

The register address is interpreted by this instrument as the tag ID configuration number.

For Infrared Transactions, add three BOFs (C0hex) at the beginning of each message and one EOF (Ffhex) at the end of each message.

Reference Type Definitions

The Reference Type definition is always 06.
See examples in Subsection 9.4.1

File Number

The file number word contains the register number from the register address structure shown in Table 9-1 and Table 9-2. Although the register address structure tables indicate up to 13 data registers are available for access, only register address 3 is currently supported.

Register Address

The register address is used to designate the tag ID number for the parameter being accessed. The register address is made up of two bytes. The LSB contains the RS422 tag ID number. The tag ID numbers represent the parameter's register address(es). See *Section 10* for the tag ID numbers. The MSB contains the control loop and database extension using codes as shown below:

Modbus register address (High register, Low register)

00 h,xx - loop 1 basic data base registers

01 h,xx - loop 2 basic data base registers

40 h,xx - loop 1 extended data base registers

41 h,xx - loop 2 extended data base registers

xx = Modbus Parameter ID register address in hex– Implied Format

Table 9-4 Register Parameter ID Address Format for Function Code 21

Register Address(es) (Dec)	Register Address(es) (Hex)	Format
001 to 127	0001 to 007F	analog formatted data (2 registers – IEEE 32-bit floating point)
128 to 255	0080 to 00FF	integer formatted data (2 registers – IEEE 32-bit floating point)

Unrestricted Registers

As mentioned previously, all register data is stored in the EEROM of this instrument with some exceptions. These exceptions were made to allow write access to override information. The registers, which are designated as Override values, are listed below. These registers do not have restrictions on the number of writes.

<i>ID Tag</i>	<i>Register Number</i>	<i>UDC Usage</i>
125	(7Dh)	Computer Setpoint

Restrictions on Parameter Numbers in One Message

The maximum number of writeable parameters per write request is 1.

9.4.1 Write Configuration Examples

Example #1

The following is an example of a request to write the Gain 1 value using Function code 21 (15 Hex).

Request Message (Write Gain 1= 1.5 “ID Tag 1”) 02 15 0B 06 00 03 00 01 00 02 3F C0 00 00 (CRC16)
--

Where:

02	=	Address
15	=	Function Code 21 (15 Hex)
0B	=	Byte Count
06	=	Reference Type (IEEE Floating Point)
00 03	=	File Number (Access Data Value)
00 01	=	Register Address (Standard Access - Gain 1 - ID Tag 1)
00 02	=	Register Count (Floating Point Data)
3F C0 00 00	=	1.50 (CRC16)

This is the response to the above request.

Response Message (The response is an echo of the request) 02 15 0B 06 00 01 00 02 00 02 3F C0 00 00 (CRC16)

10 Modbus Read, Write and Override Parameters plus Exception Codes

10.1 Overview

Introduction

This section contains information concerning Reading, Writing, and Overriding parameters in this instrument. There are two types of parameters:

- **Data Transfer**—These parameters include reading control data, option status, and reading or changing setpoints.
- **Configuration Data**—All the configuration data is listed in the order in which it appears in the controller.

Each type of parameter has the identifying codes listed with it.

What's in this section?

The following topics are covered in this section.

TOPIC	See Page
10.1 Overview	347
10.2 Reading Control Data	350
10.3 Read Options Status	351
10.4 Miscellaneous Read Onlys	352
10.5 Setpoints	353
10.6 Using a Computer Setpoint (Overriding Controller Setpoint)	355
10.7 Configuration Parameters	356
10.8 Modbus RTU Exception Codes	434

General Information

Non-volatile Memory Retention

- This controller uses non-volatile memory to store configuration data. These memories are guaranteed to retain data for a minimum of ten years as long as the data is not written and erased more than 10,000 times. In order not to exceed this number, it is strongly recommended that configurations that change rapidly such as Computer Setpoint use the Override feature, which does not affect non-volatile memory.

Analog Parameters

- Whenever analog register addresses xx01 through xx7F (those that can be changed via communications) are changed, a Write cycle occurs after receipt of the message and the response is returned.

Override Parameters

- Override analog register address xx7D (computer setpoint) is not stored in non-volatile memory. It can be changed as frequently as desired with no effect on non-volatile memory retentivity, but the controller must remain in the slave mode.

Digital Parameters

- Whenever digital configuration register addresses xx80 through xxFF are updated via communications, the non-volatile memory is updated as soon as the message is received.

Communications Transfer Rates

- The Host Computer must allow a minimum of 20 milliseconds between Read transactions and a minimum 200 milliseconds between Write transactions.

Supported Function Codes

- IR port 20 and 21
- RS485 and Ethernet ports 1,2,3,4,6,8,16,17,20,21

Communications Modes of Operation

- When the Shed Timer is enabled and a write or override occurs the controller will enter Slave Mode. The keypad is locked from the operator. The purpose of this mode is that if communications is lost and the shed timer times out then the controller will enter a known state of operation. The configuration of the “Shed Mode and Output” and Shed Setpoint Recall are used to configure the controller’s shed state. While in



Slave Mode pushing the  key enters Emergency Manual mode. The local operator then has control of the output. The controller is in Monitor Mode if the Shed timer is disabled.

EEROM Access

- All setpoints and configuration values are maintained in EEROM (Electrically Erasable Read Only Memory). To prevent unintended controller operation, the setpoint and configuration values stored in EEROM may only be altered by one source at a time, either via the Keyboard or via one of the Communications Ports (IR, RS-485 or Ethernet). Keyboard alterations take priority over all other communications methods. Therefore, whenever an operator initiates any change of value to a setpoint or to any other analog configuration value via the keyboard, the controller will then respond with a BUSY exception response to any MODBUS WRITE communications transaction initiated by the Host Computer until the operator completes accessing the EEROM. This only affects WRITE commands, READ commands will still be processed normally. Also, if the operator changes a setpoint value via the keyboard but does not save this

value into EEROM by pressing some key other than the Increment or Decrement keys, then there is an additional 15 second timeout delay after which time the changed value is automatically saved into EEROM. During this 15 second period, the controller will continue to respond with a BUSY exception message to any MODBUS WRITE communications transaction, as the controller is waiting for the operator to finish making changes to the setpoint via the keyboard. To minimize this busy period, the operator should always end a setpoint change by pressing any key other than the Increment or Decrement keys. This will reduce the time that the controller sends back busy exception messages to the host computer. MODBUS READ communication transactions are not affected, the controller will respond with a normal message to any READ command during the 15 second period.

10.2 Reading Control Data

Overview

The following control data can be read from this instrument:

- Input 1
- Input 2
- Input 3
- Input 4
- Input 5
- PV, SP, Output for each Loop

Register Addresses

Use the identifying codes listed in Table 10-1 to read the specific items.

A Write request for these codes will result in an Error message.

Table 10-1 Control Data Parameters

Parameter		Register Address		Data Type	Access	Data Range or Enumerated Selection
Description	ID	Hex	Decimal			
Input #1	123	007B	123	FP	RD	In Engineering Units or Percentage
Input #2	124	007C	124	FP	RD	In Engineering Units or Percentage
Input #3	126	007E	126	FP	RD	In Engineering Units or Percentage
Input #4	120	0078	120	FP	RD	In Engineering Units or Percentage
Input #5	121	0079	121	FP	RD	In Engineering Units or Percentage
PV, SP, Output Loop 1	122	007A	122	FP	RD	In Engineering Units
PV, SP, Output Loop 2	122	017A	378	FP	RD	In Engineering Units
PV Range Low Loop1	54	0036	054	FP	RD	-999.0 to +9999 in Engineering Units
PV Range High Loop1	55	0037	055	FP	RD	-999.0 to +9999 in Engineering Units
PV Range Low Loop2	54	0136	310	FP	RD	-999.0 to +9999 in Engineering Units
PV Range High Loop2	55	0137	311	FP	RD	-999.0 to +9999 in Engineering Units

10.3 Read Software Options Status

Read

Doing a Read of register address 00B9 listed in Table 10-2 will tell you which of the available options are enabled / installed or disabled / not installed.

Table 10-2 Option Status

Parameter		Register Address		Data Type	Access	Data Range or Enumerated Selection
Description	ID	Hex	Decimal			
Option Status (Read only)	185	00B9	185	INT	RD	See Figure 10-1.

The data field in the response message will be a decimal number from 0 to 255. Convert the decimal number to binary as shown in Figure 10-1.to determine which options are or are not active.

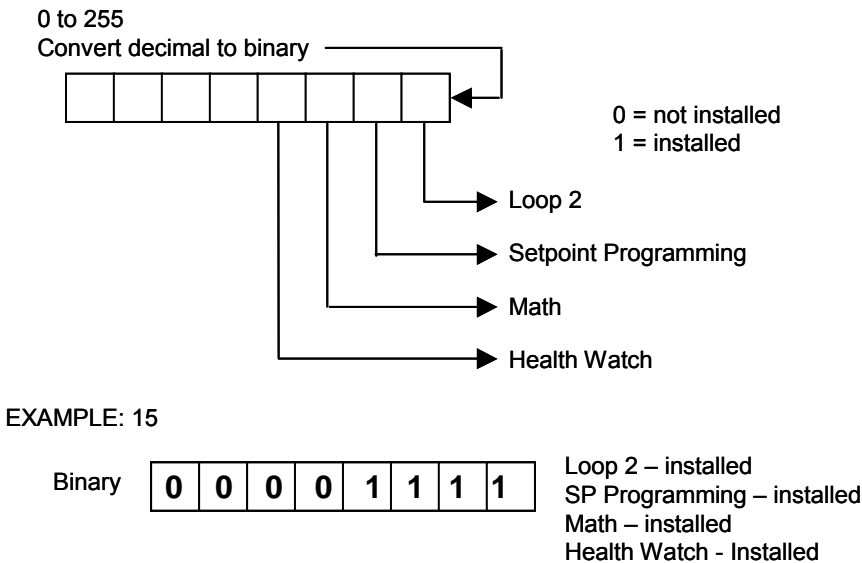

Figure 10-1 Software Option Status Information

10.4 Miscellaneous Read Onlys

10.4.1 Register Addresses for Read Onlys

The identifying register addresses listed in Table 10-3 represent some information that is Read only. No Writes allowed.

Table 10-3 Miscellaneous Read Onlys

Parameter		Register Address		Data Type	Access	Data Range or Enumerated Selection
Description	ID	Hex	Decimal			
Software Type	157	009D	157	INT	RD	READ only (UDC3500) 35 = UDC3500
Software Version	167	00A7	167	INT	RD	READ only Value less than 255

10.4.2 SetPoint Program Read Only Information

The identifying register addresses listed in Table 10-4 represent some information for SetPoint Programming that is Read only. No Writes allowed.

Table 10-4 SetPoint Program Read Only Information

Parameter		Register Address		Data Type	Access	Data Range or Enumerated Selection
Description	ID	Hex	Decimal			
Present SPP Segment Number	251	00FB	251	INT	RD	1 – 20
Segment Time Remaining in Minutes	252	00FC	252	INT	RD	0 – 59 Minutes
Segment Time Remaining in Hours	253	00FD	253	INT	RD	0 – 99 Hours
Cycles Remaining	254	00FE	254	INT	RD	0 – 100
Current Cycle Number	255	00FF	255	INT	RD	0 – 100

10.5 Setpoints

Overview

You can use four separate local setpoints in the controller. The identifying register addresses listed in Table 10-5 allow you to select which setpoint you want to use and to enter a value in Engineering Units or Percent (whichever is selected at register address 00A1) for that setpoint via communications.

Register Addresses

Make your selection using register address 00AD and enter the value for the setpoint chosen using register address in Table 10-5.

Table 10-5 Setpoint Code Selections

Parameter		Register Address		Data Type	Access	Data Range or Enumerated Selection
Description	ID	Hex	Decimal			
Local Setpoint #1 Loop1	39	0027	039	FP	R/W	Value within the setpoint range limits
Local Setpoint #2 Loop1	53	0035	053	FP	R/W	Value within the setpoint range limits
Local Setpoint #3 Loop1	116	0074	116	FP	R/W	Value within the setpoint range limits
Local Setpoint #4 Loop1	112	0070	112	FP	R/W	Value within the setpoint range limits
Number of Local Setpoints Loop 1	173	00AD	173	INT	R/W	00 = Local Setpoint #1 only 01 = 2nd Local Setpoint via keyboard or communications 03 = 3rd Local Setpoint via keyboard or communications 04 = four Local Setpoint via keyboard or communications
Local Setpoint #1 Loop2	39	0127	295	FP	R/W	Value within the setpoint range limits
Local Setpoint #2 Loop2	53	0135	309	FP	R/W	Value within the setpoint range limits
Local Setpoint #3 Loop2	116	0174	372	FP	R/W	Value within the setpoint range limits
Local Setpoint #4 Loop2	112	0170	368	FP	R/W	Value within the setpoint range limits

Parameter		Register Address		Data Type	Access	Data Range or Enumerated Selection
Description	ID	Hex	Decimal			
Number of Local Setpoints Loop 2	173	01AD	429	INT	R/W	00 = Local Setpoint #1 only 01 = 2nd Local Setpoint via keyboard or communications 03 = 3rd Local Setpoint via keyboard or communications 04 = four Local Setpoint via keyboard or communications

Associated Parameters

Refer to Table 10-6 to display or change any of the parameters associated with the setpoint.

Table 10-6 Setpoint Associated Parameters

Parameter		Register Address	
Description	ID	Hex	Decimal
Setpoint Limits Loop1	7,8	0007, 0008	007, 008
Setpoint Limits Loop 2	7,8	0107, 0108	263, 264

10.6 Using a Computer Setpoint (Overriding Controller Setpoint)

Overview

You can use a setpoint generated from the computer to override the setpoint being used by the controller. The value generated by the computer will have ratio and bias applied by the controller.

Register Addresses

Use the identifying code in Table 10-7 to enter the computer setpoint.

Table 10-7 Computer Setpoint Selection

Parameter		Register Address		Data Type	Access	Data Range or Enumerated Selection
Description	ID	Hex	Decimal			
Computer Setpoint Loop1	125	007D	125	FP	R/W	Value from computer with Ratio and Bias applied by the controller. Within the PV Range Limits in Engineering Units or Percent.
Computer Setpoint Loop2	125	017D	381	FP	R/W	Value from computer with Ratio and Bias applied by the controller. Within the PV Range Limits in Engineering Units or Percent.

Shed

The computer setpoint override will continue until SHED from communications occurs or the controller is placed into monitor mode through communications. Doing periodic SLAVE READS within the shed time will allow the override to continue until communication is stopped and shed time elapses. Does not apply to IR communications.

ATTENTION

0 Shed (code 79) allows the override to continue indefinitely or until the reset shed timer register address 1B90 and 1B91 is written using function code 6 or parameter ID 127 using function code 21. Any data value can be written because it is ignored.

When SP is overridden, the upper display becomes “C” momentarily, and the lower display shows the CSP value as CSP XXXX.

Table 10-7.1 Shed Timer Reset

Parameter		Register Address		Data Type	Access	Data Range or Enumerated Selection
Description	ID	Hex	Decimal			
Shed Timer Reset Loop1	127	007F	127	FP	W	Exit Slave Mode
Shed Timer Reset Loop2	127	017F	383	FP	W	Exit Slave Mode

Associated Parameters

Refer to Table 10-8 for the codes to display or change any of the parameters associated with the computer setpoint on loop 1.

Table 10-8 Computer Setpoint Associated Parameters for Loop 1

Parameter		Register Address	
Description	ID	Hex	Decimal
Setpoint Limits	7,8	0007, 0008	007, 008
Local Setpoint #1	39	0027	039
Local Setpoint #2	53	0035	053
Local Setpoint #3	116	0074	116
Local Setpoint #4	112	0070	112
Local Setpoint Selection	173	00AD	173
Computer Setpoint Ratio	90	005A	90
Computer Setpoint Bias	91	005B	91
Shed Timer Reset	127	007F	127

Refer to Table 10-9 for the codes to display or change any of the parameters associated with the computer setpoint on Loop 2.

Table 10-9 Computer Setpoint Associated Parameters for Loop2

Parameter		Register Address	
Description	ID	Hex	Decimal
Setpoint Limits	7,8	0107, 0108	263, 264
Local Setpoint #1	39	0127	295
Local Setpoint #2	53	0135	309
Local Setpoint #3	116	0174	372
Local Setpoint #4	112	0170	368
Local Setpoint Selection	173	01AD	429
Computer Setpoint Ratio	90	015A	346
Computer Setpoint Bias	91	015B	347
Shed Timer Reset	127	017F	383

10.7 Configuration Parameters

Overview

Listed on the next pages are the identifying codes for the parameters in the various Set-up Groups in this instrument. Most of the parameters are configurable through the hosts. Some are Read Only and are indicated as such and cannot be changed.

Reading or Writing

Do a Read or Write, depending on your requirements, using the identifying code and format code listed in the tables. The range or selection available for each range is listed in the tables.

10.7.1 Tuning Loop 1

Table 10-10 lists all the register addresses and ranges or selections for the function parameters in the Set-up Group – Tuning Loop 1.

Table 10-10 Set-up Group – Tuning Loop 1

Parameter		Register Address		Data Type	Access	Data Range or Enumerated Selection
Description	ID	Hex	Decimal			
Gain #1 or PB Note 1	1	0001	001	FP	R/W	0.001 to 1000 Gain 0.1 to 9999 PB
Rate #1 Note 1	2	0002	002	FP	R/W	0.00 to 10.00
Reset #1 Note 1	3	0003	003	FP	R/W	0.02 to 50.00
Manual Reset	13	000D	013	FP	R/W	-100 to +100
Gain #2 or PB #2 Note 1	4	0004	004	FP	R/W	0.001 to 1000 Gain 0.1 to 9999 PB
Rate #2 Note 1	5	0005	005	FP	R/W	0.00 to 10.00
Reset #2 Note 1	6	0006	006	FP	R/W	0.02 to 50.00
Gain #3 or PB #3 Note 1	1	4001	16385	FP	R/W	0.001 to 1000 Gain 0.1 to 9999 PB
Rate #3 Note 1	2	4002	16386	FP	R/W	0.00 to 10.00
Reset #3 Note 1	3	4003	16387	FP	R/W	0.02 to 50.00
Gain #4 or PB #4 Note 1	4	4004	16388	FP	R/W	0.001 to 1000 Gain 0.1 to 9999 PB

Parameter		Register Address		Data Type	Access	Data Range or Enumerated Selection
Description	ID	Hex	Decimal			
Rate #4 Note 1	5	4005	16389	FP	R/W	0.00 to 10.00
Reset #4 Note 1	6	4006	16390	FP	R/W	0.02 to 50.00
Cycle Time #1	21	0015	21	INT	R/W	1 to 120 seconds
Cycle Time #2	22	0016	22	INT	R/W	1 to 120 seconds
Lockout (keyboard only) Changes to data are always possible via communications regardless of this configuration.	132	0084	132	INT	R/W	0 =No Lockout 1 =Calibration Locked out 2 =+Configuration – Timer, Tuning, SP Ramp, Accutune are read/write 3 =+View – Tuning and SP Ramp are read/write, no other parameters are available 4 =Maximum Lockout
Security Code	80	0050	080	INT	R/W	0 to 9999
Man/Auto Key Lockout	191	00BF	191	INT	R/W	0 = Disabled 1 = Enabled
Run/Hold Key Lockout	238	00EE	238	INT	R/W	0 = Disabled 1 = Enabled
Setpoint Key Lockout	237	00ED	237	INT	R/W	0 = Disabled 1 = Enabled

NOTE 1: Writes to these locations are not available when Accutune is enabled.

10.7.2 Tuning Loop2

Table 10-11 lists all the register addresses and ranges or selections for the function parameters in the Set-up Group – Tuning Loop 2.

Table 10-11 Set-up Group – Tuning Loop 2

Parameter		Register Address		Data Type	Access	Data Range or Enumerated Selection
Description	ID	Hex	Decimal			
Gain #5 or PB Note 1	1	0101	257	FP	R/W	0.001 to 1000 Gain 0.1 to 9999 PB
Rate #5 Note 1	2	0102	258	FP	R/W	0.00 to 10.00
Reset #5 Note 1	3	0103	259	FP	R/W	0.02 to 50.00
Manual Reset	13	010D	269	FP	R/W	-100 to 100
Gain #6 or PB Note 1	4	0104	260	FP	R/W	0.001 to 1000 Gain 0.1 to 9999 PB
Rate #6 Note 1	5	0105	261	FP	R/W	0.00 to 10.00
Reset #6 Note 1	6	0106	262	FP	R/W	0.02 to 50.00
Gain #7 or PB Note 1	23	0117	279	FP	R/W	0.001 to 1000 Gain 0.1 to 9999 PB
Rate #7 Note 1	24	0118	280	FP	R/W	0.00 to 10.00
Reset #7 Note 1	25	0119	281	FP	R/W	0.02 to 50.00
Gain #8 or PB Note 1	26	011A	282	FP	R/W	0.001 to 1000 Gain 0.1 to 9999 PB
Rate #8 Note 1	27	011B	283	FP	R/W	0.00 to 10.00
Reset #8 Note 1	28	011C	284	FP	R/W	0.02 to 50.00
Cycle Time #5	21	0115	277	FP	R/W	1 to 120 seconds
Cycle Time #6	22	0116	278	FP	R/W	1 to 120 seconds

10.7.3 SP Ramp/Rate/Program #1

Table 10-12 lists all the register addresses and ranges or selections for the function parameters in Set-up Group Setpoint Ramp/Rate.

Table 10-12 Set-up Group – Setpoint Ramp/Rate/Program #1

Parameter		Register Address		Data Type	Access	Data Range or Enumerated Selection
Description	ID	Hex	Decimal			
SP Ramp	150	0196	406	INT	R/W	0 = Disabled 1 = Enable 1 2 = Enable 2 3 = Enable 12
Single SP Ramp Time	25	0019	25	FP	R/W	0 to 255 (minutes)
Final Ramp SP Value	26	001A	026	FP	R/W	PV Range in Engineering Units
SP Rate	174	01AE	430	INT	R/W	0 = Disabled 1 = Enable 1 2 = Enable 2 3 = Enable 12
Rate Up (EU/HR)	108	006C	108	FP	R/W	0 to 9999
Rate Down (EU/HR)	109	006D	109	FP	R/W	0 to 9999
Rate Up (EU/HR) Loop2	108	016C	364	FP	R/W	0 to 9999
Rate Down (EU/HR) Loop2	109	016D	365	FP	R/W	0 to 9999
Setpoint Program #1	178	01B2	434	INT	R/W	0 = Disabled 1 = Enable 1 2 = Enable 2 3 = Enable 12
Start Segment #	88	0058	88	FP	R/W	1 to 20
End Segment #(Soak)	176	00B0	176	INT	R/W	0 = Soak 2 1 = Soak 4 2 = Soak 6 3 = Soak 8 4 = Soak 10 5 = Soak 12 6 = Soak 14 7 = Soak 16 8 = Soak 18 9 = Soak 20
Engineering Units or Ramp Segments	182	00B6	182	INT	R/W	0 = HRS:MIN 1 = EU/Minute 2 = EU/Hour

Parameter		Register Address		Data Type	Access	Data Range or Enumerated Selection
Description	ID	Hex	Decimal			
Program Recycles	89	0059	89	FP	R/W	0 to 100
Controller Status at Program End	180	00B4	180	INT	R/W	0 = Last Setpoint and Mode 1 = Manual, Failsafe Output
Program End State	181	00B5	181	INT	R/W	0 = Disable SP Program 1 = Hold at Program End
Power UP	211	40D3	16595	INT	R/W	0 = Abort 1 = Resume 2 = Restart
Reset SP Program (ToBEGIN)	179	00B3	179	INT	R/W	0 = Disable 1 = Via Keypad 2 = Rerun
PV Hotstart	226	00E2	226	INT	R/W	0 = Disabled 1 = Enabled
Segment #1 Ramp Time	57	0039	057	FP	R/W	99.59 (0-99 Hrs:0-59 Min) or 0 to 999 (Degrees/Minute)
Segment #1 PID SET	191	40BF	16575	INT	R/W	0 = SET1 1 = SET2 2 = SET3 3 = SET4
Segment #2 Soak Setpoint Value	58	003A	058	FP	R/W	Within Setpoint Limits
Segment #2 Soak Time	59	003B	059	FP	R/W	99.59 (0-99 Hrs:0-59 Min)
Guaranteed Soak ##2	87	4057	16471	FP	R/W	0 to 99.9 (0 = no soak)
Segment #2 PID SET	192	40C0	16576	INT	R/W	0 = SET1 1 = SET2 2 = SET3 3 = SET4
Segment #3 Ramp Time	60	003C	060	FP	R/W	99.59 (0-99 Hrs:0-59 Min) or 0 to 999 (Degrees/Minute)
Segment #3 PID SET	193	40C1	16577	INT	R/W	0 = SET1 1 = SET2 2 = SET3 3 = SET4

Parameter		Register Address		Data Type	Access	Data Range or Enumerated Selection
Description	ID	Hex	Decimal			
Segment #4 Soak Setpoint Value	61	003D	061	FP	R/W	Within Setpoint Limits
Segment #4 Soak Time	62	003E	062	FP	R/W	99.59 (0-99 Hrs:0-59 Min)
Guaranteed Soak ##4	89	4058	16472	FP	R/W	0 to 99.9 (0 = no soak)
Segment #4 PID SET	194	40C2	16578	INT	R/W	0 = SET1 1 = SET2 2 = SET3 3 = SET4
Segment #5 Ramp Time	63	003F	063	FP	R/W	99.59 (0-99 Hrs:0-59 Min) or 0 to 999 (Degrees/Minute)
Segment #5 PID SET	195	40C3	16579	INT	R/W	0 = SET1 1 = SET2 2 = SET3 3 = SET4
Segment #6 Soak Setpoint Value	64	0040	064	FP	R/W	Within Setpoint Limits
Segment #6 Soak Time	65	0041	065	FP	R/W	99.59 (0-99 Hrs:0-59 Min)
Guaranteed Soak ##6	89	4059	16473	FP	R/W	0 to 99.9 (0 = no soak)
Segment #6 PID SET	196	40C4	16580	INT	R/W	0 = SET1 1 = SET2 2 = SET3 3 = SET4
Segment #7 Ramp Time	66	0042	066	FP	R/W	99.59 (0-99 Hrs:0-59 Min) or 0 to 999 (Degrees/Minute)
Segment #7 PID SET	197	40C5	16581	INT	R/W	0 = SET1 1 = SET2 2 = SET3 3 = SET4
Segment #8 Soak Setpoint Value	67	0043	067	FP	R/W	Within Setpoint Limits
Segment #8 Soak Time	68	0044	068	FP	R/W	99.59 (0-99 Hrs:0-59 Min)
Guaranteed Soak ##8	90	405A	16474	FP	R/W	0 to 99.9 (0 = no soak)

Parameter		Register Address		Data Type	Access	Data Range or Enumerated Selection
Description	ID	Hex	Decimal			
Segment #8 PID SET	198	40C6	16582	INT	R/W	0 = SET1 1 = SET2 2 = SET3 3 = SET4
Segment #9 Ramp Time		0045	069	FP	R/W	99.59 (0-99 Hrs:0-59 Min) or 0 to 999 (Degrees/Minute)
Segment #9 PID SET	199	40C7	16583	INT	R/W	0 = SET1 1 = SET2 2 = SET3 3 = SET4
Segment #10 Soak Setpoint Value	70	0046	070	FP	R/W	Within Setpoint Limits
Segment #10 Soak Time	71	0047	071	FP	R/W	99.59 (0-99 Hrs:0-59 Min)
Guaranteed Soak ##10	91	405B	16475	FP	R/W	0 to 99.9 (0 = no soak)
Segment #10 PID SET	200	40C8	16584	INT	R/W	0 = SET1 1 = SET2 2 = SET3 3 = SET4
Segment #11 Ramp Time	72	0048	072	FP	R/W	99.59 (0-99 Hrs:0-59 Min) or 0 to 999 (Degrees/Minute)
Segment #11 PID SET	201	40C9	16585	INT	R/W	0 = SET1 1 = SET2 2 = SET3 3 = SET4
Segment #12 Soak Setpoint Value	73	0049	073	FP	R/W	Within Setpoint Limits
Segment #12 Soak Time	74	004A	074	FP	R/W	99.59 (0-99 Hrs:0-59 Min)
Guaranteed Soak ##12	92	405C	16476	FP	R/W	0 to 99.9 (0 = no soak)
Segment #12 PID SET	202	40CA	16586	FP	R/W	0 = SET1 1 = SET2 2 = SET3 3 = SET4

Parameter		Register Address		Data Type	Access	Data Range or Enumerated Selection
Description	ID	Hex	Decimal			
Segment #13 Ramp Time	72	4048	16456	FP	R/W	99.59 (0-99 Hrs:0-59 Min) or 0 to 999 (Degrees/Minute)
Segment #13 PID SET	203	40CB	16587	INT	R/W	0 = SET1 1 = SET2 2 = SET3 3 = SET4
Segment #14 Soak Setpoint Value	73	4049	16457	FP	R/W	Within Setpoint Limits
Segment #14 Soak Time	74	404A	16458	FP	R/W	99.59 (0-99 Hrs:0-59 Min)
Guaranteed Soak ##14	93	405D	16477	FP	R/W	0 to 99.9 (0 = no soak)
Segment #14 PID SET	204	40CC	16588	INT	R/W	0 = SET1 1 = SET2 2 = SET3 3 = SET4
Segment #15 Ramp Time	75	404B	16459	FP	R/W	99.59 (0-99 Hrs:0-59 Min) or 0 to 999 (Degrees/Minute)
Segment #15 PID SET	205	40CD	16589	INT	R/W	0 = SET1 1 = SET2 2 = SET3 3 = SET4
Segment #16 Soak Setpoint Value	76	404C	16460	FP	R/W	Within Setpoint Limits
Segment #16 Soak Time	77	404D	16461	FP	R/W	99.59 (0-99 Hrs:0-59 Min)
Guaranteed Soak ##16	94	405E	16478	FP	R/W	0 to 99.9 (0 = no soak)
Segment #16 PID SET	206	40CE	16590	INT	R/W	0 = SET1 1 = SET2 2 = SET3 3 = SET4
Segment #17 Ramp Time	78	404E	16462	FP	R/W	99.59 (0-99 Hrs:0-59 Min) or 0 to 999 (Degrees/Minute)

Parameter		Register Address		Data Type	Access	Data Range or Enumerated Selection
Description	ID	Hex	Decimal			
Segment #17 PID SET	207	40CF	16591	INT	R/W	0 = SET1 1 = SET2 2 = SET3 3 = SET4
Segment #18 Soak Setpoint Value	79	404F	16463	FP	R/W	Within Setpoint Limits
Segment #18 Soak Time	80	4050	16464	FP	R/W	99.59 (0-99 Hrs:0-59 Min)
Guaranteed Soak ##18	95	505F	16479	FP	R/W	0 to 99.9 (0 = no soak)
Segment #18 PID SET	208	40D0	16592	INT	R/W	0 = SET1 1 = SET2 2 = SET3 3 = SET4
Segment #19 Ramp Time	81	4051	16465	FP	R/W	99.59 (0-99 Hrs:0-59 Min) or 0 to 999 (Degrees/Minute)
Segment #19 PID SET	209	40D1	16593	INT	R/W	0 = SET1 1 = SET2 2 = SET3 3 = SET4
Segment #20 Soak Setpoint Value	82	4052	16466	FP	R/W	Within Setpoint Limits
Segment #20 Soak Time	83	4053	16467	FP	R/W	99.59 (0-99 Hrs:0-59 Min)
Guaranteed Soak ##20	96	4060	16480	FP	R/W	0 to 99.9 (0 = no soak)
Segment #20 PID SET	210	40D2	16594	INT	R/W	0 = SET1 1 = SET2 2 = SET3 3 = SET4

10.7.4 Setpoint Program #2

Table 10-13 lists all the register addresses and ranges or selections for the function parameters in Set-up Group Setpoint Program #2.

Table 10-13 Set-up Group – Setpoint Program #2

Parameter		Register Address		Data Type	Access	Data Range or Enumerated Selection
Description	ID	Hex	Decimal			
Setpoint Program #2	128	6080	24704	INT	R/W	0 = Disabled 1 = Enable 1 2 = Enable 2 3 = Enable 12 4 = Link 1 and 2
Start Segment #	41	6029	24617	FP	R/W	1 to 20
End Segment #(Soak)	129	6081	24705	INT	R/W	0 = Soak 2 1 = Soak 4 2 = Soak 6 3 = Soak 8 4 = Soak 10 5 = Soak 12 6 = Soak 14 7 = Soak 16 8 = Soak 18 9 = Soak 20
Engineering Units or Ramp Segments	130	6082	24706	INT	R/W	0 = HRS:MIN 1 = EU/Minute 2 = EU/Hour
Program Recycles	42	602a	24618	FP	R/W	0 to 100
PV Hotstart	131	6083	24707	INT	R/W	0 = Disabled 1 = Enabled
Segment #1 Ramp Time	1	6001	24577	FP	R/W	99.59 (0-99 Hrs:0-59 Min) or 0 to 999 (Degrees/Minute)
Segment #1 PID SET	141	608D	24717	INT	R/W	0 = SET1 1 = SET2 2 = SET3 3 = SET4
Segment #2 Soak Setpoint Value	2	6002	24578	FP	R/W	Within Setpoint Limits
Segment #2 Soak Time	3	6003	24579	FP	R/W	99.59 (0-99 Hrs:0-59 Min)
Guaranteed Soak ##2	31	601F	24607	FP	R/W	0 to 99.9 (0 = no soak)

Parameter		Register Address		Data Type	Access	Data Range or Enumerated Selection
Description	ID	Hex	Decimal			
Segment #2 PID SET	142	608E	24718	INT	R/W	0 = SET1 1 = SET2 2 = SET3 3 = SET4
Segment #3 Ramp Time	4	6004	24580	FP	R/W	99.59 (0-99 Hrs:0-59 Min) or 0 to 999 (Degrees/Minute)
Segment #3 PID SET	143	608F	24719	INT	R/W	0 = SET1 1 = SET2 2 = SET3 3 = SET4
Segment #4 Soak Setpoint Value	5	6005	24581	FP	R/W	Within Setpoint Limits
Segment #4 Soak Time	6	6006	24582	FP	R/W	99.59 (0-99 Hrs:0-59 Min)
Guaranteed Soak ##4	32	6020	24608	FP	R/W	0 to 99.9 (0 = no soak)
Segment #4 PID SET	144	6090	24720	INT	R/W	0 = SET1 1 = SET2 2 = SET3 3 = SET4
Segment #5 Ramp Time	7	6007	24583	FP	R/W	99.59 (0-99 Hrs:0-59 Min) or 0 to 999 (Degrees/Minute)
Segment #5 PID SET	145	6091	24721	INT	R/W	0 = SET1 1 = SET2 2 = SET3 3 = SET4
Segment #6 Soak Setpoint Value	8	6008	24584	FP	R/W	Within Setpoint Limits
Segment #6 Soak Time	9	6009	24585	FP	R/W	99.59 (0-99 Hrs:0-59 Min)
Guaranteed Soak ##6	33	6021	24609	FP	R/W	0 to 99.9 (0 = no soak)
Segment #6 PID SET	146	6092	24722	INT	R/W	0 = SET1 1 = SET2 2 = SET3 3 = SET4

Parameter		Register Address		Data Type	Access	Data Range or Enumerated Selection
Description	ID	Hex	Decimal			
Segment #7 Ramp Time	10	600A	24586	FP	R/W	99.59 (0-99 Hrs:0-59 Min) or 0 to 999 (Degrees/Minute)
Segment #7 PID SET	147	6093	24723	INT	R/W	0 = SET1 1 = SET2 2 = SET3 3 = SET4
Segment #8 Soak Setpoint Value	11	600B	24587	FP	R/W	Within Setpoint Limits
Segment #8 Soak Time	12	600C	24588	FP	R/W	99.59 (0-99 Hrs:0-59 Min)
Guaranteed Soak ##8	34	6022	24610	FP	R/W	0 to 99.9 (0 = no soak)
Segment #8 PID SET	148	6094	24724	INT	R/W	0 = SET1 1 = SET2 2 = SET3 3 = SET4
Segment #9 Ramp Time	13	600D	24589	FP	R/W	99.59 (0-99 Hrs:0-59 Min) or 0 to 999 (Degrees/Minute)
Segment #9 PID SET	149	6095	24725	INT	R/W	0 = SET1 1 = SET2 2 = SET3 3 = SET4
Segment #10 Soak Setpoint Value	14	600E	24590	FP	R/W	Within Setpoint Limits
Segment #10 Soak Time	15	600F	24591	FP	R/W	99.59 (0-99 Hrs:0-59 Min)
Guaranteed Soak ##10	35	6023	24611	FP	R/W	0 to 99.9 (0 = no soak)
Segment #10 PID SET	150	6096	24726	INT	R/W	0 = SET1 1 = SET2 2 = SET3 3 = SET4
Segment #11 Ramp Time	16	6010	24592	FP	R/W	99.59 (0-99 Hrs:0-59 Min) or 0 to 999 (Degrees/Minute)

Parameter		Register Address		Data Type	Access	Data Range or Enumerated Selection
Description	ID	Hex	Decimal			
Segment #11 PID SET	151	6097	24727	INT	R/W	0 = SET1 1 = SET2 2 = SET3 3 = SET4
Segment #12 Soak Setpoint Value	17	6011	24593	FP	R/W	Within Setpoint Limits
Segment #12 Soak Time	18	6012	24594	FP	R/W	99.59 (0-99 Hrs:0-59 Min)
Guaranteed Soak ##12	36	6024	24612	FP	R/W	0 to 99.9 (0 = no soak)
Segment #12 PID SET	152	6098	24728	FP	R/W	0 = SET1 1 = SET2 2 = SET3 3 = SET4
Segment #13 Ramp Time	19	6013	24595	FP	R/W	99.59 (0-99 Hrs:0-59 Min) or 0 to 999 (Degrees/Minute)
Segment #13 PID SET	153	6099	24729	INT	R/W	0 = SET1 1 = SET2 2 = SET3 3 = SET4
Segment #14 Soak Setpoint Value	20	6014	24596	FP	R/W	Within Setpoint Limits
Segment #14 Soak Time	21	6015	24597	FP	R/W	99.59 (0-99 Hrs:0-59 Min)
Guaranteed Soak ##14	37	6025	24613	FP	R/W	0 to 99.9 (0 = no soak)
Segment #14 PID SET	154	609A	24730	INT	R/W	0 = SET1 1 = SET2 2 = SET3 3 = SET4
Segment #15 Ramp Time	22	6016	24598	FP	R/W	99.59 (0-99 Hrs:0-59 Min) or 0 to 999 (Degrees/Minute)
Segment #15 PID SET	155	609B	24731	INT	R/W	0 = SET1 1 = SET2 2 = SET3 3 = SET4

Parameter		Register Address		Data Type	Access	Data Range or Enumerated Selection
Description	ID	Hex	Decimal			
Segment #16 Soak Setpoint Value	23	6017	24599	FP	R/W	Within Setpoint Limits
Segment #16 Soak Time	24	6018	24600	FP	R/W	99.59 (0-99 Hrs:0-59 Min)
Guaranteed Soak ##16	38	6026	24614	FP	R/W	0 to 99.9 (0 = no soak)
Segment #16 PID SET	156	609C	24732	INT	R/W	0 = SET1 1 = SET2 2 = SET3 3 = SET4
Segment #17 Ramp Time	25	6019	24601	FP	R/W	99.59 (0-99 Hrs:0-59 Min) or 0 to 999 (Degrees/Minute)
Segment #17 PID SET	157	609D	24733	INT	R/W	0 = SET1 1 = SET2 2 = SET3 3 = SET4
Segment #18 Soak Setpoint Value	26	601A	24602	FP	R/W	Within Setpoint Limits
Segment #18 Soak Time	27	601B	24603	FP	R/W	99.59 (0-99 Hrs:0-59 Min)
Guaranteed Soak ##18	39	6027	24615	FP	R/W	0 to 99.9 (0 = no soak)
Segment #18 PID SET	158	609E	24734	INT	R/W	0 = SET1 1 = SET2 2 = SET3 3 = SET4
Segment #19 Ramp Time	28	601C	24604	FP	R/W	99.59 (0-99 Hrs:0-59 Min) or 0 to 999 (Degrees/Minute)
Segment #19 PID SET	159	609F	24735	INT	R/W	0 = SET1 1 = SET2 2 = SET3 3 = SET4
Segment #20 Soak Setpoint Value	29	601D	24605	FP	R/W	Within Setpoint Limits
Segment #20 Soak Time	30	601E	24606	FP	R/W	99.59 (0-99 Hrs:0-59 Min)

Parameter		Register Address		Data Type	Access	Data Range or Enumerated Selection
Description	ID	Hex	Decimal			
Guaranteed Soak ##20	40	6028	24616	FP	R/W	0 to 99.9 (0 = no soak)
Segment #20 PID SET	160	60A0	24736	INT	R/W	0 = SET1 1 = SET2 2 = SET3 3 = SET4

10.7.5 Setpoint Program #3

Table 10-14 lists all the register addresses and ranges or selections for the function parameters in Set-up Group Setpoint Program #3.

Table 10-14 Set-up Group – Setpoint Program #3

Parameter		Register Address		Data Type	Access	Data Range or Enumerated Selection
Description	ID	Hex	Decimal			
Setpoint Program #3	132	6084	24708	INT	R/W	0 = Disabled 1 = Enable 1 2 = Enable 2 3 = Enable 12
Start Segment #	83	6053	24659	FP	R/W	1 to 20
End Segment #(Soak)	133	6085	24709	INT	R/W	0 = Soak 2 1 = Soak 4 2 = Soak 6 3 = Soak 8 4 = Soak 10 5 = Soak 12 6 = Soak 14 7 = Soak 16 8 = Soak 18 9 = Soak 20
Engineering Units or Ramp Segments	134	6086	24710	INT	R/W	0 = HRS:MIN 1 = EU/Minute 2 = EU/Hour
Program Recycles	84	6054	24660	FP	R/W	0 to 100
PV Hotstart	135	6087	24711	INT	R/W	0 = Disabled 1 = Enabled
Segment #1 Ramp Time	43	602B	24619	FP	R/W	99.59 (0-99 Hrs:0-59 Min) or 0 to 999 (Degrees/Minute)
Segment #1 PID SET	161	60A1	24737	INT	R/W	0 = SET1 1 = SET2 2 = SET3 3 = SET4
Segment #2 Soak Setpoint Value	44	602C	24620	FP	R/W	Within Setpoint Limits
Segment #2 Soak Time	45	602D	24621	FP	R/W	99.59 (0-99 Hrs:0-59 Min)
Guaranteed Soak ##2	73	6049	24649	FP	R/W	0 to 99.9 (0 = no soak)

Parameter		Register Address		Data Type	Access	Data Range or Enumerated Selection
Description	ID	Hex	Decimal			
Segment #2 PID SET	162	60A2	24738	INT	R/W	0 = SET1 1 = SET2 2 = SET3 3 = SET4
Segment #3 Ramp Time	46	602E	24622	FP	R/W	99.59 (0-99 Hrs:0-59 Min) or 0 to 999 (Degrees/Minute)
Segment #3 PID SET	163	60A3	24739	INT	R/W	0 = SET1 1 = SET2 2 = SET3 3 = SET4
Segment #4 Soak Setpoint Value	47	602F	24623	FP	R/W	Within Setpoint Limits
Segment #4 Soak Time	48	6030	24624	FP	R/W	99.59 (0-99 Hrs:0-59 Min)
Guaranteed Soak ##4	74	604A	24650	FP	R/W	0 to 99.9 (0 = no soak)
Segment #4 PID SET	164	60A4	24740	INT	R/W	0 = SET1 1 = SET2 2 = SET3 3 = SET4
Segment #5 Ramp Time	49	6031	24625	FP	R/W	99.59 (0-99 Hrs:0-59 Min) or 0 to 999 (Degrees/Minute)
Segment #5 PID SET	165	60A5	24741	INT	R/W	0 = SET1 1 = SET2 2 = SET3 3 = SET4
Segment #6 Soak Setpoint Value	50	6032	24626	FP	R/W	Within Setpoint Limits
Segment #6 Soak Time	51	6033	24627	FP	R/W	99.59 (0-99 Hrs:0-59 Min)
Guaranteed Soak ##6	67	6043	24643	FP	R/W	0 to 99.9 (0 = no soak)
Segment #6 PID SET	166	60A6	24742	INT	R/W	0 = SET1 1 = SET2 2 = SET3 3 = SET4

Parameter		Register Address		Data Type	Access	Data Range or Enumerated Selection
Description	ID	Hex	Decimal			
Segment #7 Ramp Time	52	6034	24628	FP	R/W	99.59 (0-99 Hrs:0-59 Min) or 0 to 999 (Degrees/Minute)
Segment #7 PID SET	167	60A7	24743	INT	R/W	0 = SET1 1 = SET2 2 = SET3 3 = SET4
Segment #8 Soak Setpoint Value	53	6035	24629	FP	R/W	Within Setpoint Limits
Segment #8 Soak Time	54	6036	24630	FP	R/W	99.59 (0-99 Hrs:0-59 Min)
Guaranteed Soak ##8	76	604C	24652	FP	R/W	0 to 99.9 (0 = no soak)
Segment #8 PID SET	168	60A8	24744	INT	R/W	0 = SET1 1 = SET2 2 = SET3 3 = SET4
Segment #9 Ramp Time	55	6037	24631	FP	R/W	99.59 (0-99 Hrs:0-59 Min) or 0 to 999 (Degrees/Minute)
Segment #9 PID SET	169	60A9	24745	INT	R/W	0 = SET1 1 = SET2 2 = SET3 3 = SET4
Segment #10 Soak Setpoint Value	56	6038	24632	FP	R/W	Within Setpoint Limits
Segment #10 Soak Time	57	6039	24633	FP	R/W	99.59 (0-99 Hrs:0-59 Min)
Guaranteed Soak #10	64	6040	24640	FP	R/W	0 to 99.9 (0 = no soak)
Segment #10 PID SET	170	60AA	24746	INT	R/W	0 = SET1 1 = SET2 2 = SET3 3 = SET4
Segment #11 Ramp Time	58	603A	24634	FP	R/W	99.59 (0-99 Hrs:0-59 Min) or 0 to 999 (Degrees/Minute)

Parameter		Register Address		Data Type	Access	Data Range or Enumerated Selection
Description	ID	Hex	Decimal			
Segment #11 PID SET	171	60AB	24747	INT	R/W	0 = SET1 1 = SET2 2 = SET3 3 = SET4
Segment #12 Soak Setpoint Value	59	603B	24635	FP	R/W	Within Setpoint Limits
Segment #12 Soak Time	60	603C	24636	FP	R/W	99.59 (0-99 Hrs:0-59 Min)
Guaranteed Soak #12	78	604E	24654	FP	R/W	0 to 99.9 (0 = no soak)
Segment #12 PID SET	172	60AC	24748	FP	R/W	0 = SET1 1 = SET2 2 = SET3 3 = SET4
Segment #13 Ramp Time	61	603D	24637	FP	R/W	99.59 (0-99 Hrs:0-59 Min) or 0 to 999 (Degrees/Minute)
Segment #13 PID SET	173	60AD	24749	INT	R/W	0 = SET1 1 = SET2 2 = SET3 3 = SET4
Segment #14 Soak Setpoint Value	62	603E	24638	FP	R/W	Within Setpoint Limits
Segment #14 Soak Time	63	603F	24639	FP	R/W	99.59 (0-99 Hrs:0-59 Min)
Guaranteed Soak #14	79	604F	24655	FP	R/W	0 to 99.9 (0 = no soak)
Segment #14 PID SET	174	60AE	24750	INT	R/W	0 = SET1 1 = SET2 2 = SET3 3 = SET4
Segment #15 Ramp Time	64	6040	24640	FP	R/W	99.59 (0-99 Hrs:0-59 Min) or 0 to 999 (Degrees/Minute)
Segment #15 PID SET	175	60AF	24751	INT	R/W	0 = SET1 1 = SET2 2 = SET3 3 = SET4

Parameter		Register Address		Data Type	Access	Data Range or Enumerated Selection
Description	ID	Hex	Decimal			
Segment #16 Soak Setpoint Value	65	6041	24641	FP	R/W	Within Setpoint Limits
Segment #16 Soak Time	66	6042	24642	FP	R/W	99.59 (0-99 Hrs:0-59 Min)
Guaranteed Soak #16	80	6050	24656	FP	R/W	0 to 99.9 (0 = no soak)
Segment #16 PID SET	176	60B0	24752	INT	R/W	0 = SET1 1 = SET2 2 = SET3 3 = SET4
Segment #17 Ramp Time	67	6043	24643	FP	R/W	99.59 (0-99 Hrs:0-59 Min) or 0 to 999 (Degrees/Minute)
Segment #17 PID SET	177	60B1	24753	INT	R/W	0 = SET1 1 = SET2 2 = SET3 3 = SET4
Segment #18 Soak Setpoint Value	68	6044	24644	FP	R/W	Within Setpoint Limits
Segment #18 Soak Time	69	6045	24645	FP	R/W	99.59 (0-99 Hrs:0-59 Min)
Guaranteed Soak #18	81	6051	24657	FP	R/W	0 to 99.9 (0 = no soak)
Segment #18 PID SET	178	60B2	24754	INT	R/W	0 = SET1 1 = SET2 2 = SET3 3 = SET4
Segment #19 Ramp Time	70	6046	24646	FP	R/W	99.59 (0-99 Hrs:0-59 Min) or 0 to 999 (Degrees/Minute)
Segment #19 PID SET	179	60B3	24755	INT	R/W	0 = SET1 1 = SET2 2 = SET3 3 = SET4
Segment #20 Soak Setpoint Value	71	6047	24647	FP	R/W	Within Setpoint Limits
Segment #20 Soak Time	72	6048	24648	FP	R/W	99.59 (0-99 Hrs:0-59 Min)

Parameter		Register Address		Data Type	Access	Data Range or Enumerated Selection
Description	ID	Hex	Decimal			
Guaranteed Soak #20	82	6052	24658	FP	R/W	0 to 99.9 (0 = no soak)
Segment #20 PID SET	180	60B4	24756	INT	R/W	0 = SET1 1 = SET2 2 = SET3 3 = SET4

10.7.6 Setpoint Program #4

Table 10-15 lists all the register addresses and ranges or selections for the function parameters in Set-up Group Setpoint Program #4.

Table 10-15 Set-up Group – Setpoint Program #4

Parameter		Register Address		Data Type	Access	Data Range or Enumerated Selection
Description	ID	Hex	Decimal			
Setpoint Program #4	136	6088	24712	INT	R/W	0 = Disabled 1 = Enable 1 2 = Enable 2 3 = Enable 12 4 = Link 3 and 4
Start Segment #	125	607D	24701	FP	R/W	1 to 20
End Segment #(Soak)	137	6089	24713	INT	R/W	0 = Soak 2 1 = Soak 4 2 = Soak 6 3 = Soak 8 4 = Soak 10 5 = Soak 12 6 = Soak 14 7 = Soak 16 8 = Soak 18 9 = Soak 20
Engineering Units or Ramp Segments	138	608A	24714	INT	R/W	0 = HRS:MIN 1 = EU/Minute 2 = EU/Hour
Program Recycles	126	607E	24702	FP	R/W	0 to 100
PV Hotstart	139	608B	24715	INT	R/W	0 = Disabled 1 = Enabled
Segment #1 Ramp Time	85	6055	24661	FP	R/W	99.59 (0-99 Hrs:0-59 Min) or 0 to 999 (Degrees/Minute)
Segment #1 PID SET	181	60B5	24757	INT	R/W	0 = SET1 1 = SET2 2 = SET3 3 = SET4
Segment #2 Soak Setpoint Value	86	6056	24662	FP	R/W	Within Setpoint Limits
Segment #2 Soak Time	87	6057	24663	FP	R/W	99.59 (0-99 Hrs:0-59 Min)
Guaranteed Soak #2	115	6073	24691	FP	R/W	0 to 99.9 (0 = no soak)

Parameter		Register Address		Data Type	Access	Data Range or Enumerated Selection
Description	ID	Hex	Decimal			
Segment #2 PID SET	182	60B6	24758	INT	R/W	0 = SET1 1 = SET2 2 = SET3 3 = SET4
Segment #3 Ramp Time	88	6058	24664	FP	R/W	99.59 (0-99 Hrs:0-59 Min) or 0 to 999 (Degrees/Minute)
Segment #3 PID SET	183	60B7	24759	INT	R/W	0 = SET1 1 = SET2 2 = SET3 3 = SET4
Segment #4 Soak Setpoint Value	89	6059	24665	FP	R/W	Within Setpoint Limits
Segment #4 Soak Time	90	605A	24666	FP	R/W	99.59 (0-99 Hrs:0-59 Min)
Guaranteed Soak #4	116	6074	24692	FP	R/W	0 to 99.9 (0 = no soak)
Segment #4 PID SET	184	60B8	24760	INT	R/W	0 = SET1 1 = SET2 2 = SET3 3 = SET4
Segment #5 Ramp Time	91	605B	24667	FP	R/W	99.59 (0-99 Hrs:0-59 Min) or 0 to 999 (Degrees/Minute)
Segment #5 PID SET	185	60B9	24761	INT	R/W	0 = SET1 1 = SET2 2 = SET3 3 = SET4
Segment #6 Soak Setpoint Value	92	605C	24668	FP	R/W	Within Setpoint Limits
Segment #6 Soak Time	93	605D	24669	FP	R/W	99.59 (0-99 Hrs:0-59 Min)
Guaranteed Soak #6	117	6075	24693	FP	R/W	0 to 99.9 (0 = no soak)
Segment #6 PID SET	186	60BA	24762	INT	R/W	0 = SET1 1 = SET2 2 = SET3 3 = SET4

Parameter		Register Address		Data Type	Access	Data Range or Enumerated Selection
Description	ID	Hex	Decimal			
Segment #7 Ramp Time	94	605E	24670	FP	R/W	99.59 (0-99 Hrs:0-59 Min) or 0 to 999 (Degrees/Minute)
Segment #7 PID SET	187	60BB	24763	INT	R/W	0 = SET1 1 = SET2 2 = SET3 3 = SET4
Segment #8 Soak Setpoint Value	95	605F	24671	FP	R/W	Within Setpoint Limits
Segment #8 Soak Time	96	6060	24672	FP	R/W	99.59 (0-99 Hrs:0-59 Min)
Guaranteed Soak #8	118	6076	24694	FP	R/W	0 to 99.9 (0 = no soak)
Segment #8 PID SET	188	60BC	24764	INT	R/W	0 = SET1 1 = SET2 2 = SET3 3 = SET4
Segment #9 Ramp Time	97	6061	24673	FP	R/W	99.59 (0-99 Hrs:0-59 Min) or 0 to 999 (Degrees/Minute)
Segment #9 PID SET	189	60BD	24765	INT	R/W	0 = SET1 1 = SET2 2 = SET3 3 = SET4
Segment #10 Soak Setpoint Value	98	6062	24674	FP	R/W	Within Setpoint Limits
Segment #10 Soak Time	99	6063	24675	FP	R/W	99.59 (0-99 Hrs:0-59 Min)
Guaranteed Soak #10	119	6077	24695	FP	R/W	0 to 99.9 (0 = no soak)
Segment #10 PID SET	190	60BE	24766	INT	R/W	0 = SET1 1 = SET2 2 = SET3 3 = SET4
Segment #11 Ramp Time	100	6064	24676	FP	R/W	99.59 (0-99 Hrs:0-59 Min) or 0 to 999 (Degrees/Minute)

Parameter		Register Address		Data Type	Access	Data Range or Enumerated Selection
Description	ID	Hex	Decimal			
Segment #11 PID SET	191	60BF	24767	INT	R/W	0 = SET1 1 = SET2 2 = SET3 3 = SET4
Segment #12 Soak Setpoint Value	101	6065	24677	FP	R/W	Within Setpoint Limits
Segment #12 Soak Time	102	6066	24678	FP	R/W	99.59 (0-99 Hrs:0-59 Min)
Guaranteed Soak #12	120	6078	24696	FP	R/W	0 to 99.9 (0 = no soak)
Segment #12 PID SET	192	60C0	24768	FP	R/W	0 = SET1 1 = SET2 2 = SET3 3 = SET4
Segment #13 Ramp Time	103	6067	24679	FP	R/W	99.59 (0-99 Hrs:0-59 Min) or 0 to 999 (Degrees/Minute)
Segment #13 PID SET	193	60C1	24769	INT	R/W	0 = SET1 1 = SET2 2 = SET3 3 = SET4
Segment #14 Soak Setpoint Value	104	6068	24680	FP	R/W	Within Setpoint Limits
Segment #14 Soak Time	105	6069	24681	FP	R/W	99.59 (0-99 Hrs:0-59 Min)
Guaranteed Soak #14	121	6079	24697	FP	R/W	0 to 99.9 (0 = no soak)
Segment #14 PID SET	194	60C2	24770	INT	R/W	0 = SET1 1 = SET2 2 = SET3 3 = SET4
Segment #15 Ramp Time	106	606A	24682	FP	R/W	99.59 (0-99 Hrs:0-59 Min) or 0 to 999 (Degrees/Minute)
Segment #15 PID SET	195	60C3	24771	INT	R/W	0 = SET1 1 = SET2 2 = SET3 3 = SET4

Parameter		Register Address		Data Type	Access	Data Range or Enumerated Selection
Description	ID	Hex	Decimal			
Segment #16 Soak Setpoint Value	107	606B	24683	FP	R/W	Within Setpoint Limits
Segment #16 Soak Time	108	606C	24684	FP	R/W	99.59 (0-99 Hrs:0-59 Min)
Guaranteed Soak #16	122	607A	24698	FP	R/W	0 to 99.9 (0 = no soak)
Segment #16 PID SET	196	60C4	24772	INT	R/W	0 = SET1 1 = SET2 2 = SET3 3 = SET4
Segment #17 Ramp Time	109	606D	24685	FP	R/W	99.59 (0-99 Hrs:0-59 Min) or 0 to 999 (Degrees/Minute)
Segment #17 PID SET	197	60C5	24773	INT	R/W	0 = SET1 1 = SET2 2 = SET3 3 = SET4
Segment #18 Soak Setpoint Value	110	606E	24686	FP	R/W	Within Setpoint Limits
Segment #18 Soak Time	111	606F	24687	FP	R/W	99.59 (0-99 Hrs:0-59 Min)
Guaranteed Soak #18	123	607B	24699	FP	R/W	0 to 99.9 (0 = no soak)
Segment #18 PID SET	198	60C6	24774	INT	R/W	0 = SET1 1 = SET2 2 = SET3 3 = SET4
Segment #19 Ramp Time	112	6070	24688	FP	R/W	99.59 (0-99 Hrs:0-59 Min) or 0 to 999 (Degrees/Minute)
Segment #19 PID SET	199	60C7	24775	INT	R/W	0 = SET1 1 = SET2 2 = SET3 3 = SET4
Segment #20 Soak Setpoint Value	113	6071	24689	FP	R/W	Within Setpoint Limits
Segment #20 Soak Time	114	6072	24690	FP	R/W	99.59 (0-99 Hrs:0-59 Min)

Parameter		Register Address		Data Type	Access	Data Range or Enumerated Selection
Description	ID	Hex	Decimal			
Guaranteed Soak #20	124	607C	24700	FP	R/W	0 to 99.9 (0 = no soak)
Segment #20 PID SET	200	60C8	24776	INT	R/W	0 = SET1 1 = SET2 2 = SET3 3 = SET4

10.7.7 Accutune

Table 10-16 lists all the register addresses and ranges or selections for the function parameters in Set-up Group Adaptive Tune.

Table 10-16 Set-up Group – Adaptive Tune

Parameter		Register Address		Data Type	Access	Data Range or Enumerated Selection
Description	ID	Hex	Decimal			
Fuzzy Overshoot Suppression	193	00C1	193	INT	R/W	0 = Disabled 1 = Enabled
Fuzzy Overshoot Suppression Loop2	193	01C1	449	INT	R/W	0 = Disabled 1 = Enable 1 2 = Enable 2 3 = Enable 12
Accutune Enable Loop 1	152	0098	152	INT	R/W	0 = Accutune Disabled 1 = Limit Tune 2 = SP Tune 3 = Tune + SP 4 = SP Tune + PV
Accutune Enable Loop2	152	0198	408	Int	R/W	0 = Accutune Disabled 1 = Limit Tune 2 = SP Tune 3 = Tune + SP 4 = SP Tune + PV
Accutune Duplex selection	225	00E1	225	INT	R/W	0 = Manual 1 = Auto 2 = Disable (blend)
Accutune Error (Read only) Loop1	151	0097	151	INT	R/W	0 = None 1 = Output Limits Insufficient 2 = PV Change 3 = Process Identification Failed 4 = Accutune Aborted 5 = Running 6 = Setpoint Error
Accutune Error (Read only) Loop2	151	0197	407	INT	R/W	0 = None 1 = Output > or < Output Limits or Man Step=0 2 = PV Change Insufficient 3 = Process Identification Failed 4 = Accutune Aborted 5 = Running 6 = Setpoint Error
Tune Criteria	139	008B	139	INT	R/W	0 = Normal 1 = Fast

Parameter		Register Address		Data Type	Access	Data Range or Enumerated Selection
Description	ID	Hex	Decimal			
Tune Criteria Loop2	139	018B	395	INT	R/W	0 = Normal 1 = Fast
ADT 1 Range Setpoint Change	102	0066	102	FP	R/W	5 – 15%
ADT 2 Range Setpoint Change	102	0166	358	FP	R/W	5 – 15%
KPG1 (Process Gain)	103	0067	103	FP	R/W	0.10 to10.00
KPG2(Process Gain)	103	0167	359	FP	R/W	0.10 to10.00

10.7.8 Algorithm

Table 10-17 lists all the register addresses and ranges or selections for the function parameters in Set-up Group Algorithm.

Table 10-17 Set-up Group – Algorithm

Parameter		Register Address		Data Type	Access	Data Range or Enumerated Selection
Description	ID	Hex	Decimal			
Control Algorithm Selection (Selection here will affect ID code 160 in Output Algorithms.)	128	0080	128	INT	R/W	0 = ON/OFF 1 = PID-A 2 = PID-B 3 = PD-A with Manual Reset 4 = Three Position Step 5 = Disable
Control Algorithm Selection Loop2	128	0180	384	INT	R/W	0 = unused 1 = PID-A 2 = PID-B 3 = PD with Manual Reset
PID Loops	168	01A8	424	INT	R/W	0 = Loop 1 Only 1 = Loop 2 Enabled 2 = Loop 1 & 2 are cascaded with Loop 2 as primary (No Output) Loop 1 is secondary
Output Override	136	0188	392	INT	R/W	0 = Disabled 1 = Hi Select 2 = Lo Select
Timer	216	00D8	216	INT	R/W	0 = Disable 1 = Enable
Period	99	0063	099	FP	R/W	00.00 TO 99.59
Start (Initiation)	217	00D9	217	INT	R/W	0 = Key (Run/Hold Key) 1 = Alarm 2
Time Display (Selection)	218	00DA	218	INT	R/W	0 = Time Remaining 1 = Elapsed Time
Timer Reset	214	00D6	214	INT	R/W	0 = Key (Run/Hold Key) 1 = AL1 (Alarm 1 or Key)
Timer Increment	215	00D7	215	INT	R/W	0 = Minutes (Counts hr/minute) 1 = Sec (Counts min/sec)

Parameter		Register Address		Data Type	Access	Data Range or Enumerated Selection
Description	ID	Hex	Decimal			
Input Algorithm 1 † Input source selected via ID 205, 206, 207.	204	00CC	204	INT	R/W	0 = None 1 = Weighted Average (LSP) † 2 = Feedforward – Summer † 3 = Feedforward – Multiplier † 4 = Relative Humidity 5 = Summer (with ratio and bias) † 6 = Input High Select (with ratio and bias) † 7 = Input low Select (with ratio and bias) † 8 = General Math A (sq. rt., mult., div.) † 9 = General Math B (sq. rt., mult.) † 10 = General Math C (mult., div.) † 11 = General Math D (mult.) † 12 = Carbon A 13 = Carbon B 14 = Carbon C 15 = Carbon D 16 = Carbon FCC 17 = Dewpoint 18 = Oxygen
Constant K	45	002D	045	FP	R/W	0.001 to 1000
Calc High	31	001F	031	FP	R/W	–999.0 to +9999 in Engineering Units
Calc Low	32	0020	032	FP	R/W	–999.0 to +9999 in Engineering Units
PV Range Low	54	0036	054	FP	RD	–999.0 to +9999 in Engineering Units
PV Range High	55	0037	055	FP	RD	–999.0 to +9999 in Engineering Units
PV Range Low Loop2	54	0136	310	FP	RD	–999.0 to +9999 in Engineering Units
PV Range High Loop2	55	0137	311	FP	RD	–999.0 to +9999 in Engineering Units

Parameter		Register Address		Data Type	Access	Data Range or Enumerated Selection
Description	ID	Hex	Decimal			
Input Algorithm 1 Input A Selection (used with ID 204 math calculations)	205	00CD	205	INT	R/W	0 = Input 1 1 = Input 2 2 = Input 3 3 = Input 4 4 = Input 5 5 = Loop 1 Output 6 = Loop 2 Output 7 = Input Algorithm 1 8 = Input Algorithm 2
Input Algorithm 1 Input B Selection (used with ID 204 math calculations)	206	00CE	206	INT	R/W	0 = Input 1 1 = Input 2 2 = Input 3 3 = Input 4 4 = Input 5 5 = Loop 1 Output 6 = Loop 2 Output 7 = Input Algorithm 1 8 = Input Algorithm 2
Input Algorithm 1 Input C Selection (used with ID 204 math calculations)	207	00CF	207	INT	R/W	0 = None 1 = Input 1 2 = Input 2 3 = Input 3 4 = Input 4 5 = Input 5 6 = Loop 1 Output 7 = Loop 2 Output 8 = Input 1 Algorithm 9 = Input 2 Algorithm
Algorithm1 bias	92	005C	092	FP	R/W	-999.0 to 9999 in Engineering Units
Percent Carbon Monoxide	203	00CB	203	INT	R/W	0 = Manual 1 = On Line (via Input 3 only)
Percent Carbon Monoxide Value	46	002E	046	FP	R/W	0.02 to 0.350
Atmospheric Pressure	24	0018	024	FP	R/W	590 to 760
Percent Hydrogen	34	0022	034	FP	R/W	1 to 99 (% H2)

Parameter		Register Address		Data Type	Access	Data Range or Enumerated Selection
Description	ID	Hex	Decimal			
Input Algorithm 2 † Input source selected via ID 210, 211, 212.	209	00D1	209	INT	R/W	0 = None 1 = Weighted Average (LSP) † 2 = Feedforward – Summer † 3 = Feedforward – Multiplier † 4 = unused 5 = A-B/C 6 = Input High Select (with ratio and bias) † 7 = Input low Select (with ratio and bias) † 8 = General Math A (sq. rt., mult., div.) † 9 = General Math B (sq. rt., mult.) † 10 = General Math C (mult., div.) † 11 = General Math D (mult.) † 12 = Dewpoint
Constant K Algorithm 2	47	002F	047	FP	R/W	0.001 to 1000
Calc High Algorithm 2	51	0033	051	FP	R/W	–999.0 to +9999 in Engineering Units
Calc Low Algorithm 2	52	0034	052	FP	R/W	–999.0 to +9999 in Engineering Units
Input Algorithm 2 Input A Selection (used with ID 209 math calculations)	210	00D2	210	INT	R/W	0 = Input 1 1 = Input 2 2 = Input 3 3 = Input 4 4 = Input 5 5 = Loop 1 Output 6 = Loop 2 Output 7 = Input Algorithm 1 8 = Input Algorithm 2
Input Algorithm 2 Input B Selection (used with ID 209 math calculations)	211	00D3	211	INT	R/W	0 = Input 1 1 = Input 2 2 = Input 3 3 = Input 4 4 = Input 5 5 = Loop 1 Output 6 = Loop 2 Output 7 = Input Algorithm 1 8 = Input Algorithm 2

Parameter		Register Address		Data Type	Access	Data Range or Enumerated Selection
Description	ID	Hex	Decimal			
Input Algorithm 2 Input C Selection (used with ID 209 math calculations)	212	00D4	212	INT	R/W	0 = None 1 = Input 1 2 = Input 2 3 = Input 3 4 = Input 4 5 = Input 5 6 = Loop 1 Output 7 = Loop 2 Output 8 = Input 1 Algorithm 9 = Input 2 Algorithm
Algorithm2Bias	93	005D	93	FP	R/W	-999.0 to 9999 in Engineering Units

10.7.9 Math

Table 10-18 lists all the register addresses and ranges or selections for the function parameters in Set-up Group Math.

Table 10-18 Set-up Group – Math

Parameter		Register Address		Data Type	Access	Data Range or Enumerated Selection
Description	ID	Hex	Decimal			
8-Segment Characterizer 1	198	00C6	198	INT	R/W	0 = Disable 1 = Input 1 2 = Input 2 3 = Input 3 4 = Input 4 5 = Input 5 6 = Loop 1 – Output 7 = Loop 2 – Output
X0 Input to 8-Segment Characterizer 1	26	401A	16410	FP	R/W	0.00 to 99.99 %
X1 Input-Char1	27	401B	16411	FP	R/W	0.00 to 99.99 %
X2 Input-Char1	28	401C	16412	FP	R/W	0.00 to 99.99 %
X3 Input-Char1	29	401D	16413	FP	R/W	0.00 to 99.99 %
X4 Input-Char1	30	401E	16414	FP	R/W	0.00 to 99.99 %
X5 Input-Char1	31	401F	16415	FP	R/W	0.00 to 99.99 %
X6 Input-Char1	32	4020	16416	FP	R/W	0.00 to 99.99 %
X7 Input-Char1	33	4021	16417	FP	R/W	0.00 to 99.99 %
X8 Input-Char1	34	4022	16418	FP	R/W	0.00 to 99.99 %
Y0 Output from 8-Segment Characterizer 1	35	4023	16419	FP	R/W	0.00 to 99.99 %
Y1 Input-Char1	36	4024	16420	FP	R/W	0.00 to 99.99 %
Y2 Input-Char1	37	4025	16421	FP	R/W	0.00 to 99.99 %
Y3 Input-Char1	38	4026	16422	FP	R/W	0.00 to 99.99 %
Y4 Input-Char1	39	4027	16423	FP	R/W	0.00 to 99.99 %
Y5 Input-Char1	40	4028	16424	FP	R/W	0.00 to 99.99 %
Y6 Input-Char1	41	4029	16425	FP	R/W	0.00 to 99.99 %
Y7 Input-Char1	42	402A	16426	FP	R/W	0.00 to 99.99 %
Y8 Input-Char1	43	402B	16427	FP	R/W	0.00 to 99.99 %

Parameter		Register Address		Data Type	Access	Data Range or Enumerated Selection
Description	ID	Hex	Decimal			
8-Segment Characterizer 2	199	00C7	199	FP	R/W	0 = Disable 1 = Input 1 2 = Input 2 3 = Input 3 4 = Input 4 5 = Input 5 6 = Loop 1 – Output 7 = Loop 2 – Output 8 = LINK
X0 Input to 8-Segment Characterizer 2	45	402D	16429	FP	R/W	0.00 to 99.99 %
X1 Input-Char2	46	402E	16430	FP	R/W	0.00 to 99.99 %
X2 Input-Char2	47	402F	16431	FP	R/W	0.00 to 99.99 %
X3 Input-Char2	48	4030	16432	FP	R/W	0.00 to 99.99 %
X4 Input-Char2	49	4031	16433	FP	R/W	0.00 to 99.99 %
X5 Input-Char2	50	4032	16434	FP	R/W	0.00 to 99.99 %
X6 Input-Char2	51	4033	16435	FP	R/W	0.00 to 99.99 %
X7 Input-Char2	52	4034	16436	FP	R/W	0.00 to 99.99 %
X8 Input-Char2	53	4035	16437	FP	R/W	0.00 to 99.99 %
Y0 Output from 8-Segment Characterizer 2	54	4036	16438	FP	R/W	0.00 to 99.99 %
Y1 Output-Char2	55	4037	16439	FP	R/W	0.00 to 99.99 %
Y2 Output-Char2	56	4038	16440	FP	R/W	0.00 to 99.99 %
Y3 Output-Char2	57	4039	16441	FP	R/W	0.00 to 99.99 %
Y4 Output-Char2	58	403A	16442	FP	R/W	0.00 to 99.99 %
Y5 Output-Char2	59	403B	16443	FP	R/W	0.00 to 99.99 %
Y6 Output-Char2	60	403C	16444	FP	R/W	0.00 to 99.99 %
Y7 Output-Char2	61	403D	16445	FP	R/W	0.00 to 99.99 %
Y8 Output-Char2	62	403E	16446	FP	R/W	0.00 to 99.99 %
Totalizer	194	00C2	194	INT	R/W	0 = Disabled 1 = Input 1 2 = Input 2 3 = Input 3 4 = Input 4 5 = Input 5 6 = Input Algorithm 1 7 = Input Algorithm 2

Parameter		Register Address		Data Type	Access	Data Range or Enumerated Selection
Description	ID	Hex	Decimal			
Totalizer Scale Factor	195	00C3	195	INT	R/W	0 = 10 ⁰ 1 = 10 ¹ 2 = 10 ² 3 = 10 ³ 4 = 10 ⁴ 5 = 10 ⁵ 6 = 10 ⁶
Totalizer Reset Lock	196	00C4	196	INT	R/W	0 = Unlocked 1 = Locked
Totalizer Integration Rate	197	00C5	197	INT	R/W	0 = Second 1 = Minute 2 = Hour 3 = Day 4 = Million/Day
Totalizer Reset	177	00B1	177	INT	R/W	0 = No 1 = Yes
Polynomial	190	40BE	16574	INT	R/W	0 = Disable 1 = Input 1 2 = Input 2 3 = Input 3 4 = Input 4 5 = Input 5
Polynomial Coefficient C0	65	4041	16449	FP	R/W	-99.99 to 99.99
Polynomial Coefficient C1	66	4042	16450	FP	R/W	-9.999 to 9.999
Polynomial Coefficient C2	67	4043	16451	FP	R/W	-9.999 to 9.999
Polynomial Coefficient C3	68	4044	16452	FP	R/W	-9.999 to 9.999
Polynomial Coefficient C4	69	4045	16453	FP	R/W	-9.999 to 9.999
Polynomial Coefficient C5	70	4046	16453	FP	R/W	-9.999 to 9.999

10.7.10 Logic

Table 10-19 lists all the register addresses and ranges or selections for the function parameters in Set-up Group Logic

Table 10-19 Set-up Group – Logic

Parameter		Register Address		Data Type	Access	Data Range or Enumerated Selection
Description	ID	Hex	Decimal			
Logic Gates	150	4096	16534	INT	R/W	0 = Disable 1 = Enable
Gate 1 Type	151	4097	16535	INT	R/W	0 = Not Used 1 = OR 2 = NOR 3 = AND 4 = NAND 5 = XOR 6 = XNOR 7 = B LT A 8 = B GT A
Gate 2 Type	155	409B	16539	INT	R/W	Same as ID 151
Gate 3 Type	159	409F	16543	INT	R/W	Same as ID 151
Gate 4 Type	163	40A3	16547	INT	R/W	Same as ID 151
Gate 5 Type	167	40A7	16551	INT	R/W	Same as ID 151
Gate 1 InputA (OR, NOR, AND, NAND, X OR, X NOR)	152	4098	16536	INT	R/W	0 = Digital Input 1 1 = Digital Input 2 2 = Digital Input 3 3 = Digital Input 4 4 = Relay 1 5 = Relay 2 6 = Relay 3 7 = Relay 4 8 = Relay 5 9 = Gate Out 1 10 = Gate Out 2 11 = Gate Out 3 12 = Gate Out 4 13 = Gate Out 5 14 = FIX ON 15 = FIX OFF 16 = MA MODE 17 = LR SPL1 18 = ADAPT1 19 = MA MODE2 20 = LR SPL2 21 = ADAPT2

Parameter		Register Address		Data Type	Access	Data Range or Enumerated Selection
Description	ID	Hex	Decimal			
Gate 1 InputA (B LT A or B GT A)	171	40AB	16555	INT	R/W	0 = Input 1 1 = Input 2 2 = Input 3 3 = Input 4 4 = Input 5 5 = Loop1PV 6 = Loop1SP 7 = CONST K 8 = Loop 2 PV 9 = Loop 2 SP
Gate 1 InputB (OR, NOR, AND, NAND, X OR, X NOR)	153	4099	16537	INT	R/W	0 = Digital Input 1 1 = Digital Input 2 2 = Digital Input 3 3 = Digital Input 4 4 = Relay 1 5 = Relay 2 6 = Relay 3 7 = Relay 4 8 = Relay 5 9 = Gate Out 1 10 = Gate Out 2 11 = Gate Out 3 12 = Gate Out 4 13 = Gate Out 5 14 = FIX ON 15 = FIX OFF 16 = MA MODE 17 = LR SPL1 18 = ADAPT1 19 = MA MODE2 20 = LR SPL2 21 = ADAPT2
Gate 1 InputB (B LT A or B GT A)	172	40AC	16556	INT	R/W	0 = Input 1 1 = Input 2 2 = Input 3 3 = Input 4 4 = Input 5 5 = Loop1PV 6 = Loop1SP 7 = CONST K 8 = Loop 2 PV 9 = Loop 2 SP
Logic Gate1 K Constant	100	4064	16484	INT	R/W	-999.0 to +9999
Gate 2 InputA (OR, NOR, AND, NAND, X OR, X NOR)	156	409C	16540	INT	R/W	Same as ID 152

Parameter		Register Address		Data Type	Access	Data Range or Enumerated Selection
Description	ID	Hex	Decimal			
Gate 2 InputA (B LT A or B GT A)	173	40AD	16557	INT	R/W	Same as ID 171
Gate 2 InputB (OR, NOR, AND, NAND, X OR, X NOR)	157	409D	16541	INT	R/W	Same as ID 153
Gate 2 InputB (B LT A or B GT A)	174	40AE	16558	INT	R/W	Same as ID 172
Logic Gate2 K Constant	101	4065	16485	FP	R/W	-999.0 to +9999
Gate 3 InputA (OR, NOR, AND, NAND, X OR, X NOR)	160	40A0	16544	INT	R/W	Same as ID 152
Gate 3 InputA (B LT A or B GT A)	175	40AF	16559	INT	R/W	Same as ID 171
Gate 3 InputB (OR, NOR, AND, NAND, X OR, X NOR)	161	40A1	16545	INT	R/W	Same as ID 153
Gate 3 InputB (B LT A or B GT A)	176	40B0	16560	INT	R/W	Same as ID 172
Logic Gate3 K Constant	102	4066	16486	FP	R/W	-999.0 to +9999
Gate 4 InputA (OR, NOR, AND, NAND, X OR, X NOR)	164	40A4	16548	INT	R/W	Same as ID 152
Gate 4 InputA (B LT A or B GT A)	177	40B1	16561	INT	R/W	Same as ID 171
Gate 4 InputB (OR, NOR, AND, NAND, X OR, X NOR)	165	40A5	16549	INT	R/W	Same as ID 153
Gate 4 InputB (B LT A or B GT A)	178	40B2	16562	INT	R/W	Same as ID 172
Logic Gate4 K Constant	103	4067	16487	FP	R/W	-999.0 to +9999
Gate 5 InputA (OR, NOR, AND, NAND, X OR, X NOR)	168	40A8	16552	INT	R/W	Same as ID 152

Parameter		Register Address		Data Type	Access	Data Range or Enumerated Selection
Description	ID	Hex	Decimal			
Gate 5 InputA (B LT A or B GT A)	179	40B3	16563	INT	R/W	Same as ID 171
Gate 5 InputB (OR, NOR, AND, NAND, X OR, X NOR)	169	40A9	16553	INT	R/W	Same as ID 153
Gate 5 InputB (B LT A or B GT A)	180	40B4	16564	INT	R/W	Same as ID 172
Logic Gate5 K Constant	104	4068	16488	FP	R/W	-999.0 to +9999
Gate 1 Out	154	409A	16538	INT	R/W	0 = Relay 1 1 = Relay 2 2 = Relay 3 3 = Relay 4 4 = Relay 5 5 = Any Gate 6 = MA Mode 7 = LR SPL1 8 = ADAPT 1 9 = Reset Totalizer 10 = MA Mode Loop 2 11 = LR SP Loop 2 12 = Adapt Loop 2
Gate 2 Out	158	409E	16542	INT	R/W	Same as ID 154
Gate 3 Out	162	40A2	16546	INT	R/W	Same as ID 154
Gate 4 Out	166	40A6	16550	INT	R/W	Same as ID 154
Gate 5 Out	170	40AA	16554	INT	R/W	Same as ID 154

10.7.11 Output Algorithms

Table 10-20 lists all the register addresses and ranges or selections for the function parameters in Set-up Group Output Algorithms.

Table 10-20 Set-up Group – Output Algorithms

Parameter		Register Address		Data Type	Access	Data Range or Enumerated Selection
Description	ID	Hex	Decimal			
Output Algorithm	160	00A0	160	INT	R/W	0 = Time Simplex 1 = Current Simplex 2 = Three Position Step or Position Proportioning 3 = Time Duplex 4 = Current Duplex 5 = Current/Time Duplex 6 = Time/Current Duplex
Relay Cycle Time Increments	190	00BE	190	INT	R/W	0 = 1 second increments 1 = 1/3 second increments
Motor Time for Positional Proportional	75	004B	075	INT	R/W	5 to 1800 seconds
Relay Output Action	243	00F3	243	INT	R/W	0 = 1 OFF 2 OFF 1 = 1 ON 2 OFF 2 = 1 OFF 2 ON 3 = 1 ON 2 ON
Current Range for Current Duplex	153	0099	153	INT	R/W	0 = Full (100%) 1 = Split (50%)
Output Algorithm Loop2	160	01A0	416	INT	R/W	0 = Time Simplex 1 = Current Simplex 2 = None 3 = Not Used 4 = Current Duplex 5 = Current/Time 6 = Time/Current 7 = Time Duplex
Relay Output Action Loop2	175	01AF	431	INT	R/W	0 = 1 OFF 2 OFF 1 = 1 ON 2 OFF 2 = 1 OFF 2 ON 3 = 1 ON 2 ON
Current Range for Current Duplex Loop2	153	0199	409	INT	R/W	0 = 100% 1 = 50%

Parameter		Register Address		Data Type	Access	Data Range or Enumerated Selection
Description	ID	Hex	Decimal			
C2 Range	236	00EC	236	INT	R/W	0 = 4-20 mA 1 = 0 -20 mA
Current Output 1	242	00F2	242	INT	R/W	0 = Disable 1 = Input 1 2 = Input 2 3 = Input 3 4 = Input 4 5 = Input 5 6 = PV 7 = CB Out 8 = DEV 9 = Output 10 = SP 11 = LSP 12 = RSP 13 = In Alg 1 14 = In Alg 2 15 = PV2 16 = CBOU2 17 = DEV 2 18 = Output Loop 2 19 = SP Loop 2 20 = LSP1 Loop 2 21 = RSP Loop 2
Current Output 1 Range	235	00EA	235	INT	R/W	0 = 4-20 mA 1 = 0-20 mA
Current 1 Low Scaling Factor	100	0064	100	FP	R/W	Within the range of the selected variable in ID 242
Current 1 High Scaling Factor	101	0065	101	FP	R/W	Within the range of the selected variable in ID 242

10.7.12 Input 1

Table 10-21 lists all the register addresses and ranges or selections for the function parameters in Set-up Group Input 1.

Table 10-21 Set-up Group – Input 1

Parameter		Register Address		Data Type	Access	Data Range or Enumerated Selection
Description	ID	Hex	Decimal			
Input 1 Type	168	00A8	168	INT	R/W	1 = B TC 2 = E TC H 3 = E TC L 4 = J TC H 5 = J TC M 6 = J TC L 7 = K TC H 8 = K TC M 9 = K TC L 10 = NNM H 11 = NNM L 12 = Nicrosil H TC 13 = Nicrosil L TC 14 = Plat H 15 = Plat L 16 = R TC 17 = S TC 18 = T TC H 19 = T TC L 20 = W TC H 21 = W TC L 22 = 100 PT RTD 23 = 100 PT LO RTD 24 = 200 PT RTD 25 = 500 PT RTD 26 = 1000PT 27 = Radiamatic RH 28 = Radiamatic RI 29 = 0-20 mA 30 = 4-20 mA 31 = 0-10 mV 32 = 0-50 mV 33 = 100 mV 34 = 0-500mV 35 = -10-10mV 36 = 0-1V 37 = 0-5 Vdc 38 = 1-5 Vdc 39 = 0-10 Vdc 40 = -1-1V 41 = Unused 42 = Carbon 43 = Oxygen 44 = Thermocouple Differential 45 = Unused 46 = PR
ATTENTION						

Parameter		Register Address		Data Type	Access	Data Range or Enumerated Selection
Description	ID	Hex	Decimal			
Changing the Input Type will result in the loss of Field Calibration values and will restore the Factory Calibration values.						
Input 1 Transmitter Characterization	169	00A9	169	INT	R/W	0 = B TC 1 = E TC H 2 = E TC L 3 = J TC H 4 = J TC M 5 = J TC L 6 = K TC H 7 = K TC M 8 = K TC L 9 = NNM H 10 = NNM L 11 = Nicrosil H TC 12 = Nicrosil L TC 13 = Plat H 14 = Plat L 15 = R TC 16 = S TC 17 = T TC H 18 = T TC L 19 = W TC H 20 = W TC L 21 = 100 PT RTD 22 = 100 PT LO RTD 23 = 200 PT RTD 24 = 500 PT RTD 25 = 1000PT 26 = Radiamatic RH 27 = Radiamatic RI 28 = Linear 29 = Square Root
Input 1 High Range Value	29	001D	029	FP	R/W	-999. to 9999. Engineering Units (Linear types only)
Input 1 Low Range Value	30	001E	030	FP	R/W	-999 to 9999. Engineering Units (Linear types only)
Input 1 Ratio	106	006A	106	FP	R/W	-20.00 to 20.00
Input 1 Bias	107	006B	107	FP	R/W	-999 to 9999. Engineering Units
Input 1 Filter	42	002A	042	FP	R/W	0 to 120 seconds
Burnout (Open Circuit Detection)	164	00A4	164	INT	R/W	0 = None and Failsafe 1 = Upscale 2 = Downscale 3 = No Failsafe
Emissivity	23	0017	023	FP	R/W	0.01 to 1.00

10.7.13 Input 2

Table 10-22 lists all the register addresses and ranges or selections for the function parameters in Set-up Group Input 2.

Table 10-22 Set-up Group – Input 2

Parameter		Register Address		Data Type	Access	Data Range or Enumerated Selection
Description	ID	Hex	Decimal			
Input 2 Type	170	00AA	170	INT	R/W	0 = Disable 1 = B TC 2 = E TC H 3 = E TC L 4 = J TC H 5 = J TC M 6 = J TC L 7 = K TC H 8 = K TC M 9 = K TC L 10 = NNM H 11 = NNM L 12 = Nicrosil H TC 13 = Nicrosil L TC 14 = Plat H 15 = Plat L 16 = R TC 17 = S TC 18 = T TC H 19 = T TC L 20 = W TC H 21 = W TC L 22 = 100 PT RTD 23 = 100 PT LO RTD 24 = 200 PT RTD 25 = 500 PT RTD 26 = 1000PT 27 = Radiamatic RH 28 = Radiamatic RI 29 = 0-20 mA 30 = 4-20 mA 31 = 0-10 mV 32 = 0-50 mV 33 = 0-100 mV 34 = 0-500mV 35 = -10-10mV 36 = 0-1V 37 = 0-5 Vdc 38 = 1-5 Vdc 39 = 0-10 Vdc 40 = -1-1V 41 = Unused 42 = Unused 43 = Unused 44 = Thermocouple Differential 45 = Unused 46 = PR

Parameter		Register Address		Data Type	Access	Data Range or Enumerated Selection
Description	ID	Hex	Decimal			
ATTENTION						
Changing the Input Type will result in the loss of Field Calibration values and will restore the Factory Calibration values.						
Input 2 Transmitter Characterization	171	00AB	171	INT	R/W	0 = B TC 1 = E TC H 2 = E TC L 3 = J TC H 4 = J TC M 5 = J TC L 6 = K TC H 7 = K TC M 8 = K TC L 9 = NNM H 10 = NNM L 11 = Nicrosil H TC 12 = Nicrosil L TC 13 = Plat H 14 = Plat L 15 = R TC 16 = S TC 17 = T TC H 18 = T TC L 19 = W TC H 20 = W TC L 21 = 100 PT RTD 22 = 100 PT LO RTD 23 = 200 PT RTD 24 = 500 PT RTD 25 = 1000PT 26 = Radiamatic RH 27 = Radiamatic RI 28 = Linear 29 = Square Root
Input 2 High Range Value	035	0023	035	FP	R/W	-999. to 9999. Engineering Units
Input 2 Low Range Value	036	0024	036	FP	R/W	-999 to 9999. Engineering Units
Input 2 Ratio	037	0025	037	FP	R/W	-20.00 to 20.00
Input 2 Bias	038	0026	038	FP	R/W	-999 to 9999. Engineering Units
Input 2 Filter	43	002B	043	FP	R/W	0 to 120 seconds
Input 2 Emissivity	44	002C	044	FP	R/W	0.01 to 1.00
Input 2 Burnout	165	00A5	165	INT	R/W	0 = None 1 = Up 2 = Down 3 = No Failsafe

10.7.14 Input 3

Table 10-23 lists all the register addresses and ranges or selections for the function parameters in Set-up Group Input 3.

Table 10-23 Set-up Group – Input 3

Parameter		Register Address		Data Type	Access	Data Range or Enumerated Selection
Description	ID	Hex	Decimal			
Input 3 Type	128	4080	16512	INT	R/W	0 = Disable 1 = B TC 2 = E TC H 3 = E TC L 4 = J TC H 5 = J TC M 6 = J TC L 7 = K TC H 8 = K TC M 9 = K TC L 10 = NNM H 11 = NNM L 12 = Nicrosil H TC 13 = Nicrosil L TC 14 = Plat H 15 = Plat L 16 = R TC 17 = S TC 18 = T TC H 19 = T TC L 20 = W TC H 21 = W TC L 22 = 100 PT RTD 23 = 100 PT LO RTD 24 = 200 PT RTD 25 = 500 PT RTD 26 = 1000PT 27 = Radiamatic RH 28 = Radiamatic RI 29 = 0-20 mA 30 = 4-20 mA 31 = 0-10 mV 32 = 0-50 mV 33 = 0-100 mV 34 = 0-500mV 35 = -10-10mV 36 = 0-1V 37 = 0-5 Vdc 38 = 1-5 Vdc 39 = 0-10 Vdc 40 = -1-1V 41 = Slidewire 42 = Unused 43 = Unused 44 = Thermocouple Differential 45 = SW EMUL 46 = PR

Parameter		Register Address		Data Type	Access	Data Range or Enumerated Selection
Description	ID	Hex	Decimal			
ATTENTION						
Changing the Input Type will result in the loss of Field Calibration values and will restore the Factory Calibration values.						
Input 3 Transmitter Characterization	129	4081	16513	INT	R/W	0 = B TC 1 = E TC H 2 = E TC L 3 = J TC H 4 = J TC M 5 = J TC L 6 = K TC H 7 = K TC M 8 = K TC L 9 = NNM H 10 = NNM L 11 = Nicrosil H TC 12 = Nicrosil L TC 13 = Plat H 14 = Plat L 15 = R TC 16 = S TC 17 = T TC H 18 = T TC L 19 = W TC H 20 = W TC L 21 = 100 PT RTD 22 = 100 PT LO RTD 23 = 200 PT RTD 24 = 500 PT RTD 25 = 1000PT 26 = Radiamatic RH 27 = Radiamatic RI 28 = Linear 29 = Square Root
Input 3 High Range Value	27	001B	27	FP	R/W	-999. to 9999. Engineering Units
Input 3 Low Range Value	28	001C	28	FP	R/W	-999 to 9999. Engineering Units
Input 3 Ratio	104	0068	104	FP	R/W	-20.00 to 20.00
Input 3 Bias	105	0069	105	FP	R/W	-999 to 9999. Engineering Units
Input 3 Filter	33	0021	33	FP	R/W	0 to 120 seconds
Input 3 Emissivity	23	4017	16407	FP	R/W	0.01 to 1.00
Input 3 Burnout	130	4082	16514	INT	R/W	0 = None 1 = Up 2 = Down 3 = No Failsafe

10.7.15 Input 4

Table 10-24 lists all the register addresses and ranges or selections for the function parameters in Set-up Group Input 4.

Table 10-24 Set-up Group – Input 4

Parameter		Register Address		Data Type	Access	Data Range or Enumerated Selection
Description	ID	Hex	Decimal			
Input 4 Type	131	4083	16515	INT	R/W	0 = Disable 1 – 0-20mA 2 = 4-20mA 3 = 0-5V 4 = 1-5V
ATTENTION						
Changing the Input Type will result in the loss of Field Calibration values and will restore the Factory Calibration values.						
Input 4 Transmitter Characterization	132	4084	16516	INT	R/W	0 = B TC 1 = E TC H 2 = E TC L 3 = J TC H 4 = J TC M 5 = J TC L 6 = K TC H 7 = K TC M 8 = K TC L 9 = NNM H 10 = NNM L 11 = Nicrosil H TC 12 = Nicrosil L TC 13 = Plat H 14 = Plat L 15 = R TC 16 = S TC 17 = T TC H 18 = T TC L 19 = W TC H 20 = W TC L 21 = 100 PT RTD 22 = 100 PT LO RTD 23 = 200 PT RTD 24 = 500 PT RTD 25 = 1000PT 26 = Radiamatic RH 27 = Radiamatic RI 28 = Linear 29 = Square Root
Input 4 High Range Value	95	005F	95	FP	R/W	–999. to 9999. Engineering Units

Parameter		Register Address		Data Type	Access	Data Range or Enumerated Selection
Description	ID	Hex	Decimal			
Input 4 Low Range Value	96	0060	96	FP	R/W	–999 to 9999. Engineering Units
Input 4 Ratio	97	0061	97	FP	R/W	–20.00 to 20.00
Input 4 Bias	98	0062	98	FP	R/W	–999 to 9999. Engineering Units
Input 4 Filter	94	005E	94	FP	R/W	0 to 120 seconds
Input 4 Burnout	133	4085	16517	INT	R/W	0 = None 1 = Up 2 = Down 3 = No Failsafe

10.7.16 Input 5

Table 10-25 lists all the register addresses and ranges or selections for the function parameters in Set-up Group Input 5.

Table 10-25 Set-up Group – Input 5

Parameter		Register Address		Data Type	Access	Data Range or Enumerated Selection
Description	ID	Hex	Decimal			
Input 5 Type	134	4086	16518	INT	R/W	0 = Disable 1 = 0-20mA 2 = 4-20mA 3 = 0-5V 4 = 1-5V
ATTENTION						
Changing the Input Type will result in the loss of Field Calibration values and will restore the Factory Calibration values.						
Input 5 Transmitter Characterization	135	4087	16519	INT	R/W	0 = B TC 1 = E TC H 2 = E TC L 3 = J TC H 4 = J TC M 5 = J TC L 6 = K TC H 7 = K TC M 8 = K TC L 9 = NNM H 10 = NNM L 11 = Nicrosil H TC 12 = Nicrosil L TC 13 = Plat H 14 = Plat L 15 = R TC 16 = S TC 17 = T TC H 18 = T TC L 19 = W TC H 20 = W TC L 21 = 100 PT RTD 22 = 100 PT LO RTD 23 = 200 PT RTD 24 = 500 PT RTD 25 = 1000PT 26 = Radiamatic RH 27 = Radiamatic RI 28 = Linear 29 = Square Root
Input 5 High Range Value	82	0052	82	FP	R/W	-999. to 9999. Engineering Units

Parameter		Register Address		Data Type	Access	Data Range or Enumerated Selection
Description	ID	Hex	Decimal			
Input 5 Low Range Value	83	0053	83	FP	R/W	-999 to 9999. Engineering Units
Input 5 Ratio	84	0054	84	FP	R/W	-20.00 to 20.00
Input 5 Bias	85	0055	85	FP	R/W	-999 to 9999. Engineering Units
Input 5 Filter	81	0051	81	FP	R/W	0 to 120 seconds
Input 5 Burnout	136	4088	16520	INT	R/W	0 = None 1 = Up 2 = Down 3 = No Failsafe

10.7.17 Control

Table 10-26 lists all the register addresses and ranges or selections for the function prompts in Set-up Group Control.

Table 10-26 Set-up Group – Control

Parameter		Register Address		Data Type	Access	Data Range or Enumerated Selection
Description	ID	Hex	Decimal			
PV Source	133	0085	133	INT	R/W	0 = Input 1 1 = Input 2 2 = Input 3 3 = Input 4 4 = Input 5 5 = Input AL1 6 = Input AL2
Tuning Parameter Selection	172	00AC	172	INT	R/W	0 = One set only 1 = 2 sets keyboard selected 2 = 2 sets with PV automatic switchover 3 = 2 sets with setpoint (SP) automatic switchover 4 = Four sets Keyboard 5 = Four sets PV switch 6 = Four sets SP switch
Automatic Switchover Value PID1 to PID2 (used with ID172)	56	0038	056	FP	R/W	Within the PV Range in engineering units
Automatic Switchover Value PID2 to PID3 (used with ID172)	9	4009	16393	FP	R/W	Within the PV Range in engineering units
Automatic Switchover Value PID3 to PID4 (used with ID 172)	10	400A	16394	FP	R/W	Within the PV Range in engineering units
Local Setpoint Source (Number of LSPs)	173	00AD	173	INT	R/W	0 = One Local Setpoint 1 = Two Local Setpoints 2 = Three Local Setpoints 3 = Four LSP

Parameter		Register Address		Data Type	Access	Data Range or Enumerated Selection
Description	ID	Hex	Decimal			
Power Up Mode Recall	130	0082	130	INT	R/W	Control Setpoint Mode Mode 0 = MAN LSP1 1 = AUTO LSP1 2 = AUTO Last RSP 3 = LAST Last SP 4 = LAST Last Local SP
RSP Source	131	0083	131	INT	R/W	0 = None 1 = Input 1 2 = Input 2 3 = Input 3 4 = Input 4 5 = Input 5 6 = Alg 1 7 = Alg 2
Setpoint Tracking	138	008A	138	INT	R/W	0 = None 1 = LSP = PV (when in Manual) 2 = LSP = RSP (when switched)
Auto Bias	137	0089	137	INT	R/W	0 = Disable 1 = Enable
Control Setpoint High Limit	7	0007	007	FP	R/W	0 to 100% of PV (engineering units)
Control Setpoint Low Limit	8	0008	008	FP	R/W	0 to 100% of PV (engineering units)
Control Output Direction	135	0087	135	INT	R/W	0 = Direct 1 = Reverse
Output Rate Enable	156	009C	156	INT	R/W	0 = Disable 1 = Enable
Output Rate Up	110	006E	110	FP	R/W	0.00 to 9999% per minute
Output Rate Down	111	006F	111	FP	R/W	0.00 to 9999% per minute
High Output Limit	14	000E	014	FP	R/W	-5 to 105% of output
Low Output Limit	15	000F	015	FP	R/W	-5 to 105% of output
High Integral Limit	16	0010	016	FP	R/W	-5 to 105%
Low Integral Limit	17	0011	017	FP	R/W	-5 to 105%

Parameter		Register Address		Data Type	Access	Data Range or Enumerated Selection
Description	ID	Hex	Decimal			
Output Deadband for Time Duplex	18	0012	018	FP	R/W	-5 to +25.0%
Output Deadband for TPSC	76	004C	076	FP	R/W	0.5 to 5.0%
Output Drop Off Limit	20	0014	020	FP	R/W	-5 to 105%
Output Hysteresis	19	0013	019	FP	R/W	0.0 to 100.0% of PV
Failsafe Mode	213	00D5	213	INT	R/W	0 = Latching 1 = Non latching
Failsafe Output Level	40	0028	040	FP	R/W	0 to 100%
TPSC Power Output	183	00B7	183	INT	R/W	0 = Last 1 = Failsafe
TPSC Failsafe Output	184	00B8	184	INT	R/W	0 = Motor goes to closed position (0%) 1 = Motor goes to open position (100%)
Manual Output	113	0071	113	FP	R/W	0 to 100%
Automatic Output	114	0072	114	FP	R/W	0 to 100%
Proportional Band Units	148	0094	148	INT	R/W	0 = Gain 1 = Proportional band
Reset Units	149	0095	149	INT	R/W	0 = Minutes 1 = RPM

10.7.18 Control Loop 2

Table 10-27 lists all the register addresses and ranges or selections for the function prompts in Set-up Group Control2.

Table 10-27 Set-up Group – Control2

Parameter		Register Address		Data Type	Access	Data Range or Enumerated Selection
Description	ID	Hex	Decimal			
PV Source Loop2	133	0185	389	INT	R/W	0 = Input 1 1 = Input 2 2 = Input 3 3 = Input 4 4 = Input 5 5 = Input Algorithm 1 6 = Input Algorithm 2 7 = None
Link Modes and Set Point	132	0184	388	INT	R/W	0 = Disable 1 = AutoMan 2 = SP1 3 = AM + SP1
Tuning Parameter Selection Loop2	172	01AC	428	INT	R/W	0 = One set only 1 = 2 sets keyboard selected 2 = 2 sets with PV automatic switchover 3 = 2 sets with setpoint (SP) automatic switchover 4 = Four sets Keyboard 5 = Four sets Auto Switch PV 6 = Four sets Auto Switch SP
Automatic Loop2 Switchover Value PID1 to PID2 (used with ID 172)	9	0109	265	FP	R/W	Within the PV Range in engineering units
Automatic Loop2 Switchover Value PID2 to PID3 (used with ID 172)	10	010A	266	FP	R/W	Within the PV Range in engineering units
Automatic Loop2 Switchover Value PID3 to PID4 (used with ID 172)	11	010B	267	FP	R/W	Within the PV Range in engineering units

Parameter		Register Address		Data Type	Access	Data Range or Enumerated Selection												
Description	ID	Hex	Decimal															
Local Setpoint Source (Number of LSPs) Loop2	173	01AD	429	INT	R/W	0 = One Local Setpoint 1 = Two Local Setpoints 2 = Three Local Setpoints 3 = Four Local Setpoints												
RSP Source Loop2	131	0183	387	INT	R/W	0 = None 1 = Input 1 2 = Input 2 3 = Input 3 4 = Input 4 5 = Input 5 6 = Input Algorithm 1 7 = Input Algorithm 2												
Setpoint Tracking Loop2	138	018A	394	INT	R/W	0 = None 1 = LSP = PV (when in Manual) 2 = LSP = RSP (when switched)												
Auto Bias Loop2	137	0189	393	INT	R/W	0 = Disable 1 = Enable												
Power Up Mode Recall Loop2	130	0182	386	INT	R/W	<table border="0"> <tr> <td>Control Mode</td> <td>Setpoint Mode</td> </tr> <tr> <td>0 = MAN</td> <td>LSP</td> </tr> <tr> <td>1 = AUTO</td> <td>LSP</td> </tr> <tr> <td>2 = AUTO</td> <td>Last RSP</td> </tr> <tr> <td>3 = LAST</td> <td>Last SP</td> </tr> <tr> <td>4 = LAST</td> <td>Last Local SP</td> </tr> </table>	Control Mode	Setpoint Mode	0 = MAN	LSP	1 = AUTO	LSP	2 = AUTO	Last RSP	3 = LAST	Last SP	4 = LAST	Last Local SP
Control Mode	Setpoint Mode																	
0 = MAN	LSP																	
1 = AUTO	LSP																	
2 = AUTO	Last RSP																	
3 = LAST	Last SP																	
4 = LAST	Last Local SP																	
Control Setpoint High Limit Loop2	7	0107	263	FP	R/W	0 to 100% of PV (engineering units)												
Control Setpoint Low Limit Loop2	8	0108	264	FP	R/W	0 to 100% of PV (engineering units)												
Control Output Direction	135	0187	391	INT	R/W	0 = Direct 1 = Reverse												
Output Rate Enable	156	019C	412	INT	R/W	0 = Disable 1 = Enable												
Output Rate Up	110	016E	366	FP	R/W	0.00 to 9999% per minute												
Output Rate Down	111	016F	367	FP	R/W	0.00 to 9999% per minute												
High Output Limit	14	010E	270	FP	R/W	-5 to 105% of output												
Low Output Limit	15	010F	271	FP	R/W	-5 to 105% of output												
High Integral Limit	16	0110	272	FP	R/W	-5 to 105%												

Parameter		Register Address		Data Type	Access	Data Range or Enumerated Selection
Description	ID	Hex	Decimal			
Low Integral Limit	17	0101	273	FP	R/W	-5 to 105%
Output Deadband for Time Duplex	18	0102	274	FP	R/W	-5 to +25.0%
Output Drop Off Limit	20	0114	276	FP	R/W	-5 to 105%
Failsafe Mode	159	019F	415	INT	R/W	0 = Latching 1 = Non latching
Failsafe Output Level	40	0128	296	FP	R/W	0 to 100%

10.7.19 Options

Table 10-28 lists all the register addresses and ranges or selections for the function parameters in Set-up Group Options.

Table 10-28 Set-up Group – Options

Parameter		Register Address		Data Type	Access	Data Range or Enumerated Selection
Description	ID	Hex	Decimal			
Current Output2 (Aux Output)*	134	0086	134	INT	R/W	0 = None 1 = Input 1 2 = Input 2 3 = Input 3 4 = Input 4 5 = Input 5 6 = PV 7 = CB OUT 8 = Dev 9 = Out 10 = SP 11 = LSP 1 12 = RSP 13 = Input ALG 1 14 = Input ALG 2 15 = PV 2 16 = CBOU2L2 17 = DEV2 18 = Output 2 19 = SP Loop 2 20 = LSP1 Loop 2 21 = RSP Loop 2
Current Output 2 Low Scaling Factor	49	0031	049	FP	R/W	Within the range of the selected variable in ID 134
Current Output 2 High Scaling Factor	50	0032	050	FP	R/W	Within the range of the selected variable in ID 134
Current Output 2 Range	236	00EB	236	INT	R/W	0 = 4-20 mA 1 = 0-20 mA

Parameter		Register Address		Data Type	Access	Data Range or Enumerated Selection
Description	ID	Hex	Decimal			
Current Output 3	246	00F6	246	INT	R/W	0 = None 1 = Input 1 2 = Input 2 3 = Input 3 4 = Input 4 5 = Input 5 6 = PV 7 = CB OUT 8 = Dev 9 = Out 10 = SP 11 = LSP 1 12 = RSP 13 = Input ALG 1 14 = Input ALG 2 15 = PV 2 16 = CBOU2L2 17 = DEV2 18 = Output Loop 2 19 = SP Loop 2 20 = LSP1 Loop 2 21 = RSP Loop 2
Current Output 3 Low Scaling Factor	86	0056	86	FP	R/W	Within the range of the selected variable in ID 246
Current Output 3 High Scaling Factor	87	0057	87	FP	R/W	Within the range of the selected variable in ID 134
Current Output 3 Range	247	00F7	247	INT	R/W	0 = 4-20 mA 1 = 0-20 mA

Parameter		Register Address		Data Type	Access	Data Range or Enumerated Selection
Description	ID	Hex	Decimal			
Digital Input #1	186	00BA	186	INT	R/W	0 = Disable 1 = To Manual 2 = To Local Setpoint #1 3 = To Local Setpoint #2 4 = To Local Setpoint #3 5 = To Local Setpoint #4 6 = To Direct Action 7 = To Hold Ramp 8 = To PID 2 9 = To PID 3 10 = To PID 4 11 = PV = Input 2 12 = PV = Input 3 13 = Rerun SPP Cycle 14 = To Run Ramp 15 = Reset SP Program 16 = Inhibit Reset 17 = To Manual/Failsafe Output 18 = Disable Keyboard 19 = To Automatic Output 20 = To Timer 21 = To Auto/Man Station 22 = Initiate Limit Cycle Tuning 23 = Setpoint Initialization (SP=PV) 24 = Output Tracks Input 2 25 = Track 2 26 = To Out 2 (Output 2 overrides Output 1) 27 = To RSP 28 = Display Other Loop on Closure 29 = External Reset Feedback 30 = To Purge 31 = To Purge AX 32 = To Low Fire 33 = Manual Latching 34 = Rest Totalizer 35 = PV Hold 36 = Reset T1 37 = Reset T2 38 = Reset T3 39 = R All Timers 40 = Counter 1 41 = Counter 2 42 = Counter 3 43 = Reset all Counters 44 = Reset all Timers

Parameter		Register Address		Data Type	Access	Data Range or Enumerated Selection
Description	ID	Hex	Decimal			
Digital Input #1 Combinations	188	00BC	188	INT	R/W	0 = Disable 1 = +PID2 2 = +Direct 3 = +LSP2 4 = +Disable Accutune 5 = +LSP1 6 = +Run 7 = +ToSP3
Digital Input #2	187	00BB	187	INT	R/W	Same as Digital Input #1
Digital Input #2 Combinations	189	00BC	189	INT	R/W	0 = Disable 1 = +PID2 2 = +Direct 3 = +LSP2 4 = +Disable Accutune 5 = +LSP1 6 = +Run 7 = +ToSP3
Digital Input #3	174	00AE	174	INT	R/W	Same as Digital Input #1
Digital Input #4	175	00AF	175	INT	R/W	Same as Digital Input #1
DI Loop Assignment, DI on Loop 2	136	0088	136	INT	R/W	0 = None 1 = DI 2 2 = DI 2,3 3 = DI 2,3,4
Digital Inputs Loop 2 Assign	189	01BD	445	INT	R/W	0 = None 1 = DI 2 2 = DI 2,3 3 = DI 2,3,4

10.7.20 Communications

Table 10-29 lists all the register addresses and ranges or selections for the function parameters in Set-up Group Communications.

Table 10-29 Set-up Group – Communications

Parameter		Register Address		Data Type	Access	Data Range or Enumerated Selection
Description	ID	Hex	Decimal			
Shed Time	79	004F	79	INT	R/W	0 = No Shed 1 = 255 sample periods
Shed Mode and Output	162	00A2	162	INT	R/W	0 = Last Mode and Last Output 1 = Manual Mode, Last Output 2 = Manual Mode, Failsafe Output 3 = Automatic Mode
Shed Setpoint Recall	163	00A3	163	INT	R/W	0 = To Last Local Setpoint used 1 = CSP
Computer Setpoint Ratio	90	005A	90	FP	R/W	-20.00 to 20.00
Computer Setpoint Bias	91	005B	91	FP	R/W	-999 to 9999.
Loop2 Computer Setpoint Ratio	90	015A	346	FP	R/W	-20.00 to 20.00
Loop2 Computer Setpoint Bias	91	015B	347	FP	R/W	-999 to 9999.
Communication Address	77	004D	77	FP	R/W	1 - 99
Communications Type	231	00E7	231	INT	R/W	0 = None 1 = Disable 2 = RS-485 Modbus 3 = Ethernet only if installed
IR Port Enable	241	00F1	241	INT	R/W	0 = Disable 1 = Enable
Baud Rate	232	00E8	232	INT	R/W	0 = 4800 1 = 9600 2 = 19200 3 = 38400
Transmit Delay	78	004E	78	FP	R/W	Response Delay in ms (1 to 500) +6ms

Parameter		Register Address		Data Type	Access	Data Range or Enumerated Selection
Description	ID	Hex	Decimal			
Floating Point Byte Order	233	00E9	233	INT	R/W	0 = Big Endian 1 = Big Endian Byte Swap 2 = Little Endian 3 = Little Endian Byte Swap
Shed Enable	234	00EA	234	INT	R/W	0 = Enable 1 = Disable
Shed Time	79	004F	79	INT	R/W	0 = No Shed 1 = 255 sample periods
Comm Data Units	161	00A1	161	INT	R/W	0 = Percent 1 = Engineering Units

10.7.21 Alarms

Table 10-30 lists all the register addresses and ranges or selections for the function parameters in Set-up Group Alarms.

Table 10-30 Set-up Group – Alarms

Parameter		Register Address		Data Type	Access	Data Range or Enumerated Selection
Description	ID	Hex	Decimal			
Alarm 1 Setpoint 1 Value	009	0009	009	FP	R/W	Within the range of selected parameter or PV span for deviation alarm
Alarm 1 Setpoint 2 Value	010	000A	010	FP	R/W	Within the range of selected parameter or PV span for deviation alarm
Alarm 2 Setpoint 1 Value	011	000B	011	FP	R/W	Within the range of selected parameter or PV span for deviation alarm
Alarm 2 Setpoint 2 Value	012	000C	012	FP	R/W	Within the range of selected parameter or PV span for deviation alarm
Alarm 3 Setpoint 1 Value	117	0075	117	FP	R/W	Within the range of selected parameter or PV span for deviation alarm
Alarm 3 Setpoint 2 Value	118	0076	118	FP	R/W	Within the range of selected parameter or PV span for deviation alarm
Alarm 4 Setpoint 1 Value	119	0077	119	FP	R/W	Within the range of selected parameter or PV span for deviation alarm
Alarm 4 Setpoint 2 Value	115	0073	115	FP	R/W	Within the range of selected parameter or PV span for deviation alarm

Parameter		Register Address		Data Type	Access	Data Range or Enumerated Selection
Description	ID	Hex	Decimal			
Alarm 1 Setpoint 1 Type	140	008C	140	INT	R/W	0 = None 1 = Input 1 2 = Input 2 3 = Input 3 4 = Input 4 5 = Input 5 6 = PV 7 = Deviation 8 = Output 9 = Alarm on Shed 10 = SP Event On 11 = SP Event Off 12 = Manual 13 = Remote Setpoint 14 = Failsafe 15 = PV Rate of Change 16 = Alarm on Digital Input 1 17 = Alarm on Digital Input 2 18 = Alarm on Digital Input 3 19 = Alarm on Digital Input 4 20 = Loop Break 21 = T/C Warning 22 = T/C Fail 23 = PV Hold 24 = Total 25 = PV 2 26 = DEV 2 27 = OUT 2 28 = MAN 2 29 = RSP 2 30 = Failsafe 2 31 = PV Rate 2 32 = Break 2 33 = PV2Hold 34 = Timer 1 35 = Timer 2 36 = Timer 3 37 = Counter 1 38 = Counter 2 39 = Counter 3
Alarm 1 Setpoint 2 Type	142	008E	142	INT	R/W	Same as 140
Alarm 2 Setpoint 1 Type	144	0090	144	INT	R/W	Same as 140
Alarm 2 Setpoint 2 Type	146	0092	146	INT	R/W	Same as 140
Alarm 3 Setpoint 1 Type	140	408C	16524	INT	R/W	Same as 140

Parameter		Register Address		Data Type	Access	Data Range or Enumerated Selection
Description	ID	Hex	Decimal			
Alarm 3 Setpoint 2 Type	142	408E	16526	INT	R/W	Same as 140
Alarm 4 Setpoint 1 Type	144	4090	16528	INT	R/W	Same as 140
Alarm 4 Setpoint 2 Type	146	4092	16530	INT	R/W	Same as 140
Alarm 1 Setpoint 1 Event	141	008D	141	INT	R/W	0 = Low Alarm 1 = High Alarm
Alarm 1 Setpoint 2 Event	143	008F	143	INT	R/W	0 = Low Alarm 1 = High Alarm
Alarm 2 Setpoint 1 Event	145	0091	145	INT	R/W	0 = Low Alarm 1 = High Alarm
Alarm 2 Setpoint 2 Event	147	0093	147	INT	R/W	0 = Low Alarm 1 = High Alarm
Alarm 3 Setpoint 1 Event	141	409D	16525	INT	R/W	0 = Low Alarm 1 = High Alarm
Alarm 3 Setpoint 2 Event	144	4090	16527	INT	R/W	0 = Low Alarm 1 = High Alarm
Alarm 4 Setpoint 1 Event	145	4091	16529	INT	R/W	0 = Low Alarm 1 = High Alarm
Alarm 4 Setpoint 2 Event	147	4093	16531	INT	R/W	0 = Low Alarm 1 = High Alarm
Alarm 1 Hysteresis	11	400B	16395	FP	R/W	0.0 to 100% of output or span
Alarm 2 Hysteresis	12	400C	16396	FP	R/W	0.0 to 100% of output or span
Alarm 3 Hysteresis	13	400D	16397	FP	R/W	0.0 to 100% of output or span
Alarm 4 Hysteresis	14	400E	16398	FP	R/W	0.0 to 100% of output or span
Alarm 1 Latching	200	00C8	200	INT	R/W	0 = Non Latching 1 = Latching

Parameter		Register Address		Data Type	Access	Data Range or Enumerated Selection
Description	ID	Hex	Decimal			
Alarm 2 Latching	228	00E4	228	INT	R/W	0 = Non Latching 1 = Latching
Alarm 3 Latching	229	00E5	229	INT	R/W	0 = Non Latching 1 = Latching
Alarm 4 Latching	230	00E6	230	INT	R/W	0 = Non Latching 1 = Latching
Alarm 1 and 2 States (Read Only)	201	00C9	201	INT	R	State = 0 = Not in Alarm State = 1 = In Alarm Bit 0 = Alarm 1 SP1 State Bit 1 = Alarm 1 SP2 State Bit 2 = Alarm 2 SP1 State Bit 3 = Alarm 2 SP2 State Event = 0 = Low Event = 1 = High Bit 4 = Alarm 1 SP1 Event Bit 5 = Alarm 1 SP2 Event Bit 6 = Alarm 2 SP1 Event Bit 7 = Alarm 2 SP2 Event
Alarm 3 and 4 States (Read Only)	248	00F8	248	INT	R	Event = 0 = Low Event = 1 = High Bit 0 = Alarm 3 SP1 Event Bit 1 = Alarm 3 SP2 Event Bit 2 = Alarm 4 SP1 Event Bit 3 = Alarm 4 SP2 Event State = 0 = Not in Alarm State = 1 = In Alarm Bit 4 = Alarm 3 SP1 State Bit 5 = Alarm 3 SP2 State Bit 6 = Alarm 4 SP1 State Bit 7 = Alarm 4 SP2 State
Alarm Blocking	202	00CA	202	INT	R/W	0 = Disable 1 = Block Alarm 1 2 = Block Alarm 2 3 = Block Alarm 3 4 = Block Alarm 4 5 = Block Alarms 1 and 2 6 = Block Alarms 1,2,3 7 = Block Alarms 1,2,3,4
Diagnostic Alarm	154	009A	154	INT	R/W	0 = Disable 1 = Alarm 1 2 = Alarm 2 3 = Alarm 3 4 = Alarm 4 5 = DISWARN
Alarm Message	239	00EF	239	INT	R/W	0 = Disable 1 = Enable

10.7.22 Maintenance

Table 10-31 lists all the register addresses and ranges or selections for the function parameters in Set-up Group Maintenance.

Table 10-31 Set-up Group – Maintenance

Parameter		Register Address		Data Type	Access	Data Range or Enumerated Selection
Description	ID	Hex	Decimal			
Timer 1	219	00DB	219	INT	R/W	0 = Disable 1 = Last Reset 2 = A1S1 3 = A1S2 4 = A2S1 5 = A2S2 6 = A3S1 7 = A3S2 8 = A4S1 9 = A4S2 10 = Man Loop 1 11 = Guaranteed Soak 12 = Sooting 13 = DI 1 Closed 14 = DI 2 Closed 15 = DI 3 Closed 16 = DI 4 Closed 17 = Man Loop 2
Timer 2	220	00DC	220	INT	R/W	Same as 219
Timer 3	221	00DD	221	INT	R/W	Same as 219

Parameter		Register Address		Data Type	Access	Data Range or Enumerated Selection
Description	ID	Hex	Decimal			
Counter 1	222	00DE	222	INT	R/W	0 = Disable 1 = Man Loop1 2 = A1S1 3 = A1S2 4 = A2S1 5 = A2S2 6 = A3S1 7 = A3S2 8 = A4S1 9 = A4S2 10 = DI 1 Closed 11 = DI 2 Closed 12 = DI 3 Closed 13 = DI 4 Closed 14 = Output 1 Relay X 1K 15 = Output 2 Relay X 1K 16 = Output 3 Relay X 1K 17 = Output 4 Relay X 1K 18 = Output 5 Relay X 1K 19 = Guaranteed Soak 20 = PWR Cycle 21 = PV Range L1 22 = Failsafe L1 23 = Tune L1 24 = Man Loop 2 25 = PV Range Loop 2 26 = Failsafe Loop 2 27 = Tune Loop 2
Counter 2	223	00DF	223	INT	R/W	Same as 222
Counter 3	224	00E0	224	INT	R/W	Same as 222
Healthwatch Maintenance (HWM) Reset ID	48	0030	48	INT	R/W	0 to 9999
Maintenance Reset	227	00E3	227	INT	R/W	0 = None 1 = Timer 1 2 = Timer 2 3 = Timer 3 4 = All Timers 5 = Counter 1 6 = Counter 2 7 = Counter 3 8 = All Counters 9 = All Timers and Counters
HWM Days 1	110	406E	16494	FP	R	Shows elapsed time of Timer 1 in Days. (0 – 9999)

Parameter		Register Address		Data Type	Access	Data Range or Enumerated Selection
Description	ID	Hex	Decimal			
HWM Hours.Minutes 1	111	406F	16495	FP	R	Shows elapsed time of Timer 1 in Hours and Minutes. (00.00 – 23.59)
HWM Days 2	112	4070	16496	FP	R	Shows elapsed time of Timer 2 in Days. (0 – 9999)
HWM Hours.Minutes 2	113	4071	16497	FP	R	Shows elapsed time of Timer 2 in Hours and Minutes. (00.00 – 23.59)
HWM Days 3	114	4072	16498	FP	R	Shows elapsed time of Timer 3 in Days. (0 – 9999)
HWM Hours.Minutes 3	115	4073	16499	FP	R	Shows elapsed time of Timer 3 in Hours and Minutes. (00.00 – 23.59)
HWM Counter 1	116	4074	16500	FP	R	Shows the value of Counter 1. 0-9999 (1 = 1000 counts for output relays 1 to 5)
HWM Counter 2	117	4075	16501	FP	R	Shows the value of Counter 2. 0-9999 (1 = 1000 counts for output relays 1 to 5)
HWM Counter 3	118	4076	16502	FP	R	Shows the value of Counter 3. 0-9999 (1 = 1000 counts for output relays 1 to 5)

10.7.23 Time Event

Table 10-32 lists all the register addresses and ranges or selections for the function parameters in Set-up Group Time Event.

Table 10-32 Set-up Group – Time Event

Parameter		Register Address		Data Type	Access	Data Range or Enumerated Selection
Description	ID	Hex	Decimal			
Time Event 1	184	40B8	16568	INT	R/W	0 = None 1 = Alarm 1 SP2 2 = Alarm 2 SP2 3 = Alarm 3 SP2 4 = Alarm 4 SP2 5 = STrSP/R 6 = Timer 7 = Auto 8 = MAN FS 9 = Use SP1 10 = Use SP2
Time Event 1 Calendar Type	185	40B9	16569	INT	R/W	0 = 5 Day Week 1 = 7 Day Week 2 = Day of Week 3 = Calendar
Time Event 1 Hour	97	4061	16481	FP	R/W	0 to 23
Time Event 1 Minutes	98	4062	16482	FP	R/W	0 to 59
Time Event 1 Month	186	40BA	16570	INT	R/W	0 = Unused 1 = January 2 = February 3 = March 4 = April 5 = May 6 = June 7 = July 8 = August 9 = September 10 = October 11 = November 12 = December
Time Event 1 Days	99	4063	16483	FP	R/W	1 to 31

Parameter		Register Address		Data Type	Access	Data Range or Enumerated Selection
Time Event 2	187	40BB	16571	INT	R/W	0 = None 1 = Alarm 1 SP2 2 = Alarm 2 SP2 3 = Alarm 3 SP2 4 = Alarm 4 SP2 5 = STrSP/R 6 = Timer 7 = Auto 8 = MAN FS 9 = Use SP1 10 = Use SP2
Time Event 2 Calendar Type	188	40BC	16572	INT	R/W	0 = 5 Day Week 1 = 7 Day Week 2 = Day of Week 3 = Calendar
Time Event 2 Hour	106	406A	16490	FP	R/W	0 to 23
Time Event 2 Minutes	107	406B	16491	FP	R/W	0 to 59
Time Event 2 Month	189	40BD	16573	INT	R/W	0 = Unused 1 = January 2 = February 3 = March 4 = April 5 = May 6 = June 7 = July 8 = August 9 = September 10 = October 11 = November 12 = December
Time Event Days	108	406C	16492	FP	R/W	1 to 31

10.7.24 Display

Table 10-33 lists all the register addresses and ranges or selections for the function parameters in Set-up Group Display.

Table 10-33 Set-up Group – Display

Parameter		Register Address		Data Type	Access	Data Range or Enumerated Selection
Description	ID	Hex	Decimal			
Decimal Point Location	155	009B	155	INT	R/W	0 = None – Fixed 1 = One – Floating decimal point to one 2 = Two – Floating decimal point to two 3 = Three – Floating decimal point to three
Decimal Point Location Loop2	155	019B	411	INT	R/W	0 = None – Fixed 1 = One – Floating decimal point to one 2 = Two – Floating decimal point to two 3 = Three – Floating decimal point to three
Temperature Units	129	0081	129	INT	R/W	0 = °F 1 = °C 2 = None
Power Frequency	166	00A6	166	INT	R/W	0 = 60 Hertz 1 = 50 Hertz
Ratio Input 2 from Front Panel	208	00D0	208	INT	R/W	0 = Disable 1 = Enable
Language (Displays)	192	00C0	192	INT	R/W	0 = English 1 = French 2 = German 3 = Spanish 4 = Italian
TC Diagnostics	159	009F	159	INT	R/W	0 = Enable 1 = Disable
Unit ID Number*	41	0029	41	INT	R/W	0 to 255

* The Unit ID Number parameter can be used to uniquely identify a particular instrument.

10.7.25 Clock

Table 10-34 lists all the register addresses and ranges or selections for the function parameters in Set-up Group Clock.

Table 10-34 Set-up Group – Clock

Parameter		Register Address		Data Type	Access	Data Range or Enumerated Selection
Description	ID	Hex	Decimal			
Clock Hours	16	4010	16400	FP	R/W	0 to 23
Clock Minutes	17	4011	16401	FP	R/W	0 to 59
Clock Seconds	18	4012	16402	FP	R/W	0 to 59
Clock Month	137	4089	16521	INT	R/W	0 = Unused 1 = January 2 = February 3 = March 4 = April 5 = May 6 = June 7 = July 8 = August 9 = September 10 = October 11 = November 12 = December
Clock Day	19	4013	16403	FP	R/W	1 to 31
Clock Year	20	4014	16404	FP	R/W	2005 to 2099
Time Zone (GMT)	21	4015	16405	FP	R/W	-1200 to +1300 (hours and minutes away from GMT)

Note: The Time Zone setting is used only for Email purposes, it has no other function.

10.8 Modbus RTU Exception Codes

Introduction

When a master device sends a query to a slave device it expects a normal response. One of four possible events can occur from the master's query:

- *Slave device receives the query without a communication error and can handle the query normally.*
It returns a normal response.
- *Slave does not receive the query due to a communication error.*
No response is returned. The master program will eventually process a time-out condition for the query.
- *Slave receives the query but detects a communication error (parity, LRC or CRC).*
No response is returned. The master program will eventually process a time-out condition for the query.
- *Slave receives the query without a communication error but cannot handle it (i.e., request is to a non-existent coil or register).*
The slave will return with an exception response informing the master of the nature of the error (Illegal Data Address.)

The exception response message has two fields that differentiate it from a normal response:

Function Code Field:

In a normal response, the slave echoes the function code of the original query in the function code field of the response. All function codes have a most-significant bit (MSB) of 0 (their values are below 80 hex). In an exception response, the slave sets the MSB of the function code to 1. This makes the function code value in an exception response exactly 80 hex higher than the value would be for a normal response.

With the function code's MSB set, the master's application program can recognize the exception response and can examine the data field for the exception code.

Data Field:

In a normal response, the slave may return data or statistics in the data field. In an exception response, the slave returns an exception code in the data field. This defines the slave condition that caused the exception.

Query

Example: Internal slave error reading 2 registers starting at address 1820h from slave at slave address 02.
02 03 18 20 00 02 CRC CRC

Response

Example: Return MSB in Function Code byte set with Slave Device Failure (04) in the data field.
02 83 04 CRC CRC

Table 10-35 Modbus RTU Data Layer Status Exception Codes

Exception Code	Definition	Description
01	Illegal Function	The message received is not an allowable action for the addressed device.
02	Illegal Data Address	The address referenced in the function-dependent data section of the message is not valid in the addressed device.
03	Illegal Data Value	The value referenced at the addressed device location is no within range.
04	Slave Device Failure	The addressed device has not been able to process a valid message due to a bad device state.
06	Slave Device Busy	The addressed device has ejected a message due to a busy state. Retry later.
07	NAK, Negative Acknowledge	The addressed device cannot process the current message. Issue a PROGRAM POLL to obtain device-dependent error data.
09	Buffer Overflow	The data to be returned for the requested number of registers is greater than the available buffer space. <i>Function Code 20 only.</i>

11 Further information

11.1 Modbus RTU Serial Communications

Refer to Honeywell document 51-52-25-66 Modbus RTU Serial Communications User Manual.

11.2 Modbus Messaging on Ethernet TCP/IP

Refer to Honeywell document 51-52-25-121 MODBUS Messaging on Ethernet TCP/IP Implementation Guide.

11.3 How to Apply Digital Instrumentation in Severe Electrical Noise Environments

Refer to Honeywell document 51-52-05-01 How to Apply Digital Instrumentation in Severe Electrical Noise Environments.

12 Index

- 8 Segment Characterizers3, 216
- A**
- Aborting Accutune212
- Accutune – Register Addresses383
- Accutune Error Codes211
- Accutune III5, 204
- Accutune Set Up Group72
- Alarm Blocking171
- Alarm Hysteresis168
- Alarm Outputs15
- Alarm Prompts For Healthwatch Option166
- Alarm Prompts For Two Loops/Cascade Option
.....165
- Alarm Relay Output Failure323
- Alarm Relays19
- Alarm Setpoints234
- Alarm Setpoints Display234
- Alarms3
- Alarms – Register Addresses421
- Alarms For Software Options165
- Alarms Set Up Group164
- Algorithm – Register Addresses385
- Algorithm Set Up Group77
- Ambient Temperature16
- Analog Input Failure325
- Analog Input Signal Failure Operation13
- Analog Inputs2, 13
- Annunciators196
- Application Related Problems306
- Approval Body Options5
- Atmospheric Pressure Compensation86
- Auto Bias145
- Auto/Manual Key195
- Auto/Manual Station4
- Auto/Manual Station Mode224
- Automatic Cascade200
- Automatic Tune208
- Automatic With Local Setpoint200
- Automatic With Remote Setpoint200
- Autotune Is Complete212
- Auxiliary Output4
- Auxiliary Output Range152
- B**
- Background Tests309
- Baud Rate161
- Bias118, 121, 124, 127, 130
- Blended Tune209
- Burnout Protection118, 122, 125, 127, 130
- C**
- Calibration Mode291, 303
- Calibration Steps276
- Carbon Potential86, 240, 241
- Carbon Potential192, 238
- Carbon Potential Selections83
- Cascade Control228
- CE Conformity (Europe)10
- CE Mark5
- Changing Control Modes201
- Changing The Local Setpoints202
- Characterizer92, 94
- Clock – Register Addresses431
- Combinational Inputs3
- Communications4
- Communications – Register Addresses419
- Communications Failure326
- Communications Selection160
- Communications Set Up Group160
- Comparator Gates217
- Computer Setpoint353
- Computer Setpoint Bias162
- Computer Setpoint Ratio162
- Computer Setpoint Units162
- Configuration43
- Configuration Data345
- Configuration Parameters356
- Configuration Procedure49
- Configuration Prompt Hierarchy45
- Configuration Record Sheet184
- Control – Register Addresses409
- Control 2 Set Up Group141
- Control Algorithm77
- Control And Alarm Relay Contact Information19
- Control Loop 2 – Register Addresses412
- Control Mode Definitions200
- Control Modes200
- Control Relays19
- Control Set Up Group132
- Control/Alarm Circuit Wiring22
- Controller Dropoff Value138, 147
- Controller Failure Symptoms314
- Controller Grounding22
- Controller Output Types14
- Counter174
- Current Duplex106, 109
- Current Output34, 36, 111
- Current Output 2148
- Current Output 3152
- Current Output Calibration294, 296, 298
- Current Output Failure Symptoms316
- Current Simplex106, 109
- Current/Time Duplex106, 109
- Current/Time Or Time/Current Proportional
Output Failure322
- Customer Support307
- Cycle Number350
- Cycle Time (Cool)52, 56
- Cycle Time (Heat)52, 56
- Cycles Remaining350

D

Data Security	5
Data Transfer	345
Deadband	138, 147
Decimal Point Location	176
Declaration Of Conformity	10
Demand Tuning	72
Dewpoint	84, 192, 238
Diagnostic	171
Diagnostic Alarm	171
Diagnostic Messages	198
Diagnostic/Failsafe Outputs	5
Digital Input (Remote) Operation	258
Digital Input Combinations	158
Digital Input Option	219
Digital Input Prompts For Multiple Set Point Programs	158
Digital Input Selections	153
Digital Inputs	3, 13
Digital Inputs Option Connections	40
Digital Output Status	108, 111
Dimensions	20
Direct Acting Control	137, 146
Display – Register Addresses	430
Display Indicators	7
Display Set Up Group	176
Dual Relay Output For Time Duplex	37

E

Eight Segment Characterizer	92, 94
Elapsed Time	203
Electrical Considerations	22
Electrical Noise Precautions	22
Electromechanical Relay Output	35, 41
Email Configuration Screen	182
EMC Classification	10
Emissivity	119, 122, 125
Enclosure Rating	10
End Segment Number	245
Environmental And Operating Conditions	16
Equipment You Will Need To Calibrate	278
Error Codes	211
Error Messages	198
Estimated Motor Position	236
Ethernet	8
Ethernet Communications Address	272
Ethernet Communications Failure	328, 329
Ethernet Communications Option With Adaptor Board	38
Ethernet Communications Option Without Adaptor Board	39
Ethernet Configuration Screen	181
Ethernet Connection	269
Ethernet Status	264
Ethernet TCP/IP Communications Interface	15
Ethernet TCP/IP Protocol	160
External Interface Option Connections	40
External Setpoint Program Reset	155
External Wiring	23

F

Factory Calibration	291, 303
Failsafe Function Prompt	237, 238
Failsafe Manual Mode	308
Failsafe Mode	139, 147
Failsafe Mode	238
Failsafe Output Value	139, 147
Failsafe Output Value	237
Failsafe Output Value For Restart After A Power Loss	237
Failure Modes	5
Fast Tune	5
Feedforward Multiplier	82
Feedforward Multiplier	2
Feedforward Summer	82
Feedforward Summer	2
Field Wiring	278
Filter	118, 121, 124, 127, 130
First Current Output Calibration Procedure	295
Flow Totalizer	216
Frequency (Hz)	16
Function Code 20	338
Function Code 21	342
Function Codes 20 And 21	336
Function Prompts	45
Fuzzy Logic	6
Fuzzy Overshoot Suppression	72, 212

G

Gain	50, 54
Gain 2	51, 52, 55, 56
Guaranteed Soak	247

H

Healthwatch	4, 241
Healthwatch Data	265
Healthwatch Data - Reset	266
Healthwatch Timers And Counters	178
Heat/Cool (Duplex Tune)	6
High Scaling Factor	85
High Select	82
Hlai Inputs 2 And 4 Connections	32
Hlai Inputs 3 And 5 Connections	33
Hot Start	61, 64, 66, 70, 246
Hydrogen Content	86
Hysteresis (Output Relay)	139

I

Identification Number	177
Infrared	8
Infrared Communications	9
Infrared Communications	15
Input 1 – Register Addresses	399
Input 1 Actuation Type	116
Input 1 Calibration Procedure	289
Input 1 Connections	29
Input 1 High Range Value	117
Input 1 Low Range Value	118, 121
Input 1 Set Up Group	116
Input 2 – Register Addresses	401
Input 2 Connections	30
Input 2 Set Up Group	120
Input 3 – Register Addresses	403

Input 3 Actuation Type	123	Manual Cascade	200
Input 3 Connections	31	Manual Latching	157
Input 3 Set Up Group	123	Manual Reset	51, 55
Input 4 – Register Addresses	405	Manual Tune	210
Input 4 Actuation Type	126	Mass Flow Example	90
Input 4 Set Up Group	126	Mass Flow Orifice Constant (K) For Math Selections.....	85
Input 5	407	Math – Register Addresses	390
Input 5 Actuation Type	129	Math Functions.....	2
Input 5 Set Up Group	129	Math Set Up Group	92
Input Algorithm Selections	215	Mechanical Shock	16
Input Calibration.....	275	Minimum And Maximum Range Values	276
Input High/Low Select	2	Modbus	160
Input Math Algorithms	215	Modbus Read, Write And Override Parameters	345
Input Wiring Terminals	278	Modbus RTU Exception Codes	432
Installation	11	Modbus RTU Function Codes	336
Installation Category	10	Model Number Interpretation.....	17
Installation Related Problems	306	Moisture Protection	5
Integration Rates.....	216	Monitoring And Operating The Controller.....	192
Internal Cascade Control:	229	Monitoring Two-Loop Control	232
IR Communications Port	160	Motor Position Display.....	236
Isolation.....	15	Motor Time	300
J		Motor Time	108
Jumper Positions	33	Mounting	20
K		Mounting Method	21
Key Error	195	Mounting Procedure	21
Key Lockout	195	Multiplier.....	83
Key Lockout	53	Multiplier Divider.....	83
Keyboard Failure.....	324	Multiplier Divider With Square Root	83
Keys And Functions	7	Multiplier With Square Root.....	83
L		Multiplier/Divider.....	2
Latching	238	N	
Line Voltage Wiring	22	Noise Immunity	5
Local Area Network (Lan) Settings.....	271	Non-Latching.....	238
Local Setpoint Source	135, 144	O	
Lockout	53	On/Off Algorithm	77
Lockout Feature	194	Open Collector Output	36
Lockout Levels	194	Operating Parameters	197
Logic – Register Addresses	393	Operation Of Two-Loop Control	233
Logic Gate Function	217	Operator Interface	6, 193
Logic Gates	3	Option Status	349
Logic Gates Constraints.....	217	Options – Register Addresses.....	415
Logic Gates Set Up Group.....	98	Options Set Up Group	148
Loop 2 Output Functionality And Restrictions	26	Output 2 Options	14
Loop Break.....	165	Output Algorithm	105, 108
Loop Data – Alarm Details	260	Output Algorithms – Register Addresses	397
Loop Data – Digital Input Details.....	261	Output Calibration	293
Loop Data Screen	259	Output Change Rate	138, 146
Loopback Test	163	Output Override.....	233
Low Fire	157	Output Override (2 Pid Loops Only)	198
Low Scaling Factor.....	85	Output Rate Down Value.....	138, 146
Low Select	83	Output Rate Limiter	5
Lower Display Key Parameter Prompts.....	197	Output Rate Up Value	138, 146
M		Output Set Up Group	105
Mains Power Supply	22, 28	Output Types.....	3
Maintenance		Overriding Controller Setpoint	353
Counters	173	Oxygen.....	84, 192, 238
Timers	173		
Maintenance – Register Addresses	425		
Maintenance Set Up Group.....	173		
Manual	200		

P,Q

P.I.E. Tool	269
P.I.E. Tool Ethernet And Email Configuration Screens	181
P.I.E. Tool Maintenance Screens	259
Parts Identification	334
Parts List	333
Password	175
Pd With Manual Reset	78
Permissible Wiring Bundling	23
Physical Considerations	20
PID A	78
PID B	78
Pollution Degree	10
Polynomial Curve Characterizer	3
Polynomial Equation	96
Position Proportional Connections	11, 37
Position Proportional Control	300
Position Proportional Output Failure	318
Position Proportional Simplex	106
Power Consumption	15
Power Failure Symptoms	316
Power Inrush Current	15
Power Line Frequency	177
Power Outage	258
Power Outage	243
Power Outages	242
Power-Up Tests	308
Pre-Installation Information	13
Process Instrument Explorer	8
Program Contents	245
Program Record Sheet – Program #1	249
Program Record Sheet – Program #2	251
Program Record Sheet – Program #3	253
Program Record Sheet – Program #4	255
Program State	245
Program Termination State	245
Proportional Band	50, 54
Proportional Band 2	51, 52, 55, 56
Proportional Band Units	139
Purge	157
PV Hot Start	242
PV Tuning	72
R	
Ramp Time Or Rate Segments	246
Ramp/Soak Profile Example	248
Rate	50, 54
Rate 2	51, 52, 55, 56
Rate Down Value	59
Rate Up Value	59
Ratio	118, 121, 124, 127, 130
Read Maintenance Set Up Group	178
Read Onlys	350
Read Software Options Status	349
Reading Control Data	348
Real Time Clock	4, 268
Real Time Clock Set Up Group	172
Recycle Number	245
Register Address Structure	337
Register Count	337
Relative Humidity	82, 86

Relative Humidity	16
Remote Setpoint Source	144
Remote Switching	219
Removing The Chassis	335
Rerun Current Segment	246
Reset	51, 55
Reset 2	51, 52, 55, 56
Reset Program To Beginning	245
Reset Totalizer	157
Reset Totalizer Value	221
Reset Type	175
Reset Units	140
Restore Factory Calibration	291
Restore Factory Output Calibration	303
Restoring Factory Configuration	330
Reverse Acting Control	137, 146
RS 485	8
RS-422/485 Communications Option Connections	38
RS422/485 Modbus Rtu Communications Interface	15
RS-485 And Ethernet Transaction Rates	15
RTD Inputs	282
Run/Hold Key	195
Run/Hold Key	242
Run/Monitor The Program	257
S	
Second Current Output Calibration Procedure	297
Second Current Output Range	152
Security	5
Security Code	52, 193
Segment Time Remaining In Hours	350
Set Point Select Function Key	195
Set Up Group	45
Set Up Wiring Procedure For Auxiliary Output	296
Set Up Wiring Procedure For Third Current Output	298
Setpoint Code Selections	351
Setpoint High Limit	137, 146
Setpoint Low Limit	137, 146
Setpoint Program Event Alarms	258
Setpoint Program Number	197
Setpoint Program Read Only	350
Setpoint Program Selection	158
Setpoint Programming Event Alarms	235
Setpoint Programming-Enhanced	5
Setpoint Ramp	58
Setpoint Ramp	242
Setpoint Ramp Final Setpoint	58
Setpoint Ramp Time	58
Setpoint Ramp/Soak Programming	5, 244
Setpoint Rate	58
Setpoint Rate	5, 242
Setpoint Tracking	145
Setpoints	4, 201, 351
Shed Time	161
Shed Timer Reset	354
Slowtune	5
Soak Segments	247
Software Type	350
Software Upgrade Part Number	332
Software Upgrades	331, 335

Software Version	350
Software Version Number	307
Solid State Relay Output	35
SP Ramp Set Up Group	57, 63, 66, 69
SP Ramp/Rate/Program#1 – Register Addresses	359
SP Ramp/Rate/Program#2 – Register Addresses	365
SP Ramp/Rate/Program#3 – Register Addresses	371
SP Ramp/Rate/Program#4 – Register Addresses	377
SP Tuning	72
Specifications	13
Start Segment Number	245
Start Up Procedure For Operation	199
Status Data	262
Status Data – Diagnostics History	263
Status Tests	308
Stray Rejection	13
Summer With Ratio And Bias	82
Summer/Subtractor	2
Suppression Devices	23
Switch Between Two Sets Via Keyboard	214
Switching Between Setpoints	202
Switchover Value	144
T	
Temperature Units	176
Test Failures	308
Thermocouple Diagnostic Messages	177
Thermocouple Health	2
Thermocouple Inputs Using A Thermocouple Source	281
Thermocouple Inputs Using An Ice Bath	280
Third Current Output Calibration Procedure	299
Third Current Output Range	152
Three Position Control Step Output Start-Up Mode	137
Three Position Step	79
Three Position Step Control	37, 300
Three Position Step Control Algorithm	236
Three Position Step Test Failures	308
Three Relay Board	14
Time Current Duplex	106, 109
Time Duplex	106, 109
Time Event – Register Addresses	428
Time Events Set Up Group	179
Time Proportional Output	105, 106, 109
Time Proportional Output Failure	321
Time Remaining	203
Time Simplex	105, 109
Time-Out	203
Timer	4, 80, 173, 203
Totalizer	3
Totalizer Data	267
Totalizer Displays	216
Totalizer Function	80, 95
Totalizer Reset Via Digital Input	217
Transmitter Characterization	117, 121, 124, 126, 129
Transmitter Power	4
Transmitter Power For 4-20 Ma	11, 41, 42
Troubleshooting Aids	306
Troubleshooting Procedures	315
Troubleshooting/Service	305
Tune	205
Tune For Duplex (Heat/Cool)	207
Tune For Simplex Outputs	206
Tuning	50, 54
Tuning Constants	5
Tuning Indicators	204
Tuning Loop 1 – Register Addresses	356
Tuning Loop 2 – Register Addresses	358
Tuning Parameter Sets	132
Tuning Parameter Sets—Loop 2	141
Tuning Set Up Group	50, 54
Two Loops Of Control	228
Two Sets Of Tuning Constants	213
TX Delay	161
U	
Universal Output Functionality And Restrictions	24, 25
Universal Switching Power	4
V	
Vibration	16
Voltage And Resistance Equivalents For 0% And 100% Range Values	276
W, X, Y, Z	
Weight	15
Weighted Average	2
Weighted Average Ratio	85
Wiring	22
Wiring Bundling	23
Wiring Connections For Calibrating The First Current Output	294
Wiring Connections For Calibrating The Second Current Output	296
Wiring Connections For Calibrating Third Current Output	298
Wiring Connections For Dual High Level Milliampere Inputs	288
Wiring Connections For Radiamatic, Milliampere, Millivolts, Or Volts (Except 0 To 10 Volts)	283, 286, 287
Wiring Connections For RTD (Resistance Thermometer Device)	282
Wiring Diagrams	24
Wiring The Controller	27
Worksheet	244
WS Float	161

13 Sales and Service

Sales and Service

For application assistance, current specifications, pricing, or name of the nearest Authorized Distributor, contact one of the offices below.

ASIA PACIFIC

Australia

Honeywell Limited
231 Riverside Drive West End
Brisbane QLD 4101
Phone: (61) 7-3846 1255
FAX: (61) 7-3840-6481
Email: peter.rutch@honeywell.com

China – PRC – Beijing

Honeywell (China) Ltd - Beijing
17B/F, Eagle Plaza,
No.26 XiaoYun Road,
ChaoYang District,
Beijing 100016
P.R.China
Phone: (86-10) 8458-3280
Fax: (86-10) 8458-4650
Email: jrn.gui.wang@honeywell.com

China – PRC – Shanghai

Honeywell (China) Ltd - Shanghai
33F., Tower A, City Center
100 Zun Yi Road,
Shanghai 200051,
P.R.China
Phone: (86-21) 5257-4568
Fax: (86-21) 6237-2826
Email: hui.dong.zhang@honeywell.com

China – PRC – Chengdu

Honeywell (China) Ltd - Chengdu
Room 2301, Zong Fu Mansion
Chengdu 610016
Phone: (86-28) 8678-6348
Fax: (86-28) 8678-7061
Email: jason.luo@honeywell.com

China – PRC – Xi'an

Honeywell (China) Ltd - Xi'an
Rm 0605A,6 floor,
Hi-Tech Internation Business Center
No.33 Ke Ji Road,Gao Xin
Development Zone
Xi'an 710075, P.R.C
Phone: (86-29) 8833-7490
Fax: (86-29) 8833-7489
Email: jun.liu@honeywell.com

China – PRC – Shenzhen

Honeywell (China) Ltd - Shenzhen
Unit 6-7, 25/F, Tower A
Electronic Tech. Building
2070, Shen Nan Road, Futian
District
Shenzhen 518031, P.R.China
Phone: (86) 755-2518-1226
Fax: (86) 755-2518-1221
Email: robin.tu@honeywell.com

Indonesia

PT Honeywell Indonesia
Sastra Graha, 5th Floor Suite 509
Jl. Raya Perjuangan No. 21
Jakarta 11530
Indonesia
Phone: (62) 21- 535 8833
Fax: (62) 21- 5367 1008
Email: junus.juwana@honeywell.com

India

Honeywell Automation India Limited
56 & 57 Hadapsar Industrial Estate
Pune 411013
India.
Phone: (91) 20-6603-9400
Fax: (91) 20 6603-9600

Email: Bharti.Modi@honeywell.com

Japan

Honeywell Inc
New Pier Takeshiba
Minato-ku
Tokyo 105-0022 Japan
Phone: (81) 3 6730-7150
Fax: (81) 3 6730-7228
Email:
Yoshi.Morikawa@honeywell.com

South Korea

Honeywell Co., Ltd
18F KukJe Center Building
191, Hangangro-2ga
Yongsan-gu, Seoul, 140-702, Korea
Phone: (822) 799-6315
Fax: (822) 792-9015
Email: hyukk.han@honeywell.com

Malaysia

Honeywell Engineering Sdn Bhd
1st Floor, Block B,
No.10, Jalan Bersatu 13/4,
Petaling Jaya 46200,
Selangor Darul Ehsan.
Tel: (603) 7950 4776
Fax: (603) 7958 8922
Email:
Manimaran.Balasubramaniam@
honeywell.com

New Zealand

Honeywell Limited
264 Mt. Eden Road
Mt. Eden Auckland
New Zealand
Phone: (64-9) 623 5202
Fax: (64-9) 623-5060
Email:
blair.robinson@honeywell.com

Philippines

Honeywell Systems (Philippines)
Inc.
2305A, 23rd Floor, Tektile Tower 1
Exchange Road
Ortigas Center
Pasig City 1605
Philippines
Phone: (63-2) 633 2830 - 31 / 636
1661-62
Fax: (63-2) 638 4013
Email:
Manimaran.Balasubramaniam@
honeywell.com

Singapore

Honeywell Pte Ltd
Honeywell Building
No 17, Changi Business Park
Central 1
Singapore 486073
Phone: (65) 6580-3278
Fax: (65) 6445-3033
Email: rachel.ng@honeywell.com

Thailand

Honeywell Systems (Thailand) Ltd.
252/121 25th Floor
Muang Thai-Phatra Office Tower II
Ratchadapisek Road, Huay
Khwang
Bangkok 10320, Thailand
Phone: (662) 693-3099
FAX: (662) 693-3089
Email: kittinan.viriyasavetkul
@honeywell.com

Taiwan R.O.C.

Honeywell Taiwan Ltd.
10F Honeywell Building
168-1 Lien Chen Road
Chung Ho City
Taipei Hsien, Taiwan R.O.C.
Phone: (886-2) 2245-1000
FAX: (886-2) 2245-3241
Email:
Sabrina.Gau@honeywell.com

Asia Pacific Global Technical Support

For Field & Analytical Instruments:
Henry Chew
Tel: +65 6580 3156
Fax: +65 6445-3033
Email:
Henry.ChewYK@Honeywell.com

For Process Instruments:

Krishna, Edla
Phone: (603) 7950 4777
Fax: (603) 7958 8922
Email:
Krishna.edla@honeywell.com

SOUTHEAST ASIA

See **Singapore** for the following countries:

Cambodia
East Timor
Guam
Laos
Myanmar
Pakistan
Vietnam

See **India** for the following countries:

Bangladesh
Nepal
Sri Lanka

EUROPE

Austria

Honeywell Austria GmbH
Phone: +43 (316)400123
FAX: +43 (316)40017

Belgium

Honeywell SA/NV
Phone: +31(0)205656999
FAX: +31(0)165330746

Bulgaria

Honeywell EOOD
Phone: +(359) 2 79 40 27
FAX: +(359) 2 79 40 90

Czech Republic

Honeywell spol. s.r.o.
Phone: +420-54324-5014
FAX: +420-54324-5011

Denmark

Honeywell A/S
Phone: +(45) 39 55 55 55
FAX: +(45) 39 55 55 58

Finland

Honeywell OY
Phone: +358 (3) 2727625
FAX: +358 (3) 2728600

France

Honeywell SA
Phone: +33 (0)1 60198075
FAX: +33 (0)1 60198201

Germany

Honeywell AG
Phone: +49 (69)8064336

FAX: +49 (69)806497336

Hungary

Honeywell Kft.
Phone: +36-1-451 4335
FAX: +36-1-451 4343

Italy

Honeywell S.p.A.
Phone: +39 02 9214 6503
FAX: +39 0292146377

The Netherlands

Honeywell B.V.
Phone: +31(0)205656999
FAX: +31(0)165330746

Norway

Honeywell A/S
Phone: (45) 39 55 55 55

Poland

Honeywell Sp. zo.o
Phone: +48-22-6060900
FAX: +48-22-6060901

Portugal

Honeywell Portugal Lda
Phone: +351 21 424 5000
FAX: +351 21 424 50 99

Romania

Honeywell Bucharest
Phone: 40212110076
FAX: +40 (40212103375)

Russian Federation (RF),

ZAO "Honeywell"
Phone: +(7 095) 796 98 00
FAX: +(7 095) 796 98 93

Slovak Republic

Honeywell s.r.o.
Phone: +421-2-58247 410
FAX: +421-2-58247 415

Spain

Honeywell S.A.
Phone: +34 (0)91313 61 00
FAX: +34 (0)91313 61 30

Sweden

Honeywell AB
Phone: +(46) 8 775 55 00
FAX: +(46) 8 775 56 00

Switzerland

Honeywell AG
Phone: +41 18552448
FAX: +(41) 1 855 24 45

Turkey

Honeywell Turkey A.S.
Phone: +90 216 575 6600
FAX: +90 216 575 6637

Ukraine

Honeywell
Tel: +380-44-201 44 74
Fax: +380-44-201-44-75

United Kingdom

Honeywell Control Systems Ltd.
Phone: +44 (0)1344 655034
FAX: +44 (0) 1344 655554

MIDDLE EAST

Abu Dhabi U A E

Middle East Headquarters
Honeywell Middle East Ltd.

Phone: +971 2 4041220
FAX: +971 2 4432536

Sultanate of Oman

Honeywell & Co Oman LLC
Phone: +968 701397
FAX +968 787351

Saudia Arabia

Honeywell Turki Arabia Limited
Phone: +966-3-341-0140
Fax: +966-3-341-0216

Kuwait

Honeywell Kuwait KSC
Phone: +965 2421327

AFRICA

Mediterranean & African

Distributors

Honeywell SpA
Phone: +39 (02) 250 10 604
FAX: +39 (02) 250 10 659

South Africa (Republic of)

Honeywell Southern Africa
Honeywell S.A. Pty. Ltd.
Phone: +27 11 6958000
FAX +27 118051504

NORTH AMERICA

Canada

Honeywell LTD
Phone: 1-800-737-3360
FAX: 1-800-565-4130

USA

Honeywell Process Solutions,
Phone: 1-800-343-0228
FAX: 1-717-771-8251

LATIN AMERICA

Argentina

Honeywell S.A.I.C.
Phone: +(54-11) 4383-3637
FAX: +(54-11) 4325-6470

Brazil

Honeywell do Brasil & Cia
Phone: +(55-11) 7266-1900
FAX: +(55-11) 7266-1905

Chile

Honeywell Chile, S.A.
Phone: +(56-2) 233-0688
FAX: +(56-2) 231-6679

Mexico

Honeywell S.A. de C.V.
Phone: +(52) 55 5259-1966
FAX: +(52) 55 5570-2985

Puerto Rico

Honeywell Inc.
Phone: +(809) 792-7075
FAX: +(809) 792-0053

Trinidad

Honeywell Inc.
Phone: +(868) 624-3964
FAX: +(868) 624-3969

Venezuela

Honeywell CA
Phone: +(58-2) 238-0211
FAX: +(58-2) 238-3391

Honeywell

Honeywell Process Solutions
Industrial Measurement and Control
512 Virginia Drive
Fort Washington, PA 19034