

Mainbody/System Specification

Model	SYSTEM 6242/6243 (Multi-channel anemomaster)		
Type	Mainbody (1/1 case) MODEL 1550 (1/2 case) MODEL 1560		
Measuring object	Clean airflow at normal pressure & temperature		
Resolution	Air velocity	Air temperature	Relative humidity
	0~9.99m/s ---- 0.01m/s 10.0~25/50m/s ---- 0.1m/s	0.1°C	0.1%RH
Functions	Display ---- MAN: Changeover by UP/DOWN switch to display value at each module AUTO: Automatic changeover at every 2 sec.		
	Measuring mode: Burst mode ---- Transmitting of all data Channel mode ---- Transmitting of data specified		
	Output: Instantaneous mode ---- Output the data at every specified interval of time. Average mode ---- Take an average of the data in specified interval of time.		
	*Display "REMOTE" while transmitting the data/ It dose not display the measuring value. *Repeat frequency: 1~65,535 times *Measuring time intervals: 0.1xT second (T=1~65,535)		
Interface	Print ---- In display mode, print the measuring value which displayed every 2 seconds. In AUTO, print data of every module automatically. In MAN, print at every 2 seconds only indicated module.		
	Data transmission ---- RS-232C (Standard), GP-IB (Option) Cascade connection ---- RS-232C (Option) Baud rate ---- 300, 600, 1200, 4800, 9600, 19200, bps at your choice Printer output ---- Centronics		

Model	5~40°C
Dimensions	MODEL 1550 -- 430(W)x140(H)x500(D)mm MODEL 1560 -- 226(W)x140(H)x350(D)mm
Weight	MODEL 1550 -- Approx. 10kg MODEL 1560 -- Approx. 5kg
Power	AC100~240V 50/60Hz
Accessories	RS-232C cable (1.5M)x1/Printer cable (1.5M)x1 Power cable (1.5M)x1/Operation manual x1/fusex2 (4A)
Option	Blank panel/Probe cable/Rack Installation metal fittings/ RS-232C for cascade connection (with cable 1.5m)

Compression Fitting (for Model 0964-02)

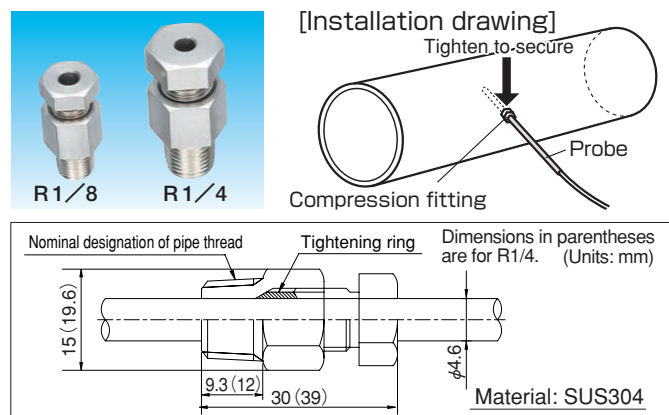

4-channel Anemomaster

SYSTEM 6244 (MODEL 1570)

Four air velocity channels can be measured simultaneously. 10 types of compatible probes can be selected depending on the required application. A wide range of multi-channel measurements can be made, such as air velocity monitoring in cleanrooms and vehicle compartments, air velocity distribution inside ducts, air-conditioner performance checks. (Includes measurement software)



Measuring Software for WINDOWS

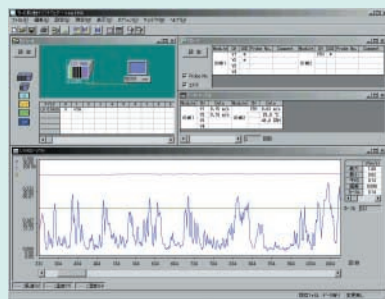

Simultaneously receive data from all channels and display/graph in real time. Measurement data saved as text file for export to standard calculation software such as Excel.

Required System

O S	Windows 95/98/Me/2000/XP
C P U	More than Pentium 50MHz
Memories	Vacancy more than 5MB
H D D	Vacancy more than 10MB
Others	RS-232C must be connected

Specifications contained in this brochure are subject to change for improvement without notice.



To use the units correctly and safely, read the Operation Manual carefully before use.



Kanomax Japan Inc.
2-1 Shimizu, Suita,
Osaka 565-0805, Japan
TEL: +81-6-6877-0183
FAX: +81-6-6877-5570
E-mail: sales@kanomax.co.jp
URL: www.kanomax.co.jp

Kanomax USA, Inc.
P.O.Box 372, 219 Route 206
Andover NJ 07821 U.S.A.
TEL: 1-800-247-8887
FAX: +1-973-786-7586
E-mail: info@kanomax-usa.com
URL: www.kanomax-usa.com

The contents in this catalogue as of August 2007.



CAT.No.E6242-00

MULTI-CHANNEL ANEMOMASTER®

Real-time Air Quality Monitoring System

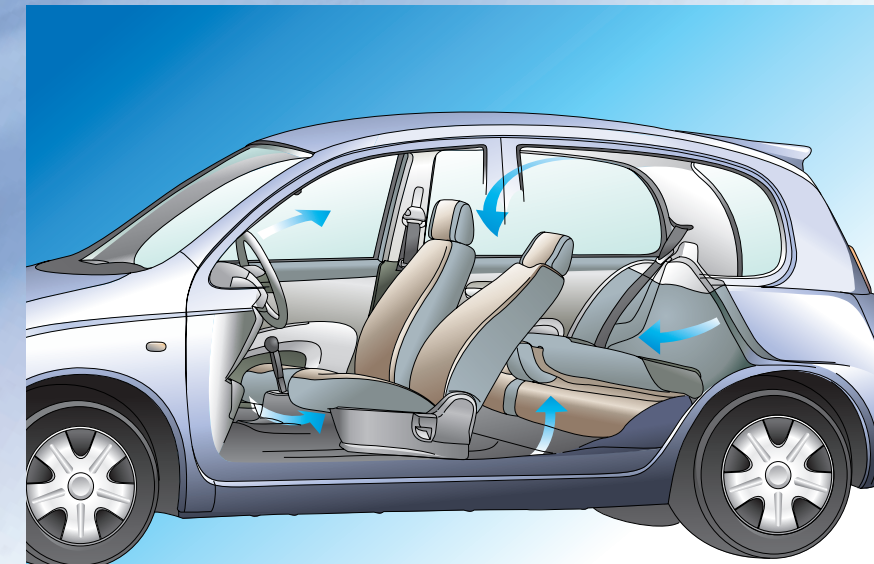

For measuring environments in vehicle compartments

SYSTEM
6242/6243
(MODEL 1550) (MODEL 1560)

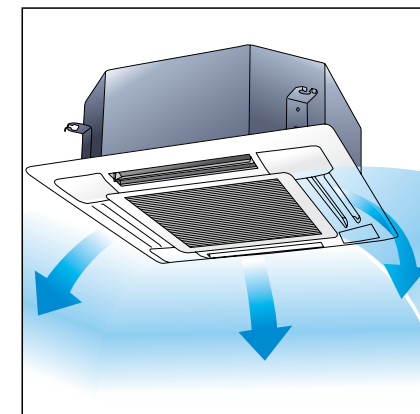

For evaluating performance of air-conditioning equipment

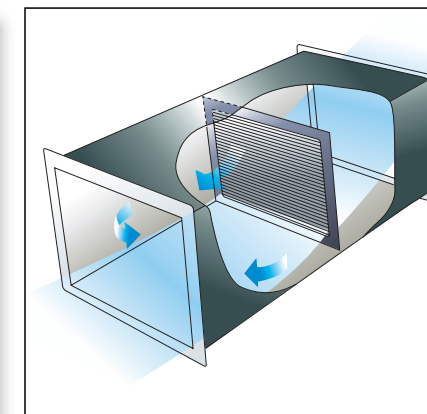

For measuring air velocity distribution inside ducts

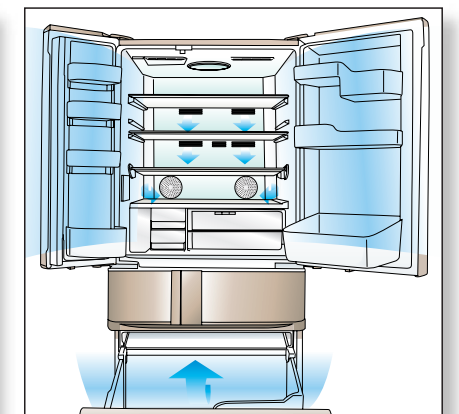

For evaluating performance of cooling & refrigeration equipment

KANOMAX JAPAN INC.



Flexible Multi-channel Configuration. Expandable up to 320 channels.

Real-time monitoring of air velocity, temperature, humidity and pressure measurement

Main body

One unit of Kanomax model 1550 has 64 channels for air velocity. For a larger system, connect up to 5 units in a cascade and add a computer for control. It makes a total of 320 channels. Flexibility in system configuration means greater freedom, simplicity, and efficiency in measurement. *The number of channels is determined by modules to be used.

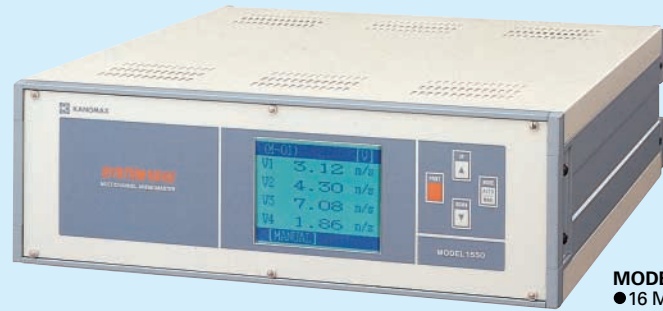

MODEL 1550
●16 Module Slots



MODEL 1560
●6 Module Slots

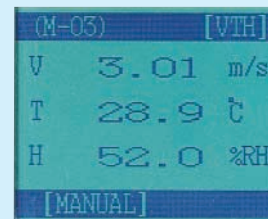
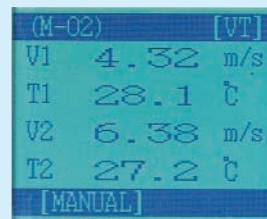
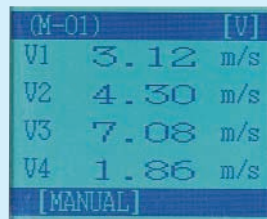

Large Liquid Crystal Display with Backlight shows measurement from each module.

It displays 4 channels simultaneously for the velocity module, 2 for the velocity/temperature module, and 1 for the velocity/temperature humidity module. In Auto mode the display changes every 2 seconds.

Modules

5 kinds of modules provide a wide variety of system configuration.



This system has 5 kinds of modules. By combining each module optionally, you can construct systems freely. Additional innovation and extension after purchase is also available.



MODEL 1504
●V module 4 ch (Air velocity)



MODEL 1511
●VT module 2 ch (Air velocity & Temperature)



MODEL 1512
●VTH module 1 ch (Air velocity & Temperature & Relative Humidity)



MODEL 1503*
●Pressure module 2 ch

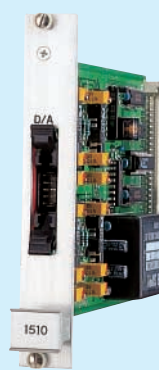

MODEL 1510
●Analog output module

*The actual product may differ slightly from the picture shown.

Ring guard

For MODEL 0965-31 (Probe)

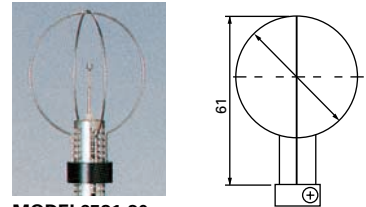

MODEL 6521-30

For MODEL 0965-00, MODEL 0965-21 (Probe)

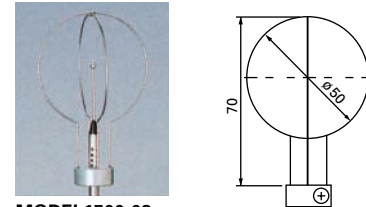

MODEL 1500-03

Rack installation metal fittings



MODEL 1500-04 (2pcs./set)

Option

- GP-IB Connection
- Cascade Connection (RS-232C)
- Others (Please inquire at the nearest office.)

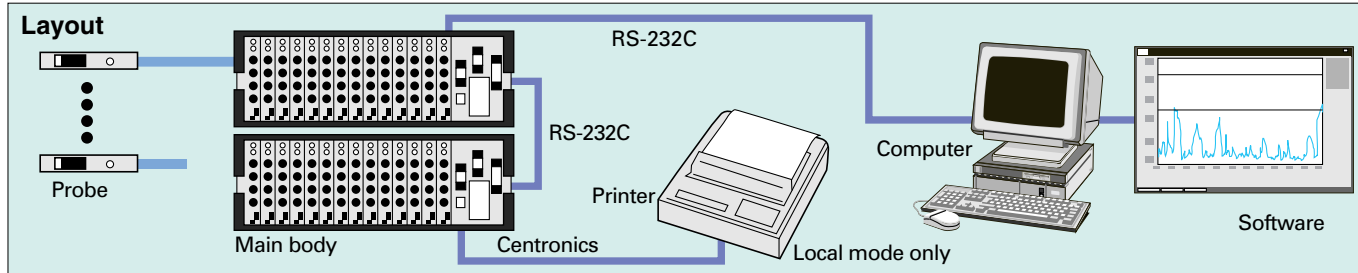

Probe

Select from 11 types of probes. Each probe comes with its own calibration data stored in a ROM to keep interchangeability with other probes and ensure precision. It also eliminates downtime for calibration. Probe cable is extendable (option).

●Air Velocity

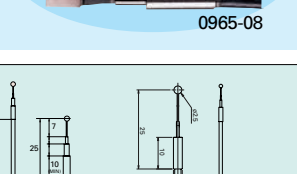
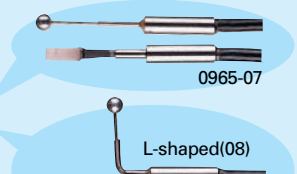
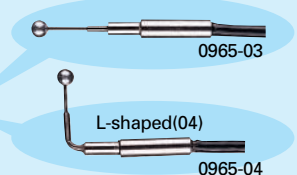
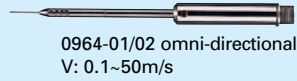
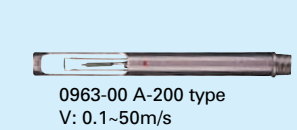
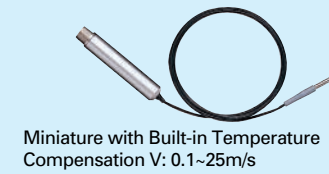
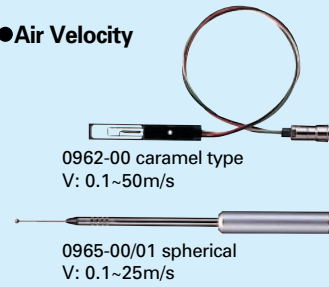

●Air Velocity & Temperature

0962-21 caramel type
V: 0.1~50m/s, T: 0~100°C

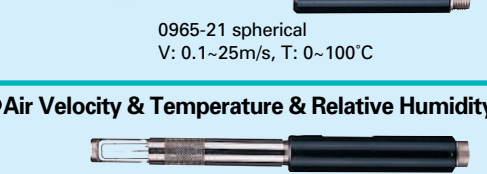
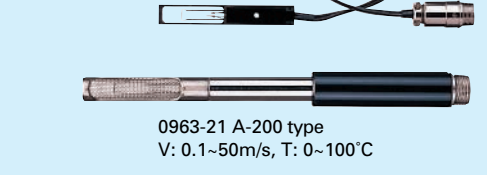

●Air Velocity & Temperature & Relative Humidity

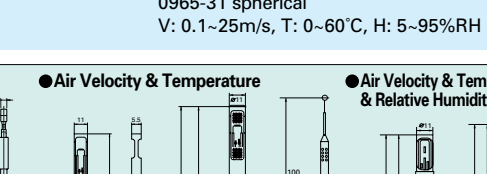

The outline of the probe

●Air Velocity

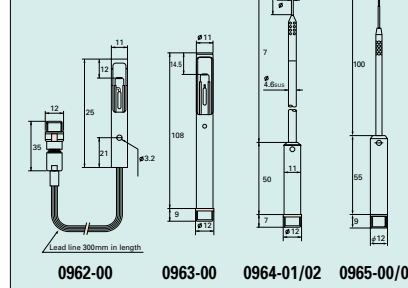

●Air Velocity & Temperature

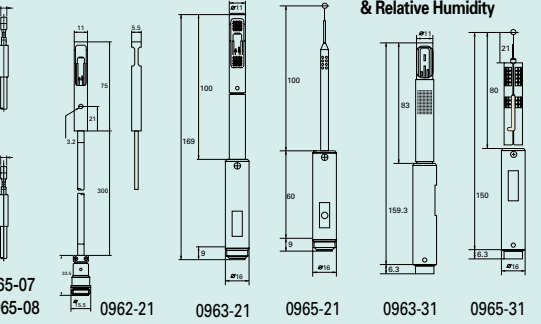

●Probe specifications

Probe (Air velocity)

MODEL	Range	Accuracy
0962-00 0963-00	0.1~4.99m/s	± 0.1 m/s
	5.00~9.99m/s	± 0.2 m/s
	10.0~24.9m/s 25.0~50.0m/s	± 0.5 m/s ± 1.0 m/s
0964-01/02	0.1~4.99m/s	± 0.15m/s
	5.00~9.99m/s	± 0.3 m/s
	10.0~24.9m/s 25.0~50.0m/s	± 0.75m/s ± 1.5 m/s
0965-00/01 03/04/07/08	0.1~4.99m/s	± 0.15m/s
	5.00~9.99m/s	± 0.3 m/s
	10.0~25.0m/s	± 0.60m/s

* Temperature compensation: 5~80°C

Probe (Air Velocity & Temperature)

MODEL	Range	Accuracy	Air Temperature
0965-21	0.1~4.99m/s	± 0.15m/s	Range 0~100°C Accuracy ±1°C
	5.00~9.99m/s	± 0.3 m/s	
	10.0~25.0m/s	± 0.60m/s	
0962-21	0.1~4.99m/s	± 0.1 m/s	Range 0~100°C Accuracy ±1°C
	5.00~9.99m/s	± 0.2 m/s	
	10.0~24.9m/s	± 0.5 m/s	
0963-21	25.0~50.0m/s	± 1.0 m/s	Range 0~100°C Accuracy ±1°C

* Temperature compensation: 5~80°C

Probe (Air Velocity & Temperature & Relative Humidity)

MODEL	Range	Accuracy	
0963-31	Air Velocity	0.1~4.99m/s	± 0.15m/s
		5.00~9.99m/s	± 0.3 m/s
		10.0~24.9m/s 25.0~50.0m/s	± 0.6 m/s
	Air temperature	0~60°C	± 1°C
0965-31	Relative Humidity	5~80%RH	± 3%RH
		80~95%RH	± 5%RH
	Air Velocity	0.1~4.99m/s	± 0.15m/s
0965-31	Air Temperature	0~60°C	± 1°C
		Relative Humidity	5~80%RH
	80~95%RH	± 5%RH	

* Temperature compensation: 5~60°C

Probe cable

MODEL	Length	Module
1504-02 03 04 05 06	2m	1504
	5m	
	10m	
	20m	
	30m	
1511-01 02 03	10m	1511
	20m	
	30m	
1512-01	10m	1512

* Please inquire at the nearest distributor for the length not listed above.

●Pressure Module (MODEL 1503)

Sensor	Dispersed type semi-conductor pressure sensor	
Measuring Range	0~±5kPa	
Measuring Accuracy	Range	Accuracy
	0~1kPa	±0.03kPa
	1~2kPa	±0.03kPa
	2~5kPa	±0.10kPa
* Same to the negative pressure. (minus)		
Operating Temperature	5~40°C	
Resolution	0.01kPa	
Pressure port diameter	φ5	

●Analog Output Module (MODEL 1510)

Number of channels	4 ch
Output Voltage	Standard ... 0~5V
	Option ... ±2.5, ±5V, ±10V, 0~10V
Output Impedance	1 or less Ω
Accuracy	±0.5%FS