

HTPB SERIES

OPERATORS MANUAL



19 Brigham Street • Unit #8 • Marlborough, MA USA 01752
Tel. [508] 263-5900 • [800] 276-3729 • Fax [508] 486-9348
E-mail h2o@edgetech.com • www.edgetech.com

Rev. D May 2009



QUICK STARTUP GUIDE – Page 1

STARTUP

WHEN USING PROBE ONLY:

1. Mount the Probe in position to measure the desired gas.
2. Connect Probe wiring as shown below:

ITEM	COLOR CODE
Power Supply – Pos.	Yellow
Power Supply – Neg.	Green
Output 1 – Pos.	Brown
Output 2 – Pos.	Red
Output 3 – Pos.	Orange
Output Common	Black
Serial Output – TX	Blue
Serial Output – RX	White
Serial Common	Green

Notes:

Connect only the Outputs desired. See the HTPB Manual for details.
Do not apply DC Power until all wiring is completed.

QUICK STARTUP GUIDE – Page 2
WHEN USING PROBE WITH ELECTRONICS UNIT:

1. Mount the Probe and Electronics Unit.
2. Connect cable from Probe to Electronics Unit (if applicable).
3. Connect Power Supply to Electronics Unit.
4. Connect Analog Outputs of Electronics Unit.
5. Connect Digital Output of Electronics Unit.
6. Connect Alarm Relays of Electronics Unit.
7. Connect RS-232 Serial Port of Electronics Unit.

ITEM	CONN.	TERM.
Power Supply (+)	J8	2
Power Supply (-)	J8	1
Analog Out 1 (+)	J9	1
Analog Out 1 (-)	J9	2
Analog Out 2 (+)	J9	3
Analog Out 2 (-)	J9	4
Analog Out 3 (+)	J9	5
Analog Out 3 (-)	J9	6
Alarm Relay 1	J2	1
Alarm Relay 1	J2	2
Alarm Relay 2	J2	3
Alarm Relay 2	J2	4
RS-232 TX	J6	2
RS-232 RX	J6	3
RS-232 RTN	J6	5

Notes:

**Connect only the Outputs desired. See the HTPB Manual for details.
Do not apply DC Power until all wiring is completed.**

TABLE OF CONTENTS	Page
1.0 Quick Startup	2
List of Illustrations	5
List of Tables	5
2.0 EdgeTech's Commitment to Quality	6
3.0 Introduction	7
3.1 General Description	7
3.2 Specifications Summary	8
3.3 Model Descriptions	9
3.4 Available Options	10
4.0 Installation	12
4.1 Mounting the Probe	12
4.2 Mounting the Electronics Unit	13
4.3 Electrical Wiring	13
4.3.1 Probe Only	13
4.3.2 Probe with Electronics	14
5.0 Basic Block Diagram	17
5.1 Probe Assembly	17
5.2 Electronics Module	18
5.3 Complete System	18
6.0 Operation	20
6.1 Initial Bench Testing	20
6.2 Normal Operation	20
6.3 Factory Default Conditions	20
6.4 RS-232 Serial Port	21
6.4.1 Serial Port Setup	21
6.4.2 Changing the Digital Display	22
6.4.3 Changing the Output Ranges	22
6.4.4 Programming the Alarm Relays	23
6.4.5 Calibrating the Analog Outputs	24
7.0 Maintenance	25
7.1 Sensor Circuit Board	25
7.1.1 Replacing the Sensor Board	25
7.1.2 Removing Components	25
7.1.3 Sensor Reassembly	26

8.0 Specifications	27
9.0 Appendix	30
9.1 Warranty Information	31
9.2 Mounting Dimensions	32
9.2.1 Wall Mount	32
9.2.2 Duct Mount	33
9.3 Basic Humidity Definitions	35

LIST OF ILLUSTRATIONS	Page
3-1 Some HTPB Configurations	7
4-1 System with Sample Cell	12
4-2 Installing the Mounting Lugs	13
4-3 Probe Wiring Diagram	14
4-4 Electronics Unit Wiring	16
5-1 Probe Block Diagram	17
5-2 System Block Diagram	19
7-1 Removing Retaining Ring	25
7-2 Sensor Exploded View	26

LIST OF TABLES	Page
3-1 Standard Configurations	9
3-2 Measurement Ranges	11
4-1 Probe Wiring	14
4-2 Electronics Wiring	15
4-3 Serial Port Wiring	15

2.0 EDGETECH'S COMMITMENT TO QUALITY

Thank you for purchasing one of our products. At EdgeTech, it is our policy to provide cost-effective products and support services that meet or exceed your requirements, to deliver them on time, and to continuously look for ways to improve both. We all take great pride in the products we manufacture.

We want you to be entirely satisfied with your instrument. The information contained in this manual will get you started. It tells you what you need to get your equipment up and running, and introduces its many features.

We always enjoy hearing from the people who use our products. Your experience with our products is an invaluable source of information that we can use to continuously improve what we manufacture. We encourage you to contact or visit us to discuss any issues whatsoever that relate to our products or your application.

The Employees of EdgeTech

3.0 INTRODUCTION

3.1 GENERAL DESCRIPTION

The Edgetech HTPB Series is a family of humidity probes and electronic modules that offer a variety of measurement parameters with high accuracy. In addition to Percent Relative Humidity (%RH), probes are available to also measure Temperature and Pressure. Electrical analog and digital outputs are provided for not only these measured parameters, but may be provided for microprocessor- computed parameters as well. These include parts-per-million by volume (ppmv), parts-per-million by weight (ppmw), grains of water per pound of dry gas (gr/lb), and others.

The HTPB system is designed for ease of installation and operation. Field-replaceable sensor modules have standardized outputs for interchangeability without recalibration. The power requirement is a common unregulated DC power supply. User-available electrical outputs include linear analog voltage (or optional current), a digital bi-directional serial port, and alarm relays. Mounting options include Wall Mount, Remote Mount, and Duct Mount configurations. Additional options include high temperature and high pressure probes. A remote or local Display Unit (Type DIS) is available, with a two-line LCD display, alarm relays, and three 4 to 20 mA electrical outputs.

Figure 3-1 Some of the Available HTPB Configurations

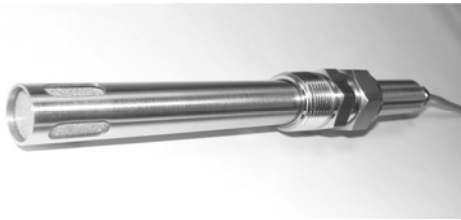

a. Stand-alone Probe



b. Remote Mount with Display Option



c. Wall Mount

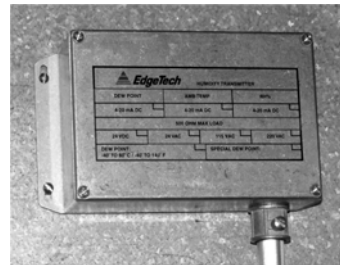

d. Duct Mount

3.2 SPECIFICATIONS SUMMARY

(See Specifications, Chapter 8, for additional information)

3.2.1 STAND-ALONE PROBE

Analog Outputs:	0 – 10 Vdc (X3)
Digital Output:	RS-232C
Power Supply:	18 to 30 Vdc, unregulated, 50 mA max.
RH Accuracy:	+/- 1% nominal
Temp. Accuracy:	+/- 0.5°C
Mounting:	Cable Length: 6 feet
	Fitting: 3/4 inch stainless steel NPT thermocouple fitting
Dimensions:	Length: 8 inches Diameter: 3/4 inch
Materials:	Housing: Stainless Steel Filter: Sintered Stainless Steel (removable)

3.2.2 PROBE WITH ELECTRONICS UNIT

Analog Outputs:	4 to 20 mA (X3)
Digital Output:	RS-232C, bi-directional
Alarm Relays:	Form A (SPST, NO) X2
Power Supply:	18 to 30 Vdc unregulated, 50 mA max.
RH Accuracy:	+/- 1% nominal
Temp. Accuracy:	+/- 0.5°C
Electronics Housing Protection:	IP66 (NEMA 4X) Dust tight and moisture resistant

Table 3-1 HTPB Series, Standard Available Configurations

MODEL NO.	SENSOR ONLY	SENSOR PLUS ELECTRONICS MODULE – WITH DISPLAY
HT60		X
HTB60		X
HT75	X	
HTB75	X	
HTP75	X	
HT75DIS		X
HTB75DIS		X
HTP75DIS		X
HT115		X
HTB 115		X
HTP115		X
HT115N	X	
HTB115N	X	
HTP115N	X	

3.3 HTPB MODEL DESCRIPTIONS

HT60 – Humidity and Temperature probes with Electronics Unit (single unit), providing RH, Dew Point, and Temperature outputs and Digital Display.

HTB60 – Humidity, Temperature, and Barometric Pressure probes with Electronics Unit (single unit), providing RH, Temperature, and Barometric Pressure outputs and Digital Display.

HT75 – A Humidity/Temperature probe providing RH, Dew Point, and Temperature outputs.

HT75DIS – Same as above with Electronics Unit including Digital Display.

HTB75 – A Humidity/Temperature/Barometric Pressure probe providing RH, Temperature, and Pressure outputs.

HTB75DIS – Same as above with Electronics Unit including Digital Display.

HTP75 – A Humidity/Temperature/High Pressure probe providing RH, Temperature, and Pressure outputs.

HTP75DIS – Same as above with Electronics Unit including Digital Display.

HT115 – A Humidity/ High Temperature probe providing RH, Temperature, and Dew Point outputs, with remote Electronics Unit including Digital Display.

HT115N – Identical to HT115, but Probe only without Electronics Unit.

HTB115 – A Humidity/High Temperature/Barometric Pressure probe providing RH, Temperature, and Pressure outputs, with remote Electronics Unit including Digital Display.

HTB115N – Identical to HTB115, but Probe only without Electronics Unit.

HTP115 – A Humidity/High Temperature/High Pressure probe providing RH, Temperature, and Pressure outputs.

HTP115N – Identical to HTB115, but Probe only without Electronics Unit.

3.4 AVAILABLE OPTIONS

-DIS – Remote electronics module with two-line LCD digital display, three 4 to 20 mA analog outputs, RS-232C, and two programmable alarm relays. This unit can be added to existing Probes in the field.

-FRSHT – Field-replaceable sensor module for RH/Temperature/Dew Point. Interchangeability accurate to published specification.

-FRSHTP – Field-replaceable sensor module for RH/Temperature/Pressure. Interchangeability accurate to published specification.

-FRSHTB – Field-replaceable sensor module for RH/Temperature/Barometric Pressure. Interchangeability accurate to published specification.

-HTSC – Sample chamber with inlet and outlet fittings to accept ¼ tubing.

Table 3-2 HTPB Series Sensor Measurement Ranges

MODEL NO.	OUTPUT 1	OUTPUT 2	OUTPUT 3
HT60	PERCENT RH	AIR TEMP.	DEW POINT
DEFAULT RANGE	0 TO 100%	-40 to +60°C	-40 to +60°C
MAX. LIMITS	0 TO 100%	-40 to +60°C	-40 to +60°C
HTB60	DEW POINT	AIR TEMP.	BAR. PRESSURE
DEFAULT RANGE	-40 to +60°C	-40 to +60°C	900 to 1100 mB
MAX. LIMITS	-40 to +60°C	-40 to +60°C	20 to 1100 mB
HT75	PERCENT RH	AIR TEMP.	DEW POINT
DEFAULT RANGE	0 to 100%	-20 to +80°C	-60 to +40°C
MAX. LIMITS	0 to 100%	-40 to +80°C	-60 to +70°C
HTB75	DEW POINT	AIR TEMP.	BAR. PRESSURE
DEFAULT RANGE	-60 to +40°C	-20 to +80°C	900 to 1100 mB
MAX. LIMITS	-60 to +70°C	-40 to +80°C	20 to 1100 mB
HTP75	DEW POINT	AIR TEMP.	ABS. PRESSURE
DEFAULT RANGE	-76 to +104°F	-4 to + 176°F	0 to 200 psia
MAX. LIMITS	-76 to +158°F	-40 to + 176°F	0 to 200 psia
HT115 and HT115N	PERCENT RH	AIR TEMP.	DEW POINT
DEFAULT RANGE	0 to 100%	-20 to +80°C	-60 to +100°C
MAX. LIMITS	0 to 100%	-40 to + 115°C *	-60 to +100°C
HTB115 and HTB115N	DEW POINT	AIR TEMP.	BAR. PRESSURE
DEFAULT RANGE	-60 to +40°C	-35 to +125°C	920 to 1080 hpa
MAX. LIMITS	-60 to +95°C	-40 to +200°C	0 to 1200 hpa
HTP115 and HTP115N	DEW POINT	AIR TEMP.	ABS. PRESSURE
DEFAULT RANGE	-80 to +80°F	0 to +160°F	0 to 160 psia
MAX. LIMITS	- 80 to +203°F	-40 to +239°F	0 to 225 psia

- NOTES:**
- * SCALED TO +125°C FOR USER CONVENIENCE**
 - THE DEFAULT RANGES ARE FIELD PROGRAMMABLE UP TO THE MAX. LIMITS VIA THE RS-232 PORT.**

4.0 INSTALLATION

4.1 MOUNTING THE PROBE

The Probe includes a stainless steel mounting sleeve, commonly called a thermocouple mount. It has a tapered male $\frac{3}{4}$ -inch NPT pipe thread. The female mating fitting, user-supplied, should be mounted in a gas-tight manner to a flat surface of a duct or chamber wall containing the gas to be measured.

To install the mount and Probe:

1. Separate the two parts of the mounting sleeve.
2. Screw the front portion of the mounting sleeve (the tapered NPT fitting) into the pre-mounted mating fitting. Teflon™ tape may be used for a good seal. Do not over-tighten.
3. Insert the Probe into the rear portion, and screw this part of the mount into the previously mounted front portion, so that the Probe is gripped snugly. Do not over-tighten. As much of the Probe as possible should protrude inside the area to be measured, to avoid possible laminar flow errors.

If the Type HTSC sample chamber is to be used, simply screw it down to any flat surface, and connect $\frac{1}{4}$ inch OD tubing to the inlet and outlet compression fittings.

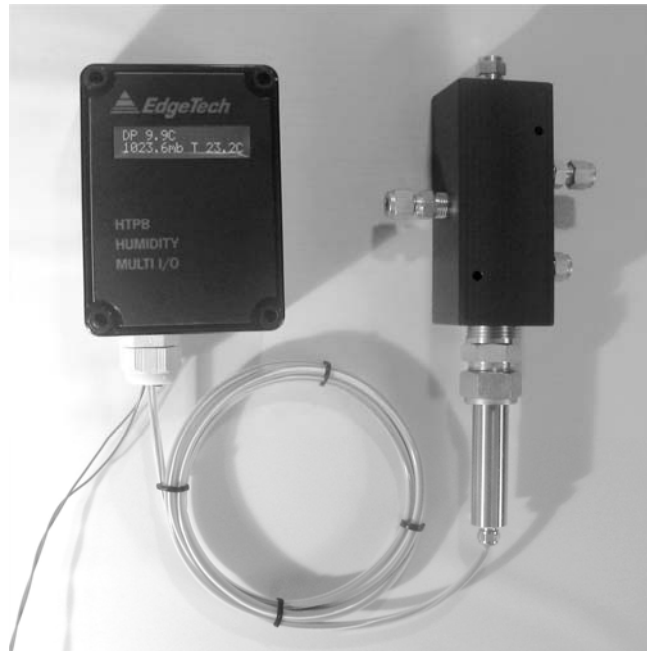

Figure 4-1, System with Sample Cell, ready for mounting

4.2 MOUNTING THE REMOTE ELECTRONICS MODULE

MOUNTING CONSIDERATIONS

1. If the Digital Display has been provided, is it easily visible?
2. Is the location convenient for routing electrical wiring?
3. Is the module within 6 feet (1.8 meters) of the Sensor location?

Use a small hammer to tap in the pins that hold the four corner mounting lugs in place. See Figure 4-2 below. Mount the box to a flat surface with screws or bolts through the 4 mounting holes.

Figure 4-2 a,b,c,d
Installing Mounting Lugs

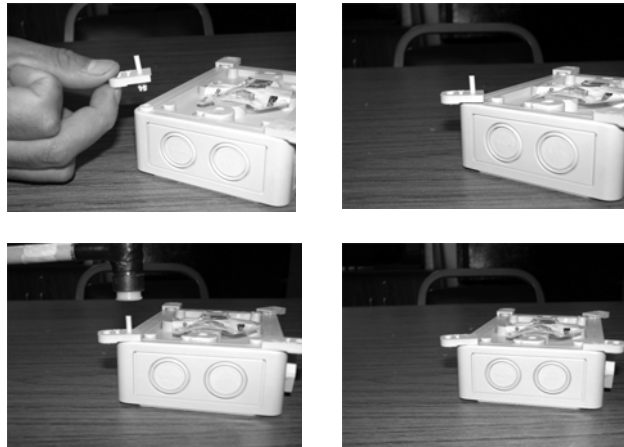

4.3 ELECTRICAL WIRING

4.3.1 PROBE ONLY

See Wiring Table 4-1 and Figure 4-3 below.

1. Connect Power Supply wiring as shown. The Positive voltage output of the supply is connected to the Yellow wire. The Negative output of the supply is connected to the Green wire.
2. Connect the Analog Output wiring as shown. Three 0 to 10 Vdc outputs are available. Connect Outputs 1, 2, and 3 as required, observing the color codes.
3. Connect the RS-232 Serial Output if desired. Only 2 wires are required if the output is needed for transmitting information only. A third wire is added for bi-directional communications with the serial port.

Table 4-1 HTPB Probe Wiring Table

ITEM	COLOR CODE
Power Supply – Pos.	Yellow
Power Supply – Neg.	Green
Output 1 – Pos.	Brown
Output 2 – Pos.	Red
Output 3 – Pos.	Orange
Output Common	Black
Serial Output – TX	Blue
Serial Output – RX	White
Serial Common	Green

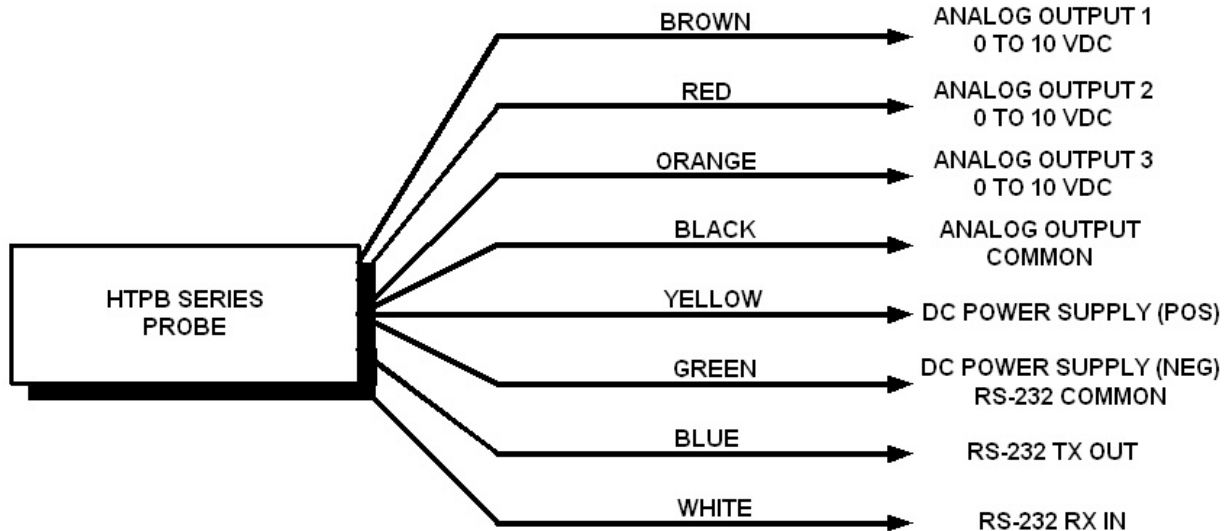

Figure 4-3 HTPB Probe Wiring Diagram

4.3.2 PROBE WITH ELECTRONICS MODULE

See Tables 4-2, 4-3, and Figure 4-4 below.

Notes:

1. Cable bushings are shipped separately. Carefully tap out the desired knockouts, and mount the bushings.
2. We recommend that you route the Probe Cable through a bushing on the left. Route all other wiring through the bushing on the right.

1. Run the cable from the Probe to the connector labeled Probe Input.
2. Wire the Power Supply as shown in Table 4-2.
3. Wire the three 4 to 20 mA Analog Outputs and Alarm Relays as shown in Table 4-2 if desired.
4. Connect to the RS-232C Serial Port at J6 if desired.

Table 4-2 Electronics Unit Wiring Table

ITEM	CONN.	TERM.
Power Supply (+)	J8	2
Power Supply (-)	J8	1
Analog Out 1 (+)	J9	1
Analog Out 1 (-)	J9	2
Analog Out 2 (+)	J9	3
Analog Out 2 (-)	J9	4
Analog Out 3 (+)	J9	5
Analog Out 3 (-)	J9	6
Alarm Relay 1	J2	1
Alarm Relay 1	J2	2
Alarm Relay 2	J2	3
Alarm Relay 2	J2	4

Table 4-3 J6 Wiring Table

DB-9 SERIAL CONNECTOR	ITEM
Pin 2	TX
Pin 3	RX
Pin 5	RTN

Figure 4-4 Electronics Unit Wiring

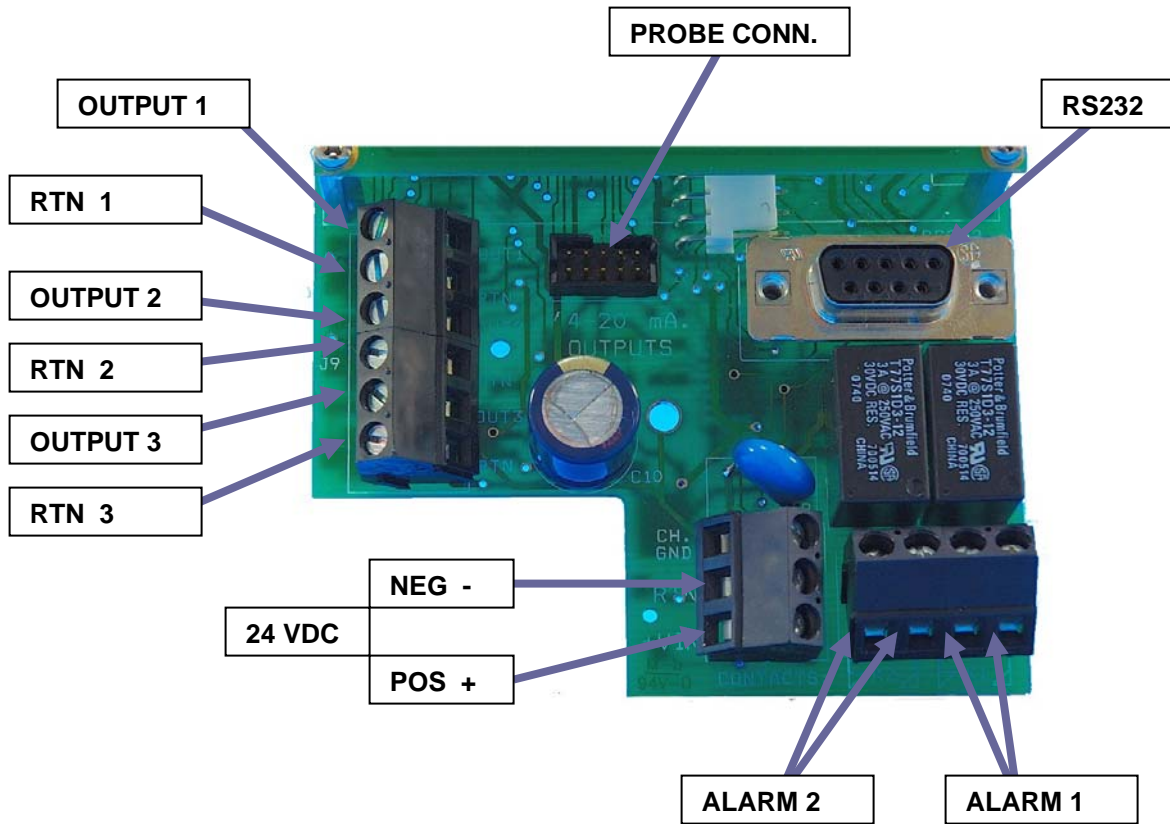

BASIC BLOCK DIAGRAM THEORY OF OPERATION

5.1 PROBE ASSEMBLY

See Figure 5-1, the Probe Assy. Basic Block Diagram.

The Probe Assembly is a stand-alone, completely self-contained measuring system. All units include the RH and Temperature Sensors, and some optional probes include a Pressure Sensor as well. The field-replaceable Sensor Circuit Board has standardized output levels for all three measured parameters. Therefore, boards may be quickly replaced while in operation without the need for recalibration, maintaining full system accuracy. The Microprocessor performs the system control, parameter calculation, and serial digital communications. Digital-to-Analog (D-A) conversion provides three 0 to 10 Vdc linear Analog Outputs corresponding to the measured and/or calculated parameters.

The serial digital RS-232 interface is bi-directional, allowing to user to not only receive and record measured information, but to remotely control output scaling, alarm relay setpoints, and other functions as well.

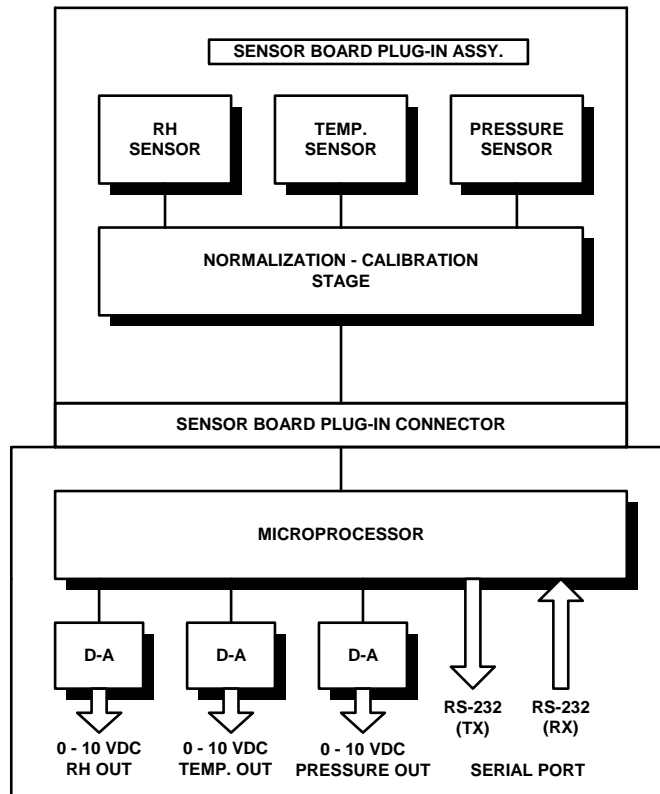

Figure 5-1 Basic Block Diagram, Probe Assy

5.2 HTPB ELECTRONICS MODULE (Type DIS)

Although the Probe may be used as a stand-alone measuring device, it also may be connected to the type DIS remote display unit, for additional capability. The complete HTPB system consists of the Probe, the interconnecting 6 foot (1.8 meter) cable, and the electronics module. Outputs of the unit include a Serial Port, two Alarm Relays and three 4 to 20 mA Analog Outputs. A two-line LCD Digital Display is also included.

5.3 THE COMPLETE HTPB SYSTEM

Figure 5-2 is a basic block diagram of the complete Humidity, Temperature and optional Pressure measuring system. The remote Probe is connected, via the attached cable, to the electronics module. The system is completely controlled by the microprocessor in this module.

The three sets of analog voltage outputs from the Probe are routed through the Analog Scaling and Selection stage. The scaling of these output signals may be programmed by the user to any desired range by using the RS-232 Serial Port. The bi-directional RS-232 is brought out to a connector in the electronics module. The user can also program the two Alarm Relay set points via this digital interface. The built-in LCD Digital Display, which provides information on all measured parameters, is also controlled by the microprocessor. In addition, the microprocessor is used to calculate other parameters than those directly measured by the sensors in the Probe. These may be shown on the Digital Display, and they are also available on both the analog and digital (RS-232) outputs. The Alarm Relays may also be set for these calculated values.

Figure 5-2 System Basic Block Diagram

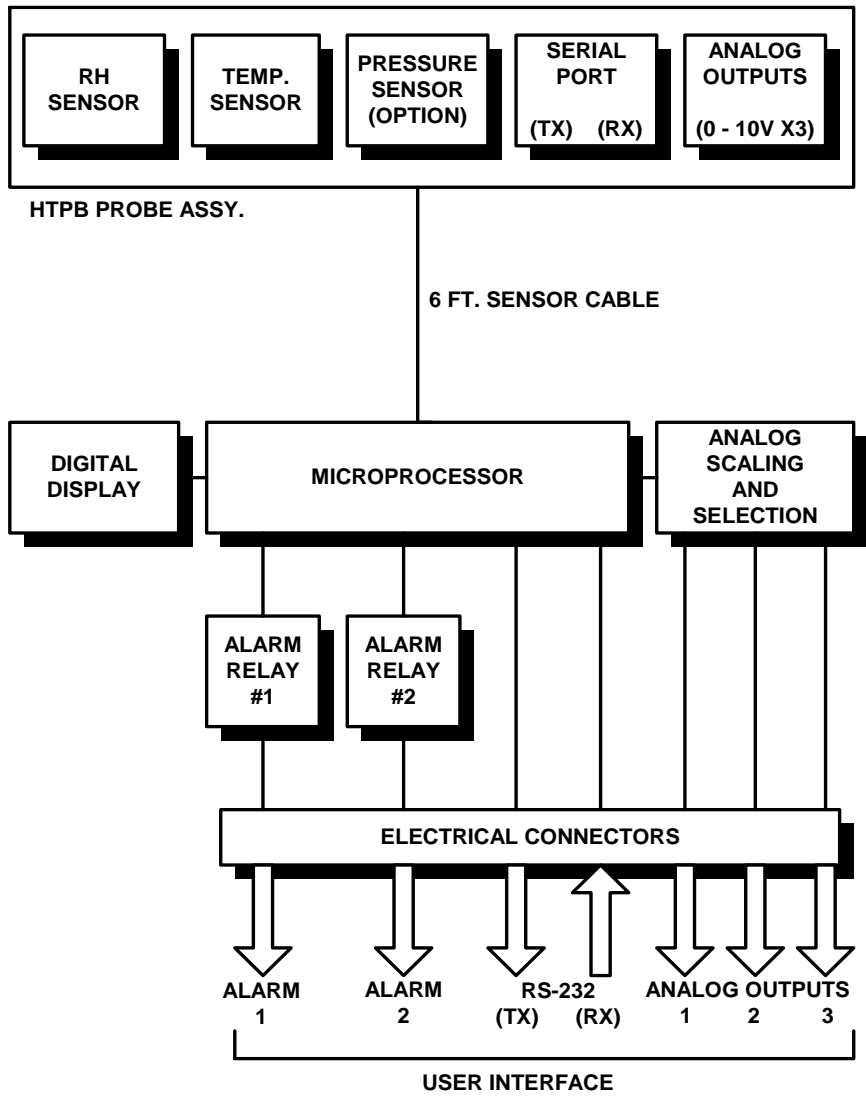

6.0 OPERATION

6.1 INITIAL BENCH TESTING

New units may be tested on the bench before installation, if desired.

For units consisting of the Probe only –

1. Connect a proper Power Supply to the correct wires.
Caution: Observe polarity!
2. Using a DC Voltmeter, measure the 0 to 10 Vdc Output and confirm that it corresponds to the room condition. (Humidity, Temperature, etc.)

For systems consisting of the Probe and the Electronics Unit –

1. Connect the Probe to the Electronics Module.
2. Connect a proper Power Supply to the correct terminals.
Caution: Observe polarity!
3. Measure the 4 to 20 mA Output as above, or read the Digital Display.
Confirm that the reading corresponds to the room condition.
(Humidity, Temperature, etc.)

6.2 NORMAL OPERATION

Note:

This section assumes that all required electrical wiring and mounting has been completed. See the Installation section for further information if necessary.

Use of the HTPB series of probes is extremely simple. There are no controls to operate during normal use, as these devices are designed for long-term unattended operation. With the Analog Outputs, Digital Outputs, and/or Alarm Relays connected to a Data Acquisition System, Recorder, Process Controller, Computer, or Terminal, the user has only to periodically monitor the system for normal operation.

6.3 FACTORY DEFAULT RANGES

See Table 3-2 for information on the measurement ranges provided by the Factory. The maximum range limits are also shown in Table 3-2.

The scaling of the default measurement ranges may be changed in the field via the Serial Port if required. See Section 6.4 below for range-changing instructions.

6.4 USING THE RS-232C SERIAL PORT TO PROGRAM YOUR SETTINGS

6.4.1 SERIAL PORT SETUP

Plug a standard RS-232 cable into the DB-9 connector on the circuit board in the Type DIS Humidity Multi I/O Electronics Unit. Plug the other end into your terminal or computer.

Program the Hyperterminal settings as follows:

- Baud Rate: 19.2K
- Data Bits: 8
- Parity: None
- Stop Bit: 1
- Flow Control: None

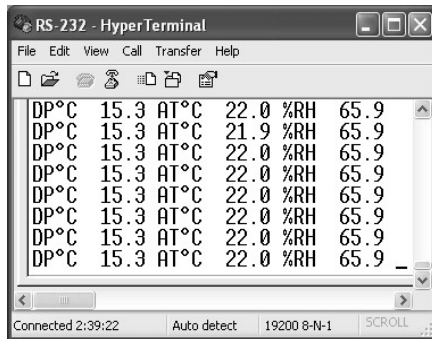

You should now see flowing data on your monitor, displaying the same information as the Multi I/O front panel Digital Display, with a rapid update rate. If you do not, check your serial port settings and connections.

NOTE: WHEN PROGRAMMING ALPHABETIC CHARACTERS, USE UPPER CASE ONLY.

6.4.2 CHANGING THE DIGITAL DISPLAY

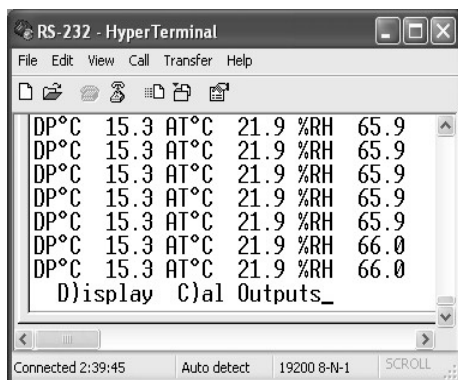

You can select any measured or calculated parameters to appear on the front panel Digital Display. Proceed as follows:

Press the “Escape” key on your keyboard. You will see “D)isplay C)al Outputs” as

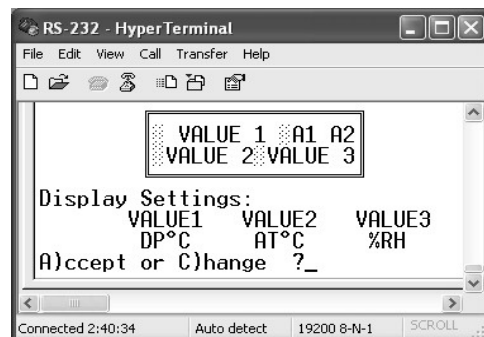

shown here.

Press “D”, selecting to change the Display. (We will C)alibrate the Outputs later.) You will then be given a choice whether to keep the

present settings or to change them. For this example, we will C)hange them. Press “C”. You can then select the parameter to insert by cycling through the options using the Space Bar. In this case, we will change VALUE 1, the Dew Point reading, from DP°C to DP°F. Press Enter to save your change and advance to the next value. Next, do the same for Air Temperature. When completed, press Enter again to save and advance. For this example, we will choose not to change the %RH value. Instead, press “X” for eX)it.

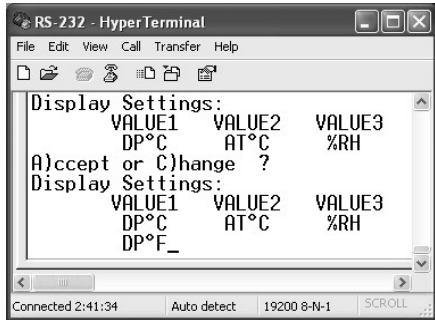

When programming is completed, press “A” to accept the changes.

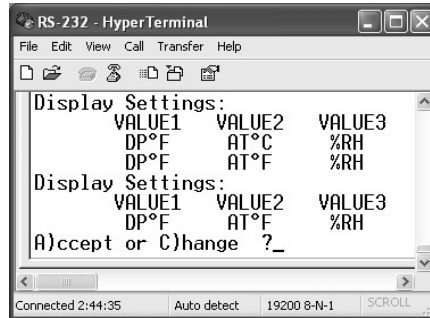

6.4.3 CHANGING THE OUTPUT RANGES

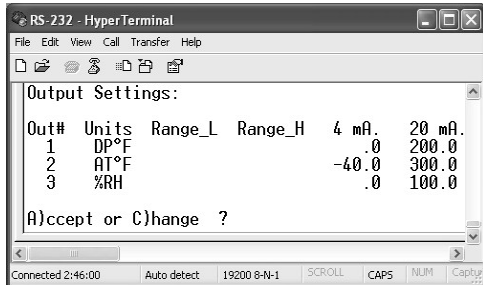

The next window to be seen will be the Output Settings screen. Here, you can modify the 4 to 20 mA Analog Output ranges. To enter this mode, press “C” for C)hange. You will see the Set Output screen shown here.

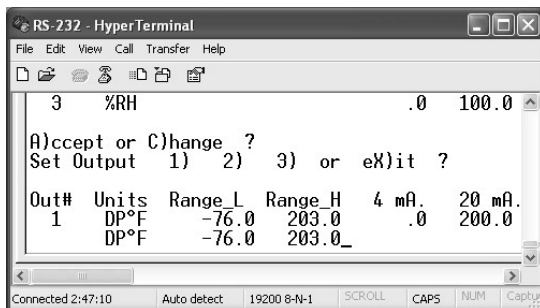
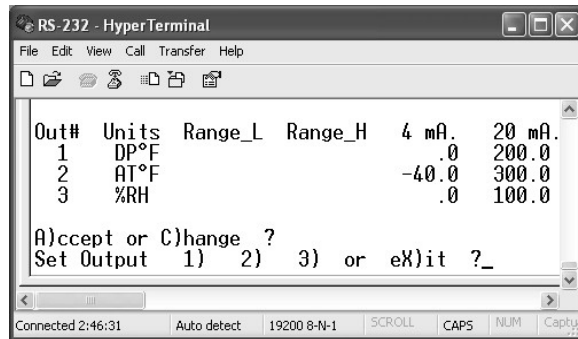

To change Output 1, select “1”. You will see this screen, which shows the present settings for Output 1.

Example: We would like to change DP°F to a range of -40 to 200 °F. Press Enter. Enter -40. Press Enter again. Enter 200. Press Enter again. To Save the Changes, press “Y” for Y)es. To accept the changes, press “A” for A)cccept.

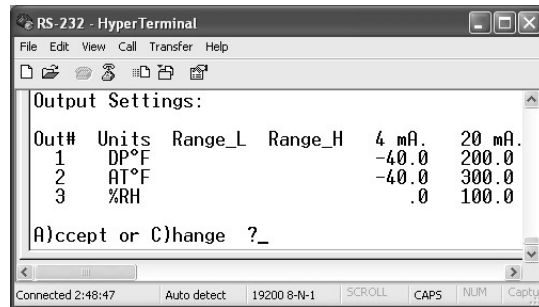
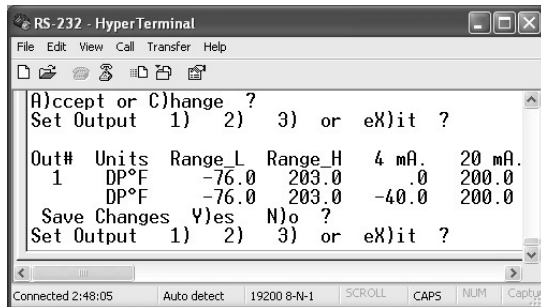

6.4.4 PROGRAMMING THE ALARM RELAYS

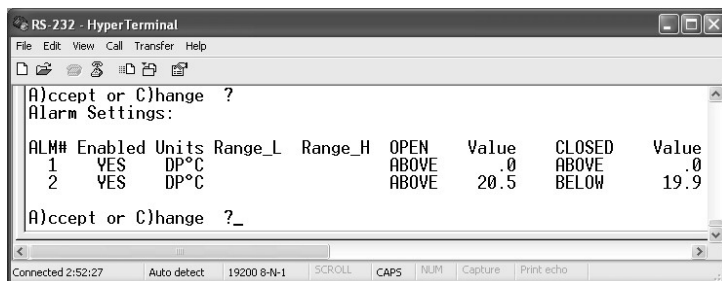

The system will then step to the Alarm Relay mode. The two relays are Form A, (single-pole, single-throw), normally open. You can independently program the “ON” point and the “OFF” point for each relay. To enter the menu, press “C” for C)hange.

We would like to change Alarm 2 to these parameters:

Open > a reading of 10 °C
Close < a reading of 10 °C

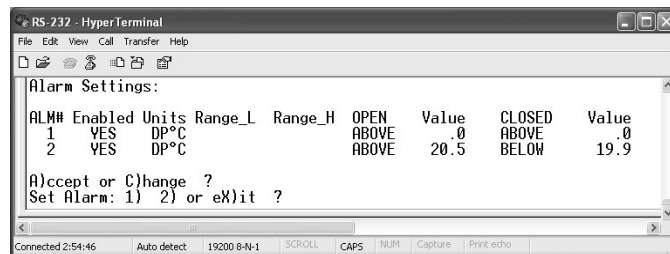

NOTE: IN ACTUAL OPERATION YOU SHOULD PROGRAM IN A SMALL OVERLAP, SO THAT THE RELAY DOES NOT CHATTER WHEN THE MEASURED READING IS EXACTLY AT THE SETPOINT. THIS IS CALLED “HYSTERESIS.”

Press “2” to set Alarm 2. You will note that Alarm 2 is set for Air Temperature, AT°C. Under OPEN, insert 10 and press “Enter.” Under CLOSED, insert 10 and press “Enter.”

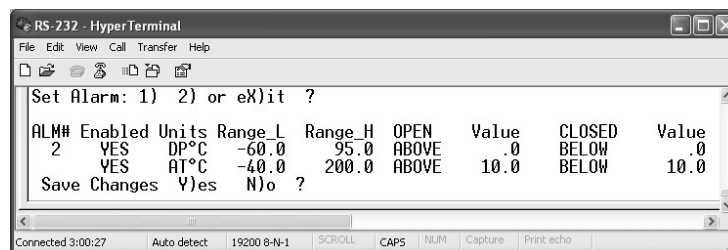

You will be asked to Save the Changes. Press “Y” for Yes.

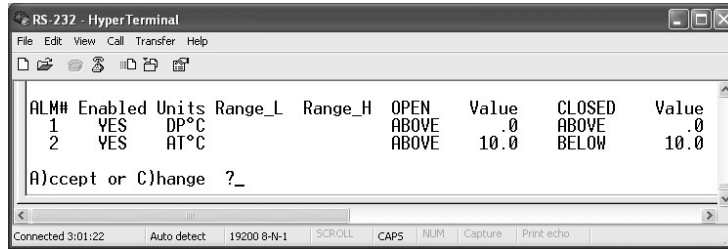

Then, press “A” for A)cccept.

The program will then automatically return to the normal mode, displaying data that is continuously updated.

6.4.5 CALIBRATING THE ANALOG OUTPUTS

If you have a precise milliammeter, you can easily calibrate the three 4 to 20 mA analog outputs. In order to utilize this convenient capability, connect the meter in series with one of the analog outputs and the load.

Press the “Escape” key on your keyboard, which will interrupt the data stream and give you the choice of D)isplay or C)al Outputs. Select “C”.

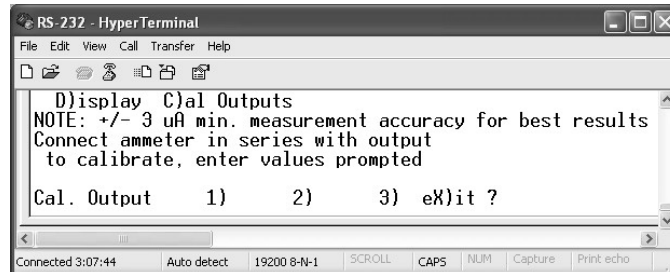

In order to calibrate Output 1, press “1”. You will then be able to insert the desired current value at the 1/4 FS (25% of Full Scale) point and at the 3/4FS (75% of Full Scale) point. For 4 to 20 mA, 1/4FS is 8 mA, and 3/4FS is 16mA.

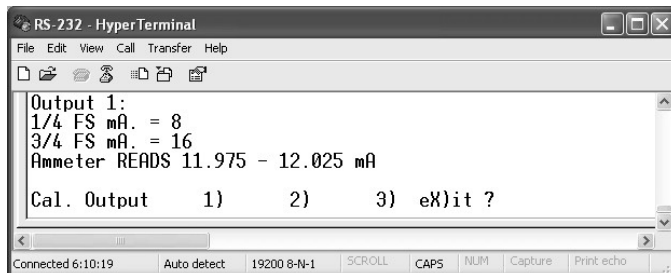

Insert these values, pressing “Enter” after each one. You will then see a range of what the milliammeter should read in order to attain the desired accuracy.

Then select “X” for eX)it. The system will now return to the normal data

reading mode.

7.0 MAINTENANCE

7.1 SENSOR CIRCUIT BOARD

Inside the barrel of the Sensor probe, mounted directly at the tip, is the plug-in sensor circuit board. This board has been calibrated at the Factory for a standard output level. Since all boards have been calibrated for the same normalized level, they may be replaced in the field without the requirement for recalibration, while maintaining the full published system accuracy specification.

7.1.1 REPLACING THE SENSOR CIRCUIT BOARD

See Figure 7-1. At the tip of the Sensor probe is a snap-ring, or retaining ring. It must be removed in order to gain access to the Sensor board. There is a groove at one end



of the ring. Using a very small screwdriver or a small knife blade inserted into the groove in the retaining ring, lift it out of the machined groove in the inside of the sensor shield barrel. The ring can then be removed, allowing access to the interior of the sensor assembly.

Figure 7-1 Removing the Retaining Ring

7.1.2 REMOVING THE RETAINING COMPONENTS

Figure 7-2 shows the sequence of parts that must be removed in order to gain access to the sensor board. All are easily removed once the retaining ring is out. Store them carefully for re-installation later in the proper sequence.

The final item to be removed in the sequence is the plug-in sensor circuit board, which can be seen through the slot in the sensor shield. There is a small hole near the tip of the board to aid in removal. Inserting a small screwdriver in this hole and pulling upward gently, unplug the board from the socket built into the probe.

Note: The small humidity sensor can be seen mounted near the tip of the board. This is fragile. Take care not to break it during board removal or installation.

7.1.3 SENSOR REASSEMBLY

Carefully plug the new sensor circuit board into the socket, noting that it is installed at the correct angle and properly aligned. Using a small screwdriver in the hole near the tip, press it down sufficiently so that it is fully inserted in the socket.

Install the bushing in the direction shown in Figure 7-2. Then install the spring, O-ring, and the sintered filter. Finally, while pressing on the end of the sintered filter to compress the spring, snap the retaining ring back into the slot on the inside of the sensor shield. Be sure that it is inserted completely, so that it will securely retain the sensor components in place.

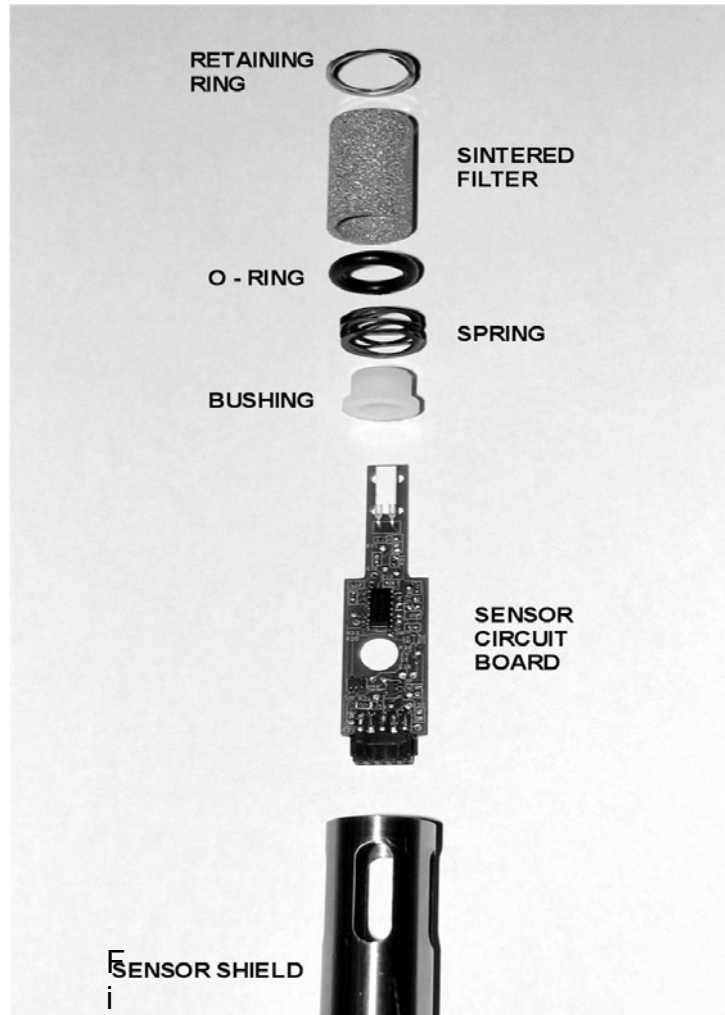

Figure 7-2 Sensor Exploded View

8.0 SPECIFICATIONS

Note: See Table 3-2 for actual measurement ranges.

HT75/HT115N (Sensor Only)

Measured Parameters – RH/Temp.
RH Accuracy – +/- 1% RH
Temp. Accuracy – +/- 0.5°C
Output Information – RH, Temp., DP
Electrical Outputs – 0 to 10 Vdc (X3)
RS-232C

HTB75/HTB115N (Sensor Only)

Measured Parameters – RH/Temp./Barometric Pressure
RH Accuracy – +/- 1% RH
Temp. Accuracy – +/- 0.5°C
Pressure Accuracy – +/- 5 mb
Output Information – RH, Temp., Pressure
Electrical Outputs – 0 to 10 Vdc (X3)
RS-232C

HTP75/HTP115N (Sensor Only)

Measured Parameters – RH/Temp./Pressure
RH Accuracy – +/- 1% RH
Temp. Accuracy – +/- 0.5°C
Pressure Accuracy – +/- 0.75 psi
Output Information – RH, Temp., Pressure
Electrical Outputs – 0 to 10 Vdc (X3)
RS-232C

HT60W/HT60D (Electronics Unit with Built-in Sensor)

Measured Parameters – RH/Temp.
RH Accuracy – +/- 1% RH
Temp. Accuracy – +/- 0.5°C
Output Information – RH, Temp., DP
Electrical Outputs – 4 to 20 mA (X3)
RS-232C
Alarm Relays (X2)
Digital Display – LCD, 2-line

HT75DIS and HT115 (Electronics Unit with Remote Sensor)

Measured Parameters – RH/Temp.

RH Accuracy – +/- 1% RH

Temp. Accuracy – +/- 0.5°C

Output Information – RH, Temp., DP

Electrical Outputs – 4 to 20 mA (X3)

RS-232C

Alarm Relays (X2)

Digital Display – LCD, 2-line

HTB60W/HTB60D (Electronics Unit with Built-in Sensor)

Measured Parameters – RH/Temp./Barometric Pressure

RH Accuracy – +/- 1% RH

Temp. Accuracy – +/- 0.5°C

Pressure Accuracy – +/- 5 mb

Output Information – RH, Temp., Pressure

Electrical Outputs – 4 to 20 mA (X3)

RS-232C

Alarm Relays (X2)

Digital Display – LCD, 2-line

HTB75DIS and HTB115 (Electronics Unit with Remote Sensor)

Measured Parameters – RH/Temp./Barometric Pressure

RH Accuracy – +/- 1% RH

Temp. Accuracy – +/- 0.5°C

Pressure Accuracy – +/- 5 mb

Output Information – RH, Temp., Pressure

Electrical Outputs – 4 to 20 mA (X3)

RS-232C

Alarm Relays (X2)

Digital Display – LCD, 2-line

HTP75DIS and HTP115 (Electronics Unit with Remote Sensor)

Measured Parameters – RH/Temp./ Pressure

RH Accuracy – +/- 1% RH

Temp. Accuracy – +/- 0.5°C

Pressure Accuracy – +/- 0.75 psi

Output Information – RH, Temp., Pressure

Electrical Outputs – 4 to 20 mA (X3)

RS-232C

Alarm Relays (X2)

Digital Display – LCD, 2-line

Electrical Outputs

Systems with Sensor only –

0 to 10 Vdc (X 3) @ 10 mA max.

RS-232C (bi-directional)

Systems with Sensor and Electronics Unit—

4 to 20 mA (X3) into 500 Ω max.

Alarm Relay (X2) Form A (SPST, NO) rated at 3A/250 Vac

RS-232C (bi-directional)

Serial Output (All Units)

RS-232C to DTE device. 19.2 kilobaud, 8 bits data, 1 stop bit, no parity

Power Requirements

18 to 30 Vdc unregulated, 50 mA max.

Dimensions

Remote Sensor – Diameter: $\frac{3}{4}$ in. OD (1.9 cm)

Length: 8 inches (20.3 cm)

Cable Length – 6 feet (1.8 meters)

Consult Factory for longer lengths.

Electronics Module, Model DIS –

Outside Dimensions (HWD)

5.1 X 3.7 X 2.2 inches (13 X 9.4 X 5.6 cm)

Mounting Centers

4.52 X 3.11 inches (11.5 X 7.9 cm)

Electronics Module with Built-in Sensor –

Wall Mount – Outside Dimensions (HWD)

5.1 X 5.1 X 3.0 inches (13 X 13 X 7.6 cm)

Mounting Centers

4.52 X 4.52 inches (11.5 X 11.5 cm)

Duct Mount – Outside Dimensions (HWD)

3.74 X 6.8 X 2.0 inches (95 X 17.3 X 5.1 cm)

Mounting Centers

2.7 X 6.4 Inches (6.9 X 16.2 cm)

Sensor Pressure Rating

200 psia maximum

Sensor Sintered Filter

Material – Stainless Steel

Porosity – 40 microns

9.0 APPENDIX

9.1 Warranty Information

9.2 Mounting Dimensions

9.3 Basic Humidity Definitions

9.1 WARRANTY INFORMATION

All equipment manufactured by EdgeTech is warranted against defective components and workmanship for repair at their plant in Massachusetts, USA, free of charge, for a period of twelve months. Malfunction due to improper use is not covered in this warranty and EdgeTech disclaims any liability for consequential damage resulting from defects in the performance of the equipment. No product is warranted as being fit for a particular purpose and there is no warranty of merchantability. This warranty applies only if (i) the items are used solely under the operating conditions and in the manner recommended in the instruction manual, specifications, or other literature; (ii) the items have not been misused or abused in any manner or repairs attempted thereon; (iii) written notice of the failure within the warranty period is forwarded to EdgeTech and the directions received for properly identifying items returned under warranty are followed; and (iv) the return notice authorizes EdgeTech to examine and disassemble returned products to the extent EdgeTech deems necessary to ascertain the cause for failure. The warranties expressed herein are exclusive. There are no other warranties, either expressed or implied, beyond those set forth herein, and EdgeTech does not assume any other obligation or liability in connection with the sale or use of said products.

Equipment not manufactured by EdgeTech is supported only to the extent of the original manufacturer's warranties.

9.2 OVERALL AND MOUNTING DIMENSIONS

9.2.1 WALL MOUNT DIMENSIONS

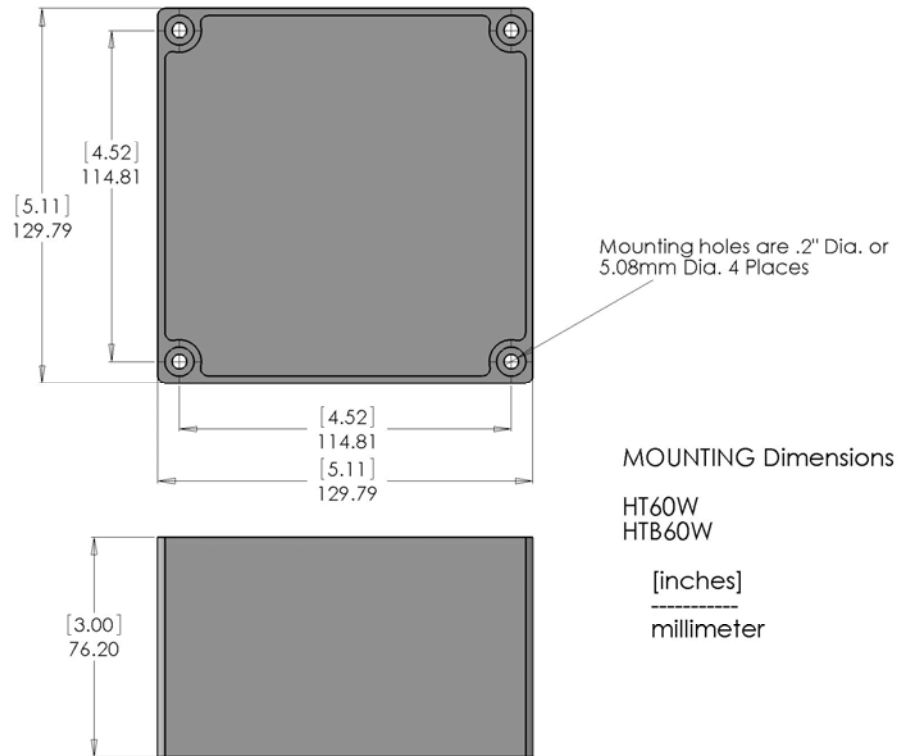

9.2.2 DUCT MOUNT DIMENSIONS

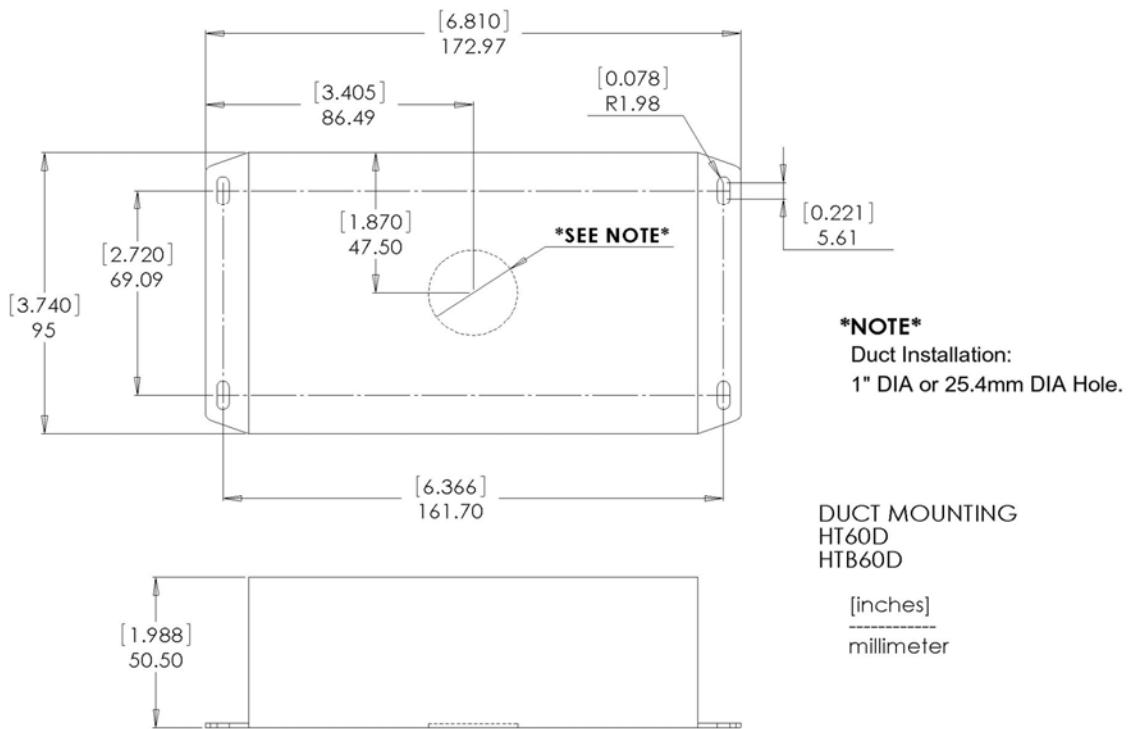

Notes