

MC2

SERIES CALIBRATORS



User Guide

Dear user,

We have made every effort to ensure the accuracy of the contents of this manual. Should any errors be detected, we would greatly appreciate to receive suggestions to improve the quality of the contents of this manual.

The above notwithstanding, we can assume no responsibility for any errors in this manual or their eventual consequences.

We reserve rights to make modifications to this manual without any further notice.

For more detailed technical data about the MC2 Series Calibrators, please contact the manufacturer.

© 2004-2016

BEAMEX OY AB

Ristisuonraitti 10

FIN-68600 Pietarsaari

FINLAND

Tel +358 - 10 - 5505000

Fax +358 - 10 - 5505404

**E-mail: sales@beamex.com
support@beamex.com**

Internet: http://www.beamex.com

8812000 / MC2uEng / Version 3c

Trademarks and Statements

QCAL® is a registered trademark owned by Beamex Oy Ab.
Other trademarks are property of their respective owners.

MC2 contains licensed software which requires that the source code is available for You. Please contact Beamex to obtain it.

MC2 is based in part on the work of the FLTK project
(<http://www.fltk.org>).

Contents

Part A, General

Introduction	2
About This Manual	3
Typographical Conventions	3
Unpacking and Inspection	4
MC2 Hardware	5
Connections	6
Pressure Modules	7
Connectors on the Left Side of MC2.....	8
Terminals	8
Support for Table Top Use.....	9
Memory	9
Display.....	9
Keyboard.....	10
Batteries	11
About the Charger and the Charging Procedure	12
Removing/Replacing the Batteries.....	13
Capacity Indication.....	14
PC Communication with USB	15
MC2 Firmware	16
General Description.....	16
Startup Procedure	16
Basic Mode and Higher Level Functions	16
Basic Mode's User Interface	17
The Status Bar	17
Windows 1 and 2	17
The Function Key Bar	18
Menu	18
Configuration Windows	19
Field Types Available for Editing Data	20

MC2's Modularity and Options 24

 Hardware Modules/Options..... 24

 Other Devices..... 25

Safety 26

 Symbols Used 26

 Safety Precautions and Warnings..... 27

 General Warnings 28

 Warnings Concerning Electrical Measurement and Generation..... 28

 General Warnings Concerning Pressure Measurement 29

 Warnings Concerning High Pressure 30

Disposal of Waste Electrical and Electronic Equipment 31

Service 32

 Firmware Update..... 32

 The Battery Charger..... 32

 Resetting MC2 32

 Recalibrating MC2..... 33

 Cleaning MC2..... 33

Part B, Startup and Basic Operation

Starting MC2	36
Startup Procedure	36
Basic Mode, Defined	37
Measuring	39
Current Measurement	41
Frequency Measurement	43
Pressure Measurement	44
Connecting and Disconnecting External Pressure Modules.....	45
Zeroing a Pressure Module.....	46
Pulse Counting.....	47
Resistance Measurement	48
Switch State Sensing	49
Temperature Measurement (RTD).....	51
Temperature Measurement (Thermocouple)	52
Voltage Measurement	53
Generating/Simulating	54
Changing the Generated/Simulated Value.....	55
Spinning and Manual Stepping	55
Current Generation.....	57
Frequency Generation	59
Pulse Generation.....	60
Resistance Simulation.....	61
RTD Sensor Simulation.....	62
Thermocouple Simulation	64
Voltage Generation	66

Tools Menu	67
Function Info.....	68
Alarms	69
Damping	70
Leak/Stability Test.....	71
Stepping	73
Ramping	76
Manual Stepping	78
Display Mode and Special Measurements.....	81
Error %.....	82
Error in Input Units	83
Error in Output Units	84
Percentage.....	85
Scaling	86
Deviation	87
Redundant	88
Difference.....	89
Showing Data on the Additional Info Row.....	90
Resetting and Clearing Additional Info Row / Calculations.....	93

Part C, Advanced Operation and Configurations

Utilities Menu	96
About This Calibrator	96
User Setups for ❶ & ❷	97
Date/Time.....	98
General Settings.....	99
Calibrator Adjustment.....	100
Custom Test Point Sets.....	101
Custom Transfer Functions	103
Custom Pressure Units	106
Related Information	107
Things to Consider when Measuring Pressure	108
General	108
Pressure Type.....	108
Pressure Modules and their Naming Conventions	109
Square Rooting	110
Thermocouple Measurement/Simulation, Connections and Troubleshooting.....	111
Internal Reference Junction	111
External Reference Junction.....	112
Error situations	115
Resistance and RTD Measurement, Connections	116
4-wire System	116
3-wire System	116
Using a Compensation Loop.....	117
2-wire System	117
Current Measurement Parallel to a Test Diode, Connections.....	118
Parallel Functions in MC2	119

Part D, Calibration

General	122
Phases of Instrument Calibration	123
As Found Calibration	124
Adjustment	124
As Left Calibration.....	125
Calibrating an Instrument	126
A Calibration Procedure Using MC2	126
Examples of Instrument Calibration	127
Pressure Transmitters.....	128
Temperature Indicators and Recorders	130
Electrical Limit Switches	132
Temperature Sensors	134
Pneumatic Pressure Transmitters and Converters.....	136

Appendixes

Appendix 1, Technical Data	140
MC2 General Specifications	140
Pressure Modules	141
Internal Pressure Modules (IPM)	141
External Pressure Modules (EXT), High Accuracy	142
External Pressure Modules (EXT), Standard Accuracy	144
Electrical Measurements	145
Voltage Measurement	145
Current Measurement	145
Frequency Measurement	146
Pulse Counting	146
Switch Test	146
Electrical Generation, Sensor Measurement and Simulation	147
mV Measurement (T/C-Terminals)	147
mV Generation (T/C-Terminals)	147
Voltage Generation	148
mA Generation (Source/Sink)	148
Resistance Measurement	149
Resistance Simulation	149
Frequency Generation	150
Pulse Generation	150
Temperature Measurement and Simulation	151
RTD Measurement and Simulation	151
Thermocouple Measurement and Simulation	154
Appendix 3, Index	158

Feedback

We want to improve our products and services constantly. Therefore we'd like to know Your opinion of the product You use. Please spend a moment of Your valuable time in filling this form. All respondents will receive a surprise gift in return.

Certain questions can be answered immediately after receiving the product. Others require some use of the product before You are able to answer them. The best way to fill the form is to answer the items as it applies, and send the form to us when all items are answered. There are however no definite restrictions; fill in the form when you feel like it (all items need not be answered). Then send it to Beamex using one of the possibilities listed below.

Mail: **Beamex Oy, Ab**
Quality Feedback
P.O. Box 5
68601 Pietarsaari
FINLAND

Fax **+358 - 10 - 5505404**
Only the next page need to be faxed to us.

Internet: **<http://www.beamex.com>**
A similar form is available as a web page

E-mail: **support@beamex.com**
Refer to the numbered items on the next page in Your e-mail message.

1. Name of the product you give feedback of: _____

2. Serial number and software version number (if applicable) _____

3. Any comments when receiving the product. Did the package contain all required items and was it as expected?

4. For how long have you been using the product? _____

5. How helpful was the manual in using the product?

(Tick a box in the percentage scale below)

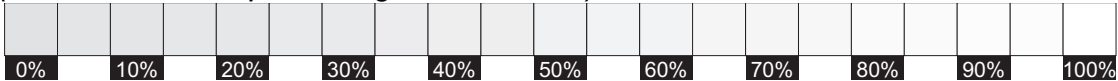

6. How well did the product suit your needs?

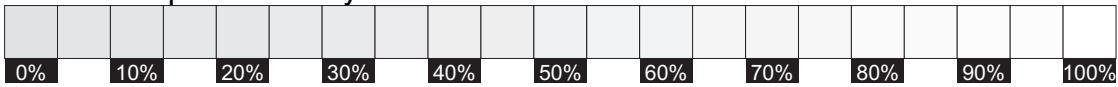

7. How satisfied are you with the product?

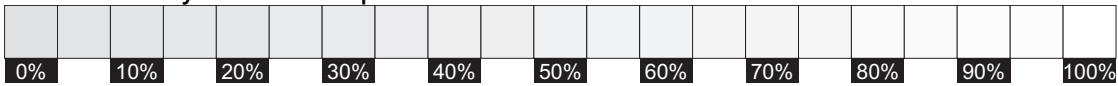

8. Did anything in the product exceed your expectations? In that case, what was it?

9. Did anything in the product disappoint you? In that case, please specify.

10. Any ideas You want to propose to Beamex so that we can improve our products, operations and/or services.

Please fill in these fields in order to receive your surprise gift.

Title & Name:

Address:

Please contact me concerning the Feedback I have given.

I want to receive more information on Beamex products.

Size (tick one)

XS S M L XL XXL

General

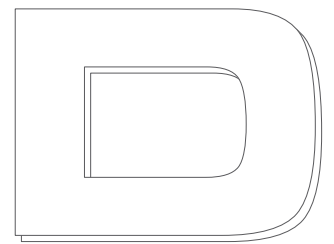
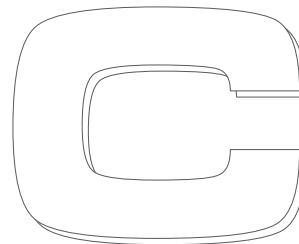
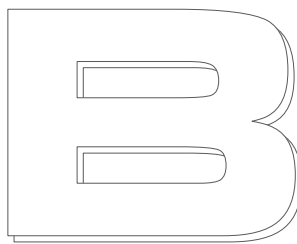

Things discussed in Part A:

- An introduction to what MC2 is and what the parts of this User Guide concentrate on.
- A general description of MC2's hardware.
- A general description of MC2's firmware.
- The modularity and options of MC2.
- Safety precautions and warnings.
- Briefly about how to service MC2.

Introduction

The MC2 series calibrators are compact hand-held calibrators with an easy to use graphical user interface. The calibration capabilities vary depending on the model at hand:

- **MC2-PE** is meant for calibrating pressure instruments.
- **MC2-TE** is intended for calibrating temperature instruments.
- **MC2-MF** is a fully equipped multifunction calibrator including the capabilities of both MC2-PE and MC2-TE.

To find out which model you have, see the sticker on the back side of your MC2.

This manual describes the features of all MC2 models. If a feature is not included in a certain model, it is mentioned in the beginning of the feature's presentation.

Being a Beamex calibrator, MC2 represents the high, uncompromised quality standards evident in other Beamex calibration equipment. It is another MC calibrator you can rely on and a calibrator that completes your range of MC calibrators.

About This Manual

This User Guide is divided in four parts: A, B, C and D.

- **Part A** discusses general matters. There is also a chapter about safety.
- **Part B** describes the basic use of MC2 such as measuring signals and setting up Display Modes and Special Measurements.
- **Part C** handles configuration level usage and also offers more information concerning measurements/simulations.
- **Part D** concentrates on the calibration of instruments.

The even page header displays the title of the active part. The odd page header displays the main subject (Heading level 1).

The header of each odd page also indicates the active part as shown in the adjacent picture (with Part B active).



Use the information provided in the headers as a quick guide when searching for a particular subject.

Typographical Conventions

All examples of user interface texts are printed using **Bold Font**, e.g.

Field: **Trigger Level**

All front panel texts (fixed texts on MC2's cover) are printed using **Narrow Font**, e.g.

Function Key **F1**

Function and Menu keys are often referred to using both the key name in **Narrow Font** and the corresponding text (function) displayed on the screen in **Bold Font**, e.g.

Function Key **F3/Menu**

Unpacking and Inspection

At the factory each new MC2 passes a careful inspection. It should be free of scrapes and scratches and in proper operation order upon receipt. The receiver should, however, inspect the unit for any damage that may have occurred during transit. If there are signs of obvious mechanical damage, package contents are incomplete, or the instrument does not operate according to specifications, contact the purchasing sales office as soon as possible. The standard accessories are as follows:

- Calibration certificate,
- a warranty card,
- this User Guide,
- A CD-ROM with product information, USB driver etc.
- computer communication cable (USB),
- internal rechargeable NiMH batteries,
- battery eliminator/charger for the batteries,
- test leads and clips,
- a Cu-Cu adapter for millivolt measurement (not with MC2-PE) and
- a pressure connector adapter from G1/8" female to G 1/8" male with 60° internal cone (not with MC2-TE).

For a description of available options, see **MC2's Modularity and Options** on page 25.

If you have to return the instrument to the factory for any reason, use the original packing whenever possible. Include a detailed description of the reason for the return.

MC2 Hardware

General features:

- Integrated impact protectors
- A support for using the calibrator on the table
- Weight 720...830 g (1.59 ... 1.83 lbs) depending on model and installed pressure modules.
- Operating temperature: -10 ... +50 °C (14 ... 122 °F).
0 ... +35 °C (32 ... 95 °F) when charging the batteries.
- Storage temperature: -20 ... +60 °C (-4 ... 140 °F).
Note: The stickers and the batteries may be affected when storing longer periods in extreme conditions.
- Humidity: 0 ... 80 % R.H. non condensing

More comprehensive specifications are available in Appendix 1.

Connections

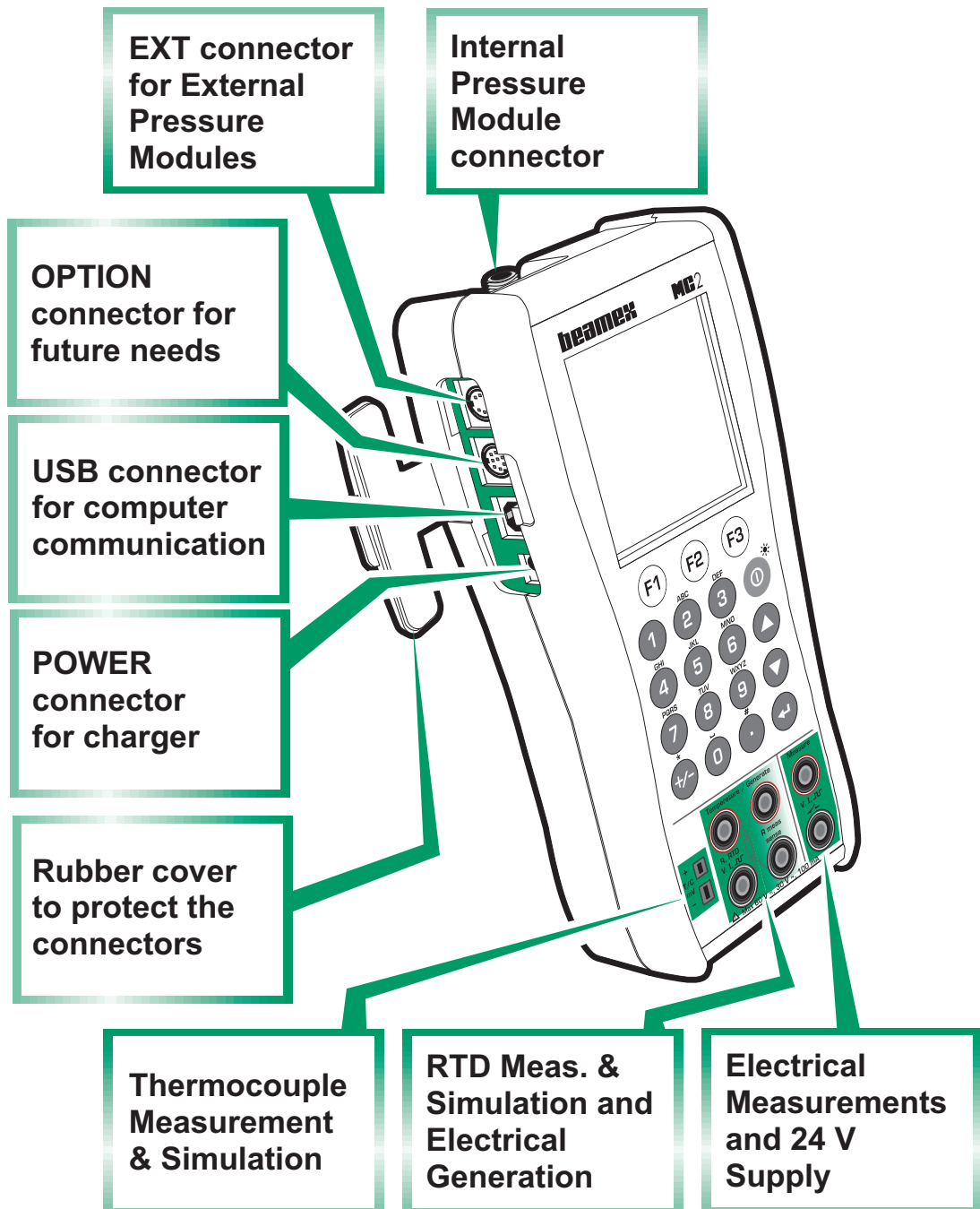

Note.

The picture above is of a model MC2-MF. MC2-TE does not have an internal pressure module. MC2-PE only has the Electrical measurement and 24 V terminals at the bottom of the front panel. .

Pressure Modules

Internal Pressure Module

Internal Pressure Modules are available in models MC2-MF and MC2-PE. One gauge type Internal Pressure Module may be installed into the aforementioned models. They may also include an additional Barometric Pressure Module.

The connector for the gauge type Internal Pressure module is located in MC2's upper panel.

The allowed pressure media for gauge type internal pressure modules is inert, non-toxic, non-explosive media. Use of pressure media classified as dangerous is prohibited.

For Beamex 60° cone connector: To avoid damaging the calibrator, use hand tightening only when connecting the pressure measurement hose (max. torque 5 Nm, approx. 3.6 lbf ft). If the use of tools is required to secure the connection, apply the counterforce with a spanner on the connector body's hexagonal part.

Remember to be cautious when working with pressure and pressure modules. See also chapters **Safety** on page 27 and **Safety Precautions and Warnings** on page 28.

External Pressure Modules

MC2 has a connector for External Pressure Modules (EXTs). The connector is located on the left side of MC2. External Pressure Modules, supported by MC2, may be connected to **all** MC2 models.

MC2 automatically recognizes when an External Pressure Module is connected or removed. More of pressure measurement in part B of this manual.

Connectors on the Left Side of MC2

The left side of MC2 (front view) has four connectors as follows:

EXT	External Pressure Modules are discussed in chapter External Pressure Modules on page 7 and in Part B of this manual.
OPTION	Reserved for future needs
USB	For computer communication, e.g. when updating the firmware and sending/receiving instrument data. For USB driver information, see chapter PC Communication on page 15.
POWER	Charger connector (Battery eliminator when using dry cells)

Warning!

There is no galvanic isolation between the connectors on the left side as well as the internal pressure module connector.

Terminals

The lower part of the front panel has terminals for measuring, generating and simulating signals. The terminals available vary depending on model at hand.

- Model PE has terminals for measuring **voltage**, **current** and **frequency**. It can also be used when counting **pulses** or detecting the state of a **switch**.
- Models MF and TE have the following additional terminals: **Thermocouple** measurement and simulation, **RTD** measurement and simulation, **voltage**, **current**, **frequency** and **pulse** generation.

Support for Table Top Use

The support gives you a good viewing angle when MC2 is placed on a table top.

Memory

MC2 maintains data very much like personal computers. Data is saved on a solid state memory that does not need any power to maintain its state. Solid state memory is shock proof so the data is not lost when the calibrator is transported.

Display

MC2 has a backlit LCD display. The resolution of the display is 160 x 160 pixels.

The backlight is turned on or off by briefly pressing the power button. Pressing the button for a longer time shuts down MC2. More of backlight settings in part C of this manual.



To tune the contrast of the display:

- Press **F1/Contrast** when either viewing the welcome screen or the General Settings screen.
- Use the up ▲ and down ▼ arrow keys to change the contrast.













The changed settings are automatically saved as default settings.

Keyboard

Function Keys

   The Function Keys are located below the display. The meaning of each Function Key varies depending on the situation. The lower part of the display indicates what the Function Key stands for at the moment.

Numeric Keys

		
		
		
		

The Number keys are used when entering numbers in numeric fields and letters in text fields (as in cellular phones).

Pressing the +/- key toggles the sign of the entered numeric value. In text fields, this key contains a set of symbols and Greek letters.

The Decimal key adds the decimal point to the numeric value that is currently edited. In text fields, this key contains additional symbols such as punctuation marks as well as super and subscript numbers.

Arrow Keys and Enter Key

 The arrow keys are used when moving the cursor on the screen. They also have several special functions in certain situations, e.g. when tuning the contrast of the display.

 The Enter key both starts and finishes the editing of all types of fields.



On/Off and Backlight Key

 The On/Off key switches MC2 on and off. Press the On/Off key for about half-a-second to switch on/off. This delayed function prevents accidental on/off switching of MC2.

When pressing the On/Off key briefly, it toggles the display backlight on and off.

Batteries

MC2 supports the use of both rechargeable batteries and alkaline batteries. When using alkaline batteries, you need a Dry Battery Cartridge. MC2 automatically detects the battery type.

The alkaline batteries to be used are:

- Type: AA
- Cell Voltage: 1.5 V
- Amount: 4

The charger for rechargeable batteries operates in the following environments:

- Voltage: 100 ... 240 VAC
- Frequency: 50/60 Hz

MC2 may be used while the Battery Pack is being charged. The charger may also be used together with the Dry Battery Cartridge. Then it acts as a Battery eliminator.

The maximum operating time without recharging varies depending on the usage of the display back light. Also the usage of the 24V transmitter supply affects the maximum operating time. Even with constant maximum load, the standard rechargeable batteries should last for 6 hours. A good average operating time is 12 hours..

If alkaline batteries are in use, the maximum operating time also depends on the quality of the batteries. An average operating time is approximately 4 hours.

Full batteries:



Empty batteries:



The upper left corner of MC2's display shows a picture of a battery. The whiter the picture is, the more acute is the need for recharging (or changing of the alkaline batteries).

Notes.

MC2's internal clock/calendar uses a small amount of power although the calibrator is switched off. Remember to check the capacity of the batteries from time to time although MC2 is not in use.

To avoid loss of date and time, change the batteries with the charger / battery eliminator connected.

See also chapter **Capacity Indication** on page 14.

About the Charger and the Charging Procedure

When charging the batteries the battery symbol and a plug symbol alternates on the status bar. When charging is ready, only the plug symbol is shown.

If MC2 is shut off and the charger is connected, a battery status bar appears. After a while an estimate of the remaining charge time appears below the battery status bar (see leftmost picture below).

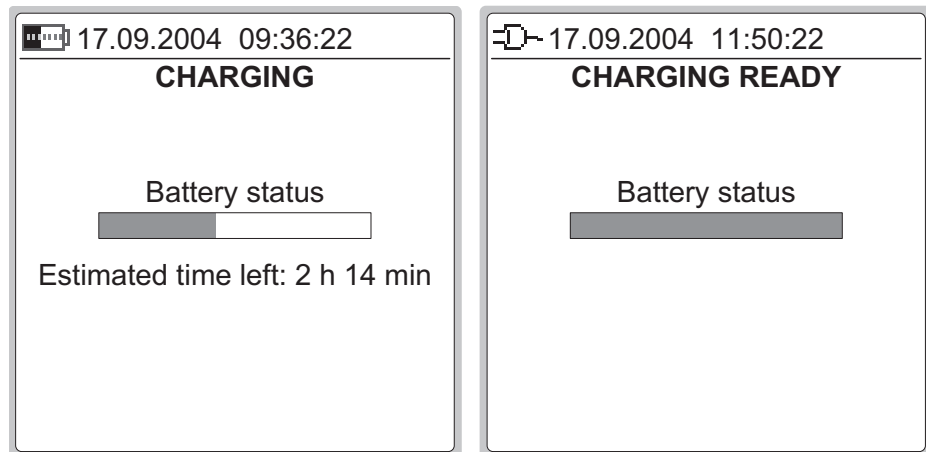

The charging time depends on calibrator's current consumption (backlight, mA sourcing etc.). With no extra load, the charging time is approx. 5 hours.

When charging while MC2 displays the charging window, MC2 beeps when the batteries are fully charged. Then the display looks like rightmost picture above.

Warnings!

USE ONLY THE CHARGER PROVIDED WITH THE CALIBRATOR.

The charger accepts input voltages from 100 to 240 VAC.

The charger should only be used indoors and the temperature should not exceed 35 °C (95 °F).

Removing/Replacing the Batteries

To remove or replace the batteries, perform the following procedure:

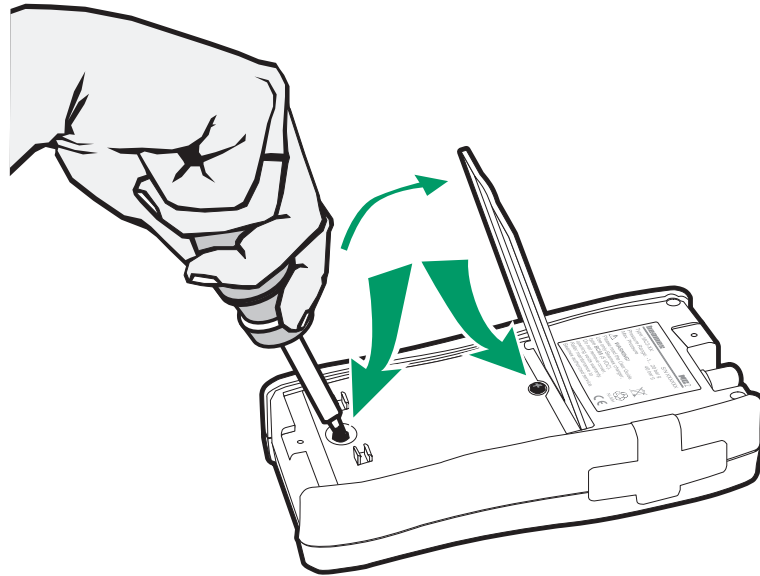

1. Turn MC2 upside down (the display facing the table top) and lift the support.
2. Unscrew the two screws holding the cover (see the picture above).
3. Bend the clip holding the battery pack connector and gently pull the connector out.
4. To replace the battery pack, click the connector of the new battery pack on its place (noting the polarity) and put the battery pack in its slot.

Note.

See also chapter **Capacity Indication** on page 14.

Capacity Indication

If you reset the calibrator or remove/replace the battery pack, "teach" the capacity of the batteries to the calibrator's charging electronics by doing as follows:

1. Fully charge the batteries (approx. 5 hours with no extra load).
2. Connect the current generation terminals to the current measurement terminals as shown in the adjacent picture.
3. Configure Window 1 to measure current with supply on. See also note below.
4. Configure Window 2 to generate (sink) 8 mA. The user interface should look as in the adjacent picture.
5. **Do not use the backlight.**
6. Let the calibrator fully discharge its batteries. This is the stage where the charging electronics "learn" the capacity of the battery pack.
7. When the calibrator shuts itself automatically, the learning is done.
8. Recharge the batteries and start using the calibrator

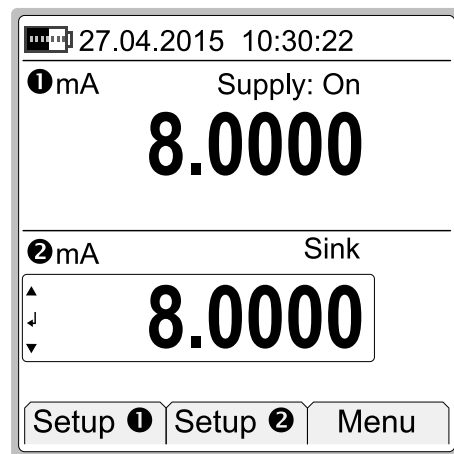
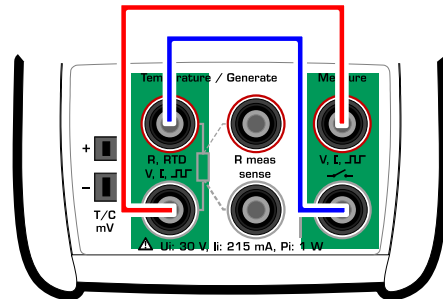

Note.

See part B for more detailed information on connections and configuring Window 1 and 2.

Hint.

If the calibrator's capacity indication has gotten mixed up, use the following method to reset the capacity indication:

Fully discharge the batteries as presented above. Then start recharging and immediately select **F3/Menu, Calibrator Adjustment** and enter **1590** as the "password". This resets the capacity indication to 0 %.

Then "teach" the capacity of the batteries using the instructions above again.

Similarly, the "password" **1599** sets the capacity to 100 %, if needed.

PC Communication with USB

The first time you connect MC2 to a computer (using the USB cable delivered with MC2), Windows' **Found New Hardware Wizard** initializes wanting to install a device driver.

The driver can be found at Beamex's web site (<http://www.beamex.com>). Look for MC2/MC2-IS/MC4 downloads. The driver is part of the software update package.

Notes.

The driver has been tested on Windows XP, Windows 2000, Windows Vista and in Windows 7, 32 and 64 bit versions.

Windows 95, 98, NT4, ME operating systems are not supported.

See also possible additional information delivered with the driver.

This procedure is needed when connecting MC2-IS for the first time to a particular USB port in a PC. After the driver is installed, communication initializes automatically, if MC2-IS is connected to the same USB port in a PC.

MC2 Firmware

MC2's firmware is saved in FLASH memory. Therefore it is relatively easy to update the firmware whenever a new version with fresh capabilities is released. See **Firmware Update** on page 32 for more information on updating the firmware in your MC2.

General Description

The following chapters briefly describe each main function.

Startup Procedure

When starting MC2 the startup procedure ends up in a welcome screen. From there it proceeds to Basic Mode and you are ready to start using the calibrator.

A more comprehensive description of the Startup Procedure is in the beginning of Part B of this manual.

Basic Mode and Higher Level Functions

In Basic Mode you can measure, generate and simulate signals. There are two separately configurable windows available.

All main functions of Basic Mode are described in part B of this manual.

Part C concentrates on higher level functions and additional information.

Calibration related information is available in Part D of this manual.

Basic Mode's User Interface

The main elements of the Basic Mode can be seen in the following picture:

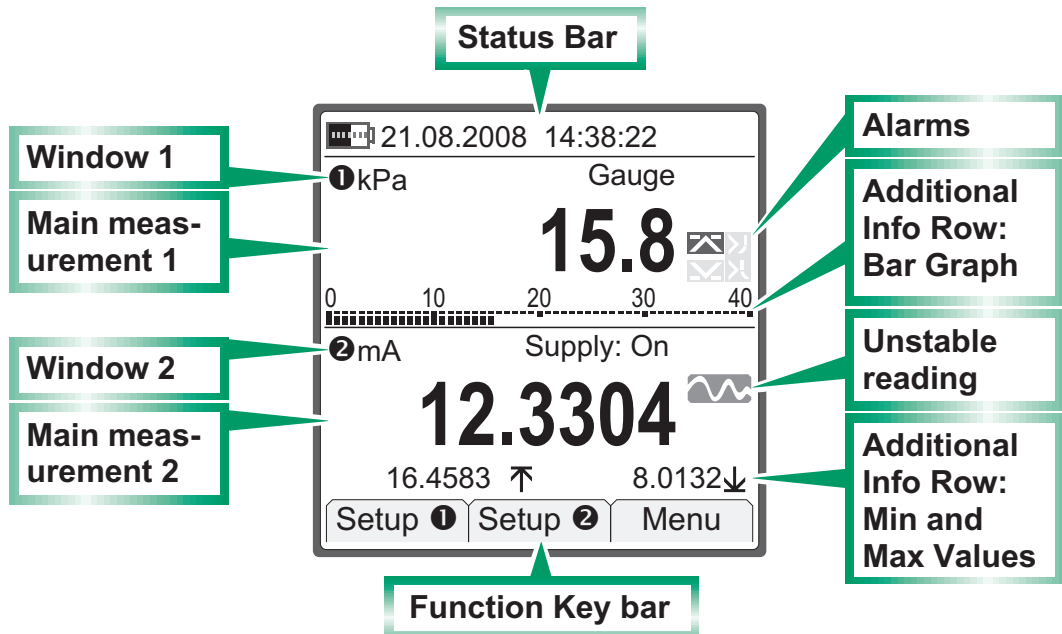

Other elements can be found in other windows. They are presented in the subsequent chapters.

The Status Bar

The Status Bar at the top of the display is divided into two sections.

The first (leftmost) section displays the charge level of the battery and a plug symbol when the charger/battery eliminator is connected. The second section displays the date and the third the time.

Windows 1 and 2

MC2 has two windows in Basic Mode. Both windows can independently be configured to display a measurement value. They can also be assigned to more data on the extra info row as seen in the previous picture.

Part of the window is reserved for alarm symbols as well as an unstable reading symbol (i.e. the measured value is not steady at the moment).

The Function Key Bar

The Function Key Bar at the bottom of the display is visible all the time. The meaning of the Function Keys varies depending on the situation. A grayed Function Key text means that the function is disabled at the moment.

Menu

The Function Keys often open menus, i.e. lists of available items.

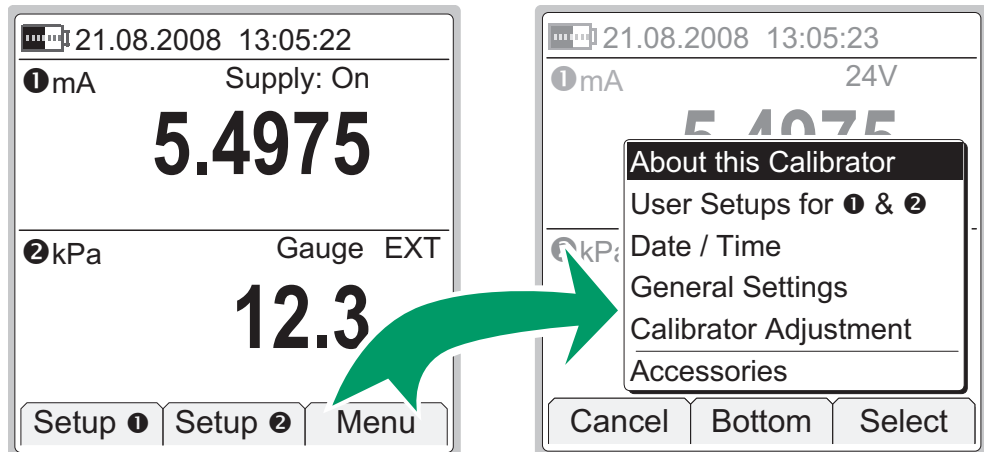

The pair of screenshots above is an example of an opening menu. This one opens from Basic Mode when F3 Function Key is pressed.

A menu with a longer list has small arrows at the top/bottom of the list to point out that the list is longer than what is shown.

Use the arrow keys (▼ and ▲) to move between menu options. The F2 Function Key helps you to scroll longer menu list. It allows you to quickly jump to the end (**Bottom**) and beginning (**Top**) depending on where in the list you are.

Select an item with the Enter key (↵) or use the F3/**Select** Function Key. Selecting a menu option results in one of the following events:

1. The menu closes and a window opens for viewing additional information or for configuring the selected task. This happens, e.g. when selecting the **About MC2** menu option in the picture above.
2. A tick is added/removed from the selected menu item. It means that the menu item is selected/deselected for a duty. This happens, e.g. when selecting which items are to be shown on the Additional Info row.
3. A sub menu opens allowing you to select one of available sub menu items.

Configuration Windows

There are several types of configuration windows. The examples below contain a selection of user editable fields.

The image shows two configuration windows side-by-side. The left window is titled "DATE / TIME" and contains a "Date Format" dropdown menu set to "dd.mm.yyyy", with fields for "day" (10), "month" (8), and "year" (2004). Below it is a "Time Format" dropdown menu set to "hh.mm.ss 24h", with fields for "hour (24h)" (12), "min" (15), and "sec" (22). An "Ok" button is at the bottom right. The right window is titled "ALARMS" and shows a gauge reading "0.06" for "kPa". It has a checked checkbox for "Alarms Active". Under "Alert when the measurement", there are two options: "> 1.500" (checked) and "< 0.100" (unchecked). Under "Alert when the rate of change", there are three buttons: "Stop", "Capture", and "Ok".

The view of the date/time configuration window contains selection lists and numeric fields.

The view of the alarms configuration window contains check boxes and numeric fields.

Descriptions of all field types are presented in the subsequent chapters.

Field Types Available for Editing Data

Use the arrow keys (▲ and ▼) to move between fields. Start and stop editing a field with the Enter key (↵).

Fields typically have three modes:

1. The field is displayed, but the cursor is **not highlighting** that particular field.
2. The cursor **is highlighting** a field.
3. The field is in **edit mode**.

All field presentations include a list of how the field looks in different states. Some fields do not exactly follow the above mentioned list of states. The differences are described where applicable.

Numeric Fields

	Numeric Field
Not highlighted:	<input type="text" value="10"/>
Highlighted:	<input style="background-color: black; color: white;" type="text" value="10"/>
Edit Mode:	<input style="border: 1px solid black;" type="text" value="15"/>

Beside the Enter key (↵), all Numeric keys sets the highlighted Numeric field to edit mode. The Enter key leaves the previous number available for editing and the Numeric keys replace the old value.

During edit mode, you can use the arrow keys (▲ and ▼), the **F3/Clear** and **F2/ ←** (= backspace) Function Keys to edit the field.

Accept the new value by pressing the Enter key (↵). To discard changes, use the **F1/Cancel** Function Key. See also Part B for special features concerning numeric fields when generating a signal.

Notes.

Certain numeric fields have an extra tool for inserting a value: When the field is highlighted, an **F2/Capture** Function Key appears. This allows you to capture and save the measured value in the Numeric field.

Numeric field used for generating/simulating signals include additional editing possibilities: **Spinning** and **Manual Stepping**. More of them in part B, **page 55**.

Text Fields

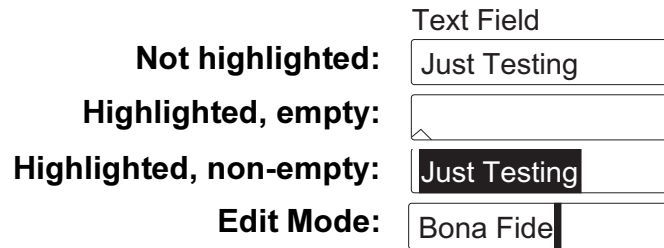

Beside the Enter key (↵), all Numeric keys set the highlighted Text field to edit mode. The Enter key leaves the previous text available for editing and the Numeric keys replace the old text.

During edit mode, you can use the arrow keys (⬆ and ⬇) and F2/ ⬅ (= backspace) Function Key to edit the field.

Use numeric keys to add characters. Adding characters is done as follows:

- First keypress opens a list of available characters with the first item highlighted.
- Repeated keypresses alter the highlighted characters.
- Press the Enter key (↵) or the F3/**Select** Function Key to select a character. Additional functionality while the list of available characters is open:
 - If no key is pressed for a certain time, the **Automatic Adding** utility selects the highlighted character (not used in the list of symbols opening from the decimal key).
 - Pressing F3/**Cancel** closes the list of available characters and no character is selected.

The F3/**Menu** Function Key allows you to do the following tasks:

- Select whether the added characters are: **Upper Case**, **Lower Case** or **Numbers**.
- Select whether the **Automatic Adding** of characters is: **Fast** or **Slow**.
- **Clear** the field.
- **Ok** for accepting the edited text.

Accept the new text by pressing the Enter key (↵) or use the previously mentioned menu option. To discard changes, use the F1/**Cancel** Function Key.

Selection Lists

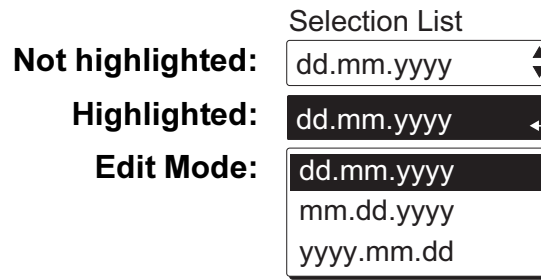

The Enter key (↵) changes a selection list to edit mode. A list of available options appear. If the list can not display all available items at the same time (not enough room), the list has small arrows at the top/bottom. This indicates that the list is longer than what is shown.

Use the arrow keys (▲ and ▼) to move between options. The F2 Function Key helps you to scroll longer menu list. It allows you to quickly jump to the end (**Bottom**) and beginning (**Top**) depending on where in the list you are.

Select one of the options with either the Enter key (↵) or the F3/**Select** Function Key. To discard changes, use the F1/**Cancel** Function Key.

Some of the selection lists have "favorites" i.e. recently selected items are moved to the top of the list. This feature is typically available in longer lists.

Hint.

To quickly jump to an option, use the Numeric keys. The first press jumps to the closest option starting with the first letter stated above the Numeric key. Repeated key presses jump to options starting with subsequent letters stated above the Numeric key.





Check Boxes

Highlighted: Check Box

Checked:

Unchecked:

A check box has no edit mode. Once it is highlighted (thicker borders), the value of the check box can be altered using one of the following possibilities:

- The Enter key () toggles the value of the check box.
- The Sign key () also toggles the value of the check box.
- The Zero key () clears the check box.
- The One key () sets the check box.

MC2's Modularity and Options

MC2 includes optional hardware modules. This makes it possible to buy a calibrator with capabilities according your requirements.

Hardware Modules/Options

Internal Pressure Module (IPM)

Available gauge pressure modules:

- IPM200mC, range: ± 200 mbar (± 80 iwc)
- IPM2C, range: -1 ... +2 bar (-14.5 ... 30 psi)
- IPM20C, range: -1... +20 bar (-14.5 ... 300 psi)
- IPM160, range: 0... 160 bar (0 ... 2400 psi)

MC2 may include one of the above mentioned internal pressure modules and additionally an internal barometric module.

Optional Dry Battery Cartridge

Enables use of AA size dry batteries instead of the standard rechargeable NiMH pack accessory.

Optional Pressure T-hose

Hose set for connecting an instrument to be calibrated, a pressure source and MC2.

Optional Soft Carrying Case

MC2's soft carrying case is practical when moving between locations. The carrying case can also be used for transporting utilities, like:

- Test hoses, test leads and clips
- External Pressure Module
- A pressure pump
- Charger and its cable

The carrying case is suited for use in normal industrial environment.

Optional Connection Cable For External Pressure Modules (EXT)

Needed when connecting External Pressure Modules (EXT) to MC2.

Optional Thermocouple Mini Plugs

For connecting thermocouples to MC2's T/C, mV connector.

Other Devices

There is an increasing number of devices that can be used together with MC2. The following list includes devices that are already available (valid when this manual was printed):



- External Pressure Modules (EXT)
- Calibration hand pumps:
 - **PGV** vacuum pump,
 - **PGM** high pressure pump and
 - **PGXH** extra high pressure pump

Safety

The materials of MC2's case withstand normal industrial conditions. MC2 endures shocks with the help of the built in impact protectors

Symbols Used

The following symbols concerning electrical safety are used in MC2.

	Alternating current, AC
	Direct current, DC
	Caution! See manual for further information

Safety Precautions and Warnings

MC2 calibrator is a precision calibration tool that should be used by skilled people who have read and understood this User Guide. Working with MC2 involves the usage of pressure and/or electrical instruments. Be sure to know how to work with these instruments and how to safely connect/disconnect pressure hoses as well as electrical test leads clips, etc.

Use MC2 only if you are certain of that it can be used safely. Safe use of MC2 is no longer possible if one or more of the following cases are true:

- When the case of MC2 is evidently damaged
- When MC2 is not functioning as expected
- After prolonged storage in unfavorable conditions
- After serious damage during transport

Sometimes it is necessary to use a portable radio transceiver while working with the calibrator. To prevent calibration errors caused by the radio frequency interference, keep the radio far (at least 1 meter) from the calibrator and the circuit under calibration while sending.

General Warnings

Do not use MC2 in any other way than as described in this User Guide.

Use the MC2's battery charger in a non-hazardous indoor location only and only with Beamex MC2 calibrators. While charging, the temperature should not exceed 35 °C (95 °F). If MC2's battery charger is broken, dispose it according to local waste regulations and order a new charger from Beamex. Do not connect a broken charger to MC2.

MC2 uses a rechargeable Battery Pack or alkaline batteries. All of these battery types are considered as hazardous waste. Dispose used batteries properly according to local regulations.

Avoid short circuiting the batteries. The short circuit current may cause burns to you, damage to the device or even fire. Notice, that also new replacement batteries are shipped in charged state.

Rechargeable batteries may vent small amounts of gas during recharge. The vented gas mixture may be highly explosive, but normally it diffuses rapidly into the atmosphere. To avoid danger, use only the original charger and never recharge in a gas-tight container.

Warnings Concerning Electrical Measurement and Generation

The measurement and generation terminals of MC2 are protected against over voltage and over current as far as it has been possible without affecting the accuracy. Do not however connect signals that are above the measurement range of the selected Function.

There is no galvanic isolation between the connectors on the left side, the internal pressure module connector and the terminals of the Temperature/Generate section.

Although there is a galvanic isolation between MC2's Measure and Temperature/Generate sections, it is for functional purposes only. Do not exceed 60 VDC / 30 VAC / 100 mA between any terminal.

Maximum output voltage from MC2's terminals is below 30 V. If you, however, connect together voltages from the Measure and Temperature/Generate sections or if you connect external voltages to MC2, the resulting voltage may be high enough to be hazardous.

General Warnings Concerning Pressure Measurement

The optional pressure T-hose is rated to the maximum pressure of 20 bar at 21°C (290 psi at 70°F). Applying higher pressure can be hazardous. We recommend the use of the optional pressure hose set. When using other hoses and connectors, make sure they are high quality products that withstand the used pressure.

To avoid damaging the calibrator, use hand tightening only (max. torque 5 Nm) when connecting the pressure measurement hose to the internal pressure module. If the use of tools is required to secure the connection (typically an internal pressure module with a pressure range of 20 bar / 300 psi), apply the counterforce with a spanner on the connector body's hexagonal part.

Always depressurize the system before opening or connecting any pressure fittings or connectors. Use proper valves for venting the system. Ensure that all connections are made correctly and that the hose and the connectors are intact.

The allowed pressure media for internal pressure modules is inert, non-toxic, non-explosive media. External modules have the allowed media printed on the module's sticker. Using unsuitable pressure media may destroy the pressure module/calibrator.

External Pressure Modules: Use only the pressure media stated on the pressure module. Use of wrong type of Pressure Media may destroy the pressure module.

Never exceed the maximum pressure of a pressure module. The internal pressure module's maximum pressure is stated on calibrator's sticker. The maximum pressure of external modules is stated on module's sticker and mentioned in the Instruction Booklet that is provided with the external module.

Never plug a hose with your hands or put hands in front of a gas spray coming from a leakage. A gas bubble in the blood circulation can cause death.

Warnings Concerning High Pressure

High pressure is always dangerous. Only personnel with good experience and knowledge of high pressure liquid, air and nitrogen operations are allowed to work with the module. Read carefully all these instructions and local safety instructions for high pressure operations before starting the use.

When using gas, the system must not contain any liquid, especially if you do not know how they may react under pressure. Use of clean air or nitrogen is recommended as gaseous pressure media. Liquid pressure media should be preferred when using modules with a pressure range of 60 bar (30000 psi) or more.

If you use nitrogen, minimize the leak to the atmosphere and take care of sufficient ventilation. Close the valve of the nitrogen cylinder, when the system is not in use. Increase in the percentage of nitrogen in the ambient air may cause unconsciousness and death without warning. Read carefully the safety instructions for nitrogen and make sure that the other people in the same space are aware of the danger.

Use of liquid pressure medium is recommended with pressure measurement modules at higher pressure range. Use water or suitable hydraulic oil. Check that the used liquid is not aggressive against the materials used in the transducer or tubing. When using liquid, minimize the amount of air in the system. So you can minimize the amount of spilled liquid in case of leakage.

Do not use the same tubing with different liquids or gases.

Check what the local regulations say about construction and use of pressurized vessels. The regulations normally control construction and use of systems where the product of the pressure and volume exceeds a certain limit. The volume of this system depends on the instrument connected to it.

High pressure gas is dangerous because it can break the container and the flying splinters may cause injury. Also small leaks of gas may be dangerous because the high velocity of the leaking gas jet enables penetration through skin. If a gas bubble gets into the blood circulation, it can cause death. The leak jet is particularly penetrative, if some liquid is coming with the gas.

Disposal of Waste Electrical and Electronic Equipment

Beamex is an environmentally conscious company developing products with a view to ensure that they are easy to recycle and do not introduce hazardous materials into the environment.

In the European Union (EU) and other countries with separate collection systems, waste from electrical and electronic equipment (WEEE) is subject to regulations.

EU WEEE Directive 2002/96/EC (the WEEE Directive) requires that producers of electronic equipment are responsible for the collection, reuse, recycling and treatment of WEEE which the Producer places on the EU market after August 13, 2005. The objective of this regulation is to preserve, protect and improve the quality of the environment, protect human health, and conserve natural resources.



The symbol on the left is also printed on the product's sticker. It indicates that this product should be handed over to applicable collection point for the recycling of electrical and electronic equipment.

For more detailed information about recycling of this product, please contact your local representative or your waste disposal service.

Service

Only qualified service personnel may perform higher level maintenance for MC2. **Never open the case unless have explicit instructions from Beamex or a local representative.**

There are, however a few things that anyone using MC2 may do.

Firmware Update

The quickest way to see if a new firmware version is available is checking out Beamex's web site (<http://www.beamex.com>). Go to the "Downloads" page and see what it says about MC2 firmware versions and downloads.

All you need is a Personal Computer and the Computer communication cable that connects MC2 to one of the USB ports in your PC. For USB driver info, see chapter **PC Communication with USB** on page 15 of this manual.

Also check for possible release notes accompanying the updated file.

The Battery Charger

The charger is not intended to be serviced. When unusable it can be thrown away according to local waste disposal regulations.

Resetting MC2

Sometimes you may want to reset the calibrator. To do that, press and hold the Enter key (↵) and the On/Off key (⏻) for 5 seconds. Then press the On/Off key again.

Recalibrating MC2

See Appendix 2 for instructions on how to recalibrate MC2.

Cleaning MC2

If MC2 needs cleaning, use cloth soaked with a mild solution of tall oil soap (pine soap). Wait a few minutes and then clean using a cloth moistened with pure water. Never use any strong detergents.

(Empty)

Startup and Basic Operation

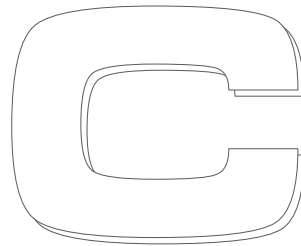
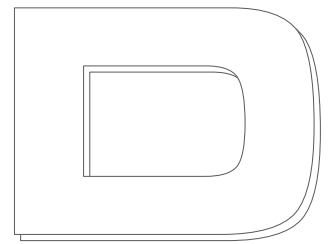

Things discussed in Part B:

- What happens during the startup procedure.
- Measuring signals.
- Generating/simulating signals.
- Presenting the utilities available in a window's Tools menu.

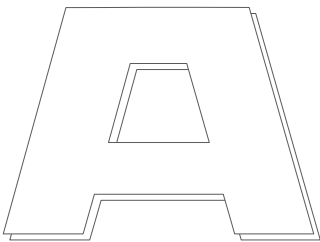

Starting MC2

Startup Procedure

The duration of MC2's startup procedure depend on the time since the latest shutdown as well as the type and charge level of the batteries. For short shutdown periods MC2 stays in "sleep mode" and the welcome screen opens almost immediately. If the shutdown lasts longer, MC2's startup begins with a system check-up.

The welcome screen presents some basic information of the calibrator at hand.

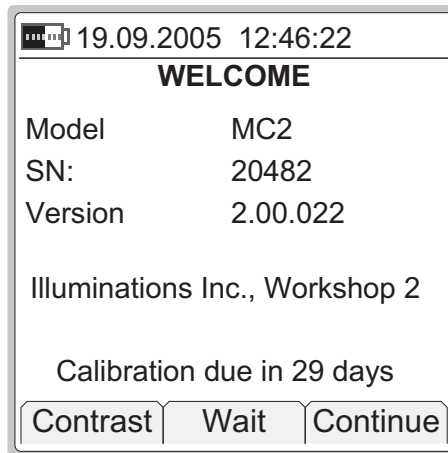

If you want to view the calibrator information for a longer period, press the **F2/Wait** Function Key. Then the calibrator information is visible until you press the **F3/Continue** Function Key.

The lowermost row displays the days until (or since) MC2's due date for recalibration. If the calibration is overdue, or in the near future, MC2 stops at the welcome screen to remind you of the need for recalibration. Otherwise it continues to Basic Mode after a while (or when you press the **F3/Continue** Function Key).

Basic Mode, Defined

All measurements/generations/simulations are performed in the Basic Mode. When returning from MC2's higher level operations (e.g. calibrator and window configurations), you always return to the Basic Mode.

In Basic Mode, the two available measurement/generation/simulation windows have default settings based either on factory settings or settings defined when MC2 was previously used.

The Function keys at the bottom of the window allow you to change the settings of the two windows or open a menu for higher level operations etc.

Below is an example picture of a Basic Mode screen with the following settings.

Window ❶:

- Pressure measurement using an external pressure module.
- Minimum and maximum value display on the additional info row.
- High limit alarm in use, but not active (⚡).
- Low limit alarm in use and active (☑).

Window ❷:

- Current measurement using MC2's 24 V power supply .
- Bar graph active on the on the additional info row.

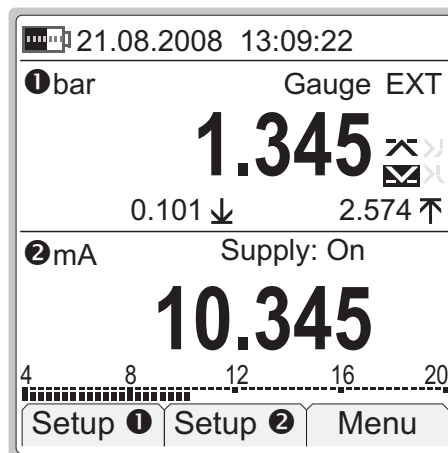

What can be done in Basic Mode

- Measure signals (*)
- Generate signals (*)
- Simulate signals (*)
- Set alarm limits
- Start special measurements (min/max value etc.)
- Use the ramping function
- Use the stepping function

*) Available options depend on the installed modules.

Next...

Measuring on page 39

Generating/Simulating on page 54

Tools Menu on page 67

Alarms on page 69

Measuring

All MC2 models are capable to perform the following measurement functions:

- Current measurement
- Frequency measurement
- Pressure measurement
(model MC2-TE with an external pressure module)
- Pulse counting
- Switch state sensing
- Voltage measurement

Additionally, with models MC2-MF and MC2-TE:

- Resistance measurement
- RTD temperature measurement
- T/C temperature measurement

To start measuring a certain quantity, configure one of the Basic State's windows (select **F1/Setup ①** or **F2/Setup ②**). Use the Enter key to open to the list of **Functions** (uppermost field in the configuration window) and select what you want to measure. All other fields refine the measurement characteristics.

When presenting measurements in this manual, the first paragraph describes the measurement, the MC2 model(s) capable of performing the measurement followed by the **Function** setting needed to start that measurement.

Notes.

In this manual, MC2's measurement **Functions** are presented in alphabetic order. The order the **Functions** appear on your MC2 depends on which **Functions** have been used most recently.

A **Function** or a set of **Functions** using the same terminals can not be selected for several windows simultaneously. MC2 limits the list of available Functions based on functions already in use. To free terminals, select **No Function** for appropriate window.

Measurement settings including all alarms and other special measurements may be saved and retrieved. Use the utility found in the **F3/Menu** Function Key for saving and retrieving settings. This is described in Part C of this manual.

Read the warnings found in part A of this manual

Current Measurement

MC2 supports current measurement using either MC2 as the loop power supply while at the same time measuring the current or simply measuring the current while an external power supply is used. All MC2 models are capable of measuring current.

Function: **Current Meas., Supply On** or **Current Meas., Supply Off**

Also check the **HART Compatible Loop Supply** setting if you use MC2 as the power supply. When the option is checked, MC2 adds a suitable impedance to the loop to ensure HART communication.

Make sure the polarity of your connections is correct. The following four pictures present the correct connections for different MC2 models and also for different ways of providing the supply power to the loop.

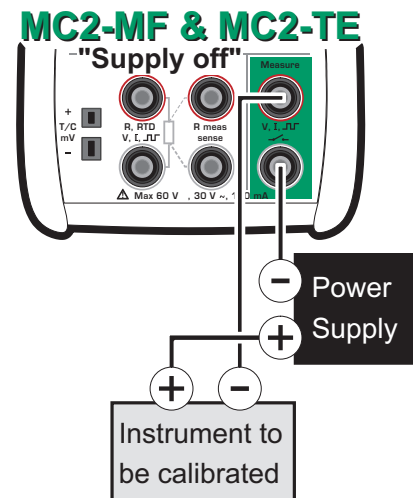
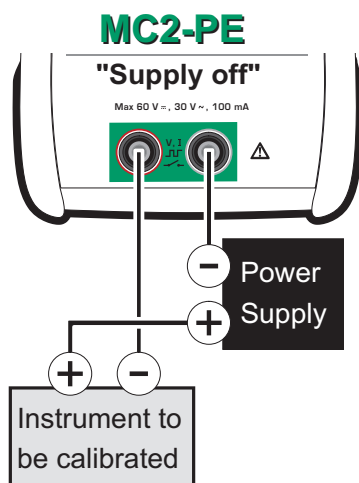
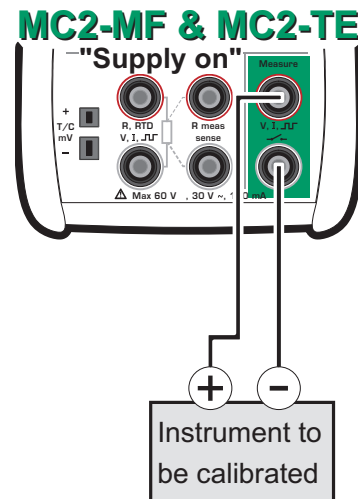
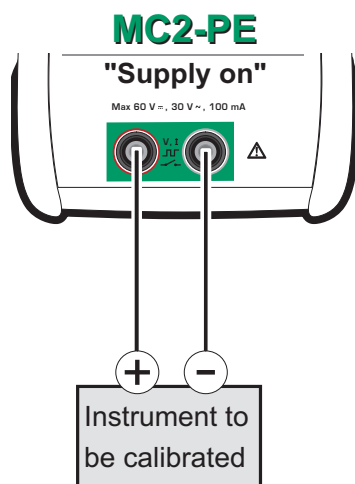

Information concerning current measurement parallel to a test diode can be found in part C, chapter **Current Measurement Parallel to a Test Diode, Connections** on page 118.

Next...

Current Generation on page 57.

Tools Menu on page 67.

Alarms on page 69.

Calibration, see Part D.

Frequency Measurement

MC2 measures frequencies between 0.0027 Hz (10 cph) to 50 kHz. All MC2 models are capable of measuring frequencies.

Function: **Frequency Measurement**

Also check the **Trigger Level** setting. There you can specify the trigger level and whether to use a test voltage during the frequency measurement.

The frequency measurement terminals for each MC2 model are highlighted in the pictures below.

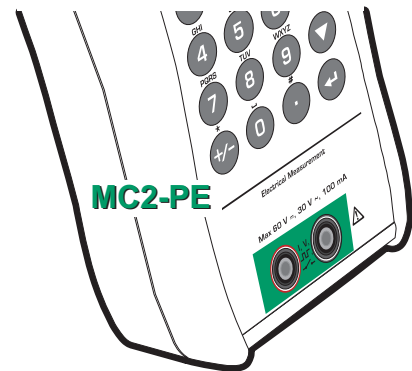
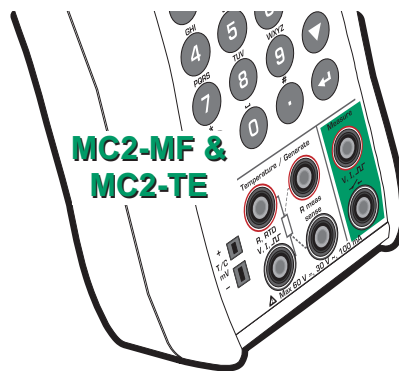

Next...

Frequency Generation on page 59

Switch State Sensing on page 49

Pulse Counting on page 47

Calibration, see Part D.

Pressure Measurement

MC2-PE and MC2-MF are capable of pressure measurement using their internal pressure module. Additionally, all MC2 models may be used for measuring pressure using a suitable external pressure module connected to the EXT connector.

MC2 supports the use of an internal pressure module (if installed). When connecting an external pressure module to MC2 (any model), it is automatically detected and there is a possibility to immediately put the connected external pressure module to use.

Function: **Pressure Internal**,
Pressure External or,
Internal Barometer

Also check the **Pressure Type** setting. If an internal or external barometer is present, the pressure measurement of any gauge module may also be displayed as absolute pressure. For more information concerning pressure types, see chapter **Pressure Type** on page 108.

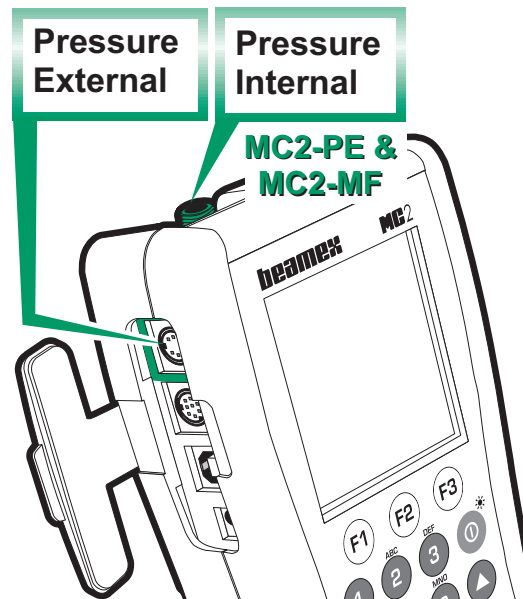

Notes.

For more information on pressure measurement and internal/external pressure modules, see chapter **Things to Consider when Measuring Pressure** on page 108.

For information on creating custom pressure units, see Part C, chapter **Custom Pressure Units** on page 106.

When using high pressure modules, you may measure pseudo absolute pressure. Open the setup window (select **F1/Setup ①** or **F2/Setup ②**), change the pressure type to absolute. Then an extra field for entering the barometric pressure appears. Enter the barometric pressure manually and press **F3/Ok**. MC2 adds the manually entered barometric pressure to the measured gauge pressure and displays the (pseudo) absolute pressure.

Connecting and Disconnecting External Pressure Modules

An external pressure module may be connected and disconnected at any time. If a removed module was part of an active measurement, MC2 emits a "bleep" to inform you of the fact that the external pressure module used for pressure measurement was removed. The window where the external pressure measurement was configured reverts to "None/No Function". This happens even if the external pressure module was used as the secondary measurement in a special measurement.

External Barometric Module Specifics

If MC2 includes an internal barometric pressure module and an external barometric module is connected, the following rules apply:

- **For most cases:** When the external barometric module is connected to MC2, it supersedes the internal barometric module.
- **Exception:** If the internal barometric module is used in conjunction with a gauge module (Pressure Type is **Absolute**) and the external barometric module is connected, then MC2 continues to use the internal barometric during that measurement session.
- **Disconnecting:** When the external barometric module is removed, any measurements utilizing it are stopped. Restarting the measurement takes the (possible) internal barometric module in use.

Zeroing a Pressure Module

If the selected pressure module does not display zero gauge pressure when the applied pressure is zero, the module has to be zeroed.

Open the appropriate window setup menu (**F1/Setup ①** or **F2/Setup ②**) and select **F1/Zero Pressure**. If a secondary pressure module is active in the selected window (see **Tools Menu** on page 67), a pop-up menu will appear for choosing either to zero the primary or the secondary pressure module.

NOTE!

Zeroing a pressure module is especially important when the operating position of MC2 is changed or the location of MC2 is changed in the vertical direction. Both of the above mentioned factors affect notably on the pressure measurement modules. Measuring pressure below 100 mbar (approx. 40 iwc) should be done with a firmly mounted MC2 (e.g. placed on a table top).

Next...

Tools Menu on page 67

Alarms on page 69

Calibration, see Part D.

Pulse Counting

All MC2 models are capable of counting pulses.

Function: **Pulse Counting**

Check the **Trigger Level** setting to specify the trigger level and whether to use a test voltage during the pulse counting. Also check the **Trigger Edge (Rising or Falling)** setting so it suits your need.

The pulse counting terminals for each MC2 model are highlighted in the pictures below.

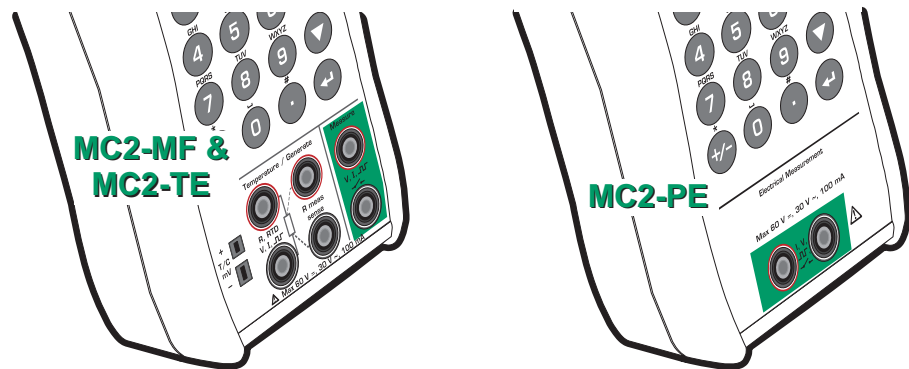

The counter may be cleared (zeroed) by selecting **F1/Setup 1** or **F2/Setup 2** (depending on which window is used for pulse counting) and **F1/Clear Pulses**.

Next...

Pulse Generation on page 60
Frequency Generation on page 59
Frequency Measurement on page 43
Switch State Sensing on page 49
Calibration, see Part D.

Resistance Measurement

MC2-MF and MC2-TE are capable of measuring resistance.

Function: **Resistance Measurement**

The following picture displays the active terminals:

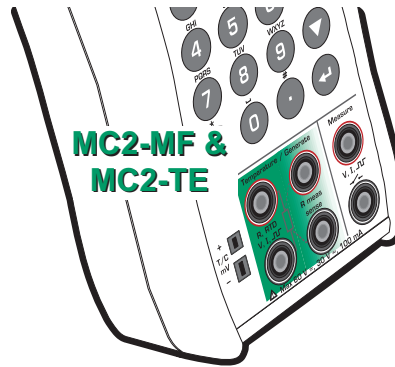

The two leftmost terminals are used in 2-wire systems. MC2 automatically checks the connection and displays the found wiring system (2-wire, 3-wire or 4-wire) in the upper right corner of the measuring window. For more information concerning wiring options, see **Resistance and RTD Measurement, Connections** on page 116.

Note.

If the measured resistance value is infinite or very high (> 4000 ohm), the text "+OVER" is displayed in the measuring window. This means that the circuit is broken or the connection is wrong. Wrong connection may also cause erroneous reading, typically too low. If necessary, use the 2-wire ohm measurement to check the wiring before final connection.

Next...

Resistance Simulation on page 61

Temperature Measurement (RTD) on page 51

Tools Menu on page 67

Alarms on page 69

Calibration, see Part D.

Switch State Sensing

MC2 is capable of detecting switch's state both when the switch is free of external potential or switches with DC voltages within the range -1 V to +30 V. See the pictures below for the location of the active terminals, depending on the model at hand.

Function: **Switch**

Also check the **Trigger Level** setting. There you can specify whether to use only a trigger voltage level or do you also want MC2 to include a test voltage to detect switches with no external potential. All voltages below the trigger level are treated as a closed contact and all voltages above the trigger level are treated as an open contact.

The following picture displays the active terminals:

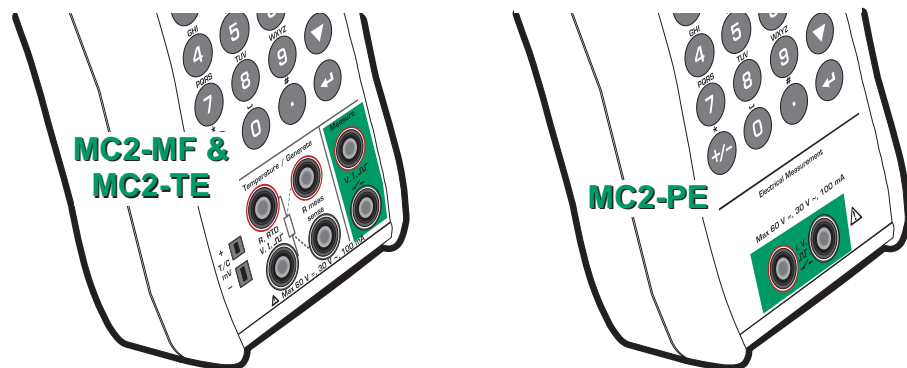

When switch state sensing is selected, the extra row info of the window with the switch function is capturing measurement values of the other window every time the switch changes its state. In the adjoining screen shot, the switch's current state is "open" (the big switch symbol). The last time the switch opened, the pressure was 3.058 bar and the last time the switch closed, the pressure was 1.983 bar.

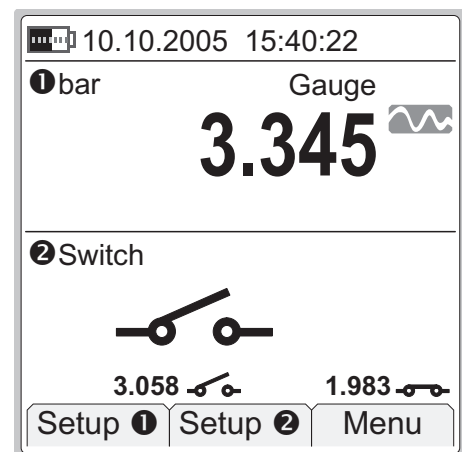

Notes.

The accuracies of the captured values depend greatly on the change rate of the switch's input signal.

Hint!

Switch state detection may also be used for binary signal detection. An open switch equals "1" or **true** and a closed switch equals "0" or **false**.

Use Switch Sound field to assign an "alarm" to a switch. Then you can use switch test for conductivity/continuity tests with no need to look at the display.

You can invert the switch's open/closed state indication using the check box available in the measurement window's setup window. This can be used to show real switch state when switch state sensing is connected to relay coil instead of relay contacts.

Next...

Tools Menu on page 67

Alarms on page 69

Calibration, see Part D.

Temperature Measurement (RTD)

MC2-MF and MC2-TE are capable of RTD temperature measurement.

Function: **RTD Sensor Measurement**

Also check the **Sensor** setting. Make sure you select the same sensor type than what is connected to MC2. Otherwise your measurement results are unreliable.

The picture below displays the active terminals.

The two leftmost terminals are used in 2-wire systems. MC2 automatically checks the connection and displays the found wiring system (2-wire, 3-wire or 4-wire) in the upper right corner of the measuring window.

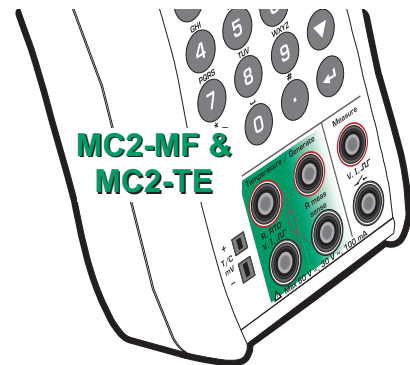

For more information concerning wiring options, see **Resistance and RTD Measurement, Connections** on page 116.

By default the additional info row at the bottom of the window displays the measured RTD resistance. More of additional info row on page 90.

Note.

If the measured resistance value is infinite or very high (> 4000 ohm), the text "+OVER" is displayed in the measuring window. This means that the circuit is broken or the connection is wrong. Wrong connection may also cause erroneous reading, typically too low. If necessary, use the 2-wire ohm measurement to check the wiring before final connection.

Next...

RTD Sensor Simulation on page 62

Resistance Simulation on page 61

Temperature Measurement (Thermocouple) on page 52

Resistance Measurement on page 48

Tools Menu on page 67

Alarms on page 69

Calibration, see Part D.

Temperature Measurement (Thermocouple)

MC2-MF and MC2-TE are capable of thermocouple temperature measurement..

Function: **T/C Sensor Measurement**

Make sure a **temperature unit** is selected from the **Unit** list. Otherwise the measurement displays voltages, not temperatures.

Check the **Sensor** setting. Make sure you select the same sensor type than what is connected to MC2. Otherwise your measurement results are unreliable.

Also select a suitable Reference Junction compensation method from the **RJ Mode** list. Wrong reference junction setting results in useless measurement results.

Additional information about Reference Junction compensation methods can be found in chapters **Internal Reference Junction** on page 111 and **External Reference Junction** on page 112.

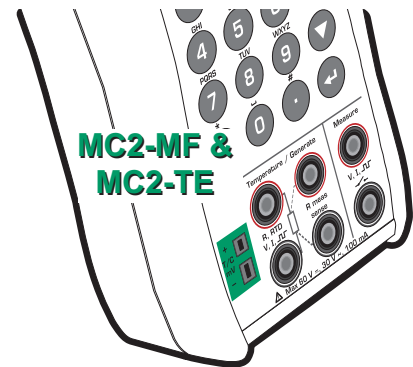

The adjacent picture displays the active terminals:

By default the additional info row at the bottom of the window displays either the thermovoltage corresponding to Reference Junction temperature 0 °C (when **Unit** field is set to temperature) or the thermovoltage with Reference Junction compensation taken into account (when **Unit** field is set to "Voltage + RJ"). In both cases also the Reference Junction temperature is shown. More of additional info row on page 90.

Warning!

If you connect an RTD sensor to the RTD connectors, there is no galvanic isolation between the thermocouple and the RTD sensor.

Next...

- Thermocouple Simulation** on page 64
- Temperature Measurement (RTD)** on page 51
- Voltage Measurement** on page 53
- Tools Menu** on page 67
- Alarms** on page 69
- Calibration**, see Part D.

Problems with thermovoltage measurement? See **Error situations** on page 115.

Voltage Measurement

MC2 is able to measure voltages. However, the available measurement ranges and connection terminals vary depending on the model at hand.

Measurement range: 1 to +60 VDC

Function: **Voltage Measurement**

This measurement range is available in all MC2 models.

The active terminals for this measurement range are highlighted in the two pictures below.

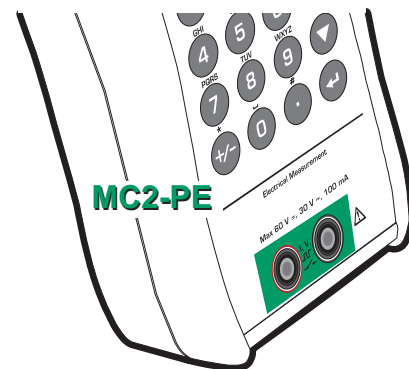
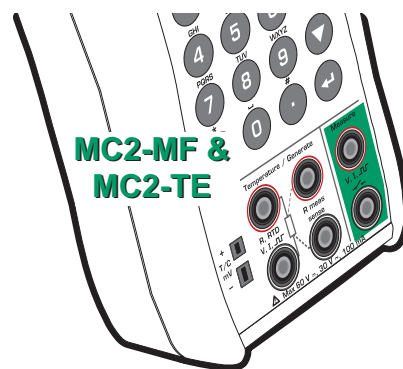

Measurement range: -25 to 150 mVDC

Function: **Low-Voltage
Measurement**

This measurement range is available in MC2-MF and MC2-TE.

The active terminals for this measurement range are highlighted in the adjacent picture.

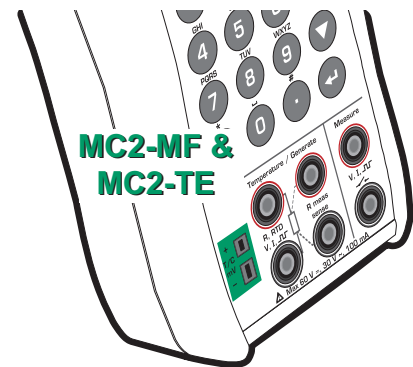

Warning!

Do not apply hazardous voltages to MC2's terminals.

Next...

Voltage Generation on page 66.

Temperature Measurement (Thermocouple) on page 52.

Tools Menu on page 67.

Alarms on page 69.

Calibration, see Part D.

Generating/Simulating

MC2 models MC2-MF and MC2-TE are capable to perform the following generation/simulation functions:

- Current generation (source or sink)
- Frequency generation
- Pulse generation
- Resistance simulation
- RTD sensor simulation
- Thermocouple simulation
- Voltage generation

Note that MC2-PE is not capable of generating, only measuring signals.

To start generating/simulating a certain quantity, configure one of the Basic State's windows (select **F1/Setup 1** or **F2/Setup 2**). Use the Enter key to open to the list of **Functions** (uppermost field in the configuration window) and select what you want to generate/simulate. All other fields refine the generation/simulation characteristics.

When presenting generations/simulations in this manual, the first paragraph describes the generation/simulation, the MC2 model(s) capable of performing the generation/simulation followed by the **Function** setting needed to start the generation/simulation.

Notes.

In this manual, MC2's generation/simulation Functions are presented in alphabetic order. The order the Functions appear on your MC2 depends on which Functions have been used most recently.

A Function or a set of Functions using the same terminals can not be selected for several windows simultaneously. MC2 limits the list of available Functions based on Functions already in use. To free terminals, select **No Function** for appropriate window.

Read the warnings found in part A of this manual.

Changing the Generated/Simulated Value

The simplest way of changing a generated/simulated value is entering a new value using the numeric keys. Finish entering the new value by pressing the Enter (↵) key.

When entering the value, the Function Keys allow you to clear the value (F3), remove a character to the left of the cursor (F2) or cancel the entering of a new value (F1).

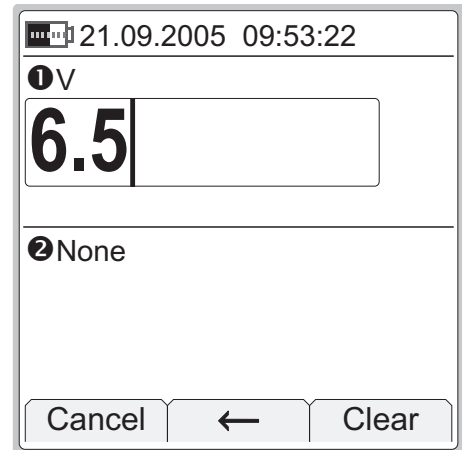

Spinning and Manual Stepping

Spinning and Manual Stepping are two easily available methods for changing the generated/simulated value.

To start **Spinning**, press the Enter (↵) key when generating/simulating and viewing the Basic Mode windows. Then one of the generation/simulation digits is inverted.

To spin the inverted digit, use the up and down arrow keys (▲ ▼). To change the digit to be spun, press either (F1) or (F3) Function Key.

To stop spinning, press the Enter (↵) key.

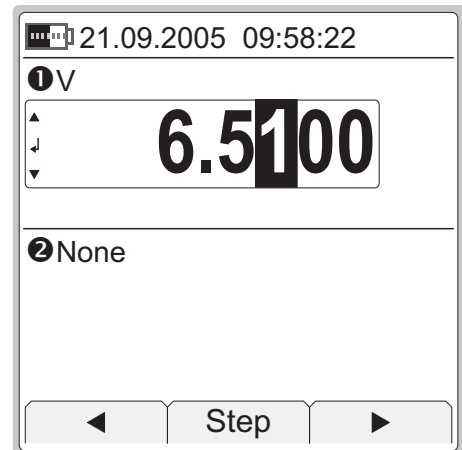

Manual Stepping is an additional functionality available while Spinning.

To start Manual Stepping, you first need to start the Spinning utility and then press the F2/Step Function Key.

To step through the defined steps, use the up and down arrow keys (▲ ▼). To toggle between the minimum and maximum value, press the (F2) Function Key.

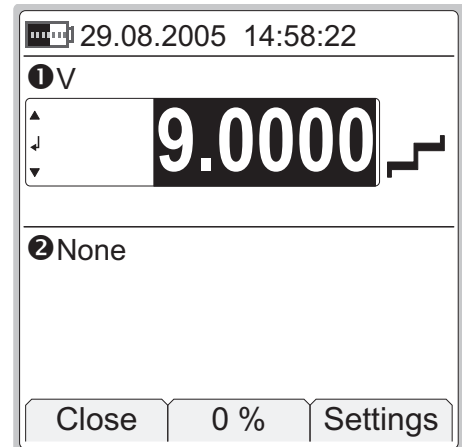

Function Key F3 opens a **Manual Step** configuration window. Its functionality is described in chapter **Manual Stepping** on page 78.

To stop Stepping and return to Spinning, press the Enter (↵) key. To stop Stepping and return to Basic Mode, press the **F1/Close** Function Key.

Notes.

You cannot exceed the minimum/maximum limits of a Function when Spinning/Stepping.

The spinned/stepped value follows the resolution properties of the generated/simulated Function.

MC2 remembers the Manual Step configuration settings for each generation/simulation Function.

Current Generation

MC2 is able to generate current both in source and sink mode. In source mode MC2 provides the supply power to the loop. In sink mode an external power supply is used and MC2 controls the current flow. MC2-MF and MC2-TE are capable of generating current.

Function: **Current Source or Sink**

The connection of the current loop varies depending on the setting of the **External Supply, Sink Current (reverse polarity)** check box. See the following pictures.

Source mode:

External Supply, Sink Current (reverse polarity)

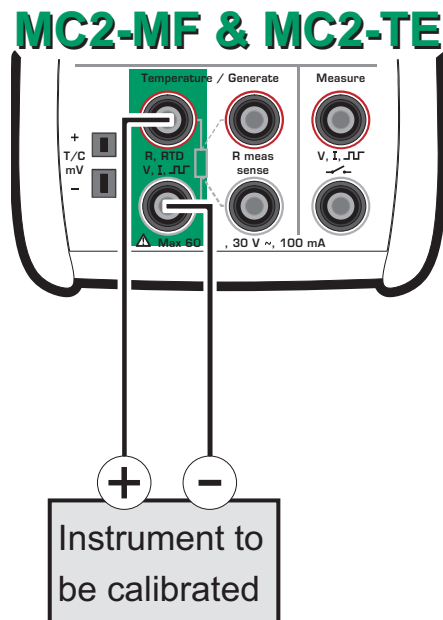

Sink mode:

External Supply, Sink Current (reverse polarity)

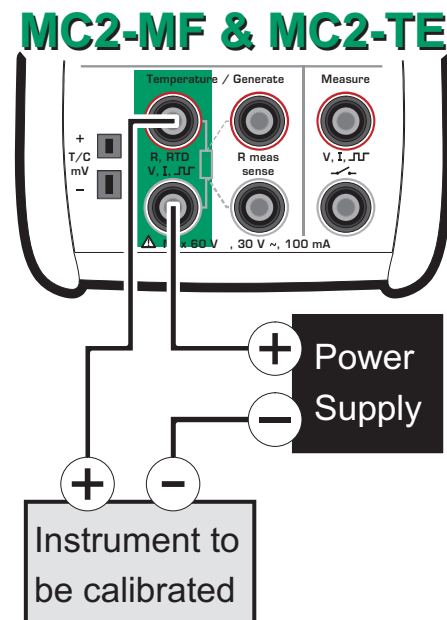

Note.

If the loop resistance of the external circuit is too high or infinite, the message "**Overload**" is displayed until the load is reasonable.

Warnings!

Make sure that you don't exceed the maximum current allowed by the instrument under test.

If you open the current generation loop, MC2 tries to maintain the current by increasing the output voltage. If you then close the loop again, the current is first too high, but returns quickly to the correct level. If this current peak could damage the components of the loop, make sure that the loop will not open or protect it against overcurrent. For the same reason, always enter 0 mA output before connecting the loop.

Next...

Current Measurement on page 41.

Tools Menu on page 67.

Stepping on page 73

Ramping on page 76.

Calibration, see Part D.

Frequency Generation

MC2-MF and MC2-TE are able to generate frequencies. The frequency is either a symmetric or a positive square wave.

Function: **Frequency Generation**

Check the **Waveform** setting. The percentage value is the **Duty Cycle** setting (the ratio of the output high time to the total cycle time). Also check the **Amplitude** setting.

The adjacent picture displays the active terminals:

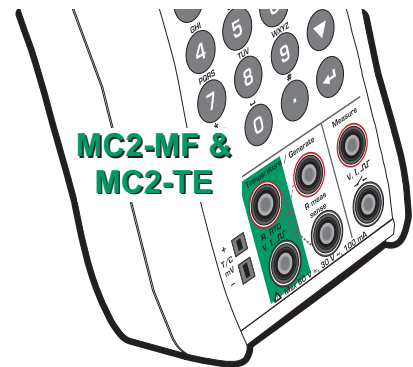

Note.

Due to technical reasons, the entered Duty Cycle setting is not always realized. This happens with relatively high and low frequencies. The true Duty Cycle percentage is shown in the appropriate Basic Mode window.

See **Appendix 1, Technical Data** for more specific info of Duty Cycle limitations.

Next...

Pulse Generation on page 60.

Frequency Measurement on page 43.

Tools Menu on page 67.

Stepping on page 73

Ramping on page 76.

Calibration, see Part D.

Pulse Generation

MC2-MF and MC2-TE are able to generate pulses. The pulses are either symmetric or positive square waves.

Function: **Pulse Generation**

The Repetition Frequency (Hz) setting defines the frequency to be used when generating the pulses.

The **Waveform** and **Amplitude** settings are similar to the settings found in **Frequency Generation** on page 59.

The adjacent picture displays the active terminals:

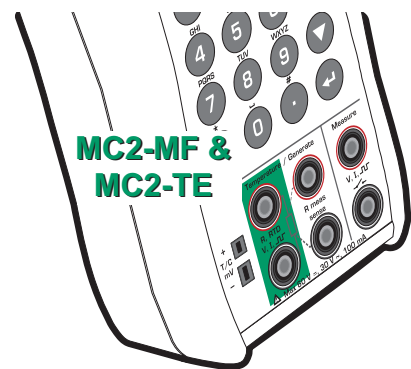

In the Basic Mode window:

Enter the amount of pulses MC2 should generate. The pulse generation starts immediately after the amount is entered.

By default the additional info row at the bottom of the window displays pulses done and pulses left (icons: ↗ and ↘ respectively). More of additional info row on page 90.

Note.

Due to technical reasons, the entered Duty Cycle setting is not always realized. This happens with relatively high and low frequencies. The true Duty Cycle percentage is shown in the appropriate Basic Mode window.

See **Appendix 1, Technical Data** for more specific info of Duty Cycle limitations.

Next...

Frequency Generation on page 59.

Pulse Counting on page 47.

Tools Menu on page 67.

Stepping on page 73

Ramping on page 76.

Calibration, see Part D.

Resistance Simulation

In resistance simulation MC2 mimics a resistor. The instrument under test generates the current for the resistance measurement. MC2 controls the voltage across its terminals so that the resistance (voltage to current ratio) corresponds to the resistance. MC2-MF and MC2-TE are capable of RTD resistance simulation.

Function: **Resistance Simulation**

The correct resistance value is between the resistance simulation terminals of the calibrator. Use of 2-, 3- or 4-wire connection is up to the receiver instrument. Use only the two leftmost R, RTD terminals with every wiring option. Connect the possible third and fourth wire according to the requirements of the connected instrument, but use only the two leftmost R, RTD terminals.

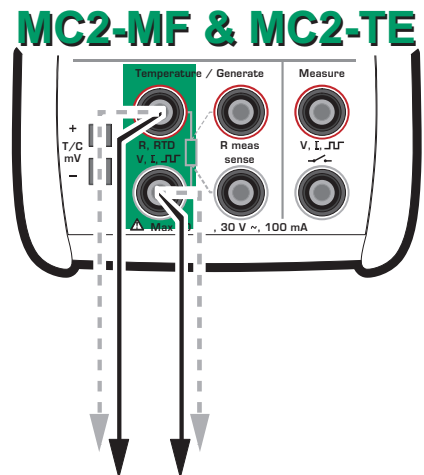

Notes.

In resistance simulation MC2 monitors the resistance measurement current. If the current is too high, it cannot simulate the right resistance value. In that case it shows the message "**High Cur**".

Accurate operation of the simulation electronics requires that the current supplied by the instrument under test does not vary rapidly. The simulation result is not accurate if the instrument under test uses AC current. If the instrument under test uses pulsed measurement current, it should wait a few milliseconds before starting the measurement after setting the current.

Next...

Resistance Measurement on page 48.

RTD Sensor Simulation on page 62.

Tools Menu on page 67.

Stepping on page 73

Ramping on page 76.

Calibration, see Part D.

RTD Sensor Simulation

In RTD sensor simulation MC2 mimics an RTD. The instrument under test generates the current for the RTD measurement. MC2 controls the voltage across its terminals so that the resistance (voltage to current ratio) corresponds to the simulated temperature. MC2-MF and MC2-TE are capable of RTD sensor simulation.

Function: **RTD Sensor Simulation**

Also check the **Sensor** setting. Make sure you select the same sensor type than the connected instrument requires. Otherwise your simulation is useless.

The correct resistance value is between the resistance simulation terminals of the calibrator. Use of 2-, 3- or 4-wire connection is up to the receiver instrument. Use only the two leftmost R, RTD terminals with every wiring option. Connect the possible third and fourth wire according to the requirements of the connected instrument, but use only the two leftmost R, RTD terminals.

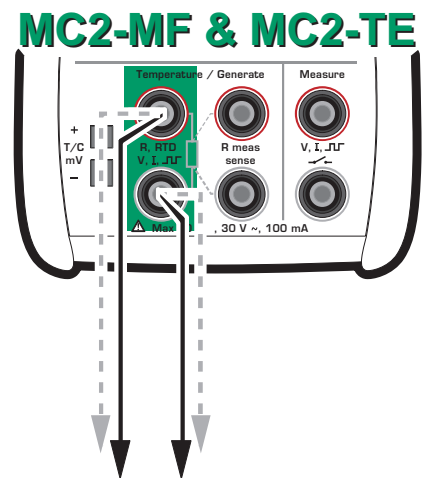

By default the additional info row at the bottom of the window displays the resistance MC2 is simulating while performing RTD simulation. More of additional info row on page 90.

Notes.

In RTD simulation MC2 monitors the resistance measurement current. If the current is too high, it cannot simulate the right resistance value. In that case it shows the message "**High Cur**".

Accurate operation of the simulation electronics requires that the current supplied by the instrument under test does not vary rapidly. The simulation result is not accurate if the instrument under test uses AC current. If the instrument under test uses pulsed measurement current, it should wait a few milliseconds before starting the measurement after setting the current.

Next...

Temperature Measurement (RTD) on page 51.

Thermocouple Simulation on page 64.

Resistance Simulation on page 61.

Tools Menu on page 67.

Stepping on page 73

Ramping on page 76.

Calibration, see Part D.

Thermocouple Simulation

In thermocouple simulation the original thermocouple is disconnected from the instrument under test and replaced with MC2. MC2 mimics a thermocouple at given temperatures. To the instrument under test MC2 appears as a thermocouple at the given temperature. MC2-MF and MC2-TE are capable of thermocouple simulation.

Function: **T/C Sensor Simulation**

Check the **Sensor** setting. Make sure you select the same sensor type than what is required by the instrument under test. Otherwise your measurement results are unreliable.

Also select a suitable Reference Junction compensation method from the **RJ Mode** list. Wrong reference junction setting results in useless measurement results. Additional information about Reference Junction compensation methods can be found in chapters **Internal Reference Junction** on page 111 and **External Reference Junction** on page 112.

The adjacent picture displays the active terminals:

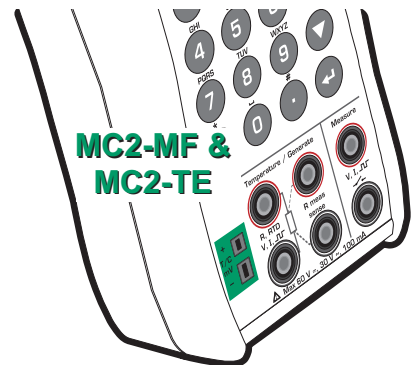

By default the additional info row at the bottom of the window displays either the thermovoltage corresponding to Reference Junction temperature 0 °C (when **Unit** field is set to temperature) or the thermovoltage with Reference Junction compensation taken into account (when **Unit** field is set to "Voltage + RJ"). In both cases also the Reference Junction temperature is shown. More of additional info row on page 90.

Notes.

If the resistance of the external circuit in thermocouple simulation is very low (obvious short circuit), the message "**Overload**" is displayed until the load is reasonable.

If the thermocouple to be simulated is not available MC2's sensor list, select one of the "**Voltage + Reference Junction**" units and convert from temperature to millivolts manually. Also select a thermocouple type from the **Sensor** list that approximately matches your sensor (in used Reference Junction range). This allows MC2 to perform Reference Junction compensation as accurately as possible. In this situation, the accuracy depends on the similarity of the selected sensor in MC2 and the used sensor.

Wire-wound thermocouple temperature indicators and recorders are calibrated with known loop resistance, commonly ten or twenty ohms. The required resistance of the conductors is usually marked on the device. When calibrating such a device, tune the loop resistance to the nominal value with an additional resistor.

Use MC2's 2-wire resistance measurement to tune the loop resistance of a wire wound device. Short circuit the measuring device for the time of resistance measurement. The resistance measurement may damage the device, if you do not install the short circuit. For more information on resistance measurement, see chapter **Resistance Measurement** on page 48.

Warnings!

If you short circuit the thermocouple simulation output, MC2 tries to maintain the voltage by increasing the output current. If you then open the output again, the voltage is first too high, but returns quickly to the correct level. If this voltage peak could damage the components of the circuit, make sure that the circuit can not be shorted or protect the circuit against overvoltage. For the same reason, always enter 0°C output before connecting the circuit.

If you connect an RTD sensor to the R, RTD connectors, there is no galvanic isolation between the thermocouple and the RTD sensor.

Next...

Temperature Measurement (Thermocouple) on page 52.

RTD Sensor Simulation on page 62.

Tools Menu on page 67.

Stepping on page 73

Ramping on page 76.

Calibration, see Part D.

Problems with thermovoltage simulation? See **Error situations** on page 115.

Voltage Generation

MC2-MF and MC2-TE are capable of voltage generation. They both have two voltage generation ranges as presented here.

Generation range: -3 to 12 V

Function: **Voltage Generation**

The active terminals for this generation range are highlighted in the adjacent picture.

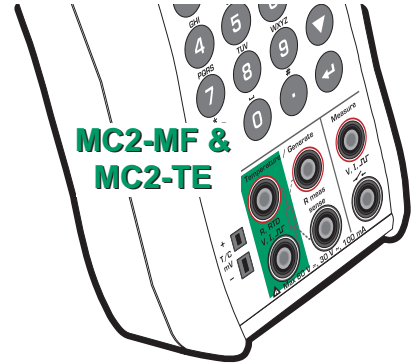

Generation range: -25 to 150 mV

Function: **Low-Voltage Generation**

The active terminals for this generation range are highlighted in the adjacent picture.

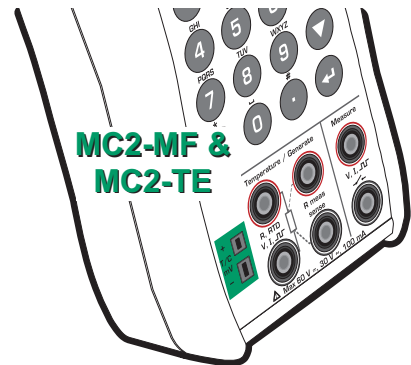

Warning!

If you short circuit the voltage output, MC2 tries to maintain the voltage by increasing the output current. If you then remove the short circuit, the voltage is first too high, but returns quickly to the correct level. If this voltage peak could damage the components of the circuit, make sure that the circuit can not be shorted or protect the circuit against over voltage. For the same reason, always enter 0 V output before connecting the circuit.

Next...

- Voltage Measurement** on page 53.
- Thermocouple Simulation** on page 64.
- Tools Menu** on page 67.
- Stepping** on page 73
- Ramping** on page 76.
- Calibration**, see Part D.

Tools Menu

MC2's Basic Mode windows have utilities that add extra features to your measurements/generation/simulations. They are available in a window's **Tools** menu. The contents of the **Tools** menu varies depending on which function is selected. This is because measurement functions require different tools than generation/simulation functions.

Tools menu for a measurement Function:

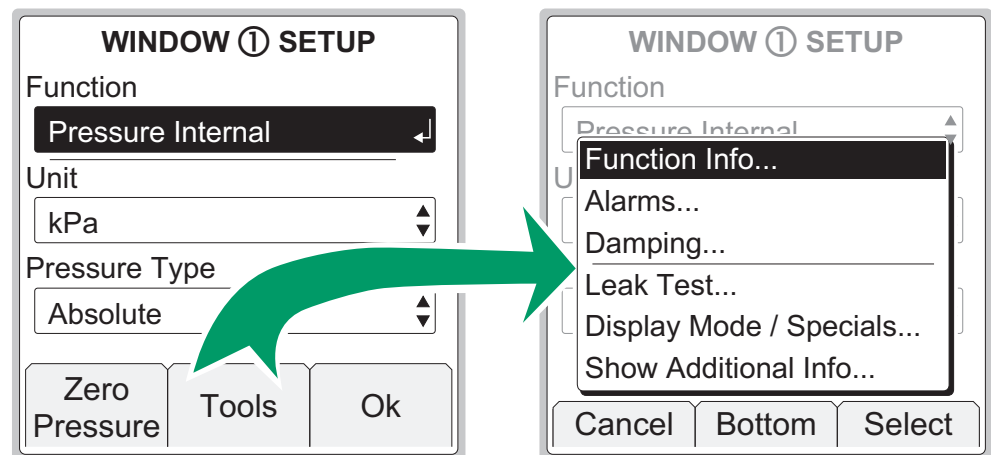

Tools menu for a generation/simulation Function:

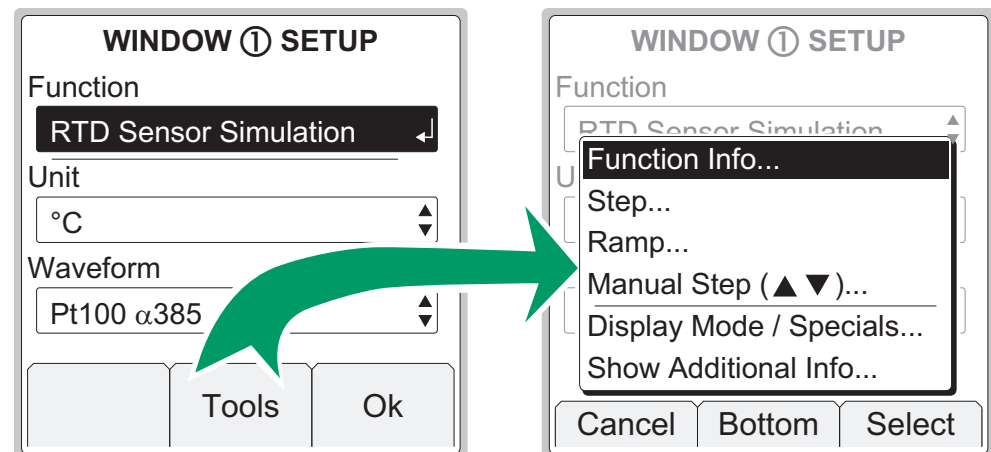

The following subchapters present each utility available in the **Tools** menu.

Function Info

Function Info option is always available in the **Tools** menu.

This option is "enhancing your measurement" by presenting some useful information of the selected quantity, e.g. the measurement range and calibration info. Function Info is divided into two pages. Use **F2/More** Function Key to move from page to page.

To see Function Info, enter the following menu commands: **F1/Setup ①** or **F2/Setup ②** (depending on which window you want to view Function Info for), **F2/Tools** and **Function Info** from the opened menu.

Alarms

Each main measurement in a window may have alarm limit settings. MC2 supports "higher than", "lower than", "high rate" and "low rate" alarms.

To set the alarm limits, enter the following menu commands: **F1/Setup ①** or **F2/Setup ②** (depending on which window you want to configure alarms to), **F2/Tools** and **Alarms** from the opened menu.

Make sure the **Alarms Active** field is checked. Then the other settings are available. Table of alarm symbols used:

⤴	High alarm limit
⤵	Low alarm limit
⤶	High change rate alarm limit
⤷	Low change rate alarm limit

Individual alarm limit values may also be activated/deactivated using the check box preceding the alarm limit value. The alarms chosen for use are shown in the measurement window using the same symbols as in the table above.

When an alarm limit is exceeded, MC2 emits an audible alarm and the alarm symbol is shown with inverted colors. To acknowledge the alarm, open the window's setup window and from here the **Tools** menu. Just below the menu's Alarm option is an item that is shown only when alarms are activated: Acknowledge this Alarm. The active alarm limit is inverted in the measurement window as long as the alarm limit is exceeded.

Note.

Rate alarm limits are not "symmetrical". E.g. high rate alarm 0.5 bar/min emits an alarm when the pressure increases faster than the limit but does not emit an alarm when the pressure decreases faster than -0.5 bar/min.

Hint.

If you want to set an alarm that utilizes the change rate alarm limit but don't know which limit value to use, display the change rate on the additional info row (see chapter **Display Mode and Special Measurements** on page 81). Observe what happens to the change rate during the event that needs an alarm. Then set the change rate alarm limit accordingly.

Acknowledging Alarms

When an alarm is active, the Tools menu of the window with the active alarm includes an option to acknowledge alarms.

Resetting Alarms and Alarm Limits

To stop using alarm limits, uncheck the **Alarms Active** field.

To stop using and clear all alarm limits, select another Function or reselect the same Function.

Damping

Damping is useful when a measurement signal contains unwanted noise. MC2 includes a set of damping tools.

To set the damping value, enter the following menu commands: **F1/Setup ①** or **F2/Setup ②** (depending on which window you want to configure damping to), **F2/Tools** and **Damping** from the opened menu. The damping settings apply to all main and secondary measurements active in the window when damping was started.

About the filtering options:

Average filters the data using the average of recent measurements.

Adaptive average uses the measurement's change rate to choose the amount of recent measurements used in the average calculation.

The next group of options are 1st order digital filters with a damping time as stated in their names.

Leak/Stability Test

Leak/stability test is a tool for testing the leak or stability of, e.g. a pressure measurement system. Generally: the test tells you both the absolute and the average change per minute of any measurement during the test period.

To open the test window, enter the following menu commands: **F1/Setup ①** or **F2/Setup ②** (depending on which window you want to configure the test to), **F2/Tools** and **Leak / Stability Test** from the opened menu.

See the leftmost picture below to see how the test window appears. The window where the test was invoked in is moved to top and enlarged to include the test data and the other window is minimized showing only the essential measurement data. Any data selected to be shown on the additional info row is temporarily hidden.

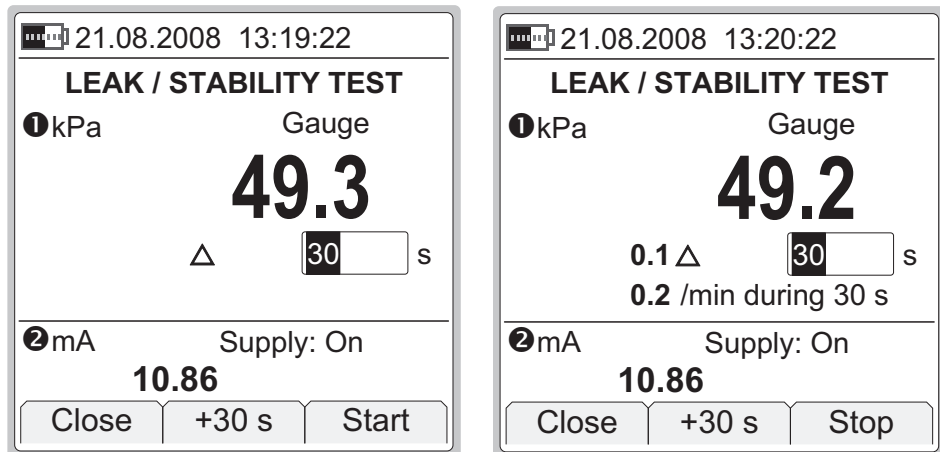

To start the test, first check the test time to be used. Either accept the default value or enter another time period in seconds. Entering zero as the test time means the test will continue until manually stopped. Select **F1/Start** and see how the test advances.

The rightmost picture above is an example of an MC2 display during a test. The absolute decrease is shown beside the triangle and the average decrease per minute below.

Notes.

You may increase the test time in 30 second steps using the **F2/+30 s** Function Key. This can be done both before the test is started and also while the test is in progress.

MC2 uses numbers that have more decimals than are available on the display. In some cases these extra digits may cause rounding that differs from values that are shown on display. Notable differences between shown and manually calculated values usually mean that MC2's accuracy is not suitable for the given task.

If applicable, disable MC2's auto-off functionality during the test. If the test lasts longer than the auto-off delay, MC2 is shut down while the test is still incomplete.

An external pressure module (EXT) connected to MC2 during a leak/stability test cannot be taken into use in the window where the leak/stability test is under progress.

Hint.

If you have a pressure transmitter connected to a pressure measurement system and you want to check the pressure decrease without altering the pressure connections, do as follows:
Connect the electrical output of the pressure transmitter to MC2. Use MC2's scaling utility to scale the output signal back to pressure units. Start the leak/stability test for the scaled measurement and there you can see the leak in pressure units. More info on scaling in chapter **Scaling** on page 86.

Stepping

Stepping utility is one of three tools allowing you to create generation/simulation signals that vary with time. This one could be called "automatic stepping" since one of the other tools is a manual stepping utility.

Other similar tools:

Ramping on page 76

Manual Stepping on page 78.

To open the stepping configuration window, enter the following menu commands: **F1/Setup ①** or **F2/Setup ②** (depending on which window you want to configure the stepping to), **F2/Tools** and **Step** from the opened menu.

The leftmost picture below shows the configuration window and the rightmost picture the stepping utility in use.

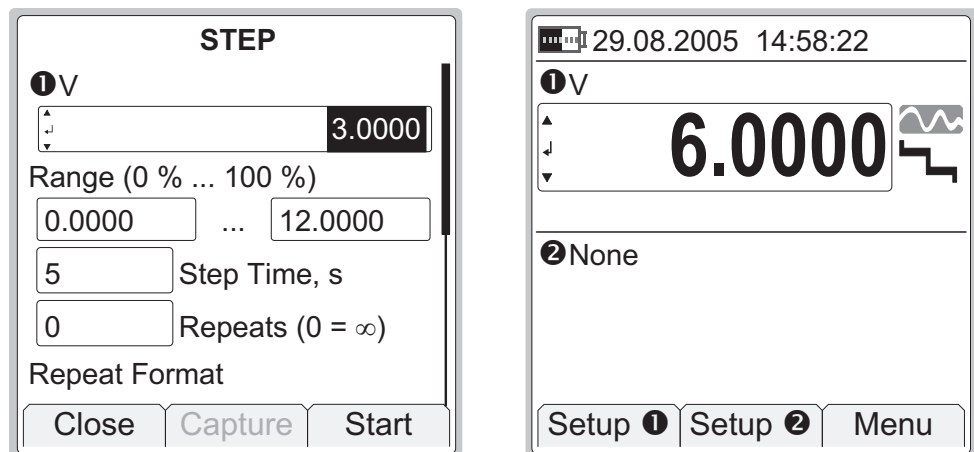

Start stepping by selecting the **F3/Start** Function Key in the configuration window. To stop a stepping that is in progress, open the stepping configuration window and press **F1/Stop Step** Function Key.

When stepping is ready, or stopped, you may restart it as follows: **F1/Setup ①** or **F2/Setup ②** (depending on which window you want to configure the stepping to), **F1/Start Step**. This possibility is available until a new Function is selected for the window where stepping was used or MC2 is shut down.

The following table presents the fields of the configuration window.

FIELD	DESCRIPTION/OPTIONS
Range[*]	The minimum and maximum value for the stepping range.
Step Time	Enter the time for a single step. Use only full seconds, no decimals.
Repeats	Defines how many times the steps are repeated. Value "zero" equals continuous stepping.
Repeat Format	How the stepping should be done. Available options: Up / Down Down / Up Up Down
Step Definition	<p>Defines how the stepping is done Available options (with no custom sets):</p> <p>By: 'Step Size' By: 'Number of Steps' 3: 50 % 5: 25 % 6: 20% 11: 10 % 0%>10>25>50>75>90>100 0%>2>4>50>96>98>100 0%>5>40>100 -2%>0>2>4>50>96>98>100>102 Create New...</p> <p>The two first options require additional data that is entered in the two following fields.</p> <p>The group of sets starting with a number and colon are sets with fixed step sizes. The first number is the amount of step levels and the percentage value is the step size.</p> <p>The group of sets starting with a number and percentage symbol are sets with varying step sizes (suitable for, e.g. valve tests). Each number is a step level. The last item in the list allows you to make your own custom step definition. Custom steps are presented in chapter Custom Test Point Sets on page 101.</p> <p style="text-align: right;"><i>Continues on next page...</i></p>

FIELD <i>(cont.)</i>	DESCRIPTION/OPTIONS
Step Size	Active only if Step Definition field is set to "By: 'Step Size'". If applicable, set the fixed step size here.
Number of Steps	Active only if Step Definition field is set to "By: 'Number of Steps'". If applicable, set the number of steps here.
Transfer Function	<p>Defines the input/output correlation. Available options:</p> <ul style="list-style-type: none"> Linear \sqrt{x} $\sqrt{x^3}$ $\sqrt{x^5}$ x2 Create New... <p>The last item in the list allows you to make your own custom Transfer Function. Custom Transfer Functions are presented in chapter Custom Transfer Functions on page 103.</p>

***)Warning!**

Do not configure the range settings so that they exceed the allowed input range of the connected instrument. MC2 determines the limits of the range settings based on the selected quantity and port, not the connected instrument.

Ramping

Ramping utility is one of three tools allowing you to create generation/simulation signals that vary with time.

Other similar tools:

Stepping on page 73

Manual Stepping on page 78

To open the ramping configuration window, enter the following menu commands: **F1/Setup 1** or **F2/Setup 2** (depending on which window you want to configure the ramping to), **F2/Tools** and **Ramp** from the opened menu. Note that ramping is available for generation/simulation Functions only.

The leftmost picture below shows the configuration window and the rightmost picture the ramping utility in use.

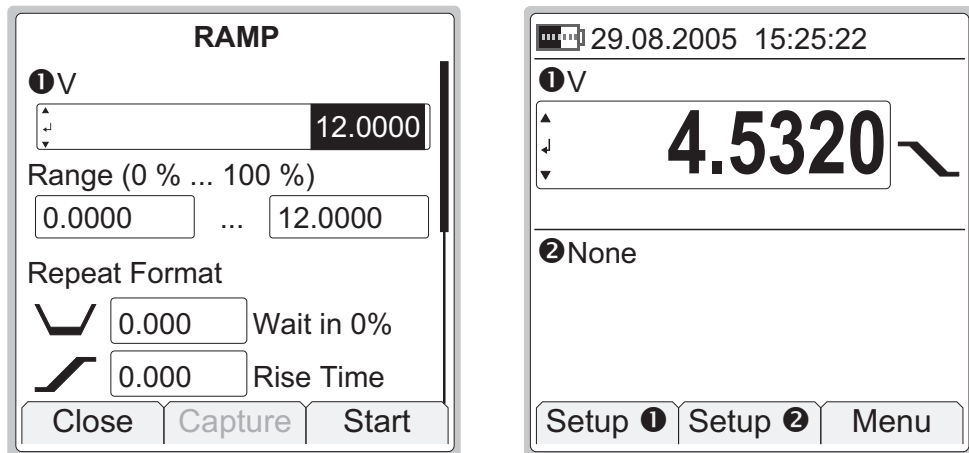

Start ramping by selecting the **F3/Start** Function Key in the configuration window. To stop a ramp that is in progress, open the ramping configuration window and press **F3/Stop** Function Key.

When ramping is ready, or stopped, you may restart it as follows: **F1/Setup 1** or **F2/Setup 2** (depending on which window you want to configure the ramping to), **F1/Start Ramp**. This possibility is available until a new Function is selected for the window where ramping was used or MC2 is shut down.

The following table presents the fields of the configuration window.

FIELD	DESCRIPTION/OPTIONS
Range^(*)	The minimum and maximum value for the ramping range.
Repeat Format Wait in 0% Rise Time Wait in 100% Fall Time	How the ramp should be carried out. Use only full seconds, no decimals.
Repeats	Defines how many times all four phases of the ramp are repeated. Value "zero" equals continuous ramping.

***)Warning!**

Do not configure the range settings so that they exceed the allowed input range of the connected instrument. MC2 determines the limits of the range settings based on the selected quantity and port, not the connected instrument.

Note.

MC2 actually makes the ramp in small steps. The steps are as small as possible, slower ramps use smaller steps.

Manual Stepping

Manual stepping differs from the other two tools allowing you to create varying generation/simulation signals in that the signal does not automatically change. Instead it advances according to the defined steps when you press the up or down arrow keys (▲ ▼), one step at a time.

Other similar tools:

Stepping on page 73

Ramping on page 76

To open the manual stepping configuration window, enter the following menu commands: **F1/Setup 1** or **F2/Setup 2** (depending on which window you want to configure the stepping to), **F2/Tools** and **Manual Stepping** from the opened menu. Note that manual stepping is available for generation/simulation Functions only.

The leftmost picture below shows the configuration window and the rightmost picture the stepping utility in use.

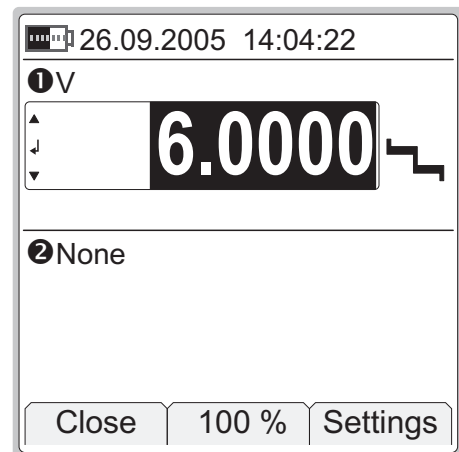
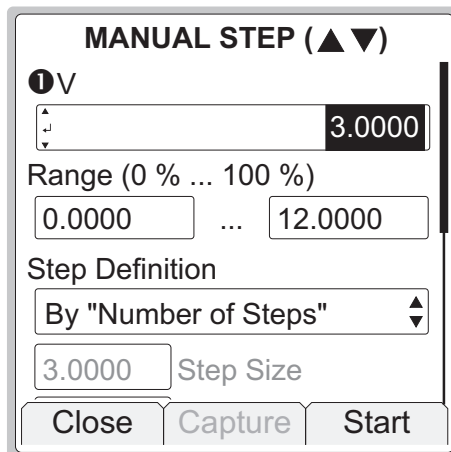

Start manual stepping by selecting the **F3/Start** Function Key in the configuration window. To stop it, press **F1/Close** Function Key (in Basic Mode).

The following table presents the fields of the configuration window.

FIELD	DESCRIPTION/OPTIONS
Range^(*)	The minimum and maximum value for the stepping range.
Step Definition	<p>Defines how the stepping is done Available options (with no custom sets):</p> <p>By 'Step Size' By 'Number of Steps'</p> <p>3: 50 % 5: 25 % 6: 20% 11: 10 %</p> <p>0%>10>25>50>75>90>100 0%>2>4>50>96>98>100 0%>5>40>100 -2%>0>2>4>50>96>98>100>102</p> <p>Create New...</p> <p>The two first options require additional data that is entered in the two following fields.</p> <p>The group of sets starting with a number and colon are sets with fixed step sizes. The first number is the amount of step levels and the percentage value is the step size.</p> <p>The group of sets starting with a number and percentage symbol are sets with varying step sizes (suitable for, e.g. valve tests). Each number is a step level. The last item in the list allows you to make your own custom step definition. See Custom Test Point Sets on page 101.</p>
Step Size	Active only if Step Definition field is set to "By: 'Step Size'". If applicable, set the fixed step size here.
Number of Steps	Active only if Step Definition field is set to "By: 'Number of Steps'". If applicable, set the number of steps here. <i>Continues on next page...</i>

FIELD <i>(cont.)</i>	DESCRIPTION/OPTIONS
<p>Transfer Function</p>	<p>Defines the input/output correlation. Available options:</p> <ul style="list-style-type: none"> Linear √x √x3 √x5 x2 Create New... <p>The last item in the list allows you to make your own custom Transfer Function. See Custom Transfer Functions on page 103.</p>

***)Warning!**

Do not configure the range settings so that they exceed the allowed input range of the connected instrument. MC2 determines the limits of the range settings based on the selected quantity and port, not the connected instrument.

See also:

Spinning and Manual Stepping on page 55.

Display Mode and Special Measurements

The Display Mode and Special Measurements utility is always available, but the available options vary depending on the selected Function.

All Display Mode settings are in: **F1/Setup ①** or **F2/Setup ②** (depending on which window you want to change the display mode for), **F2/Tools**. Select **Display Mode / Specials** from the opened menu.

When a Display Mode or a Special Measurement is active, the measurement window display a warning (⚠) to indicate that the reading is not the actual measured value. Depending on the selected Display Mode or Special Measurement, some additional text is also shown.

All Display Mode and Special Measurement settings revert to Normal display mode if you select another quantity. Additionally, the same menu were a Display Mode or a Special Measurement was invoked also includes a possibility to revert back to **Normal Display Mode**.

Note applying to all display modes and special measurements.

While performing display mode and/or special measurement calculations, MC2 uses numbers that have more decimals than are available on the display. In some cases these extra digits may cause rounding that differs from values that are shown on display. Notable differences between shown and manually calculated values usually mean that MC2's accuracy is not suitable for the given task.

Error %

Error Percentage display compares the measurements of the two windows based on entered measurement range values. The window the Error Percentage display was invoked from is considered the "output" of the instrument and the other window the "input".

The Error Percentage value is shown in the "output" window and the actual "output" signal is by default shown on the additional info row as seen in the rightmost picture.

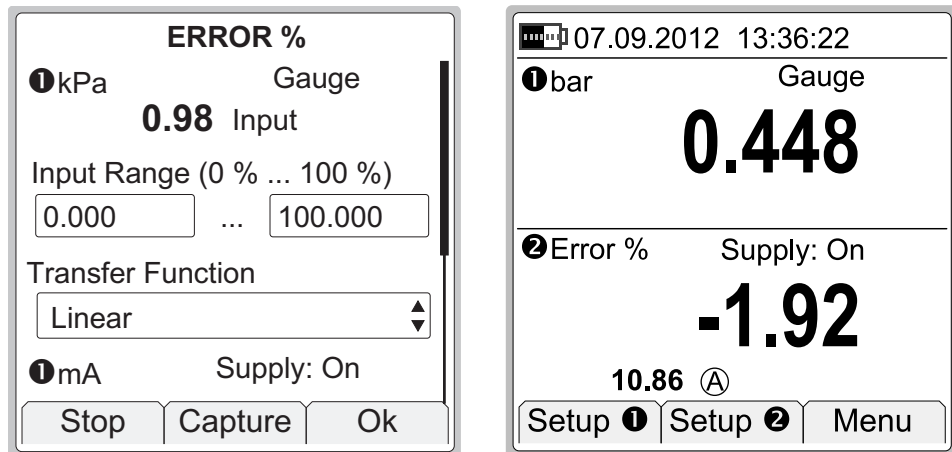

When Error Percentage display is active, the words "**Error %**" is displayed after the warning triangle.

To configure the error percentage display (and also the other types of error displays) you need to enter input and output range values to both windows.

In addition to the range you may also set the **Transfer Function** (Input/Output relationship). Default value is: **Linear**.

The display resolution may also be edited, if needed.

Notes.

If anything else was selected for display on the additional info row, the main measurement of the Error percentage window replaces the previous additional info data.

Also: if you select two other items to be displayed on the additional info row while an error display is active, the second item replaces the windows' main measurement data. **Beware of the problems that may result in not seeing the true measurement value.**

For help on making **Custom Transfer Functions**, see Part C, chapter **Custom Transfer Functions** on page 103.

Error in Input Units

Error In Input Units display compares the measurements of the two windows based on entered measurement range values. The window the Error display was invoked from is considered the "output" of the instrument and the other window the "input".

The Error In Input Units value is shown in the "output" window and the actual "output" signal is shown on the additional info row as seen in the rightmost picture.

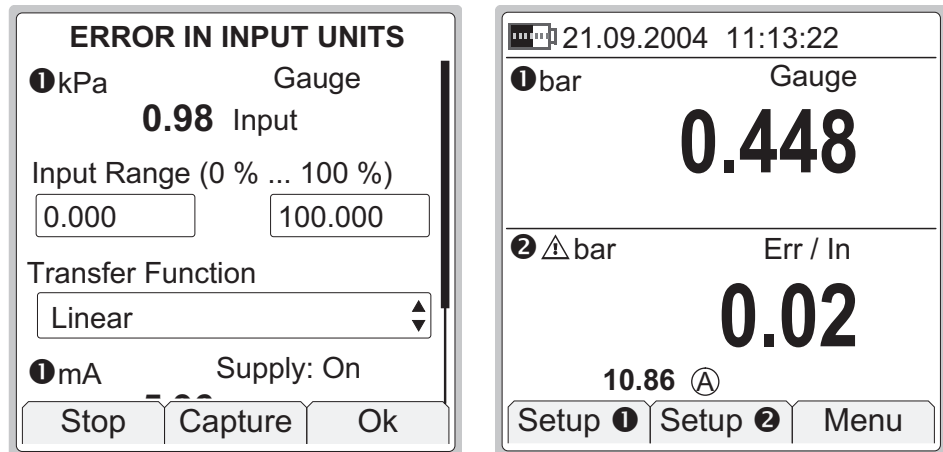

When Error In Input Units display is active, the warning triangle is shown together with the input unit and the text "**Err / In**" is shown above the Error value.

Error displayed in input units is in all other ways similar to error displayed in error percentage. The only difference is in how the calculated error is displayed.

For configuration details, refer to **Error %** on page 82.

Error in Output Units

Error In Output Units display compares the measurements of the two windows based on entered measurement range values. The window the Error display was invoked from is considered the "output" of the instrument and the other window the "input".

The Error In Output Units value is shown in the "output" window and the actual "output" signal is shown on the additional info row as seen in the rightmost picture.

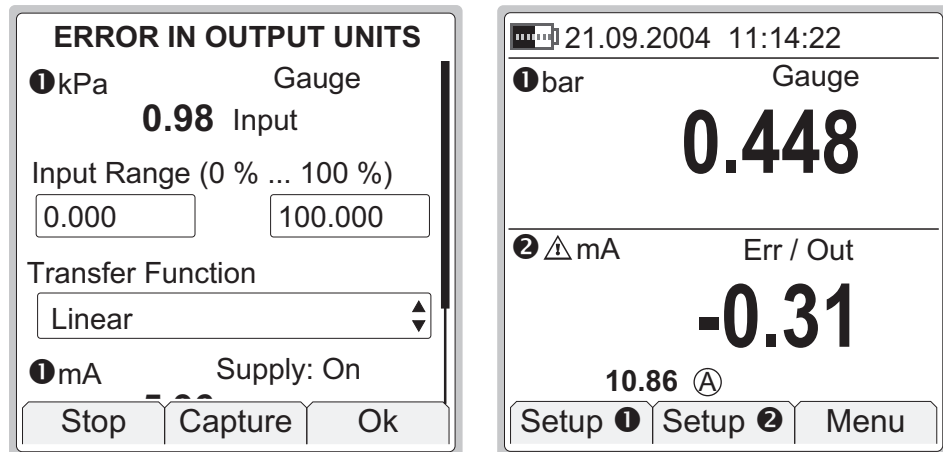

When Error In Output Units display is active, the warning triangle is shown together with the input unit and the text "**Err / Out**" is shown above the Error value.

Error displayed in input units is in all other ways similar to error displayed in error percentage. The only difference is in how the calculated error is displayed.

For configuration details, refer to **Error %** on page 82.

Percentage

Percentage display compares the measured/generated/simulated value against an entered range (0 % and 100 %).

When measuring, the measured value is replaced by the Percentage value. The measurement value in engineering units is shown on the additional info row as seen in the rightmost picture.

When generating/simulating, the Percentage is the editable value and the generated/simulated value in engineering units is shown on the additional info row.

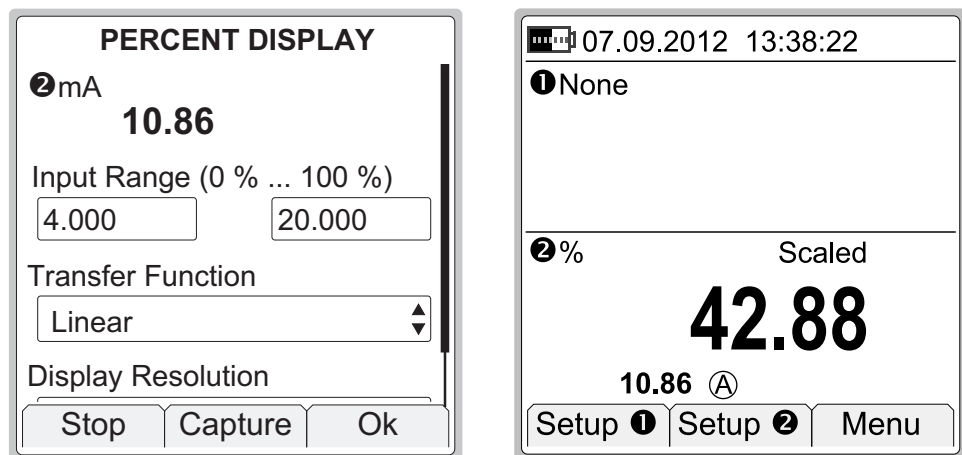

When Percentage display is active, the letter "%" is displayed after the warning triangle and the text "**Scaled**" is shown above the Percentage value.

To configure the percentage display, enter input range values for the selected quantity.

In addition to the range you may also set the **Transfer Function** (Input/Output relationship). The display resolution may also be edited, if needed.

Notes.

If anything else was selected for display on the additional info row, the main measurement of the window with percentage display replaces the previous additional info data.

Also: if you select two other items to be displayed on the additional info row while Percentage display is active, the second item replaces the windows' main measurement data. **Beware of the problems that may result in not seeing the true measurement value.**

For help on making **Custom Transfer Functions**, see Part C, chapter **Custom Transfer Functions** on page 103.

Scaling

In Scaling a measured/generated/simulated value may be converted to whatever "quantity" is needed, provided the conversion information is known.

When measuring, the measured value is replaced by the scaled value. The actual measurement value in engineering units is shown on the additional info row as seen in the rightmost picture.

When generating/simulating, the scaled value is the editable one and the generated/simulated value in engineering units is shown on the additional info row.

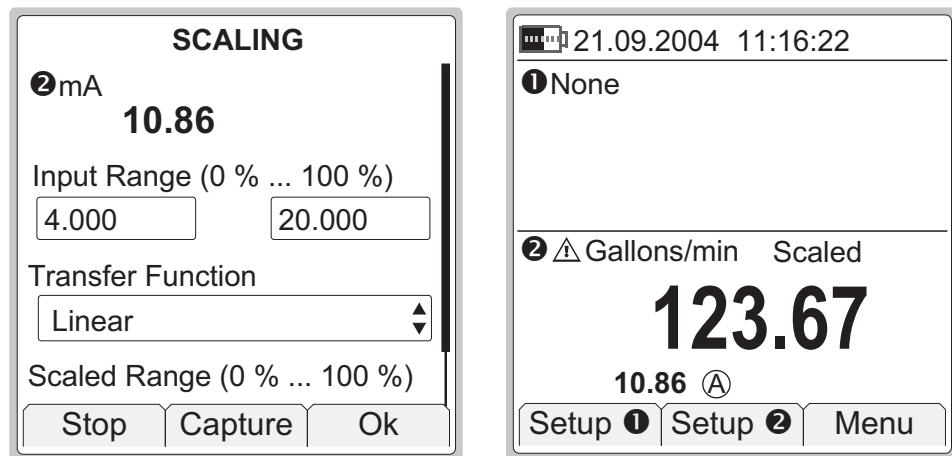

When Scaling display is active, the entered unit (or the text "**scaled unit**" if the unit was not entered) is displayed after the warning triangle and the text "**Scaled**" is shown above the Scaled value.

To configure Scaling, enter **Input Range** values for the selected quantity, set the **Transfer Function**, enter the **Scaled Range** and the **Unit** of the scaled range. The display resolution may also be edited, if needed.

Notes.

If anything else was selected for display on the additional info row, the main measurement of the window replaces the previous additional info data.

Also: if you select two other items to be displayed on the additional info row while Scaling display is active, the second item replaces the windows' main measurement data. **Beware of the problems that may result in not seeing the true measurement value.**

For help on making **Custom Transfer Functions**, see Part C, chapter **Custom Transfer Functions** on page 103.

Deviation

Deviation measurement compares a measured value against an entered reference value. The reference value is subtracted from the reading of the measured value. The difference replaces the measurement value. Both the reference value (indicated with a triangle) as well as the actual measurement value (indicated with a circled A) are shown on the additional info row as seen in the picture.

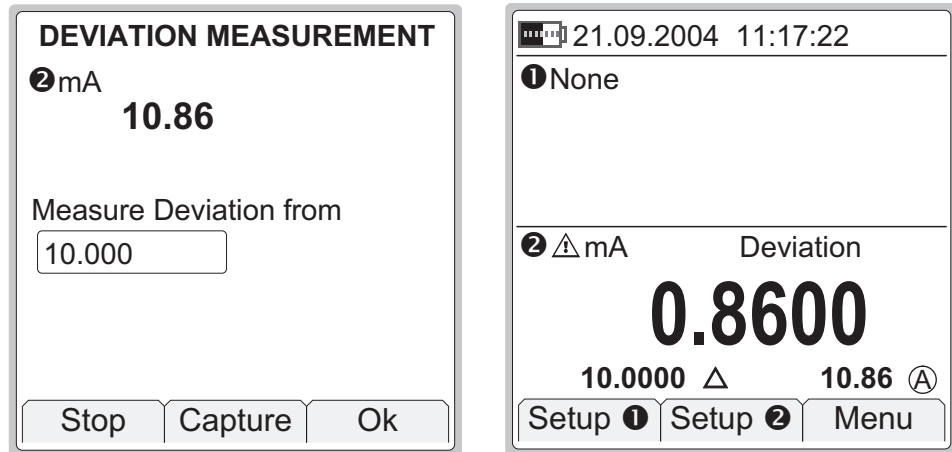

When Deviation measurement is active, text "**Deviation**" is shown above the Deviation value.

Hint.

Use the **F2/Capture** Function Key to add a measured "tare" as the reference value.

Notes.

If anything else was selected for display on the additional info row, the main measurement of the window replaces the previous additional info data.

Also: if you select two other items to be displayed on the additional info row while Deviation measurement is active, the second item replaces the windows' main measurement data. **Beware of the problems that may result in not seeing the true measurement value.**

Warning.

Keep in mind that when the displayed deviation reading is small compared to the actual reading, a significant part of the deviation value may be measurement error. See the specifications for measurement errors at the actual measurement level.

Redundant

In Redundant measurement two similar measurements (e.g. pressure measurement using both the internal and an external pressure module) are compared with each other. If the readings differ more than the entered limit value, MC2 gives an audible alarm.

The selected main measurement is shown normally. The secondary measurement value (indicated with a circled B) as well as the alarm limit (indicated with a triangle) are shown on the additional info row as seen in the rightmost picture.

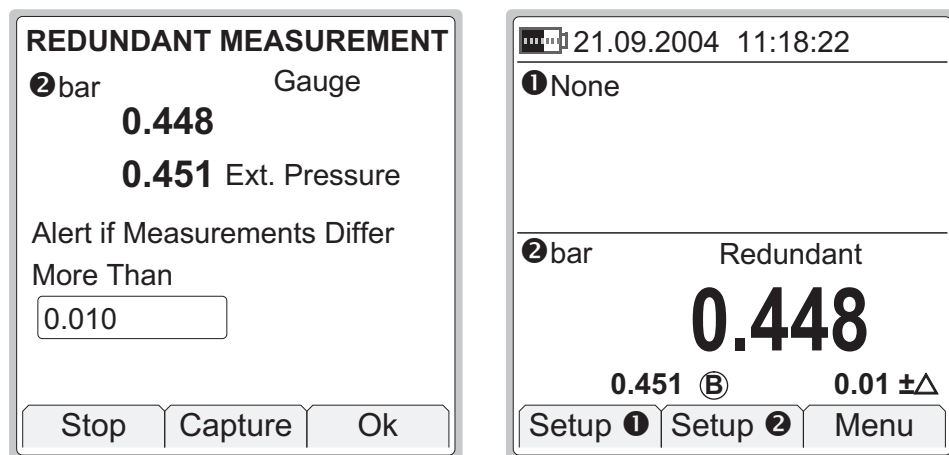

When Redundant measurement is active, text "**Redundant**" is shown above the main measurement value.

Notes.

If anything else was selected for display on the additional info row, the alarm limit and the secondary measurement replaces the previous additional info data.

Also: if you select other items to be displayed on the additional info row while Redundant measurement is active, the items replace the redundant measurement related data. **Beware of the problems that may result in not seeing the true measurement value.**

Redundant measurement can be activated only if two similar measurements are available, and neither of them is used for any other measurement.

Warnings.

When setting the allowed difference, take the accuracies of the measurements into account.

If the measuring spans of the selected ports are different, make sure you do not exceed the measurement range of either port.

Difference

In Difference measurement, two similar measurements (e.g. pressure measurement using both the internal and an external pressure module) are subtracted.

The Difference replaces the main measurement value. The main measurement (minuend, indicated with a circled A) as well as the secondary measurement value (subtrahend, indicated with a circled B) are shown on the additional info row as seen in the picture.

Difference measurement is active, text "**Difference**" is shown above the Difference value.

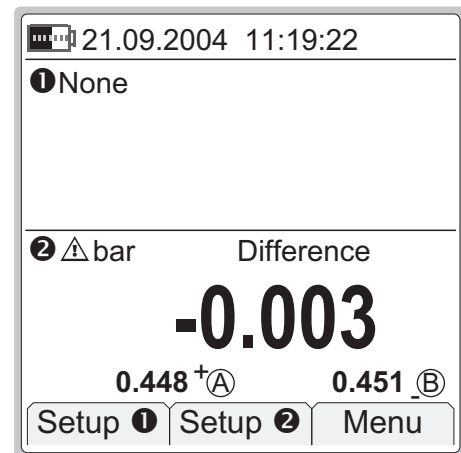

Notes.

If anything else was selected for display on the additional info row, the main measurement of the window replaces the previous additional info data.

Also: if you select other items to be displayed on the additional info row while Difference display is active, the items replace the Difference related data. **Beware of the problems that may result in not seeing the true measurement values.**

Difference measurement can be activated only if two similar measurements are available, and neither of them is used for any other measurement.

Warnings.

Keep in mind that when the displayed Difference reading is small compared to the actual reading, a significant part of the Difference value may be measurement error. See the specifications for measurement errors at the actual measurement level.

If the measuring spans of the selected ports are different, make sure you do not exceed the measurement range of either port.

Showing Data on the Additional Info Row

As presented in section A's User Interface chapter, both Basic Mode windows have an Additional Info row for showing additional data. Each window may have two values shown on their respective Additional Info rows. The only exception is the bar graph option. It reserves the whole Additional Info row alone.

All Additional Info Row settings are in: **F1/Setup ①** or **F2/Setup ②** (depending on which window you want to change the display mode for), **F2/Tools**. Select **Show Additional Info** from the opened menu.

The data available to be shown on the Additional Info row can be divided into following groups:

- **Data that is Always Available.**
Can be selected to be shown at any time.
- **Display Mode and Special Measurement Related Data.**
Data that is available to be shown depending on Display Mode and Special Measurement settings.
- **Function Dependent Data.**
Data that is available for certain Functions, e.g. barometric pressure when it is needed.

The following chapters present the data available to be shown on the Additional Info row. Any limitations as to when the data is available are mentioned where applicable. Below each heading is the icon or unit displayed on the Additional Info row when that particular Additional info is shown.

Maximum value

↕ Displays the found maximum value after a measurement was started or it was reset.

Minimum value

↕ Displays the found minimum value after a measurement was started or it was reset.

Rate of Change Value (unit 1/min)

↗ Displays the calculated rate of change value (units/min) found after a measurement was started or the calculation was reset.

Maximum - Minimum

± Calculates the difference between the maximum and minimum measurement value found after a measurement was started or it was reset.

Cumulative Average

\bar{x} Calculates the cumulative average of measurements after a measurement was started or it was reset.

Cumulative average means that, after the calculation is started, every new measurement is included in the average calculation. Thus the amount of measurements included in the cumulative average increases all the time and the average value's change rate typically gets smaller with time.

Internal Temperature

°C,
°F or
K When an internal or an external pressure module is used in a window, the internal temperature of the pressure module can be selected to be shown.

Normal Reading

Ⓐ Normal Reading refers to the window's **main measurement**. It is available when the following Special Measurements reserve window's main value: All **Error Display Modes** as well as **Percentage, Scaling and Deviation** measurement.

Deviation Reference

△ Available when deviation measurement is active. This is the entered reference value MC2 uses to calculate the measurement's deviation from.

Redundant Measurement (Secondary Measurement)

Ⓑ The secondary measurement used during redundant measurement.

Redundant Reference

±△ The alert limit that is entered when redundant measurement was started. Available only when redundant measurement is active.

Difference A

+Ⓐ Displays the main measurement during a difference measurement.

Difference B

ⓑ Displays the secondary measurement during a difference measurement.

Barometric Pressure

P_B Displays the barometric pressure value that is used for measurement's pressure type conversion. This value comes usually from built-in barometer, but some high-pressure modules may allow using manually entered barometer value.

Feedback Measurement

V, mV, μV, mA, μA, °C, °F or K Available for the following generation/simulation Functions:
(same unit as main value)

- **Voltage Generation**
- **Low-Voltage Generation**
- **T/C Sensor Simulation**
- **Current Source or Sink**

When MC2 generates voltages or current, it uses its own measurement Functions to control the generated value. This feedback measurement may be displayed on the Additional Info row.

Thermovoltage, RJ = 0°C

mV₀ Displays the thermovoltage for reference junction temperature 0°C. Suitable for referring to thermovoltage table values. Available for **T/C Sensor Measurement** and **T/C Sensor Simulation** Functions with temperature unit selected.

Thermovoltage

mV Displays the actual measured thermovoltage for reference junction temperature. Available for **T/C Sensor Measurement** and **T/C Sensor Simulation** Functions.

RJ Temperature

°C, °F or K Displays the temperature of the reference junction in use. Available for **T/C Sensor Measurement** and **T/C Sensor Simulation** Functions.

Sensor Resistance

Ω Displays the real resistance MC2 is measuring or simulating for an **RTD sensor** Function.

Pulses Done

Displays the pulses currently done during **Pulse Generation**.

Pulses Left

Displays the pulses currently left to be done during **Pulse Generation**.

Bar Graph

A Bar Graph is always available in the list of Additional Info row data, but the type of Bar Graph depends on the Display Mode and Special Measurement settings. The bar graph is always related to the main value (big numbers) and its units, so configure the Bar Graph's range accordingly.



If any of the Error Display Modes is active, the Bar Graph displays a graphical presentation of the error value. The middle of the graph represent zero error and the symmetrical "width" of the graph is user configurable

Resetting and Clearing Additional Info Row / Calculations

Active minimum, maximum, rate of change, maximum – minimum and cumulative average calculations may be reset using the additional option found in the window's Tools menu: **Reset Min / Max / Rate**.

Changing the Function for a window sets all Additional Info data to default values (usually nothing).

Activating a Display Mode or a Special Measurement often replaces them with data related to the activated Display Mode or Special Measurement. Any previously activated minimum, maximum or rate of change calculations are still working, but are no longer shown (until selected to be shown again).

(Empty)

Advanced Operation and Configurations

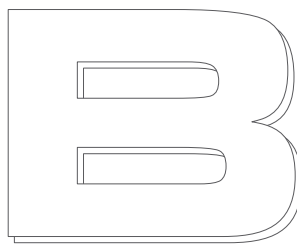
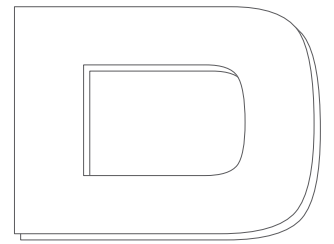

Things discussed in Part C:

- Advanced tools found in the Utilities Menu.
- Help on how to create customized test point sets and transfer functions.
- Related information: Useful during pressure measurement, thermocouple measurement/simulation and resistance/RTD measurement/simulation.

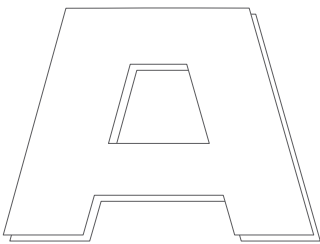

Utilities Menu

This chapter and its subchapters present items available in the utilities menu that opens from Basic Mode by pressing **F3/Menu**.

About This Calibrator

Opens a window presenting basic information of MC2.

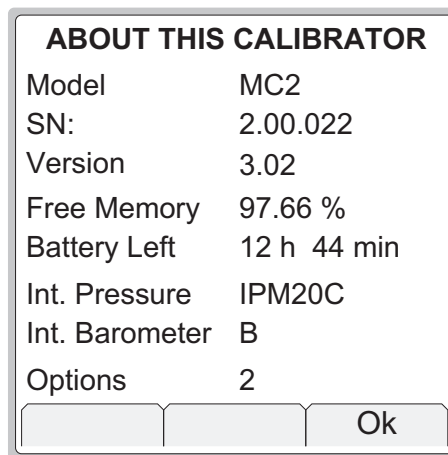

Battery Left is an estimate of remaining usage time.

Pressure modules, if any, are listed below the usage time estimate.

User Setups for ❶ & ❷

MC2 supports saving user settings for window ❶ and window ❷. The available free memory defines how many user settings may be saved.

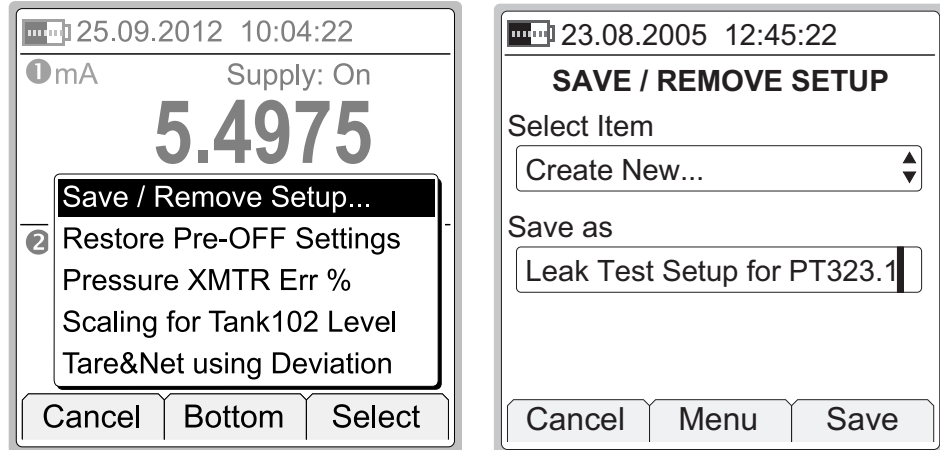

In the leftmost picture above, three User Setups are already saved. Selecting Save / Remove Setup option opens the **SAVE / REMOVE SETUP** window allowing you to save the current settings for window ❶ and window ❷ (see rightmost picture).

About the second item on the list shown in the leftmost picture above: **Restore Pre-OFF Settings**:

MC2's startup is made as straight forward as possible. It does not automatically restore its more advanced functions (display mode, special measurements etc.) used when MC2 was shut off. By selecting the **Restore Pre-OFF Settings** option, it is possible to restore MC2's advanced functions used before it was last shut off.

Date/Time

Allows you to select the displayed date and time formats according to your needs. This window is also used to set date and time. Use the **day**, **month**, **year** and **hour (24)**, **min**, **sec** fields to set the date/time.

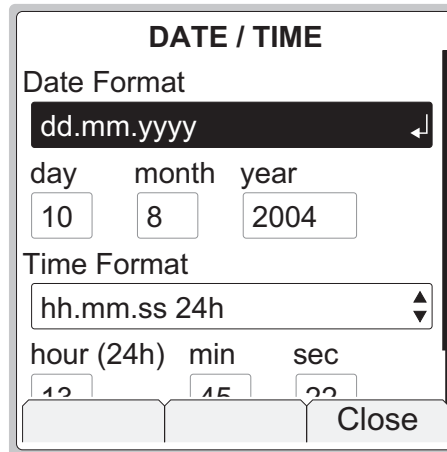

The screenshot shows a dialog box titled "DATE / TIME". It contains two main sections: "Date Format" and "Time Format".

Date Format: A dropdown menu is set to "dd.mm.yyyy". Below it are three input fields labeled "day", "month", and "year" with values "10", "8", and "2004" respectively.

Time Format: A dropdown menu is set to "hh.mm.ss 24h". Below it are three input fields labeled "hour (24h)", "min", and "sec" with values "12", "15", and "22" respectively.

A "Close" button is located at the bottom right of the dialog box.

Notes.

The time must always be given in the **24 hour** format no matter what the configured time format is.

Date and time will be immediately updated when you change the value of any of the time related fields.

General Settings

This window allows you to edit the following settings:

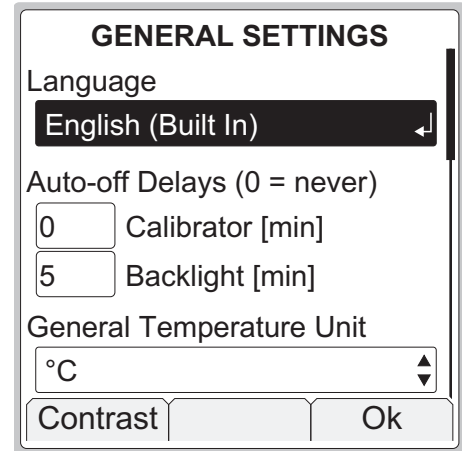

FIELD	NOTES
Language	Contains a list of User Interface languages.
Auto-off Delays: Calibrator [min] Back light [min]	Wait time before auto power off is executed and before the display light is automatically switched off. See also notes after this table. Value 0 (zero) means the Auto-off delay is disabled.
General Temperature Unit	Select either °C (Centigrade) or °F (Fahrenheit) as the temperature unit.
Temperature Scale	Contains a list of standard temperature scales.
Key Click Volume, Alarm Volume, Attention Volume, Outside Span Volume and, Error Volume	Available options (apply to all volume settings): Off, Low, Medium and High.
Net Frequency	Options: 50 Hz and 60 Hz. Note that wrong net frequency setting affects the accuracy of MC2.
Owner	A text field for entering owner's name etc. This data is shown in the Welcome Screen.

Notes.

All changes in general settings become valid immediately except when changing the language. To activate the new language, shut off and restart MC2.

Disable auto-off delay during long-time tasks (e.g. leak/stability test). Otherwise the auto-off functionality interrupts the task.

When calibrator's **Auto-off delay** is in use (value other than zero), a warning dialog pops up 30 seconds before the auto power off executes. In the dialog the Function Keys have the following options:

- **F1/Cancel**
Cancels the auto power off feature *for the moment*, but it stays active even during this session.
- **F2/Stop**
Disables the auto power off feature *for this session*. It will reactivate when the calibrator is switched on the next time.
- **F3/Ok**
Immediately shuts down the calibrator.

Calibrator Adjustment

Opens a window to start the recalibration and adjustment of MC2.

See Appendix 2 for instructions on how to recalibrate MC2.

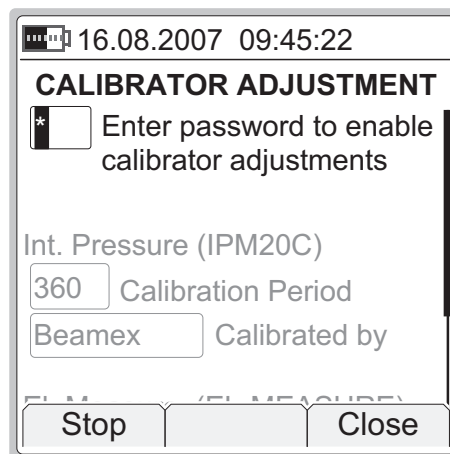

Custom Test Point Sets

MC2 has a comprehensive set of pre-entered test point sets (steps). If however they are not suited for your needs, you can create your own test points as presented here.

Start the custom test point definition from one of the following utilities found in generation/simulation functions' **Tools** menu:

- **Stepping** presented on page 73 and
- **Manual Stepping** presented on page 78.

One of the utilities' configuration fields is **Step Definition** combo. The last option in the combo is **Create New**. It opens the custom test point tool. If a custom set already exists, selecting it in the **Step Definition** combo also opens the custom test point tool.

Give a name to the Custom test point set. The **Scaled Range** initially has the same range as defined for the Stepping or Manual Stepping from where the custom test step definition was invoked. You may edit the **Scaled Range** according to your own needs during step definition, e.g. scale the steps to percentage values.

Enter the point values. Press down arrow (▼) to add a point below the last point.

EDIT TESTPOINT SET		
Set Name		
Just Test Set		
Scaled Range (0 % ... 100 %)		
4.0000	...	20.0000
1.	4.0000	0 %
2.	6.0000	13 %
3.	7.5000	22 %
Close	Menu	Save

The **F2/Menu** Function Key opens a menu for editing the test point rows or the whole set. Options:

- **Insert Row**
- **Delete Row**
- **Delete All Rows**
- **Copy Set**
- **Delete Set**

The **Insert Row** option adds a point **above** the current point.

The **F3/Ok** Function Key saves the custom test point set and adds it to the **Define Steps** combo list. It is located after all pre-entered test point sets, before the **Create New** option.

To separate custom point sets from pre entered ones, custom point sets are prefixed "User:" and the row ends with a chevron pointing right ")". This indicates that the point set may be edited.

Hints!

The point values need not be in ascending order or even inside the range limits.

To force MC2 to stay in one point for a longer time, enter the same point value to several successive points.

Notes.

The step values are saved as floating point number percentage values so the steps may be used for any Function and range. The percentage values are proportioned to the current **Stepping / Manual Stepping** range.

The percentage values shown to the right of the test points are whole number near values of the entered values. They are for information only.

The available free memory defines how many custom test points may be saved. If there is not enough memory left to save a custom test point set, MC2 displays an error message suggesting that you first free some memory and then retry adding a custom test point set.

Custom Transfer Functions

MC2 has a pre-entered set of standard transfer functions. If however they do not suit your needs, you can create your own transfer functions as presented here.

The custom transfer function definition can be started from the following **Display Modes** (found in the **Tools** menu of measurement functions):

- **Error %** presented on page 82,
- **Error in Input Units** presented on page 83 and
- **Error in Output Units** presented on page 84.

And from the following **Display Modes** (always available in the **Tools** menu):

- **Percentage** presented on page 85 and
- **Scaling** presented on page 86.

And also from the **Tools** menu of the following **generation/simulation** Function utilities:

- **Stepping** presented on page 73 and
- **Manual Stepping** presented on page 78.

One of the combos in all of the above mentioned utilities is called **Transfer Function**. The last option in the combo is **Create New**. It opens the custom transfer function tool. If a custom transfer function already exists, selecting it in the **Transfer Function** combo also opens the custom transfer function tool.

Give a name to the custom transfer function.

The **Input Range** and **Output Range** fields are scaled ranges for the custom transfer function. Default values are for percentage scaling.

Enter Input/Output pair values in ascending order. Press down arrow (▼) to add more Input/Output pairs below the last Input/Output pair.

The **F2/Menu** Function Key opens a menu for editing the Input/Output pairs or the whole set. Options:

- **Insert Row**
- **Delete Row**
- **Delete All Rows**
- **Copy Set**
- **Delete Set**

The **Insert Row** option adds an Input/Output pair **above** the current Input/Output pair. The new row has default values based on the Input/Output pairs above and below it (calculated using linear approximation).

The **F3/Ok** Function Key saves the custom transfer function and adds it to the **Transfer Function** combo list. An inverted copy of the custom transfer function is also added to the **Transfer Function** combo list. The inverted transfer function has a "x⁻¹" symbol before its name. The custom transfer function and its inverted copy are located after all pre-entered transfer functions but before the **Create New** option.

To separate custom transfer functions from pre entered ones, custom transfer functions are prefixed "User:" and the row ends with a chevron pointing right "⟩". This indicates that the point set may be edited.

Hint!

The maximum Input/Output pair values may be outside the ranges' maximum values.

Notes.

The Input/Output pairs are saved as floating point number percentage values so the transfer function may be used for any function and range. The percentage values are proportioned to the current range.

The available free memory defines how many custom transfer functions and Input/Output pairs may be saved. If there is not enough memory left to save a custom transfer function, MC2 displays an error message suggesting that you first free some memory and then retry adding a custom transfer function.

MC2 approximates the values between entered input/output pairs by calculating a curve between a pair of points that connects smoothly to the adjoining curve. The entered Input/Output pairs need to be points of a strictly increasing function.

Custom Pressure Units

MC2 has a comprehensive set of pre-entered pressure units. If however they are not suited for your needs, you can create your own custom pressure units.

To define custom pressure units, configure one of the Basic State's windows (select **F1/Setup ①** or **F2/Setup ②**) for pressure measurement. While configuring, open the Unit combo and select one of the "User" units. They can be found at the bottom of the list of pressure units (as long as they are not in use and not selected to the "favorites" list).

When selecting a user configurable unit, a window opens for configuring the unit.

Saved custom pressure units can be seen in the pressure unit list. To separate them from pre entered units, they are prefixed "User:" and the row with a custom pressure unit ends with a chevron pointing right "⟩". This indicates that the unit may be edited.

USER UNIT SETTINGS

User Unit Name

Factor

Reference Unit

Cancel Ok

Notes.

Make sure you do not run any tasks found in the **Tools** menu (e.g Scaling) while editing a user defined unit. All **Tools** menu tasks utilize the user defined unit as it was when starting the task.

To remove a Custom Pressure Unit, open it in **User Unit Settings** window and clear **User Unit Name** field. Then press **F3/Ok**.

See also Part B, chapter **Scaling**.

Related Information

Most of the measurements, generations and simulations presented in this manual are straight forward: Just make the required window settings and connect the instrument under test to the active terminals and that's it!

Some cases require additional settings and things to check before you can be certain that the measurement, generation or simulation works as expected. A typical example of this is temperature measurement using a thermocouple. It is not enough to select the correct Function in MC2. The Sensor type and the Reference Junction Mode has to be set accordingly, too. Wrong settings give erroneous results.

Whenever this additional information may be of use in a measurement, generation or simulation, text describing the Function refers to one of the following chapters. An experienced may skip this supplemental text, but for a beginner we highly recommend it.

The subjects described here are:

- **Things to Consider when Measuring Pressure** on page 108,
- **Pressure Type** on page 108,
- **Pressure Modules and their Naming Conventions** on page 109,
- **Square Rooting** on page 110,
- **Thermocouple Measurement/Simulation, Connections and Troubleshooting** on page 111,
- **Resistance and RTD Measurement, Connections** on page 116,
- **Current Measurement Parallel to a Test Diode, Connections** on page 118 and
- **Parallel Functions in MC2** on page 119.

Things to Consider when Measuring Pressure

General

MC2 can measure pressure with its internal pressure module or with external pressure modules. If a barometric module is present, the measurement results of other modules can be shown either as absolute pressure or as gauge pressure.

Pressure Type

Every pressure measurement is in fact a pressure difference measurement: a given pressure value is compared against a reference pressure. In certain cases the reference pressure has a special meaning (like the atmospheric pressure) and the pressure measurements with reference to against these points are given a special name:

- **Absolute pressure measurement** uses vacuum as the reference pressure.
- **Barometric pressure** (or **atmospheric pressure**) is the absolute pressure of the surrounding atmosphere. It is specially titled because of its importance.
- **Gauge pressure measurement** uses the atmospheric pressure as the reference. Gauge pressure may be zero, negative or positive. Most of MC2's pressure modules actually measure gauge pressure although they may be used for measuring other pressure types too.
- **Differential pressure measurement** requires a special differential pressure module that has an input available for both the reference pressure and the given pressure.

To be able to measure absolute pressure with MC2's gauge pressure modules, you need a barometric pressure module. Certain high pressure modules may approximate absolute pressure measurement by adding an entered barometric pressure to the measured gauge pressure.

MC2 may use two standard pressure modules to measure (pseudo) differential pressure: One module measures the reference pressure and another the given pressure. The pressure difference is calculated by subtracting the reference pressure from the given pressure. More of this in Part B, chapter **Display Mode and Special Measurements**.

Always ensure that the pressure type setting of your pressure measurement is what you intended it to be. The pressure type setting is crucial for getting meaningful pressure measurement results.

Pressure Modules and their Naming Conventions

MC2's software refer to pressure modules as follows:

IPM200mC

which means that there is an **internal pressure module** installed with a **-200 to +200 mbar** (-3 to +3 psi) pressure range.

The names of MC2's internal pressure modules start with the letters **IPM**. The names also include numbers and possible additional letters as follows:

- The number defines the max. nominal pressure in the SI pressure unit **bar**.
- If the number is followed by a small "m", the given max. nominal pressure is given in **mbar**.
- The additional letter **C** means the pressure module is a compound module with an ability to also measure negative gauge pressures.

Examples:

Name	Measurement range	in psi
IPM200mC	±200 mbar	± 3
IPM20C	-1 ... 20 bar	-14.5 ... 300
IPM160	0 ... 160 bar	0 ... 2400

Notes.

Compound modules with a max. nominal pressure above 1 bar (e.g. IPM20C) are able to measure negative pressures down to -1 bar. Compound modules with a max. nominal pressure below 1 bar (e.g. IPM200mC) are only able to measure as deep negative pressures as positive pressures.

External pressure modules have a naming convention that is similar to internal ones.

Square Rooting

Pressure transmitters or converters used for flow measurement often have square rooting character. Here are a couple of examples on how you can configure MC2 to take into account the instrument's square rooting character:

1. Set the **Display Mode** of window that measures the instrument's output signal to **Error Percentage** and make sure the **Transfer Function** field is set to Square Rooting (\sqrt{x}).
2. Use **Scaling** to convert the instrument's output signal to a suitable format and again, make sure the **Transfer Function** field is set to Square Rooting (\sqrt{x}).

Display Modes as well as scaling is discussed in chapter **Tools Menu** in part B of this User Guide.

Thermocouple Measurement/Simulation, Connections and Troubleshooting

To accurately measure the thermovoltage caused by the temperature to be measured, the second thermovoltage caused by the Reference Junction needs to be compensated. This is done using one of the Reference Junction compensation methods described in the subsequent chapters.

The Reference Junction compensation method has to be chosen both when measuring and simulating thermocouples.

Internal Reference Junction

MC2's Internal Reference Junction makes thermocouple measurement/simulation easy. No external connections are required, just connect the thermocouple or a thermovoltage receiver directly to MC2's "T/C" terminals. To select this compensation method, set the window's Function to field "**T/C Sensor Measurement**" or "**T/C Sensor Simulation**", make sure the **Unit** is a temperature unit and set the **RJ Mode** field to "**Internal**".

Connection when measuring/simulating thermocouples using Internal Reference Junction Mode:

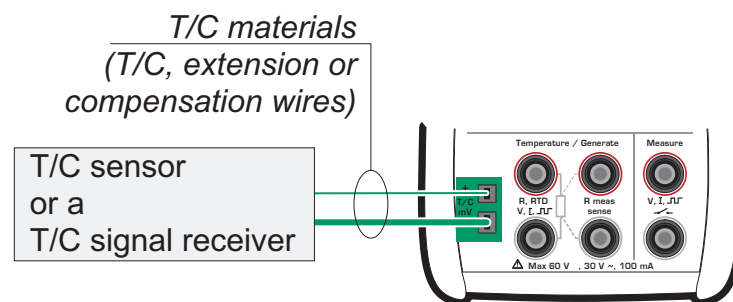

Refer to the Technical Data in Appendix 1 for specifications concerning the Internal Reference Junction.

See also...

External Reference Junction on page 112

External Reference Junction

When using an external Reference Junction, MC2 measures or simulates the thermovoltage using the "T/C" terminals. The following external Reference Junction compensation methods are available:

External RTD:

To be used when:

- The Reference Junction temperature is measured using an RTD sensor connected to MC2's RTD terminals.

Connection when measuring/simulating thermocouples using Reference Junction compensation method "External RTD":

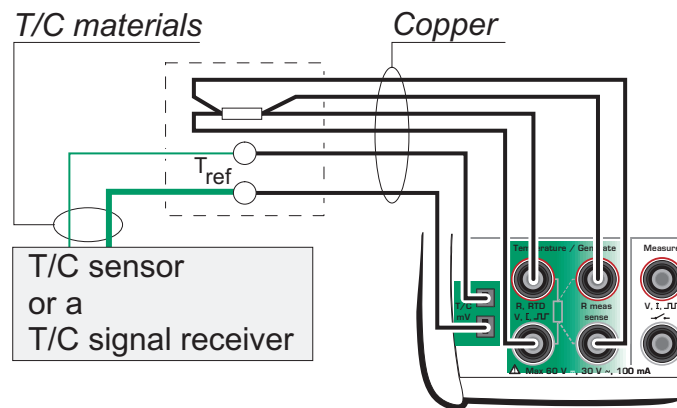

Warning!

If you connect an RTD sensor to the RTD connectors, there is no galvanic isolation between the thermocouple and the RTD sensor.

None (0 °C):

To be used when:

- The Reference Junction temperature is **fixed** to 0°C (using, e.g. ice) and MC2 is not used for measuring the Reference Junction temperature.
- The Reference Junction temperature is **controlled** with 0 °C set point.
- A compensation box is used and the Reference Junction temperature setting is 0 °C.
- There is no Reference Junction compensation in the measuring/simulation circuit but 0 °C is a good enough approximation.

Manually Entered:

Usable when:

- The Reference Junction temperature is **fixed** to a temperature that differs from 0 °C.
- The Reference Junction temperature is **controlled** and the controller's set point is not 0 °C. Note: this method is of use only if the accuracy of the controller is better than MC2's own Reference Junction.
- A compensation box is used and the Reference Junction temperature setting is other than 0 °C.
- There is no Reference Junction compensation in the measuring/simulation circuit, but you want to manually enter another Reference Junction temperature than 0 °C.

Connection when measuring/simulating thermovoltages using a temperature controller and either of the following Reference Junction compensation methods:

"Manually Entered" or "None (0 °C)":

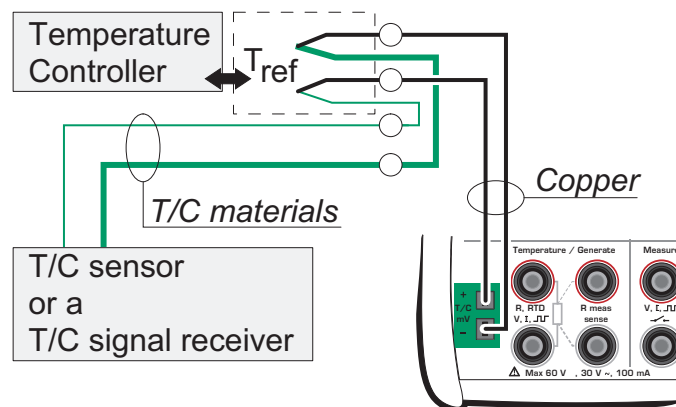

Connection when measuring/simulating thermovoltages using a fixed temperature and either of the following Reference Junction compensation methods:

"Manually Entered" or "None (0 °C)":

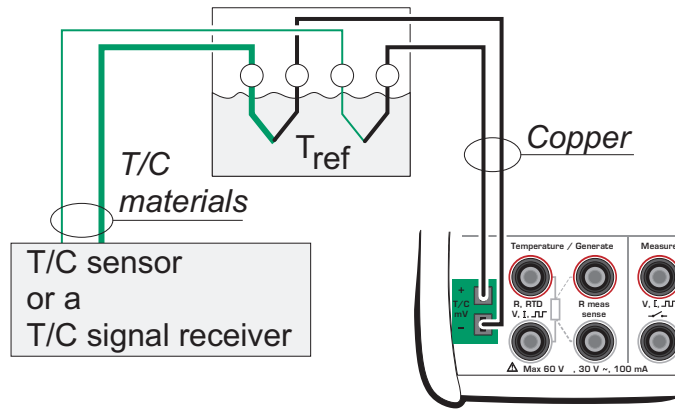

Connection when measuring/simulating thermovoltages using a compensation box and either of the following Reference Junction compensation methods:

"Manually Entered" or "None (0 °C)":

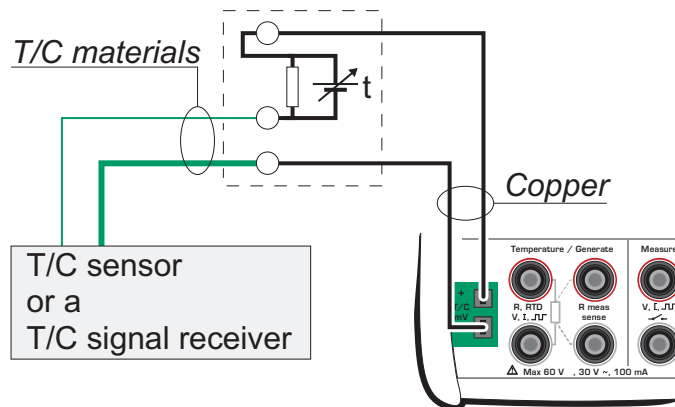

See also...

Internal Reference Junction on page 111

Error situations

The easiest way to avoid errors in thermocouple measurement and simulation is to check carefully the used wiring and the Reference Junction mode. The following table describes the typical error situations and possible causes/corrections when working with thermocouples:

PROBLEM	CAUSE
MC2 (or the instrument under test when simulating thermovoltages) measures the temperature/millivolt signal, but the displayed temperature reading is all wrong. (The error may vary from 0 to about ± 50 °C depending on the type of the error)	<ul style="list-style-type: none"> • The thermocouple type selected in MC2 does not correspond with the used thermocouple. • The selected Reference Junction mode is not in accordance with the used wiring. • Extension or compensation cable type or connections are incorrect. • The polarity of the cables are incorrect.
MC2 (or the instrument under test) displays random readings during thermocouple measurement.	<ul style="list-style-type: none"> • Incorrect connections. • The wiring is broken. • Interference from a mobile phone or a radio transmitter affects the measurement.
MC2 displays unstable readings during thermocouple simulation.	<ul style="list-style-type: none"> • The instrument to be calibrated uses voltage pulses to detect an open sensor. When MC2 detects these pulses, it tries to compensate for them, which causes the unstable output. Prevent these pulses for the time of calibration. Refer to the service manual of the instrument to be calibrated on how to prevent these open sensor detection pulses.

Resistance and RTD Measurement, Connections

The two main problems in resistance and RTD measurement are the effects of wiring resistances and thermovoltages in the resistance measurement circuit. If possible, use 4-wire connection to eliminate the effect of wiring resistance. The special resistance measurement sequence of MC2 eliminates the thermovoltages of the resistance measurement circuit.

MC2 continuously checks the connection type during resistance and RTD measurement. The found connection type is displayed on the resistance or RTD measurement window.

4-wire System



When 4-wire system is used, MC2 displays the symbol shown on the left.

MC2 sources current through the resistor from the two left side terminals. MC2 measures the voltage drop across the resistor from the two right side terminals. The 4-wire method gives the resistance between the terminals of the resistor, it is insensitive to the resistance of the connection wires.

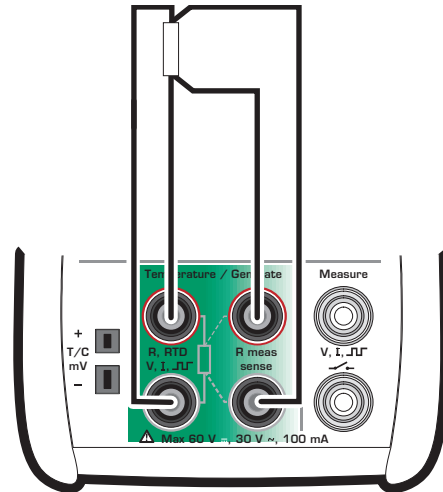

3-wire System



When 3-wire system is used, MC2 displays the symbol shown on the left.

MC2 sources current through the resistor from the two left side terminals. MC2 measures the voltage drop across the entire current loop and across the low side connection wire. If both left side connection wires are identical, MC2 can compensate for the resistance of the connection wires.

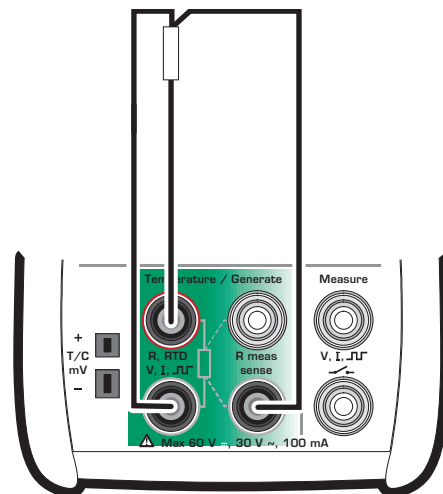

Using a Compensation Loop



When the compensation loop wiring system is used, MC2 displays the symbol shown on the left.

MC2 sources current through the resistor and the compensation loop from the two left side terminals. MC2 measures the voltage drop across the entire current loop and across the compensation loop.

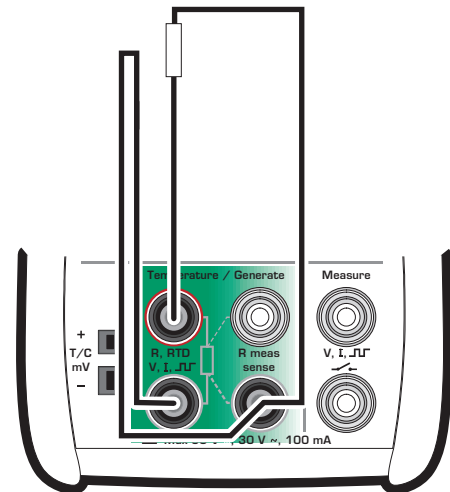

If the compensation loop and the connection wires of the resistor are identical, MC2 can compensate for the resistance of the connection wires.

2-wire System



When 2-wire system is used, MC2 displays the symbol shown on the left.

Calibrator sources current through the resistor and measures the voltage drop across the same terminals.

The result is acceptable, if the resistance of the connection wires is significantly smaller than actual measured resistance.

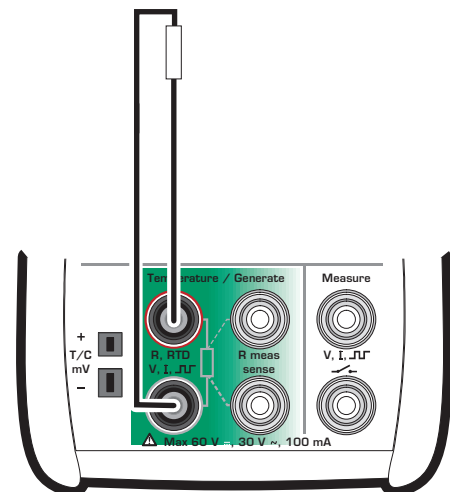

Hint!

To minimize the effect of connection wires in 2-wire system measurement, use deviation measurement presented on [page 87](#) as follows:

Measure the resistance of only the connection wires. Set the measured value as the **Measure Deviation from** value. Then the resistance of the connection wires is subtracted from the total resistance and the displayed deviation value is closer to the resistance meant to be measured.

Current Measurement Parallel to a Test Diode, Connections

The impedance of MC2's milliampere input is low enough to enable current measurement parallel to a test diode in a 20 mA circuit.

Plus Side Test Diode Connections:

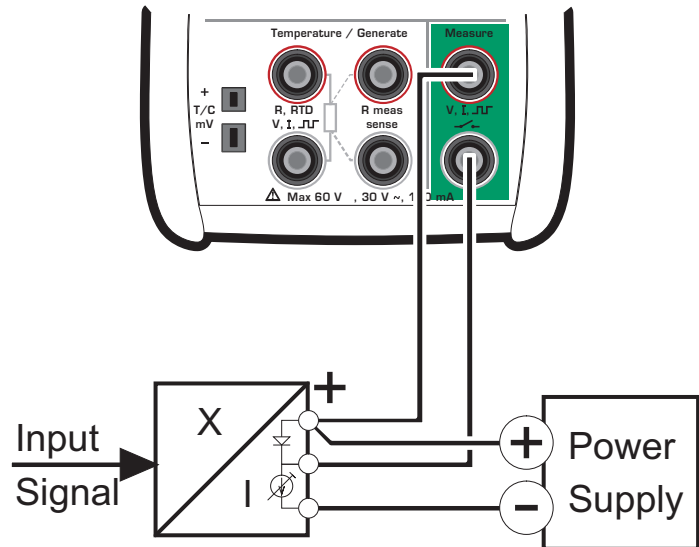

Minus Side Test Diode Connections:

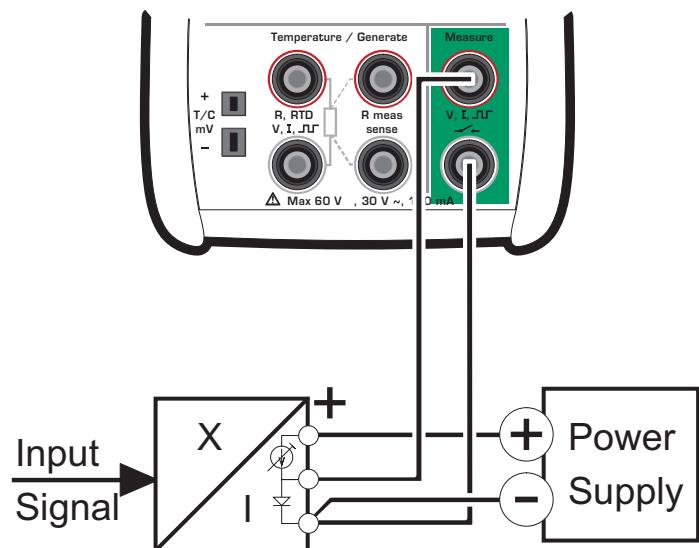

MC2 parallels the test diode of the transmitter and measures the externally supplied output current of the transmitter.

Notes.

In higher temperatures: The leakage of the diode in the instrument may affect the accuracy.

Parallel Functions in MC2

This chapter explains what kind of simultaneous duties MC2 can do.

All of the following tasks may run independently, but the window settings decide what is shown:

- Each internal or external **pressure measurement** runs independently.
- One electrical measurement in the **Measure** terminals.
- One electrical measurement and one electrical generation/simulation in the **Temperature / Generate** terminals.

Additionally, all of the connectors on the left side of MC2 may have an independent task.

Notes.

The Barometric module can always be used for pressure type conversion, even if it is already active in any window.

See **Part D, Calibration**, chapter **Supported Input/Output Signal Combinations** for additional info on which Functions may simultaneously be active during instrument calibration .

(Empty)

Calibration

D**C****B****A**

Things discussed in Part D:

- General presentation of what calibration is and the phases of a typical calibration procedure.
- A description of a calibration procedure using MC2.
- Some application examples on how to perform the calibration of certain instruments.

General

MC2 is a stand-alone calibrator. All calibration results are manually entered either to a paper document or to a calibration software capable of making printed calibration certificates.

Phases of Instrument Calibration

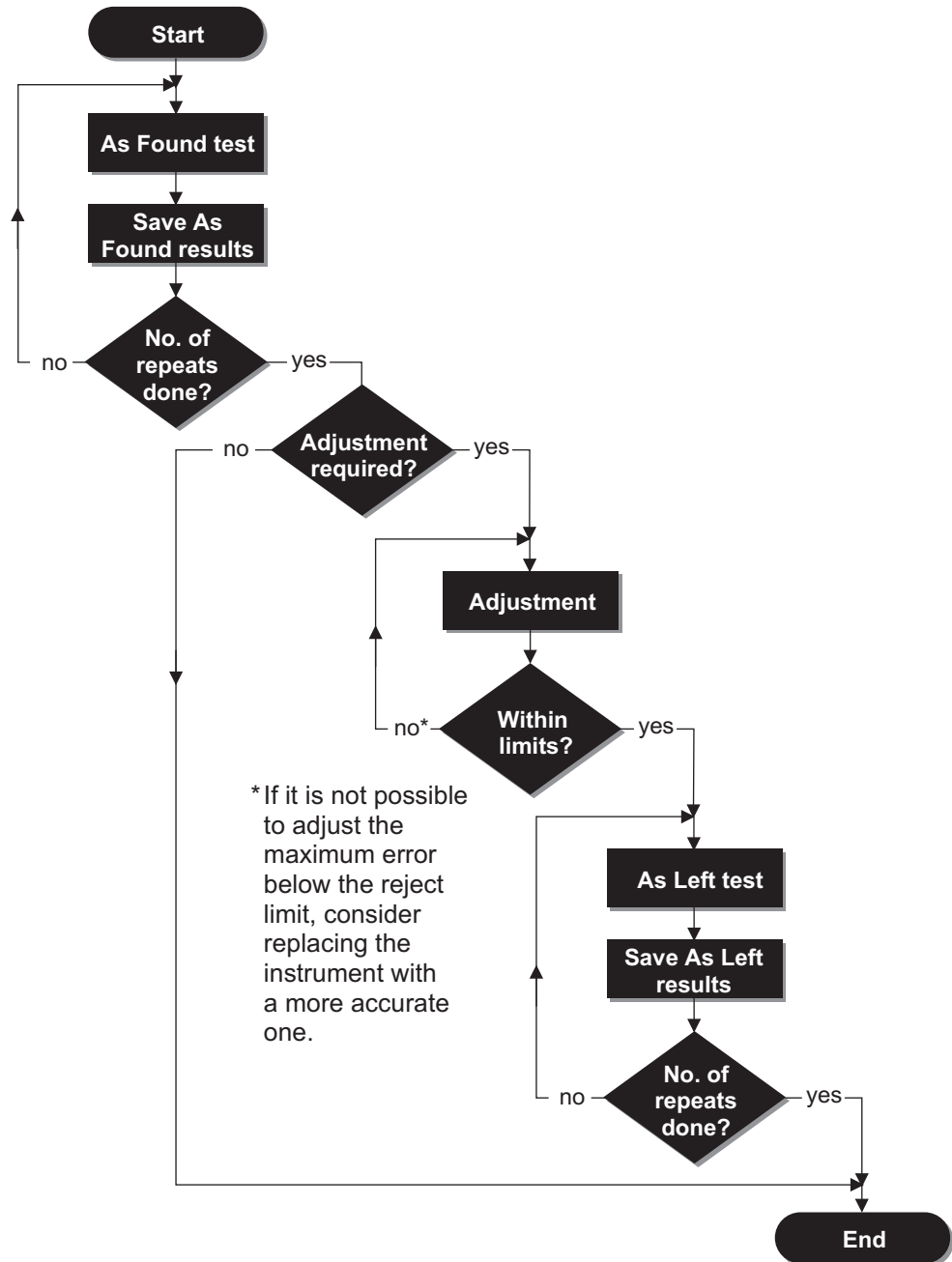

The picture gives a general view of the phases in a typical calibration procedure.

As Found Calibration

The As Found calibration documents the state of the instrument before carrying out any adjustments. The calibration specifies the amount of drift in the instrument during the calibration period.

Below is an example of an error graph. It is used for evaluating the instrument.

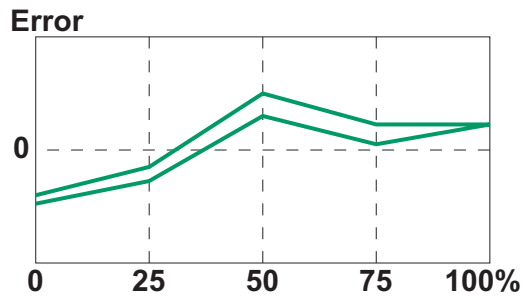

Adjustment

If the found error is outside acceptable limits (reject limits), the instrument needs adjustment. Activate one of MC2's error display modes to help you minimize the error (see chapter **Tools Menu** in part B).

Use the instrument's ZERO adjustment at lower end of the range. Adjust the higher end of the range with the instrument's SPAN adjustment. The two adjustment points do not necessarily need to be the end points of the instrument range. You may want to use other points to optimize the calibration at the most important part of the range. Note, however, that if the points are very close to each other, the error at other points of the range may be quite big (see **As Left Calibration** on next page).

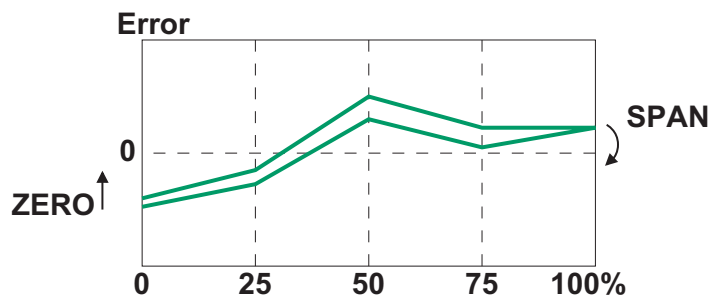

As Left Calibration

The As Left calibration document the state of the instrument after the possible adjustment. If the As Found calibration proves to be good and no adjustment is needed, you may omit the As Left calibration.

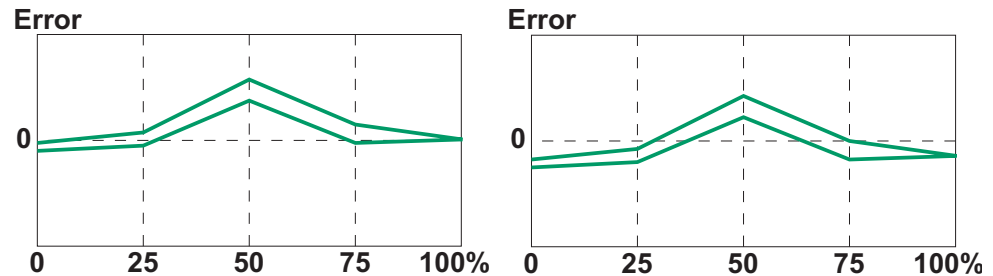

The pictures above display different As Left calibration graphs after two different kinds of adjustments.

In the leftmost picture, the error is minimized at the end points of the instrument range. This results in a relatively notable error in the middle of the span. If the middle of the span is the area, where the measurement is usually situated, then this method is not recommended.

The rightmost picture displays the error graph when the maximum error is minimized by "lowering the graph". As a result, the error minimum is at approx. 30 % and 70 % of the span.

Note that these adjustment strategies are just examples. There is an unlimited amount of "correct" ways to adjust an instrument.

Calibrating an Instrument

A Calibration Procedure Using MC2

The most convenient way to calibrate instruments with MC2 is using one of the error display modes described in chapter **Tools Menu** presented on page 67.

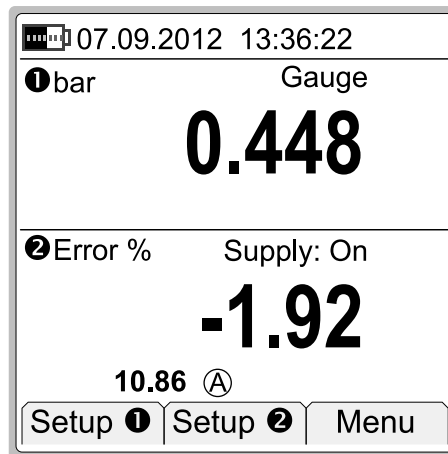

The picture above is an example where a pressure transmitter is calibrated using error percentage display mode for the output current. The additional info row displays the actual output current of the instrument. Another useful method, especially while adjusting the instrument, is displaying the error bar graph in the additional info row.

A typical calibration procedure using MC2 is as follows:

1. Make the required connections, configure MC2's windows to suit the needs of the instrument
2. Test the instrument, connections and calibrator settings by altering the instrument's input signal.
3. Start the calibration run by setting the instrument's input signal to a level needed for the first calibration point. Record the input and output signals and also the error value, if applicable. Advance to next calibration point.
4. When all points are done, do another repeat if needed or if adjust the instrument, if that is required.
5. When all repeats/adjustments are done, the calibration is ready.

Examples of Instrument Calibration

The following pages contain a few examples of how to calibrate an instrument using MC2.

When uncertain, consult Part B of this manual for information on how to connect instruments and configure the windows of MC2 to suit the instrument's needs.

The following calibration examples are presented in this manual:

- **Pressure Transmitters** on page 128,
- **Temperature Indicators and Recorders** on page 130,
- **Electrical Limit Switches** on page 132,
- **Temperature Sensors** on page 134 and
- **Pneumatic Pressure Transmitters and Converters** on page 136.

Warning!

Working with pressure instruments can be hazardous. Only qualified personnel may use pressure instruments and pressure sources. See pressure measurement related warnings in Part A of this manual.

Pressure Transmitters

This procedure suits all instruments with a pressure input and any kind of electrical output signal. Both the input and output signal range should be measurable with MC2.

All MC2 models (MC2-TE equipped with an external pressure module) are capable of calibrating a pressure transmitter.

Preparations

1. Connect the instrument's input to the selected pressure module (internal or external).
2. Connect a pressure source both to the instrument's input and to the pressure module.
3. Connect the instrument's output signal to the terminals in MC2.
4. Configure one of MC2's windows to measure pressure and the other to measure the electrical output signal of the instrument. If the output signal is current, select whether MC2 provides the supply voltage or not (see Current Measurement in Part B).
5. Test the connections.

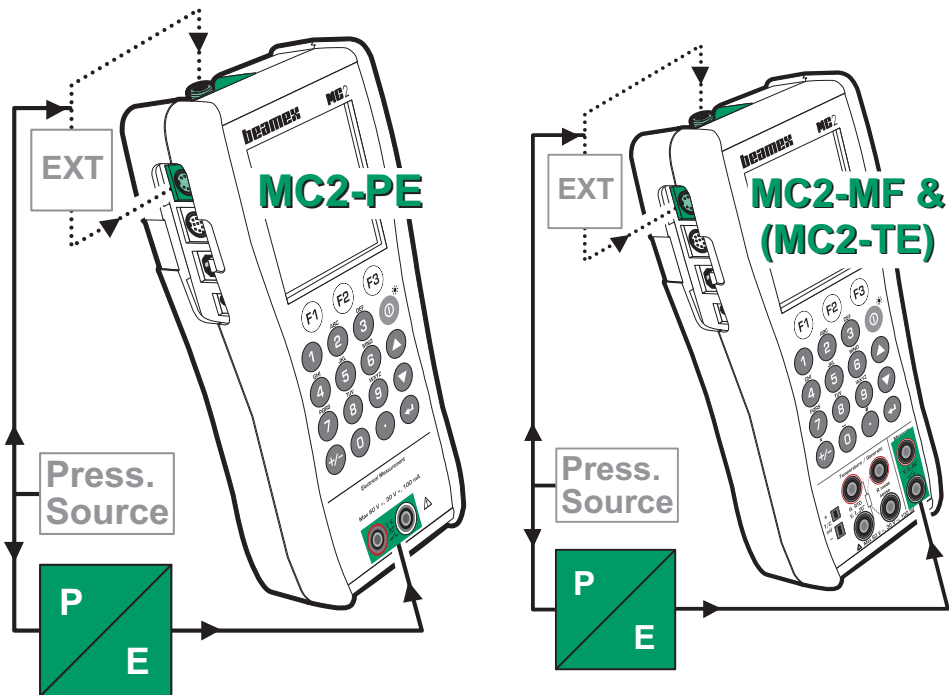

Calibration

1. Set the pressure using, e.g. a pressure pump.
2. Record the input and output signals and also the error value, if applicable.
3. Proceed to next calibration point (step 1) if applicable.
4. Continue by either adjusting the instrument, starting another

Hint!

These instructions can be adapted for any kind of transmitters. Change the input signal connections/settings according to the instruments input signal.

When calibrating another kind of pressure instrument, use this example as the source for the input signal part.

Temperature Indicators and Recorders

This procedure suits temperature indicators/recorders no matter if the sensor is an RTD or a thermocouple. The instruments input signal is simulated using MC2.

MC2-TE and MC2-MF models are capable of calibrating temperature indicators and recorders.

Preparations

1. Connect suitable terminals in MC2 to the input connectors of the indicator/recorder.
2. If the sensor to be simulated is a thermocouple, select one of the following reference junction methods:
 - MC2's internal reference junction is used.
 - The reference junction temperature is measured externally using an RTD connected to the RTD terminals.
 - The reference junction temperature is fixed to 0 °C.
 - The reference junction temperature is manually entered.

Additional information about Reference Junction compensation methods can be found in chapters

Internal Reference Junction on page 111 and
External Reference Junction on page 112.

3. If the sensor to be simulated is an RTD, the used wiring system depends on the instrument to be calibrated. Remember to only use the two leftmost RTD terminals in MC2.
6. Configure one of MC2's windows to simulate temperature (**T/C Sensor Simulation** or **RTD Sensor Simulation**). Test the connections.

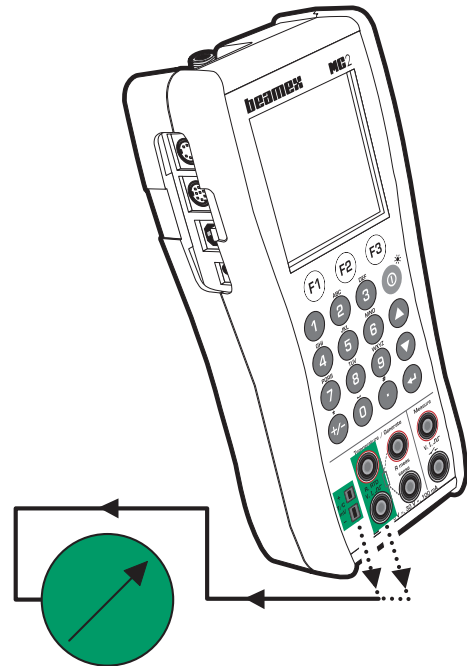

Calibration

1. Enter the temperature to be simulated There are two different strategies on how to set the temperature:
 - Adjust the simulated value until the reading of the indicator/recorder is exactly the same as the default output value for the current calibration point. This method is useful when calibrating analog indicators/recorders and the input signal can be fine adjusted.
 - Do not adjust the simulated value, but enter the actual reading as the output value. This method suits indicators with digital display. It is also handy when calibrating other types of indicators/recorders with an input signal that do not support fine adjustment (e.g. pressure indicators).
2. Record the input signal and output reading/display.
3. Proceed to next calibration point (step 1) if applicable.
4. Continue by either adjusting the instrument, starting another calibration repeat or ending the calibration.

Hint!

These instructions can be adapted for any kind of indicator/recorder. Change the input signal connections/settings according to the instrument's input signal.

When calibrating a temperature instrument with a detachable sensor (the input signal is simulated with MC2), use this example as the source for the input signal part.

Electrical Limit Switches

This procedure suits limit switches with an electrical input. MC2 generates the switch's input signal and measures the switch's state.

MC2-TE and MC2-MF models are capable of calibrating electrical limit switches.

Preparations

1. Connect the instrument's input to MC2's output terminals (see picture).
2. Connect the switch's output to the measuring terminals in MC2.
3. Configure one of MC2's windows to generate the electrical signal and the other to measure the switch's output.
4. Test the connections.

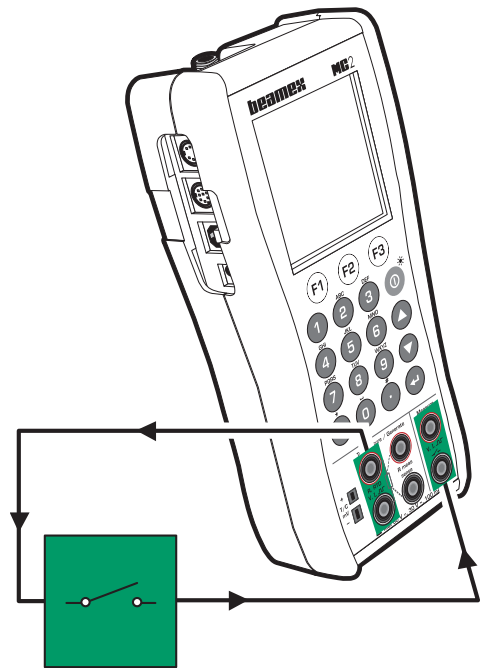

Calibration

1. Slowly increase the instrument's input signal until the switch actuates. See part B for help on how to change the generated value. The extra info row of the window configured to measure the switch's state displays the actuation point.
2. Continue by decreasing the input signal until the switch deactuates. The deactuation point is also displayed on the extra info row.
3. Record the actuation and the deactuation point.
4. Redo the test (step 1) if applicable.
5. Continue by either adjusting the instrument, starting another calibration repeat or ending the calibration

Note.

The slower you raise the input signal, the more accurate the observed actuation point is. Be equally careful when decreasing the input signal in order to get as accurate deactuation point as possible.

Hint!

These instructions can be adapted for any kind of switches. Change the input signal connections/settings according to the instrument's input signal.

When calibrating an electrical instrument and the input signal is generated with MC2, use this example as the source for the input signal part.

Temperature Sensors

This procedure suits temperature sensors no matter if they are RTDs or thermocouples. The sensor's output signal is measured with MC2. The reference temperature also measured with MC2.

MC2-TE and MC2-MF models are capable of calibrating a temperature sensors .

Remember the following conditions:

- If the sensor to be calibrated is a thermocouple, the reference thermometer needs to be an RTD sensor.
- If the sensor to be calibrated is an RTD sensor, the reference thermometer needs to be a thermocouple.

Preparations

1. Place the sensor of the instrument and the reference sensor into the calibration bath/dry block. Connect them to suitable terminals in MC2. Select one of the available reference junction methods for the thermocouple:
 - MC2's internal reference junction is used.
 - The reference junction temperature is fixed to 0 °C.
 - The reference junction temperature is manually entered.
 - The reference junction temperature is measured externally using an RTD connected to the RTD terminals.

See Part C for additional information concerning the reference junction methods.

2. Configure one of MC2's windows to measure T/C temperature and the other to measure RTD temperature.
3. Test the connections.

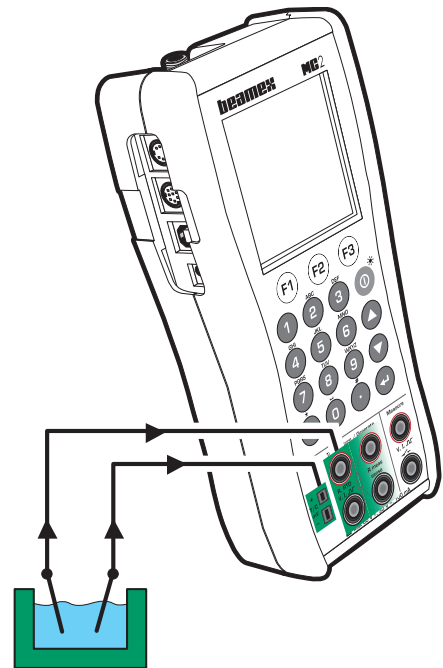

Calibration

1. Set the temperature of the bath/dry block to the required calibration point. Wait until the temperature stabilizes.
2. Record the input and output signals and also the error value, if applicable.
3. Proceed to next calibration point (step 1) if applicable.
4. Continue by either adjusting the instrument, starting another calibration repeat or ending the calibration.

Hint!

If one of the sensors cannot be detached from its transmitter, connect the transmitter's output signal to MC2's measuring terminals and use one of the error display modes to convert the (standard) output signal to a more usable format. See Part B for additional information concerning display modes.

Pneumatic Pressure Transmitters and Converters

This procedure suits all instruments with both a pressure input and a pressure output signal. Both the input and output signal range should be measurable with MC2.

To be able to perform the calibration, an internal pressure module need to be installed and an external pressure module need also be connected to MC2. The example picture below has the instrument's input connected to the internal pressure module and the instrument's output connected to the external pressure module. The pressure modules may also be used the other way. All that matters is that the pressure module's span and accuracy suits the pressure signal.

MC2-PE and MC2-MF models are capable of calibrating a pneumatic pressure transmitter/converter.

Preparations

1. Connect the instrument's input to the selected pressure module (internal or external).
2. Connect a pressure source both to the instrument's input and to the pressure module.
3. Connect the instrument's output to the selected pressure module (internal or external).
4. Configure one of MC2's windows to measure the input pressure and the other to measure the output pressure .
5. Test the connections.

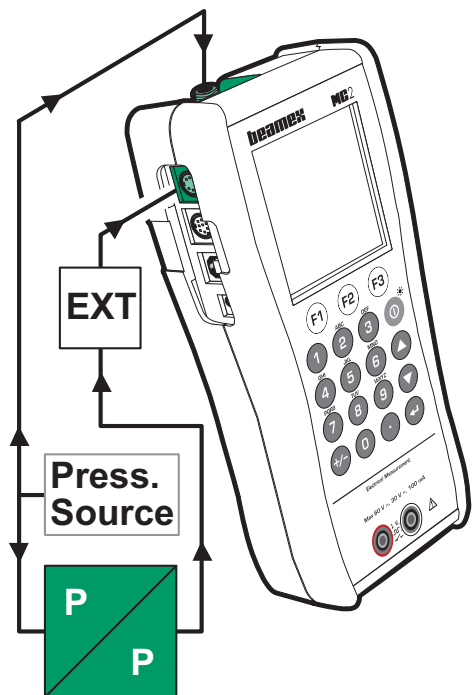

Calibration

1. Set the pressure using, e.g. a pressure pump.
2. Record the input and output signals and also the error value, if applicable.
3. Proceed to next calibration point (step 1) if applicable.
4. Continue by either adjusting the instrument, starting another calibration repeat or ending the calibration.

(Empty)

Appendixes

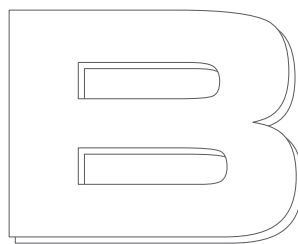
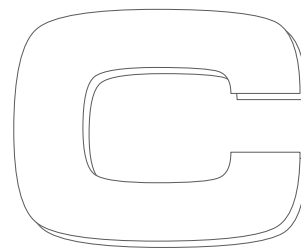
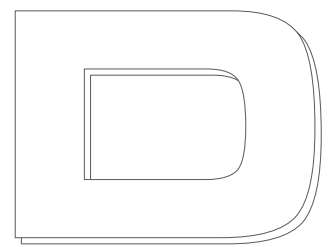

Appendix 1	
Technical Data	140
Appendix 2	
Index	158

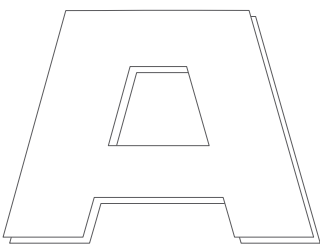

Appendix 1, Technical Data

MC2 General Specifications

Feature	Specification
Display	60 mm x 60 mm (2.36" x 2.36"), 160 x 160 pixels, back lit LCD
Weight	720 ... 830 g (1.59 ... 1.83 lbs), depending on model and installed pressure modules.
Dimensions	215 mm (8.5") x 102 mm (4") x 49 mm (1.9") (d/w/h)
Keyboard	Membrane keyboard
Battery type	Rechargeable NiMH, 4000 mAh, 3.6 VDC
Charging time	5 hours, with no load
Charger supply	100...240 VAC, 50-60 Hz
Battery operation	13 ... 24 hours in measurement mode, backlight off. 8 ... 12 hours when sourcing an average of 12 mA to loop, with backlight on.
... with optional Dry Battery cartridge and 4 Alkaline AA cells.	4 hours in measurement mode, backlight off. 2.5 hours when sourcing an average of 12 mA to loop, with backlight on.
Operating temperature	-10...50°C (14...122°F)
Operating temperature while charging batteries	0 ... 35°C (32...95°F)
Storage temperature	-20 to 60°C (-4 to 140°F)
Humidity	0 to 80% R.H. non condensing
Warmup time	Specifications valid after a 5 minute warmup period.
Max. input voltage	30 V AC, 60 V DC
Safety	Directive 73/23/EEC, EN 61010-1
EMC	Directive 89/336/EEC, EN 61326

Pressure Modules

Internal Pressure Modules (IPM)

Module ³	Unit	Range ²	Resolution	1 Year Uncertainty ¹
IPM200mC	kPa	±20	0.001	0.05% RDG + 0.05% FS
	mbar	±200	0.01	
	iwc	±80	0.01	
IPM2C	kPa	-100 ... 200	0.01	0.05% FS
	bar	-1 ... 2	0.0001	
	psi	-14.5 ... 30	0.001	
IPM20C	kPa	-100 ... 2000	0.1	0.05% FS
	bar	-1 ... 20	0.001	
	psi	-14.5 ... 300	0.01	
IPM160	MPa	0 ... 16	0.001	0.05% FS
	bar	0 ... 160	0.01	
	psi	0 ... 2400	0.1	

Term 'FS':

'FS' is the Full Scale of the positive side range. E.g. for ±200 mbar module, the Full Scale is 200 mbar.

Barometric option:

Enables also absolute pressure measurement for above pressure inputs. With barometric option add 0.1 kPa (0.0146 psi) uncertainty for absolute pressure measurement.

Feature	Specification
Temperature coefficient	< ±0.001 % RDG /°C outside 15 ... 35 °C. < ±0.0006 % RDG /°F outside 59 ... 95 °F
Maximum overpressure	Barometric Option: 1200 mbar abs (35.4 inHg abs) Others: 2 × Range
Pressure port	Barometric option: M5 (10/32") female IPM200mC, IPM2C and IPM20C: G 1/8" female with G 1/8 (ISO 228/1) 60° internal cone adapter INT 160: G 1/8" female (parallel)
Media compatibility	Wetted parts: AISI316 stainless steel, Nitrile rubber. Use of pressure media classified as dangerous is prohibited.
Supported pressure units	Pa, hPa, kPa, MPa, mbar, bar, lbf/ft2, psi, osi, gf/cm2, kgf/cm2, kgf/m2, kp/cm2, at, mmH2O, cmH2O, mH2O, iwc, ftH2O, mmHg, cmHg, mHg, inHg, mmHg(0°C), inHg(0°C), mmH2O(4°C), inH2O(4°C), ftH2O(4°C), inH2O(60°F), mmH2O(68°F), inH2O(68°F), ftH2O(68°F), torr, atm and user configurable units
Display update rate	2.5 / second

¹⁾ Uncertainty includes reference standard uncertainty, hysteresis, non-linearity, repeatability and typical long term stability for mentioned period (k=2).

²⁾ Every internal/external pressure module's range may be displayed also in absolute pressure if the Barometric Module (B) is installed.

³⁾ MC2 Calibrator can hold one internal pressure module and the optional internal barometric module.

External Pressure Modules (EXT), High Accuracy

Module	Unit	Range ³⁾	Resolution	Accuracy ¹⁾ (±)	1 Year Uncertainty ²⁾ (±)
EXT B	kPa a mbar a psi a	80 to 120 800 to 1200 11.6 to 17.4	0.01 0.1 0.001	0.03 kPa 0.3 mbar 0.0044 psi	0.05 kPa 0.5 mbar 0.0073 psi
EXT10mD	kPa diff mbar diff iwc diff	± 1 ± 10 mbar diff ± 4	0.001	0.05 % Span (Span = 20mbar)	0.05 % Span + 0.1 % RDG
EXT100m	kPa mbar iwc	0 to 10 0 to 100 0 to 40	0.0001 0.001 0.001	0.015 % FS + 0.0125 % RDG	0.025 % FS + 0.025% RDG
EXT400mC	kPa mbar iwc	± 40 ± 400 ± 160	0.001 0.01 0.001	0.01 % FS + 0.0125 % RDG	0.02 % FS + 0.025% RDG
EXT1C	kPa bar psi	± 100 ± 1 -14.5 to 15	0.001 0.00001 0.0001	0.007 % FS + 0.0125 % RDG	0.015 % FS + 0.025% RDG
EXT2C	kPa bar psi	-100 to 200 -1 to 2 -14.5 to 30	0.001 0.00001 0.0001	0.005 % FS + 0.01 % RDG	0.01 % FS + 0.025% RDG
EXT6C	kPa bar psi	-100 to 600 -1 to 6 -14.5 to 90	0.01 0.0001 0.001	0.005 % FS + 0.01 % RDG	0.01 % FS + 0.025% RDG
EXT20C	kPa bar psi	-100 to 2000 -1 to 20 -14.5 to 300	0.01 0.0001 0.001	0.005 % FS + 0.01 % RDG	0.01 % FS + 0.025% RDG
EXT60	kPa bar psi	0 to 6000 0 to 60 0 to 900	0.1 0.001 0.01	0.005 % FS + 0.0125 % RDG	0.01 % FS + 0.025% RDG
EXT100	MPa bar psi	0 to 10 0 to 100 0 to 1500	0.0001 0.001 0.01	0.005 % FS + 0.0125 % RDG	0.01 % FS + 0.025% RDG
EXT160	MPa bar psi	0 to 16 0 to 160 0 to 2400	0.0001 0.001 0.01	0.005 % FS + 0.0125 % RDG	0.01 % FS + 0.025% RDG
EXT250	MPa bar psi	0 to 25 0 to 250 0 to 3700	0.001 0.01 0.1	0.007 % FS + 0.0125 % RDG	0.015 % FS + 0.025% RDG
EXT600	MPa bar psi	0 to 60 0 to 600 0 to 9000	0.001 0.01 0.1	0.007 % FS + 0.01 % RDG	0.015 % FS + 0.025% RDG
EXT1000	MPa bar psi	0 to 100 0 to 1000 0 to 15000	0.001 0.01 0.1	0.007 % FS + 0.01 % RDG	0.015 % FS + 0.025% RDG

Term 'FS':

'FS' is the Full Scale of the positive side range. E.g. for ±200 mbar module, the Full Scale is 200 mbar.

- 1) Accuracy includes hysteresis, nonlinearity, repeatability and reference standard uncertainty (k=2).
- 2) 1 Year Uncertainty includes hysteresis, nonlinearity, repeatability and typical long term stability for mentioned period (k=2).
- 3) Every internal/external pressure module's range may be displayed also in absolute pressure if the Barometric Module (B) is installed.

Feature	Specification
Temperature coefficient	EXT10mD: < ±0.002 % Span/°C outside 15 ... 35 °C (59... 95 °F) All other modules: <±0.001 % Rdg/°C outside 15 ... 35 °C (59... 95 °F)
Maximum overpressure	See table below
Pressure port	EXT B: M5 (10/32") female EXT10mD: Two M5 (10/32") female threads. Hose nipples for hoses with an inner diameter of approx. 3.2 mm (1/8") included. Hose included. EXT100m, EXT400mC, EXT1C, EXT2C, EXT6C, EXT20C: G1/8" (ISO228/1) female. A conical 1/8" BSP male with 60° internal cone adapter included for Beamex hose set. EXT60 to EXT1000 G 1/4" (ISO228/1) male
Wetted parts	AISI316 stainless steel, Hastelloy, Nitrile rubber.
Pressure media	EXT B to EXT 6C: Dry clean air or other clean, inert, non-toxic, non-corrosive gases EXT60 to EXT1000: Clean, inert, non-toxic, non-corrosive gases or liquids Use of pressure media classified as dangerous is prohibited.
Dimensions, length / width / depth	145 mm / 45 mm / 55 mm (5.7" / 1.8" / 2.2")
Weight	0.5 kg (1.1 lb)
Operating temperature	-10...+50°C (14...122 °F)
Storage temperature	-20...+60°C (-4...140 °F)
Humidity range	0...80 % R.H. non-condensing

Module	Maximum overpressure	Module	Maximum overpressure
EXT B	1200 mbar abs 35.4 inHg abs	EXT20C	40 bar 600 psi
EXT10mD	200 mbar 80 iwc	EXT60	120 bar 1800 psi
EXT100m	200 mbar 80 iwc	EXT100	200 bar 3000 psi
EXT400mC	800 mbar 320 iwc	EXT160	320 bar 4800 psi
EXT1C	2 bar 30 psi	EXT250	500 bar 7400 psi
EXT2C	4 bar 60 psi	EXT600	900 bar 13000 psi
EXT6C	12 bar 180 psi	EXT1000	1000 bar 15000 psi

Note.

The sensor unit of EXT1000/EXT1000-IS withstands 10000 full range pressure cycles. Exceeding the maximum amount of pressure cycles may result in leakage or even explosion.

External Pressure Modules (EXT), Standard Accuracy

Module	Unit	Range ²	Resolution	1 Year Uncertainty ¹
EXT200mC-s	kPa	±20	0.001	0.05% RDG + 0.05% FS
	mbar	±200	0.01	
	iwc	±80	0.01	
EXT2C-s	kPa	-100 ... 200	0.01	0.05% FS
	bar	-1 ... 2	0.0001	
	psi	-14.5 ... 30	0.001	
EXT20C-s	kPa	-100 ... 2000	0.1	0.05% FS
	bar	-1 ... 20	0.001	
	psi	-14.5 ... 300	0.01	
EXT160-s	MPa	0 ... 16	0.001	0.05% FS
	bar	0 ... 160	0.01	
	psi	0 ... 2400	0.1	

Term 'FS':

'FS' is the Full Scale of the positive side range. E.g. for ±200 mbar module, the Full Scale is 200 mbar.

Feature	Specification
Temperature coefficient	<±0.001 % Rdg/°C outside 15...35°C (59 ... 95 °F)
Maximum overpressure	2 × Range
Pressure port	EXT160-s: G 1/8" female (parallel) All others: G1/8" (ISO228/1) female. A conical 1/8" BSP male with 60° internal cone adapter included for Beamex hose set.
Wetted parts	AISI316 stainless steel, Hastelloy, Nitrile rubber.
Pressure media	EXT200mC-s and EXT2C-s: Dry clean air or other clean, inert, non-toxic, non-corrosive gases EXT20C-s and EXT160-s: Clean, inert, non-toxic, non-corrosive gases or liquids Use of pressure media classified as dangerous is prohibited.
Dimensions, length / width / depth	145 mm / 45 mm / 55 mm (5.7" / 1.8" / 2.2")
Weight	0.5 kg (1.1 lb)
Operating temperature	-10...+50°C (14... 122 °F)
Storage temperature	-20...+60°C (-4... 140 °F)
Humidity range	0...80 % R.H. non-condensing

1) Uncertainty includes reference standard uncertainty, hysteresis, non-linearity, repeatability and typical long term stability for mentioned period (k=2).

2) Every internal/external pressure module's range may be displayed also in absolute pressure if the Barometric Module (B) is installed.

Electrical Measurements

The following electrical measurements are available in all MC2 models.

Voltage Measurement

Full Range: -1 ... 60 V DC		
Sub Range	Resolution	1 Year Uncertainty ¹⁾
± 0.25 V	0.001mV	0.02 % RDG + 5 µV
±(0.25 ... 1 V)	0.01 mV	(same as above)
1 ... 25 V	0.1 mV	0.02 % RDG + 0.25 mV
25 ... 60 V	1 mV	(same as above)

Feature	Specification
Temperature coefficient	Add 0.0015 % RDG /°C to spec. outside 18 ... 28°C Add 0.0008 % RDG /°F to spec. outside 64.4 ... 82.4°F
Input impedance	>1 Mohm
Supported units	V, mV, µV
Display update rate	3 / second

Current Measurement

Full Range: ±100 mA		
Sub Range	Resolution	1 Year Uncertainty ¹⁾
±25mA	0.0001 mA	0.02 % RDG + 1.5 µA
±(25..100 mA)	0.001 mA	(same as above)

Feature	Specification
Temperature coefficient	Add 0.0015 % RDG /°C to spec. outside 18 ... 28°C Add 0.0008 % RDG /°F to spec. outside 64.4 ... 82.4°F
Input impedance	< 7.5 ohm
Supported units	mA, µA
Display update rate	3 / second

Loop Supply	Specification
Max. output current	> 25 mA, short circuit protected
Output voltage	24 V ± 10%
Output impedance in HART® compatible mode	300 ohm ± 20%

¹⁾ Uncertainty includes reference standard uncertainty, hysteresis, nonlinearity, repeatability and typical long term stability for mentioned period. (k=2)

Frequency Measurement

Full Range: 0.0027 ... 50 000 Hz		
Sub Range	Resolution	1 Year Uncertainty ¹⁾
0.0027 .. 0.5 Hz	0.000001 Hz	0.01 % RDG
0.5 .. 5 Hz	0.00001 Hz	(same as above)
5 .. 50 Hz	0.0001 Hz	(same as above)
50 .. 500 Hz	0.001 Hz	(same as above)
500 .. 5000 Hz	0.01 Hz	(same as above)
5000 .. 50000 Hz	0.1 Hz	(same as above)

Feature	Specification
Temperature coefficient	Specification valid from -10 ... 50°C (14 ... 122°F)
Input impedance	> 1 Mohm
Trigger level	-1... 14 V in 1 V steps and open collector inputs
Minimum signal amplitude	2 Vpp (< 10 kHz), 3 Vpp (10...50 kHz)
Supported units	Hz, kHz, cph, cpm, 1/Hz (s), 1/kHz (ms), 1/MHz (µs)
Gate period	267 ms + 1 signal period

Pulse Counting

Feature	Specification
Range	0 to 9,999,999 pulses
Input impedance	> 1 Mohm
Trigger level	-1... 14 V in 1 V steps and open collector inputs
Minimum signal amplitude	2 Vpp (pulse length > 50 µs) 3 Vpp (pulse length 10...50 µs)

Switch Test

Potential free contacts		
Test Voltage /	3 V ...	or 24 V
Current	0.13 mA ...	or 35 mA
Trigger level	1 V ...	or 2 V

Voltage level detection	
Input impedance	> 1 Mohm
Trigger level	-1... 14 V in 1 V steps

¹⁾ Uncertainty includes reference standard uncertainty, hysteresis, nonlinearity, repeatability and typical long term stability for mentioned period. (k=2)

Electrical Generation, Sensor Measurement and Simulation

The following features are available in model MC2-MF and model MC2-TE.

mV Measurement (T/C-Terminals)

Range	Resolution	1 Year Uncertainty ¹⁾
-25 ... 150 mV	0.001mV	0.02 % RDG + 4 μ V

Feature	Specification
Temperature coefficient	Add 0.0015 % RDG /°C to spec. outside 18 ... 28°C Add 0.0008 % RDG /°F to spec. outside 64.4 ... 82.4°F
Input impedance	>10 Mohm
Supported units	V, mV, μ V
Display update rate	3 / second

mV Generation (T/C-Terminals)

Range	Resolution	1 Year Uncertainty ¹⁾
-25 ... 150 mV	0.001 mV	0.02 % RDG + 4 μ V

Feature	Specification
Temperature coefficient	Add 0.0015 % RDG /°C to spec. outside 18 ... 28°C Add 0.0008 % RDG /°F to spec. outside 64.4 ... 82.4°F
Max. load current	5 mA
Load effect	< 5 μ V/mA
Supported units	V, mV, μ V

¹⁾ Uncertainty includes reference standard uncertainty, hysteresis, nonlinearity, repeatability and typical long term stability for mentioned period. (k=2)

Voltage Generation

Full Range: -3 ... 12 V		
Sub Range	Resolution	1 Year Uncertainty ¹
-3 ... -0.25 V	0.1 mV	0.02 % RDG + 0.1 mV
± 0.25 V	0.01 mV	(same as above)
0.25 ... 12 V	0.1 mV	(same as above)

Feature	Specification
Temperature coefficient	Add 0.0015 % RDG /°C to spec. outside 18 ... 28°C Add 0.0008 % RDG /°F to spec. outside 64.4 ... 82.4°F
Max. load current	5 mA
Load effect	< 50 uV/mA
Supported units	V, mV, µV

mA Generation (Source/Sink)

Range	Resolution	1 Year Uncertainty ¹
0... 25 mA	0.0001mA	0.02 % RDG + 1.5 µA

Feature	Specification
Temperature coefficient	Add 0.0015 % RDG /°C to spec. outside 18 ... 28°C Add 0.0008 % RDG /°F to spec. outside 64.4 ... 82.4°F
Max load impedance (source)	750 ohm @20 mA, 600 ohm @25 mA
Max loop voltage (sink)	60 V
Supported units	mA, µA

¹) Uncertainty includes reference standard uncertainty, hysteresis, nonlinearity, repeatability and typical long term stability for mentioned period. (k=2)

Resistance Measurement

Full Range: 0 ... 4000 ohm		
Sub Range	Resolution	1 Year Uncertainty ⁽¹⁾
0 ... 250 ohm	1 mohm	4 wire connection: 0.02 % RDG + 3.5 mohm 3 wire connection: 0.02 % RDG + 13.5 mohm
250 ... 2650 ohm	10 mohm	(same as above)
2650 ... 4000 ohm	100 mohm	(same as above)

Feature	Specification
Temperature coefficient	Add 0.0015 % RDG /°C to spec. outside 18 ... 28°C Add 0.0008 % RDG /°F to spec. outside 64.4 ... 82.4°F
Measurement current	Pulsed, bi-directional 1 mA (0 ... 500 ohm), 0.2 mA (>500 ohm).
Supported units	ohm, kohm
Display update rate	3 / second

Resistance Simulation

Full Range: 0 ... 4000 ohm		
Sub Range	Resolution	1 Year Uncertainty ^{(1) (2)}
0 ... 400 ohm	10 mohm	0.04 % RDG or 30 mohm (Whichever is greater)
400 ... 4000 ohm	100 mohm	(same as above)

Feature	Specification
Temperature coefficient	Add 0.0015 % RDG /°C to spec. outside 18 ... 28°C Add 0.0008 % RDG /°F to spec. outside 64.4 ... 82.4°F
Max. Resistance excitation current	5 mA (0 ... 650 ohm) $I_{exc} \cdot R_{sim} < 3.25 \text{ V}$ (650 ... 4000 ohm)
Settling time (pulsed currents)	1 ms
Supported units	ohm, kohm

¹⁾ Uncertainty includes reference standard uncertainty, hysteresis, nonlinearity, repeatability and typical long term stability for mentioned period. (k=2)

²⁾ Specification valid with an excitation current
>0.2 mA (0...400 ohm),
>0.1 mA (400...4000 ohm)

Frequency Generation

Full Range: 0.0005 ... 10000 Hz		
Sub Range	Resolution	1 Year Uncertainty ¹⁾
0.0005 ... 0.5 Hz	0.000001 Hz	0.01 % RDG
0.5 ... 5 Hz	0.00001 Hz	(same as above)
5 ... 50 Hz	0.0001 Hz	(same as above)
50 ... 500 Hz	0.001 Hz	(same as above)
500 ... 5000 Hz	0.01 Hz	(same as above)
5000 ... 10000 Hz	0.1 Hz	(same as above)

Feature	Specification
Temperature coefficient	Specification valid from -10 to 50°C (14...122°F)
Max. load current	5 mA
Output amplitude positive square wave	0 .. 12 Vpp ±(0.2 V+5%)
Output amplitude symmetric square wave	0 .. 6 Vpp ±(0.2 V+5%)
Duty Cycle	1 ... 99 % (0.0009 ... 500 Hz), high/low time: minimum 25µs, maximum 1165 s
Jitter	< 0.28 µs
Supported units	Hz, kHz, cph, cpm, 1/Hz (s), 1/kHz (ms), 1/MHz (µs)

Pulse Generation

Feature	Specification
Range	0 to 9 999 999 pulses
Resolution	1 pulse
Max. load current	5 mA
Output amplitude positive pulse	0 .. 12 Vpp ±(0.2 V+5%)
Output amplitude symmetric pulse	0 .. 6 Vpp ±(0.2 V+5%)
Pulse frequency	0.0005 ... 10000 Hz
Duty Cycle	1 ... 99 % (0.0009 ... 500 Hz), high/low time: minimum 25µs, maximum 1165 s

¹⁾ Uncertainty includes reference standard uncertainty, hysteresis, nonlinearity, repeatability and typical long term stability for mentioned period. (k=2)

Temperature Measurement and Simulation

The following features are available in model MC2-MF and model MC2-TE.

RTD Measurement and Simulation

Common features for RTDs available as standard:

Feature	Specification
Temperature coefficient	< ±0.0015% of resistance / °C outside of 18...28°C < ±0.0008% of resistance / °F outside of 64.4 ...82.4°F
Supported units	°C, °F, K
Measurement current	Pulsed, 1 mA (0..500 ohm), 0.2 mA (>500 ohm).
Display update rate (measurement)	3 / second
Max. Resistance excitation current (simulation)	5 mA (0 ... 650 ohm) $I_{exc} \cdot R_{sim} < 3.25 \text{ V}$ (650 ... 4000 ohm)

Pt50 ... Pt1000

Full Range: -200 ... 850 °C		
Sub Range	Resolution	1 Year Uncertainty ⁽¹⁾
-200 ... 200 °C	0.01 °C	4-wire measurement: 0.1 °C Simulation ⁽²⁾ : 0.15 °C
200 ... 600 °C	0.01 °C	4-wire measurement: 0.2 °C Simulation ⁽²⁾ : 0.25 °C
600 ... 800 °C	0.01 °C	4-wire measurement: 0.03 °C Simulation ⁽²⁾ : 0.35 °C

¹⁾ Uncertainty includes reference standard uncertainty, hysteresis, nonlinearity, repeatability and typical long term stability for mentioned period. (k=2)

²⁾ Specification valid with an excitation current
>0.2 mA (0...400 ohm),
>0.1 mA (400...4000 ohm)

Ni 100

Range	Resolution	1 Year Uncertainty ¹
-60 ... 180 °	0.01 °C	4-wire measurement: 0.1 °C Simulation ² : 0.15 °C

Ni 120

Range	Resolution	1 Year Uncertainty ¹
-80 ... 260 °C	0.01 °C	4-wire measurement: 0.1 °C Simulation ² : 0.15 °C

Cu 10

Range	Resolution	1 Year Uncertainty ¹
-200 ... 260 °C	0.01 °C	4-wire measurement: 0.2 °C Simulation ² : 0.8 °C

RTD Types Available as Standard

- Pt50 (385)
- Pt100 (385)
- Pt200 (385)
- Pt400 (385)
- Pt500 (385)
- Pt1000 (385)
- Pt100 (3926)
- Pt100 (391)
- Pt100 (375)
- Pt100 (3923)
- Ni100 (618)
- Ni120 (672)
- Cu10 (427)

¹) Uncertainty includes reference standard uncertainty, hysteresis, nonlinearity, repeatability and typical long term stability for mentioned period. (k=2)

²) Specification valid with an excitation current
>0.2 mA (0...400 ohm),
>0.1 mA (400...4000 ohm)

RTD Types Available as Option

- Pt25 (3926)
- Pt200 (3926)
- Pt470 (3926)
- Pt500 (3926)
- Pt50 (3916)
- Pt100 (3916)
- Pt200 (3916)
- Pt400 (3916)
- Pt500 (3916)
- Pt1000 (3916)
- Pt25 (391)
- Pt120 (391)
- Pt130 (391)
- Pt500 (391)
- Pt1000 (375)
- Pt100 (389)
- Pt10 (3923)
- Pt50 (3924)
- Pt100 (3924)
- Pt200 (3924)
- Pt500 (3924)
- Pt1000 (3924)
- Ni50 (618)
- Ni120 (618)
- Ni1000 (618)
- Ni50 (672)
- Ni50 (672)
- Ni100 (672)
- Ni1000 (672)
- NiFe604 (518)
- NiFe1000 (527)
- NiFe2000 (527)
- NiFe3000 (262)
- Cu100 (427)
- Cu10 (426)
- Cu50 (426)
- Cu53 (426)
- Cu100 (426)
- Cu 10M (428)
- Cu 50M (428)
- Cu 100M (428)
- Cu 10M (426)
- Cu 50M (426)
- Cu 53M (426)
- Cu 100M (426)

Thermocouple Measurement and Simulation

Common features for thermocouple types available as standard:

Feature	Specification
Temperature coefficient	< ±0.0015% of thermovoltage / °C outside of 18...28°C < ±0.0008% of thermovoltage / °F outside of 64.4 ...82.4°F
Supported units	°C, °F, K
Input impedance (measurement)	>10 Mohm
Display update rate (measurement)	3 / second
Max. load current (generation)	5 mA
Load effect (generation)	< 5µV/mA

Type B⁽²⁾

Full Range: 0 ... 1820 °C		
Sub Range	Resolution	1 Year Uncertainty ⁽¹⁾ (±)
0 ... 200	0.01 °C	⁽³⁾
200 ... 400	0.01 °C	2.0 °C
400 ... 1820	0.01 °C	1.0 °C

Type R⁽²⁾

Full Range: -50 ... 1768		
Sub Range	Resolution	1 Year Uncertainty ⁽¹⁾ (±)
-50 ... 0	0.01 °C	1.0 °C
0 ... 100	0.01 °C	0.8 °C
100 ... 1768	0.01 °C	0.6 °C

- 1) Uncertainty includes reference standard uncertainty, hysteresis, nonlinearity, repeatability and typical long term stability for mentioned period. (k=2).
Uncertainty does not include reference junction uncertainty.
- 2) IEC 584, NIST MN 175, BS 4937, ANSI MC96.1
- 3) ±0.02 % of thermovoltage + 4 µV

Type S⁽²⁾

Full Range: -50 ... 1768		
Sub Range	Resolution	1 Year Uncertainty ⁽¹⁾ (±)
-50 ... 0	0.01 °C	1.0 °C
0 ... 1768	0.01 °C	0.7 °C

Type E⁽²⁾

Full Range: -270 ... 1000 °C		
Sub Range	Resolution	1 Year Uncertainty ⁽¹⁾ (±)
-270 ... 200	0.01 °C	⁽³⁾
200 ... 1000	0.01 °C	0.25 °C

Type J⁽²⁾

Full Range: -210 ... 1200 °C		
Sub Range	Resolution	1 Year Uncertainty ⁽¹⁾ (±)
-210 ... 1200	0.01 °C	0.3 °C

Type K⁽²⁾

Full Range: -270 ... 1372 °C		
Sub Range	Resolution	1 Year Uncertainty ⁽¹⁾ (±)
-270 ... -200	0.01 °C	⁽³⁾
-200 ... 1000	0.01 °C	0.3 °C
1000 ... 1372	0.01 °C	0.4 °C

Type N⁽²⁾

Full Range: -270 ... 1300 °C		
Sub Range	Resolution	1 Year Uncertainty ⁽¹⁾ (±)
-270 ... -200	0.01 °C	⁽³⁾
-200 ... 1300	0.01 °C	0.4 °C

¹⁾ Uncertainty includes reference standard uncertainty, hysteresis, nonlinearity, repeatability and typical long term stability for mentioned period. (k=2).
Uncertainty does not include reference junction uncertainty.

²⁾ IEC 584, NIST MN 175, BS 4937, ANSI MC96.1

³⁾ ±0.02 % of thermovoltage + 4 µV

Type T⁽²⁾

Full Range: -270 ... 400 °C		
Sub Range	Resolution	1 Year Uncertainty ⁽¹⁾ (±)
-270 ... -200	0.01 °C	⁽³⁾
-250 ... 100	0.01 °C	0.3 °C
100 ... 400	0.01 °C	0.2 °C

Type U⁽⁴⁾

Full Range: -200 ... 600 °C		
Sub Range	Resolution	1 Year Uncertainty ⁽¹⁾ (±)
-200 ... -100 °C	0.01 °C	0.3 °C
-100 ... 600 °C	0.01 °C	0.4 °C

Type L⁽⁴⁾

Range	Resolution	1 Year Uncertainty ⁽¹⁾ (±)
-200 ... 900	0.01 °C	0.25 °C

Type C⁽⁵⁾

Full Range: 0 ... 2315 °C		
Sub Range	Resolution	1 Year Uncertainty ⁽¹⁾ (±)
0 ... 1000	0.01 °C	0.4 °C
1000 ... 2000	0.01 °C	0.8 °C
2000 ... 2315	0.01 °C	1.2 °C

Type G⁽⁶⁾

Full Range: 0 ... 2315 °C		
Sub Range	Resolution	1 Year Uncertainty ⁽¹⁾ (±)
0 ... 100	0.01 °C	⁽³⁾
100 ... 2315	0.01 °C	1.0 °C

- 1) Uncertainty includes reference standard uncertainty, hysteresis, nonlinearity, repeatability and typical long term stability for mentioned period. (k=2).
Uncertainty does not include reference junction uncertainty.
- 2) IEC 584, NIST MN 175, BS 4937, ANSI MC96.1
- 3) ±0.02 % of thermovoltage + 4 µV
- 4) DIN 43710
- 5) ASTM E 988 - 96
- 6) ASTM E 1751 - 95e1

Type D⁵

Full Range: 0 ... 2315 °C		
Sub Range	Resolution	1 Year Uncertainty ⁽¹⁾ (±)
0 ... 1000 °C	0.01 °C	0.4 °C
1000 ... 2000 °C	0.01 °C	0.8 °C
2000 ... 2315 °C	0.01 °C	1.2 °C

Thermocouple Types Available as Option

- K+/Au0.07Fe ⁽⁶⁾
- Ni18Mo/Ni0.8Co ⁽⁶⁾
- Platinel II ⁽⁶⁾
- Au/Pt ⁽⁶⁾
- Pt40Rh/Pt20Rh ⁽⁶⁾
- Ir40Rh/Ir ⁽⁶⁾
- Pt5Mo/Pt0.1Mo ⁽⁶⁾

Internal Reference Junction

Range	1 Year Uncertainty ⁽¹⁾ (±)
-10 ... 50 °C	0.25 °C

¹⁾ Uncertainty includes reference standard uncertainty, hysteresis, nonlinearity, repeatability and typical long term stability for mentioned period. (k=2).
Uncertainty does not include reference junction uncertainty.

⁵⁾ ASTM E 988 - 96

⁶⁾ ASTM E 1751 - 95e1

All specifications are subject to change without prior notice

Appendix 2, Index

2

2-wire system..... 117

A

About MC2, Window 96
 About This Manual 3
 Acknowledging Alarms..... 69, 70
 Additional Info Row 90
 Bar Graph 93
 Barometric Pressure 92
 Clearing 93
 Cumulative Average 91
 Deviation Reference 91
 Difference Measurement 91
 Feedback Measurement..... 92
 Icons 90
 Internal Temperature 91
 Maximum value 90
 Maximum-Minimum 91
 Minimum value..... 90
 Normal Reading..... 91
 Pulses Done 93
 Pulses Left..... 93
 Rate of Change 90
 Redundant Measurement..... 91
 Redundant Reference 91
 Resetting Calculations..... 93
 RJ Temperature
 Measurement..... 92
 RTD Measurement 92
 Sensor Resistance 92
 Thermovoltage Measurement..... 92
 Additional Information 107
 Adjustment of Instruments 124
 Alarms 69
 Acknowledging 70
 Acknowledging 69
 Resetting..... 70

As Found calibration..... 124
 As Left calibration..... 125
 Auto-off Delays..... 99

B

Bag 26
 Bar Graph 93
 Barometric Pressure..... 92
 Basic Mode, Defined 37
 Batteries..... 11, 25
 Charging 12
 Removing/Replacing 13

C

Calibration
 Adjustment..... 124
 As Found 124
 As Left 125
 Examples 127
 Generally 122
 Phases..... 123
 Pneumatic Pressure
 Transmitter 136
 Pressure Converter 136
 Pressure Electrical Limit
 Switch 132
 Pressure Transmitters 128
 Procedure, Defined 126
 Switch 132
 Temperature Indicators 130
 Temperature Recorders 130
 Temperature Sensor 134
 Calibration Points, Custom 101
 Calibrator
 Recalibration..... 100
 Capacity indication 14
 Carrying Case 26
 Case 26
 Change Rate 90
 Resetting 93

Changing EXT Module	
Basic Mode	45
Changing	
Generation/Simulation	
Values	55
Charger	33
Check Boxes	24
Cleaning MC2	34
Clearing the Additional Info	
Row	93
Communication	15
Configuration Windows	20
Connecting/Disconnecting a	
Pressure Module	45
Connections	6
External Pressure Modules	7
Internal Pressure Modules	7
Connectors	8
Contrast of the Display	9
Cumulative Average	91
Current Generation	57
Current Measurement	41
Customizing	
Auto Off Delays	99
Date and Time Format	98
Language	99
Net Frequency	99
Owner Info	99
Pressure Units	106
Temperature Scale	99
Temperaure Units	99
Test Point Sets	101
Transfer Functions	103
User Setups	97
Volume	99
D	
<hr/>	
Damping	70
Date Format	98
Deviation Measurement	87
Deviation Reference	91
Difference Measurement	89, 91
Display	
Contrast	9
Display Modes	81
Error %	82
Error in Input Units	83
Error in Output Units	84
Percentage	85
Scaling	86
Driver for USB	15
Dry Batteries	25

E

<hr/>	
Electrical Limit Switch	
Calibration	132
Entering	
Generation/Simulation	
Values	55
Error %	82
Error in Input Units	83
Error in Output Units	84
Error situations in	
thermocouple measurement	115
EXT Connector	8
EXT Module	
Changing	45
External Pressure Modules	7
External Reference Junction	112
Extra Info Row	90

F

<hr/>	
Feedback Measurement	92
Fields	
Check Boxes	24
Numeric Fields	21
Selection Lists	23
Text Fields	22
Firmware	
Basic Mode	17
Check Boxes	24
Configuration Windows	20
Function Keys	19
Menu	19
Numeric Fields	21
Selection Lists	23
Status Bar	18
Text Fields	22
Updating	17, 33
User Interface	18
Frequency Generation	59
Frequency Measurement	43
Function Info, Basic Mode	68
Function Keys	19

G

General Settings 99
 Generating (see also
 Simulating)
 Current 57
 Entering Values 55
 Frequency 59
 General Description 54
 Manual Stepping 55
 Pulses 60
 Spinning 55
 Voltages 66

H

Hardware 5

I

Icons 90
 Identifying MC2 Model 2
 Internal Pressure Modules 141, 7
 Internal Reference Junction 111
 Internal Temperature 91

K

Keyboard
 Arrow Keys 10
 Backlight Key 10
 Enter Key 10
 Function Keys 10
 Numeric Keys 10
 On/Off Key 10

L

Language 99
 Leak Test 71
 Limit Switch Calibration 132

M

Manual Stepping 55, 78
 Maximum value 90
 Maximum Value
 Resetting 93
 Maximum-Minimum 91
 MC2
 Identifying the Model 2

Measurement

 Test Diode Connections 118

Measuring

 Current 41
 Frequencies 43
 General Description 39
 Pressure 44
 Pulse Counting 47
 Resistance 48
 Switch State Sensing 49
 Voltages 53

Memory 9, 97, 102, 105

Minimum value 90

Minimum Value

 Resetting 93

Model, Identifying 2

N

Net Frequency 99

Normal Reading 91

Numeric Fields 21

O

Option Connector 8

Options 25

 Carrying Case 26

 Dry Batteries 25

 EXT Connection Cable 26

 Pressure Hose 25

 Pressure Modules 25

 Thermocouple Mini Plugs 26

Owner 99

P

Parallel Functions in MC2 119

PC Communication, Driver 15

Percentage Display 85

Pneumatic Pressure

 Transmitter Calibration 136

Power Connector 8

Pressure

 Module Names 109

 Pressure Types 108

 Square Rooting Instruments 110

Pressure Converter

 Calibration 136

 Pressure Hose 25

 Pressure Measurement 44

Pressure Module

 Connecting/Disconnecting 45

 Zeroing 46

Pressure Modules

Barometric	7	User Setups	97
Connections	7	Volumes	99
External	7	Simulating (see also	
Gauge	7	Generating)	
Pressure Transmitter		Resistance	61
Calibration	128	RTD Sensors	62
Pressure Units, Custom	106	Thermocouples	64
Pulse Counting	47	Simultaneous	
Pulse Generation	60	measurement/generation/sim	
Pulses Done	93	ulation	119
Pulses Left	93	Sinking Current	57
		Sleep Mode	36
R		Software	17, 33
		Sourcing Current	57
		Special Generations	
Ramping	76	Manual Stepping	78
Rate of Change	90	Ramping	76
Resetting	93	Stepping	73
Recalibrating MC2	100	Special Measurements	81
Redundant Measurement	88, 91	Damping	70
Redundant Reference	91	Deviation Measurement	87
Reference Junction		Difference Measurement	89
External	112	Redundant Measurement	88
Internal	111	Tare	87
Modes	111, 112	Specifications	
Related Information	107	Current Generation	148
Resetting Alarms	70	Current Measurement	145
Resetting MC2	33	Frequency Generation	150
Resetting min/max/rate		Frequency Measurement	146
Calculations	93	General	140
Resistance Simulation	61	Internal Reference Junction	157
Resistance Measurement	48	Milliamp Generation	148
RJ Temperature		Millivolt Generation	147
Measurement	92	Millivolt Measurement	147
RTD Connections	116	Pressure Modules, External,	
RTD Measurement	92	High Accuracy	142
RTD Sensor Simulation	62	Pressure Modules, External,	
RTD Sensor Types		Standard Accuracy	144
Optional	153	Pressure Modules, Internal	141
Standard	152	Pulse Counting	146
		Pulse Generation	150
S		Resistance Measurement	149
		Resistance Simulation	149
		RTD	
Safety	27	Cu10	152
Scaling	86	Ni100	152
Selection Lists	23	Ni120	152
Sensor Resistance	92	RTD Measurement	151
Service	33	RTD Simulation	151
Settings		RTDPlatinum	151
Auto-off Delays	99	Switch Test	146
Date and Time (Format)	98	Thermocouple	
Language	99	Type B	154
Net Frequency	99	Type C	156
Owner	99	Type D	157
Temperature Scale	99	Type E	155
Temperature Unit	99	Type G	156
		Type J	155
		Type L	156

- Type N 155
- Type R 154
- Type S 155
- Type T 156
- Type U 156
- Thermocouple Measurement..... 154
- Thermocouple Simulation..... 154
- Voltage Generation..... 147, 148
- Voltage Measurement 145, 147
- Spinning..... 55
- Stability Test 71
- Stand 9
- Starting MC2..... 17, 36
- Status Bar 18
- Stepping 73
- Support..... 9
- Switch Calibration 132
- Switch State Sensing 49
- Symbols
 - 2-Wire RTD Connection 117
 - 3-Wire RTD Connection 116
 - 4-Wire RTD Connection 116
 - Alarms..... 69
 - Barometric Pressure..... 92
 - Compensation Loop, RTD 117
 - Cumulative Average 91
 - Deviation Reference 91
 - Difference 91
 - Maximum Value..... 90
 - Maximum-Minimum 91
 - Minimum Value..... 90
 - Normal Reading..... 91
 - Pulses Done 93
 - Pulses Left..... 93
 - Rate of Change 90
 - Redundant Measurement..... 91
 - Redundant Reference 91
 - RJ Temperature..... 92
 - Sensor Resistance 92
 - Thermovoltage..... 92

T

- Tare 87
- Tasks, Simultaneous..... 119
- Teaching capacity indication 14
- Temperature Indicator
 - Calibration..... 130
 - recorder
 - calibration 130
 - Scale 99
 - Sensor
 - Calibration..... 134
 - Unit..... 99
- Terminals..... 8
- Test Diode, Measurement
 - Parallel to a..... 118

- Test Point Sets, Custom..... 101
- Testing Leakage/Stability 71
- Text Fields 22
- Thermocouple Simulation..... 64
- Thermocouple Types
 - Optional 157
- Thermovoltage Measurement..... 92
- Tools 67
 - Alarms 69
 - Damping 70
 - Deviation Measurement 87
 - Difference Measurement 89
 - Error % 82
 - Error in Input Units 83
 - Error in Output Units..... 84
 - Function Info..... 68
 - Leak/Stability Test..... 71
 - Manual Stepping..... 78
 - Percentage Display 85
 - Ramping 76
 - Redundant Measurement..... 88
 - Scaling 86
 - Stepping 73
 - Tare 87
- Transfer Functions, Custom 103
- Troubleshooting
 - thermocouple measurement..... 115
 - Typographical Conventions 3

U

- Unpacking and Inspection 4
- Updating the Firmware 17, 33
- USB Connector 8
- USB Driver 15
- User Configurable Pressure
- Units..... 106
- User Interface..... 18
- User Setups 97

V

- Viewing Angle of the Display 9
- Voltage Generation 66
- Voltage Measurement 53
- Volume Settings 99

W

- Warnings..... 28

Z

- Zeroing a Pressure Module 46

