

CAL 3200 AUTOTUNE TEMPERATURE CONTROLLER OPERATING MANUAL



CAL Controls

1 IMPORTANT SAFETY INFORMATION ... PLEASE REVIEW

1.1 INSTALLATION



Designed for use:
UL873 – only in products where the acceptability is determined by Underwriters Laboratories Inc.
EN61010-1 – within Installation Categories II and III environment and pollution degree 2.

To avoid possible hazards accessible conductive parts of final installation should be protectively earthed in accordance with EN61010 for Class 1 equipment. Output wiring should be within a grounded cabinet. Sensor sheaths should be bonded to ground or not be accessible.

Live parts should not be accessible without use of a tool. It is the responsibility of the installation engineer to ensure that this equipment's compliance to EN61010 is not impaired when fitted to the final installation and to use this equipment as specified in this manual, failure to do so may impair the protection provided. Ensure the installation is in compliance with appropriate wiring regulations

1.2 CONFIGURATION

All functions are front key selectable, it is the responsibility of the installing engineer to ensure that the configuration is safe. Use the program lock to protect critical functions from tampering

1.3 ULTIMATE SAFETY ALARMS

Normal safety advice: Do not use SP2 as the sole alarm where personal injury or damage may be caused by equipment failure

WARRANTY

CAL Controls warrant this product free of defects in workmanship and materials for three (3) years from date of purchase

- Should the unit malfunction, return it to the factory. If defective it will be repaired or replaced at no charge
- There are no user-serviceable parts in this unit. This warranty is void if the unit shows evidence of being tampered with or subjected to excessive heat, moisture, corrosion or other misuse
- Components which wear, or damage with misuse, are excluded e.g. Relays
- CAL Controls shall not be responsible for any damage or losses however caused, which may be experienced as a result of the installation or use of this product. CAL Controls liability for any breach of this agreement shall not exceed the purchase price paid E. & O.E.

IN BRIEF ...

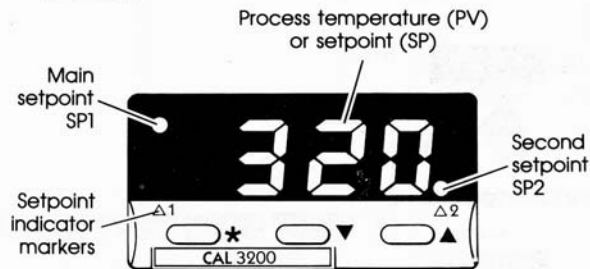

Routine adjustments

- * View setpoint
- * ▲ Increase setpoint
- * ▼ Decrease setpoint

To reset alarm or fault message

- ▼ ▲ Momentarily press together

SYMBOLS USED IN THE MANUAL

* ▼ ▲ Keys



Press and hold

Press and release



Alternating display



Indicator: flashing

bAnd

tunE

10

Function/
Option
display

Thank you for choosing the CAL 3200
a new concept in advanced, full feature,
compact temperature control



Please

Familiarise yourself:

Scan the contents list and look through the manual, note sections of interest



Before installation:

Review the important safety information in section 1



Installation and connection:

Instructions see sections 4/5



Setting-up instructions

Choose the format you prefer:



Fully explained step-by-step

Start section 6

or ...



Abbreviated instructions

Minimum explanation for those familiar with micro-processor based controllers ... section 3 under front flap

INTRODUCTION

Section	Page
1 IMPORTANT SAFETY INFORMATION	P1
2 CONTROL FUNCTIONS MENU	P3
3 ABBREVIATED SETTING-UP GUIDE	P4
4 MECHANICAL INSTALLATION	P5
5 ELECTRICAL INSTALLATION	P6
6 INITIAL CONFIGURATION / SETTING-UP / FACTORY SETTINGS	P7
7 AUTOTUNE	P9
8 VIEWING AND SELECTING FUNCTIONS	P11
9 PROPORTIONAL CYCLE-TIME	P13
10 SECOND SETPOINT – SP2 ALARMS AND COOL STRATEGY	P15
11 RANGING AND SETPOINT LOCK	P17
12 IMPROVING CONTROL ACCURACY	P17
13 OEM PROGRAM SECURITY	P18
14 OEM SECURE LEVEL 4	P19
15 ERROR MESSAGES AND DIAGNOSIS	P19
16 FUNCTIONS AND OPTIONS: LEVEL 1	P20
17 3200 SPECIFICATION	P24
18 CUSTOMER CONFIGURATION RECORD	REAR

To reset alarms and error messages:

Press ▼▲ together briefly

2 FUNCTIONS MENU AND PROGRAM MODE GUIDE

Brief Guide:

- 1. Enter/exit**
program mode
Press and hold
▼▲ 3 sec



2. Single level navigation

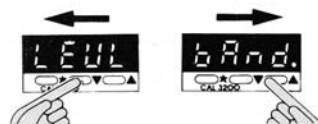

3. View/Change Option

- View
Function/
Option



- Autotune
Option value



- To change
Option value
(or * ▼)
Release: check correct

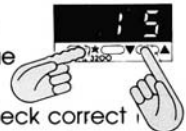

4. Changing menu levels

- Locate level
Function



- Select new
level

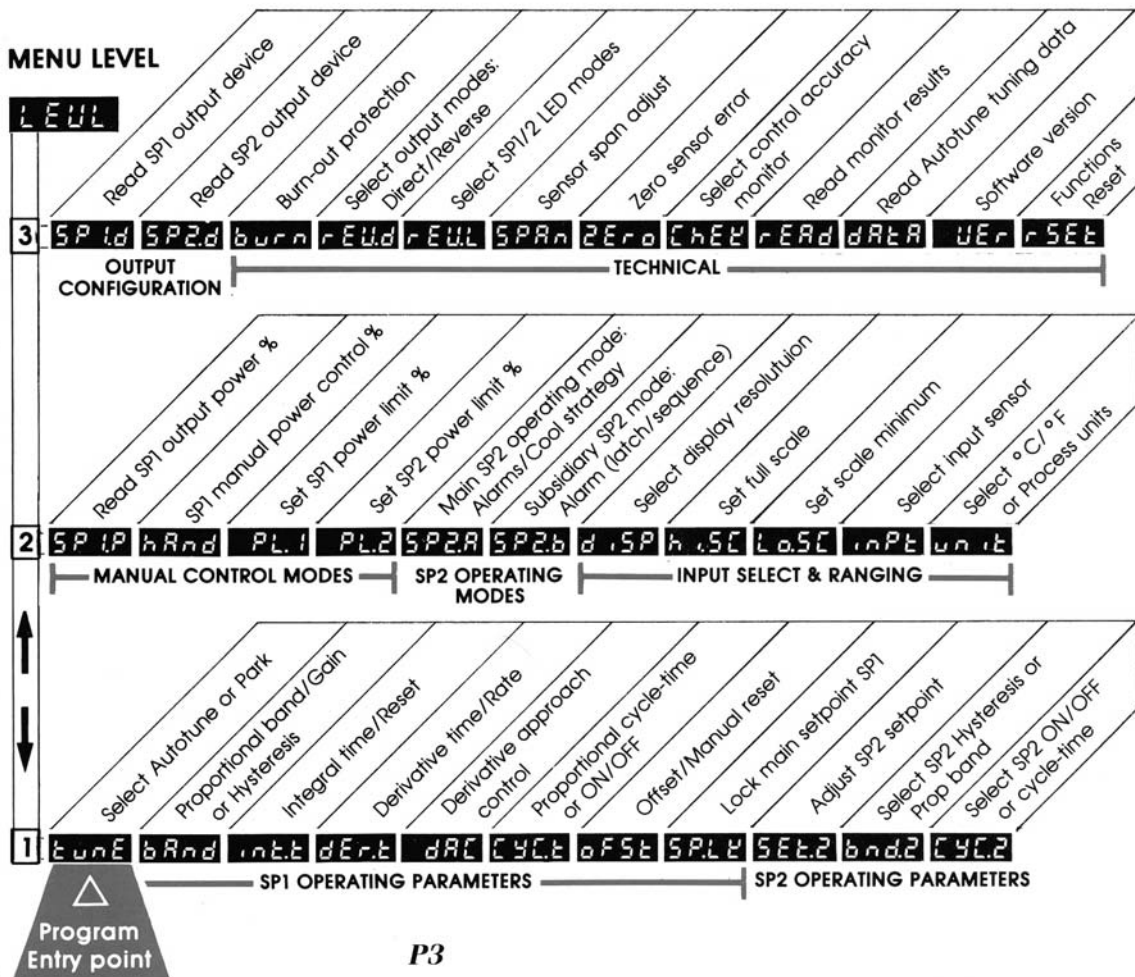

3 ABBREVIATED SETTING-UP INSTRUCTIONS

... FOR FULL INSTRUCTIONS SEE SECTION 6 ...

1. Power-up

Alternating display after self-test



2. Select input sensor

To select:
Press and hold *
Press ▲



Check correctly selected



3. Select °C/°F

Press once



To select



4. Select main setpoint output device see 5.3

Press once



Select:
SSR drive



or

2A relay



Important:

Check correct device selected



If any difficulty in initial configuration:

Press and hold ▼▲ 3 sec
To display the next step, release keys together



5. Enter initial configuration

Hold both 3 sec



Normal operating mode:
No setpoint entered yet



6. Select other functions

Now or later:
see guide and menu to left

7. Setpoint display/adjust

Display setpoint



To increase setpoint



To decrease setpoint



8. To Autotune

Enter program mode
hold both 3 sec

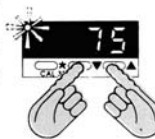

Entry point



Select

tune/on

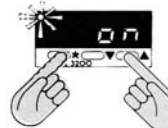

Exit program mode
Hold both 3 sec

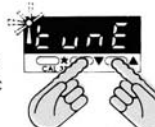

Display during Autotune



Note: Setpoint locked during Autotune.
to adjust

tune/oFF

9. For optimum cycle-time see 9.4

Operational with factory PID settings

4 MECHANICAL INSTALLATION

1. Prepare a 1/32 DIN panel cutout:
45.0mm +0.6/-0 x 22.2mm +0.3/-0
1.77" +0.02/-0 x 0.87" +0.01/-0
2. Unplug connector now if wiring separately
3. Slide the controller into the cutout
4. Slide the panel clamp on the controller and press it firmly against the panel
Note: To remove the panel clamp the two side levers should be pressed in
5. Refit the connector if removed. To further secure the connector slide the green lock as shown
6. After installation remove protective front window label
7. Cleaning – wipe down front with damp cloth (water only)

4.1 3200 CONTROLLER PROTECTION RATING

The 3200 controller front of panel assembly is rated NEMA 4X/IP66 provided:

- The panel is smooth, and cutout accurate
- The panel clamp is pressed firmly against the panel, ensuring that the clamp springs are fully compressed

4.2 MULTIPLE 3200 INSTALLATIONS

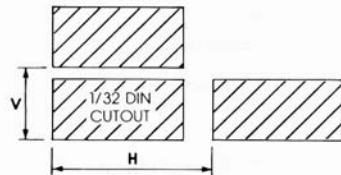

Guide for spacing:

	V	H
Minimum	30 (1.18)	60 (2.36)
Allows clamp removal	30 (1.18)	70 (2.76)
Allows clamp and connector removal ... Recommended	35 (1.38)	70 (2.76)

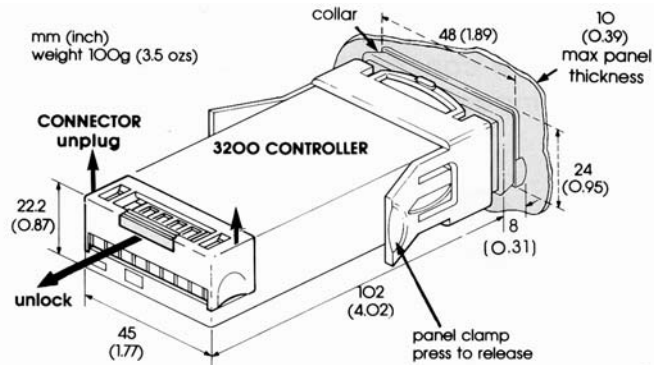

OPTIONAL 1/16 DIN PANEL ADAPTORS: 48 (1.89) square
Enable 3200(s) to be mounted in a 1/16 DIN cutout

4.3 1/16 DIN 3200 adaptor: Accepts one 3200

1. Remove collar/gasket from 3200, grip firmly and pull off
2. Assemble adaptor halves either side of panel, locate pegs
3. Slide 3200 into adaptor, fit panel clamp and press firmly against adaptor

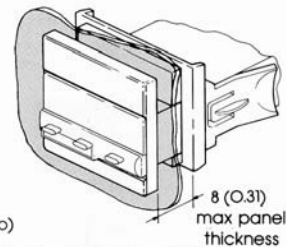

4.4 1/16 DIN 3200 Twin adaptor: Accepts two 3200s

1. Remove collars from both 3200s
2. Fit special collars included with twin panel clamp
3. Slide both 3200s into cutout, fit twin panel clamp and press firmly against panel

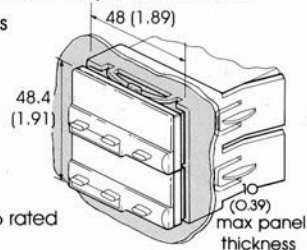

PANEL CUTOUT 45 x 46.2 +0.6/-0
(1.77 x 1.82 +0.02/-0)

Panel adaptors are not NEMA 4X/IP66 rated

5 ELECTRICAL INSTALLATION

CAUTION RISK OF ELECTRIC SHOCK

5.1 Supply Voltage: 100-240V 50-60 Hz \pm 10% 3VA
12V or 24V (AC/DC) \pm 20% 3VA
Polarity not required
3200 is fitted with internal 250mA time lag fuse

5.2 Output devices (two)

Solid state relay drive **SSd**
5Vdc \pm 0/-15%, 10mA non-isolated
To switch a remote SSR (or logic)

Miniature power relay **rLY**
2A/250V~resistive, Form A/SPST contacts

5.3 Output device allocation

Either the SSd or the relay may be chosen as the output device for the main setpoint SP1, the remaining device being automatically allocated to the second setpoint SP2. Choose the most suitable output device arrangement for the application and wire accordingly

5.4 Wiring the 8 way connector

Maximum recommended wire: 32/0.2mm 1.0mm² (18AWG 0.04"²). Prepare cables carefully.
Important: remove a maximum of 6mm (0.25") insulation to avoid bridging. Prevent excessive cable strain on the connector

5.5 Switching inductive loads with the relay

To prolong contact life and suppress interference it is good engineering practice to fit a snubber (0.1 μ f/100) **see Example B**
Caution: Snubber leakage current can cause some electro-mechanical devices to be held ON. Check manufacturers specification

Example A

The SSd output is allocated to SP1 and wired to switch the load (heater) using an SSR

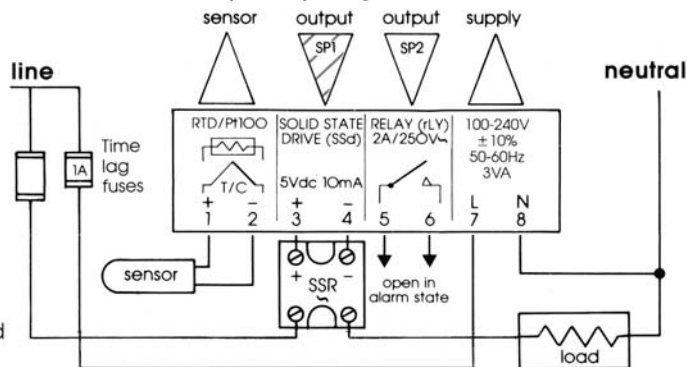

Example B

The relay output is allocated to SP1 and wired to switch the load (heater) using a contactor

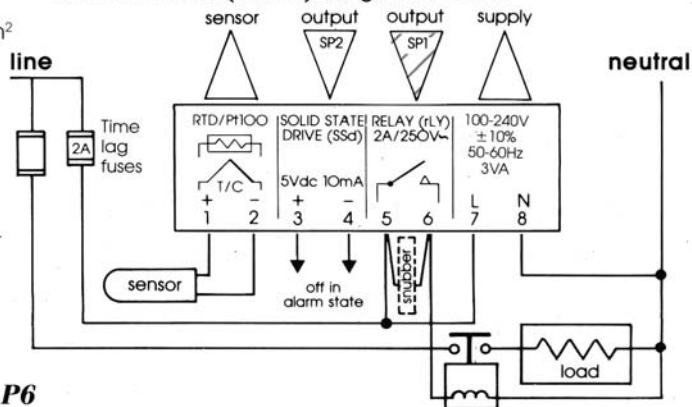

6 INITIAL SETTING UP

6.1 OVERVIEW

Three steps from initial power-up to accurately tuned control

6.1.1 Details required for initial configuration

1. The temperature sensor being used: thermocouple or RTD/Pt100
2. °C or °F
3. Choice of controller output device for the main setpoint SP1, either:
The solid state relay drive **SSd**
or the miniature power relay **rLY**
4. Any additional controller functions, e.g. SP2 Alarms, may be selected now or later

6.1.2 Set the temperature required

The controller is now operational with factory PID settings

6.1.3 To tune the 3200 precisely to the application:

- Run the Autotune program **see 7**
This automatically adjusts the PID control parameters to the characteristics of the application
- Or enter PID values manually
Where the optimum values are already known

NOTE:

If any difficulty in initial configuration:
Press and hold $\blacktriangledown\blacktriangle$ 3 sec
To display the next step
Release keys together

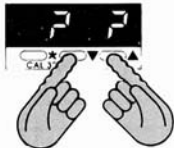

6.2 INITIAL CONFIGURATION

6.2.1 Power up

Self test sequence (and brief display blanking)

The alternating display shows that no input sensor is selected and that one is required

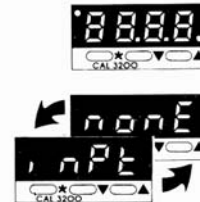

6.2.2 To enter the input sensor type

Press and hold *

Press \blacktriangle to select the sensor e.g. K

Press \blacktriangledown to reverse indexing

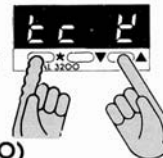

Input sensor options (also see 16.2.10)

Thermocouples

sensor type	mnemonic
B	t c b
E	t c E
J	t c J
K	t c K
L	t c L

sensor type	mnemonic
N	t c n
R	t c r
S	t c S
T	t c t

Resistance thermometer

RTD-2	
Pt100	r t d

Linear process inputs, see 16.2.10

After selection release *

Check that the selection is correct



6.2.3 To select display in °C or °F

Press ▲ once



The display shows that no display unit is selected



To select °C or °F
(Bar, PSI, Ph, Rh)

Press and hold *

Press ▲ to select °C, °F etc

Release *

Check display alternating with **unit** is correct



6.2.4 To allocate SP1 - main setpoint output device

Press ▲ once



The display shows that no output device has been allocated to SP1



Available SP1 output devices:

Solid state relay drive



Miniature power relay



The remaining output device is automatically allocated to SP2

To select SP1 output device

Press and hold *

Press ▲ to select



Important:

Check correct device selected, as fixed once entered in memory, changeable only on full reset, see 16.3.12



6.2.5 To enter the initial configuration into the Controllers memory

Press and hold both ▼ and ▲ for 3 seconds (Display may differ)



Process temperature displayed e.g. Ambient 23 °C and alternate as no setpoint yet selected



6.2.6 To display setpoint

Press and hold *

°C/O or °F/32 alternate

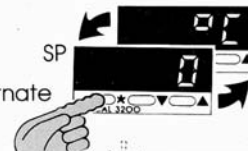

6.2.7 To adjust setpoint

Press and hold *

Press ▲ to increase/

▼ to decrease

Flashing LED shows SP1 output ON.

The temperature rises



Controller operational with factory PID settings:

Proportional band/Gain 10 °C/18 °F
 Proportional cycle-time 20 secs
 Integral time/Reset 5 mins
 Derivative time/Rate 25 secs
 DAC Derivative approach control 1.5

7.1 TO USE AUTOTUNE – TUNE PROGRAM

7.1.1 For best results:

- Start with the load cool
- Set the usual setpoint temperature and use normal load conditions

7.1.2 To enter program mode

Press and hold both ▼▲ for 3 seconds

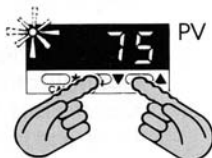

Release together when **tunE** is displayed on entry to program mode
If display differs, **see 2** for functions menu, press ▼ or ▲ to locate **tunE**



7.1.3 To select **tunE/OFF**

Press and hold *
Press ▲ once



Release *



7.1.4 To start TUNE program

Press and hold both ▼▲ for 3 seconds

To exit program mode starting **tunE** (Display may differ)

Release ▼▲

Display during **tunE** program

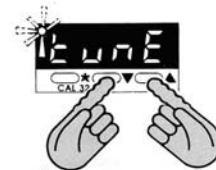

NOTE: Setpoint is locked during **tunE** to adjust

select **tunE/OFF**



TUNE program complete

Alternating display stops

New PID values are entered automatically



Process temperature climbs to setpoint



The Autotune – TUNE program

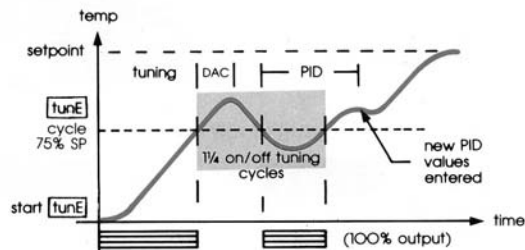

7.2 MORE ON AUTOTUNE

7.2.1 Operation

Autotune 'teaches' the controller the main characteristics of the process. For best results run Autotune with the usual setpoint temperature under normal load conditions

Autotune 'learns' by cycling the output on and off. The results are measured and used to calculate optimum PID values which are automatically entered in the controller memory

PID Parameters tuned

1. Proportional band/Gain
2. Proportional cycle-time (requires manual acceptance unless pre-selected, **see 9**)
3. Integral time/Reset
4. Derivative time/Rate
5. Derivative approach control (DAC)

Two alternative forms of Autotune are provided, **TUNE** and **TUNE AT SETPOINT**, the use of each is described below

7.2.2 The Autotune - TUNE program



To run **TUNE** select **tunE/on**, **see 7.1**
Start with the load cool. The output is cycled at 75% of the setpoint value to avoid any overshoot during the tuning cycle. The warm-up characteristics are monitored to set DAC which minimises overshoot on subsequent warm-ups

7.2.3 The Autotune - TUNE AT SETPOINT program



To run **TUNE AT SETPOINT** select **tunE/At.SP** **see 7.1.3**: Press ***** and hold, press **▲** 3 times
The tuning cycle occurs **at setpoint** and in some applications, may give better results, see examples below:

The TUNE AT SETPOINT program is recommended:

1. When the setpoint is below 100°C/200°F, where **TUNE's** tuning cycle at 75% setpoint may be too close to ambient to produce good results
2. When the process is already hot and the cooling rate is slow
3. When controlling multi-zone or heat-cool applications
4. To re-tune if the setpoint is changed substantially from the previous Autotune

Note: DAC is not re-tuned by Tune at Setpoint

The Autotune - TUNE AT SETPOINT program

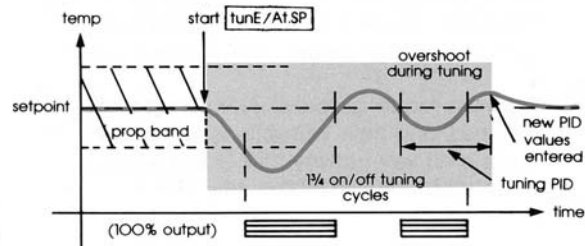

8.1 FUNCTIONS AND OPTIONS

The facilities of the 3200 are selected from the multi-level menu using program mode

For menu of main Functions .. see 2

For Functions and Options list .. see 16

8.1.1 Definitions

Functions (Fn): The controllers facilities

Options (Opt): The available values for a function

Example:

Function: Proportional band

Option: 15 °C / °F selected



Short reference: **bAnd/15** (Fn/Opt)

8.1.2 Control during programming

Control with existing settings is maintained during programming. Control with new instructions commences only on exiting program mode, when the controller memory is updated

8.1.3 Hints when using program mode

Some options will not adjust! Maybe the lock has been applied. All functions and current options may be viewed even when locked

Program mode auto-exit: Normal operation is restored, and new instructions entered, if there is no key activity for 60 sec when in program mode (to disable, see 14.4.4)

8.1.4 The multi-level Function and Option menu For menu of main Functions .. see 2

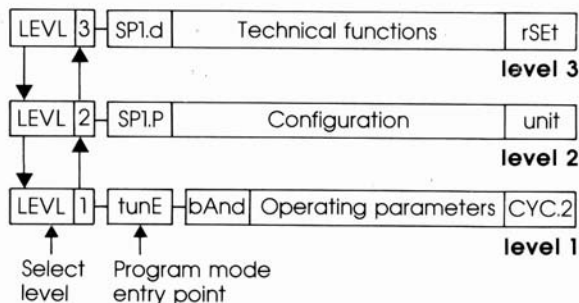

8.2 USING PROGRAM MODE

8.2.1 To enter program mode from normal operating mode

Press and hold both ▼▲ for 3 seconds

Enter program mode at **tunE**
Function on level 1,
see diagram above

Release both ▼▲ together

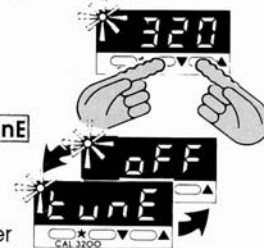

8.2.2 To exit program mode at any time returning to normal operating mode

Press and hold both ▼▲ for 3 seconds

NOTE: Control commences with any new instructions now entered in memory



8.2.3 To view Functions on the same level

Press ▼ or ▲ once to view the next Function

or hold ▼ or ▲ to auto-index through the Functions

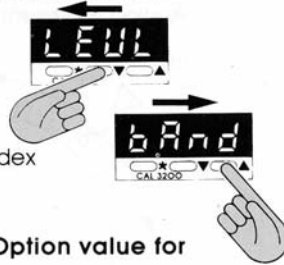

8.2.4 To display the current Option value for a Function

On release of ▼ or ▲ Option alternates with the Function:
Function **bAnd**
Option **10** °

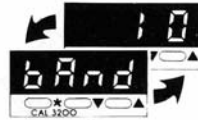

8.2.5 Autotune Option values

Autotune calculated value indicator

If a manual Option is selected, the Autotune value is retained in memory



8.2.6 To change an Option value or setting

Index to the required Function e.g. **bAnd**
Press and hold *
Current Option displayed: **10** °

Press ▲ to increase/ ▼ to decrease
e.g. **bAnd** increased to **15** °
Release *

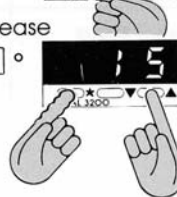

IMPORTANT:
Check the new Option value **before** moving to another Function or exiting program mode

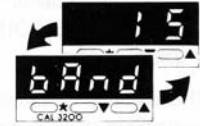

8.2.7 To change menu levels

Press and hold ▼ to reach the level selection function

Release ▼ to display the current level **1**



Press and hold *
Press ▲ to increase level (2)
or Press ▼ to decrease level

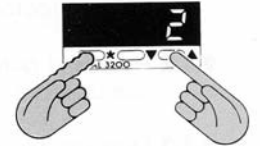

Release * to display the new level **2**



Reminder:

Use ▼ and ▲ to locate Functions on each level
To exit program mode and return to normal operation: Press and hold both ▼▲ 3 seconds or auto-exit program mode after 60 seconds inactivity

9 PROPORTIONAL CYCLE-TIME

Optimum cycle-time is calculated by Autotune **TUNE** or **TUNE AT SETPOINT** programs, but **not** automatically implemented

The choice of cycle-time is influenced by the external switching device or load, e.g. contactor, SSR, valve

Note: A setting that is too long for the process will cause oscillation
Too short a setting will cause unnecessary wear to an electro-mechanical switching device

9.1 ALTERNATIVE CYCLE-TIME SELECTION METHODS

see instructions opposite

9.1.1 Run Autotune. On completion check the calculated cycle-time, **see 9.4**

- Accept
- Or select nearest suitable value (20 sec factory setting applies unless replaced)

9.1.2 Pre-select automatic acceptance of **any** calculated Autotune cycle-time, **see 9.5**

9.1.3 Manually pre-select any cycle-time between 0.1 and 81 sec, this will not be changed, **see 9.6**

9.1.4 To use the 20 sec factory set cycle-time no action is needed whether Autotune is used or not

Note: When an Autotuned cycle-time **A XX** has been accepted it is automatically updated on each subsequent Autotune

IF IN DOUBT USE METHOD 1 ABOVE

9.2 **CYC.f** CYCLE-TIME SETTINGS

Analog representation

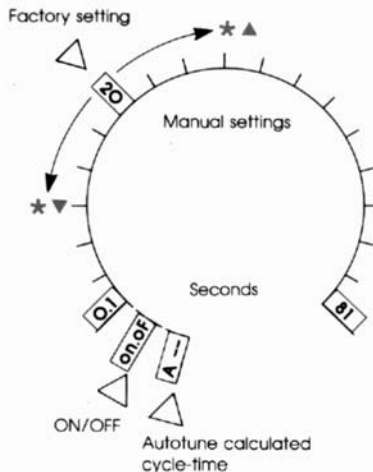

9.3 CYCLE-TIME RECOMMENDATIONS

To avoid premature relay failure

Output device	Cycle-time	Load (resistive)
Internal relay rLY	20 sec or more	2A/250V~
	Recommended	
	10 sec minimum	
	5 sec minimum	1A/250V~
Solid state drive SSd	1 – 3 sec typical	SSR
	(Range 0.1–81 sec)	
	0.1 sec	Logic/PIM

9.4 TO SELECT AUTOTUNE CALCULATED CYCLE-TIME

On completion of Autotune

9.4.1 Enter program mode

Press and hold both ▼▲ for 3 seconds



9.4.2 Index to cycle-time Function

Press and hold ▲



Release ▲

20 second factory setting displayed



9.4.3 To view calculated optimum cycle-time

Press and hold * then Press and hold ▼ until indexing stops: e.g. calculated cycle-time is 16 sec
If suitable accept



9.4.4 Manual selection of more suitable cycle-time

If the calculated value is not compatible with the switching device e.g. 30 sec more suits a contactor
Press and hold * Press ▲



9.4.5 Enter the cycle-time in memory

Press and hold both ▼▲ for 3 sec
To exit program mode and implement the new instructions



9.5 TO PRE-SELECT AUTOMATIC ACCEPTANCE OF ANY AUTOTUNE CYCLE-TIME

9.5.1 Before Autotune is selected

Enter program mode, index to cycle-time
Function **[CYC.t]** see 9.4

9.5.2 Select Autotune calculated cycle-time

Press and hold * then Press and hold ▼ until indexing stops

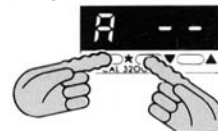

A -- Shows no Autotune cycle-time yet exists

9.5.3 Autotune **[tunE/on .. /At.SP]** must be selected now, BEFORE exiting program mode

Press and hold ▼ to **[tunE]** Function



9.6 TO PRE-SELECT CYCLE-TIME BEFORE AUTOTUNE

9.6.1 Before Autotune is selected

Enter program mode Index to cycle-time
Function **[CYC.t]** see 9.4

9.6.2 Select preferred value

Press and hold * then Press ▲ to increase (35 sec) or ▼ to decrease



9.6.3 Either exit program mode

see 9.4.5 (left), or index to another function

10 USING THE SECOND SETPOINT - SP2

10.1 TO CONFIGURE SP2 AS AN ALARM

1. Select the main SP2 operating mode in **SP2.A**, see 10.4
2. If required, select a subsidiary SP2 mode in **SP2.b**, see 10.5
3. If the factory set 2.0°C/3.6°F hysteresis is unsuitable, change in **bnd.2**
Set **CYC.2** ON/OFF (factory setting)
4. Adjust SP2 setpoint in **Set.2** (to set y° in 10.4)
5. Exit program mode - SP2 is now operational as an alarm

10.2 TO CONFIGURE SP2 AS A PROPORTIONAL CONTROL OUTPUT

1. Select the main operating mode in **SP2.A**, see 10.4
2. Select SP2 proportional band in **bnd.2** and SP2 cycle-time in **CYC.2**
3. Adjust SP2 setpoint in **Set.2** (to set y° in 10.4)
4. Exit program mode - SP2 is now operational as a control output with time proportioning control action

10.3 SP2 IN COOL STRATEGY

For full instructions see separate data:
'3200 control of heat-cool applications'

Cool strategy Options:

- Cool** in **SP2.A** (Selects cool strategy)
nLin in **SP2.b** (Non-linear proportional band)

10.4 **SP2.A** MAIN SP2 OPERATING MODE: ALARMS OR COOL STRATEGY

factory setting **none**

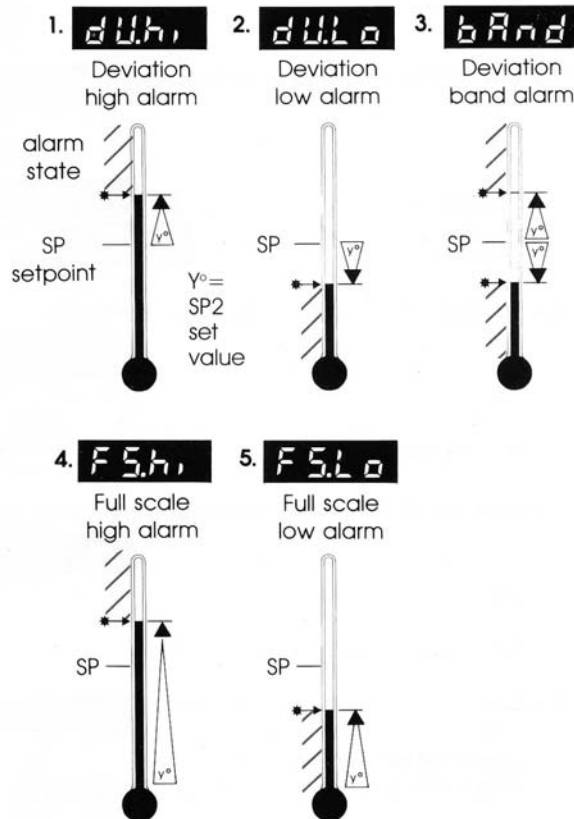

10.5 **SP2.6** SUBSIDIARY SP2 MODE: LATCH/
SEQUENCE OR NON-LINEAR COOL

factory setting **none**

10.5.1 **Ltch** Latch alarm

When selected the alarm output and indicator latch,
When the alarm condition has been cleared,
momentarily press **▼▲** together to reset

10.5.2 **hold** Sequence alarm

When selected, in any alarm mode, prevents an alarm
on power up. The alarm is enabled only when the
process temperature reaches setpoint
Example: Sequence alarm used with deviation low
alarm – **dV.Lo**

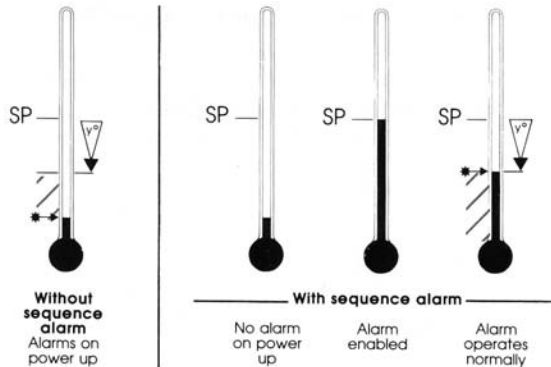

10.5.3 **Ltcho** Latch and sequence alarm

10.6 SP2 OUTPUT AND LED INDICATOR STATES –
IN ALARM CONDITION

ALARM TYPE	ON-OFF OPERATING MODE		PROPORTIONAL OPERATING MODE	
	SP2 Output state	SP2 LED state	SP2 Output state	SP2 LED state
Deviation dV.hi dV.Lo bAnd			 bAnd : on-off mode only	
Full scale FS.hi FS.Lo				
Cool Strategy	Temperature above setpoint			

- Output ON (Relay or SSd energised)
- Output OFF (Relay or SSd de-energised)
- LED ON

10.7 **-AL-** SP2 ALARM ANNUNCIATOR

When an SP2 alarm mode is selected in **SP2.A** the
alarm annunciator **-AL-** is displayed, alternating
with process temperature, during an alarm condition
(or until reset if the latch alarm is selected)

The annunciator may be disabled see 14
Function **no.AL** , select Option **on**

11.1 RANGING: IMPORTANT SAFETY NOTE

The factory setting of full-scale **hi.SC** is the sensor maximum value, see 16.2.10 this should be reduced to a safe maximum for the plant or process

11.1.1 **hi.SC** full-scale and **Lo.SC** scale minimum

- hi.SC** limits the maximum setpoint adjustment, **Lo.SC** limits the minimum. Both adjust over the full sensor range, including negative
- Factory settings:
 $\text{hi.SC} = \text{sensor maximum}$, $\text{Lo.SC} = 0^\circ\text{C}/32^\circ\text{F}$
 Reduce **Lo.SC** to set below $0^\circ\text{C}/32^\circ\text{F}$
- hi.SC** may not be adjusted below the **Lo.SC** setting, **Lo.SC** not above **hi.SC**

11.1.2 Example: Setpoint limited to 400° - 600°C

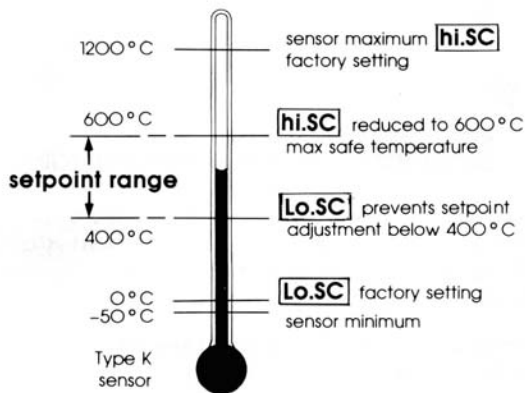

11.2 **SP.LK** SETPOINT LOCK

This function in level 1 enables the machine setter to lock the setpoint preventing unauthorised adjustment

12 **TOOLS TO IMPROVE CONTROL ACCURACY**

To assist engineers with machine development, commissioning and trouble shooting

12.1 **SPI.P** READ SPI OUTPUT PERCENTAGE POWER

Poor control may be due to incorrectly sized heaters. **SPI.P** constantly displays the output percentage power applied, which at normal setpoint should be within 10-80% (preferably 20-70%) to achieve accurate control

12.2 **ChEK** CONTROL ACCURACY MONITOR

12.2.1 This enables the accuracy of the temperature control, to within 0.1°C/°F, to be established. The monitor is started using **ChEK** and the variance (deviation), maximum and minimum temperatures are displayed and constantly updated in **REAd**

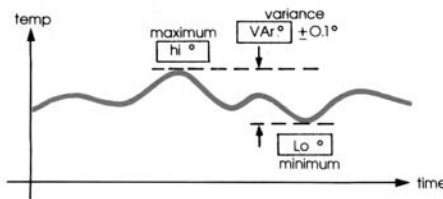

12.2.2 Control accuracy monitor: Read outs

12.2.3 Using the **ChEK** Control accuracy monitor

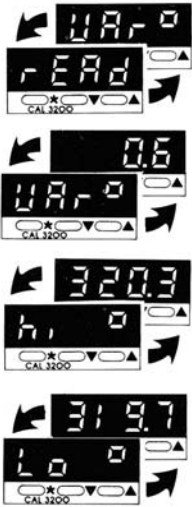
- To start the monitor select **ChEK on**
- During monitoring either return to normal operation or remain in program mode
- To view monitor readings: Index to **rEAd**
Release ▼ or ▲

- Press and hold *
Displays **variance** (0.6°)
- Hold * pressed
Press ▲ once
Displays **maximum** (320.3°)
- Hold * pressed
Press ▲ once more
Displays **minimum** (319.7°)
- ChEK off** stops monitor, retaining readings
Next **ChEK on** resets readings
- On de-powering: **ChEK** resets to **off** and **rEAd** zeroed

IMPORTANT NOTE FOR OEM'S: For safety and to protect settings from tampering USE THE SOFTWARE SECURITY LOCK THEN REMOVE THIS SECTION

13.1 ENTRY TO HIDDEN LEVEL 4

Access to level 4 only at **Ver** in level 3

Press and hold ▼▲ 10 sec
Hint: Press ▲ to index along level, then ▼ also immediately **Ver** is reached



Enter level 4 at **LoCK**
Release ▼▲ together
Factory setting: **nonE**



13.2 PROGRAM SECURITY USING **LoCK**

Select from 3 **LoCK** options:

Press and hold * Press ▲ to index

Locks levels 3 and 4 only
– TECHNICAL FUNCTIONS



Locks levels 2, 3 and 4 only
– CONFIGURATION AND
TECHNICAL FUNCTIONS



Locks all functions *



13.3 NOTES:

- Locked functions and current options may be read
- * Unrestricted: **LEVEL** **Ver** **dAtA** **SP.LK**

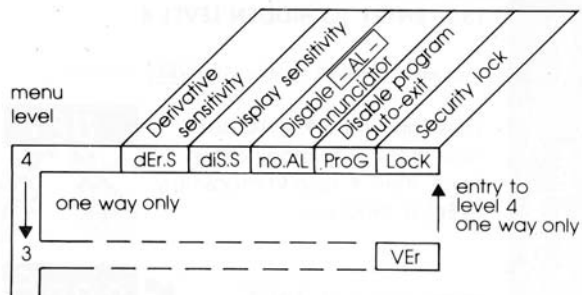

14.(4.1) **dEr.S** - x **dEr.t**
Derivative sensitivity

14.(4.2) **di.SS** -
Display sensitivity
 = Direct display of input
 = Maximum = Minimum sensitivity

14.(4.3) **no.AL**
Disable SP2 Alarm annunciator
 Select to disable

14.(4.4) **ProG**
Program mode auto-exit switch
 Auto-exit returns display to normal if 60 sec key inactivity. Select to disable

14.(4.5) **LoCK**
Program security lock, see 13.2

15.1 Sensor fault

Thermocouple burnout
 RTD/Pt100 short circuit
 Negative over-range

Action: Check sensor/wiring



15.2 Non-volatile memory error

Action: De-power briefly
 Replace unit if it persists



15.3 Manual power error

SP1 in ON/OFF in

Action: Select proportional mode



15.4 Immediate fail on Autotune start

1. Setpoint unset on new unit
2. SP1 at ON/OFF in

Select proportional mode

Note: Message latches
 Press briefly to reset



15.5 Fail during Autotune tuning cycle

The thermal characteristics of the load exceed the Autotune algorithm limits. The failure point is the first display in with

Action:

1. Change the conditions, e.g. raise setpoint
2. Try see 7.2.3
3. Check percentage power, see 12.1
4. **If the error message persists, call CAL for advice**

15.6 Reading Autotune tuning cycle results in **dAtA**

- Index to **dAtA**
Release ∇ or \blacktriangle
- Press and hold *****
Displays **Ct A** value (10.4)
i.e. Cycle time 'A' = 10.4 sec
- Keep ***** pressed
Press \blacktriangle once
Displays **Ct b** value (19.6)
i.e. Cycle time 'b' = 19.6 sec
- Repeat step 3 above to view:
Ct 1 Ct 2 Ct 3 Ct 4 , **oS 1 uS oS 2**

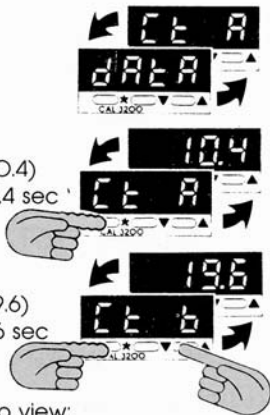

15.7 Autotune tuning data and limits

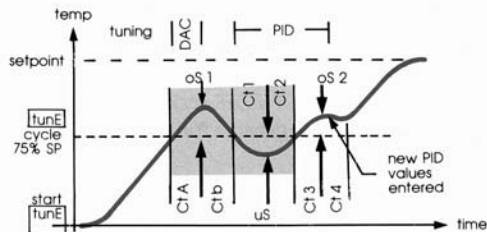

Autotune limits

Ct (Quarter cycle time): 1 – 1800 sec/30 min
oS (Overshoot) } max 255° C/490° F
uS (Undershoot) }

SELECT AUTOTUNE

16(1.1) **tunE** **oFF** **on** **PARk** **At.SP**

Select Autotune, see 7, or **PARk**

PARk temporarily turns the output(s) off. To use, select **PARk** and exit program mode. **oFF** disables Useful when commissioning fast loads or multizones

SPI OPERATING PARAMETERS

16(1.2) **bAnd** **0.1** – ***** °C/°F **10°C/18°F**

SPI Proportional band/Gain or Hysteresis
 * 25% sensor maximum

Proportional control eliminates the cycling of on-off control. Heater power is reduced, by time proportioning action, across the proportional band



Too narrow
 (oscillates)
 Increase **bAnd**



Too wide
 (slow warm up and response)
 Decrease **bAnd**

16(1.3) **intE** **oFF** **0.1** – **60** minutes **5.0**

SPI Integral time/Reset

Auto-corrects proportional control offset error



P20 **Too short**
 (overshoots and oscillates)



Too long
 (slow warm up and response)

16 FUNCTIONS AND OPTIONS: LEVEL 1

16(1.4) **der.t** OFF 1 - 200 seconds 25

SP1 Derivative time/Rate

Suppresses overshoot and speeds response to disturbances



Too short
(slow warm up and response, under corrects)



Too long
(oscillates and over corrects)

16(1.5) **dac** 0.5 - 5.0 x **bAnd** 1.5

SP1 Derivative approach control ... DAC

Tunes warm up characteristics, independent of normal operating conditions, by controlling when derivative action starts during warm up (smaller **dac** value = nearer setpoint)



Too small
(overshoots)



Too large
(slow stepped warm up)

16(1.6) **cycle** A -- on.oF 0.1 - 81 secs 20

SP1 Proportional cycle-time, see 9

Determines the cycle rate of the output device for proportional control. Select **on.oF** for ON/OFF mode



Ideal



Too long
(oscillates)

16(1.7) **oFSt** 0 - * °C/°F

SP1 Offset/Manual reset

* ± 50% **bAnd**. Applicable in proportional and ON/OFF mode with integral disabled: **Int.t / oFF**

16(1.8) **SPLY** OFF on

Lock main setpoint, see 11.2

SP2 OPERATING PARAMETERS

16(1.9) **SEt2** 0 - * °C/°F

Adjust SP2 setpoint, see 10

* Deviation alarms **DV.hi** **DV.Lo** **bAnd** : 25% sensor maximum

* Full-scale alarms **FS.hi** **FS.Lo** : sensor range

16(1.10) **band2** 0.1 - * °C/°F 2.0°C/3.6°F

Select SP2 hysteresis or Proportional band/ Gain

* 25% sensor maximum

16(1.11) **cyC2** on.oF 0.1 - 81 seconds

Select SP2 ON/OFF or Proportional cycle-time

Select **on.oF** for ON/OFF mode or the cycle rate of SP2 output device for proportional mode

MANUAL CONTROL MODES

- 16(2.1) **SP1P** - **100** % 'Read only'
Read SP1 output percentage power, see 12
- 16(2.2) **hRNd** OFF **1** - **100** % (Not in ON/OFF)
SP1 manual percentage power control
For manual control should a sensor fail
Record typical **SP1.P** values beforehand
- 16(2.3) **PL1** **100** - % duty cycle
Set SP1 power limit percentage
Limits max SP1 heating power during
warm up and in proportional band
- 16(2.4) **PL2** **100** - % duty cycle
Set SP2 percent power limit (cooling)

SP2 OPERATING MODES, see 10

- 16(2.5) **SP2A** **Main SP2 operating mode**
 nonE dV.hi dV.Lo bAnd
 FS.hi FS.Lo Cool
- 16(2.6) **SP2b** nonE LtCh hoLd Lt.ho nLin
Subsidiary SP2 mode: latch/sequence
Non-linear cool proportional band

INPUT SELECTION AND RANGING

- 16(2.7) **dISP** **1** 0.1 °
Select display resolution: 0.1° display of
PV, SP, OFSt SET.2 hi.SC Lo.SC
- 16(2.8) **hi.SC** sensor sensor
 minimum maximum °C/°F
Set full scale, see 11.1
- 16(2.9) **Lo.SC** sensor sensor
 minimum maximum °C/32°F
Set scale minimum, see 11.1

16(2.10) **inPt** **Select input sensor** nonE

Option/
sensor type **sensor range** **linearity**

Thermocouples

			linearity		
			±°C		
tc b	B	0 to 1800 °C	32 to 3272 °F	Pt-30%Rh/Pt-6%Rh	2.0 *
tc E	E	0 to 600 °C	32 to 1112 °F	Chromel/Con	0.5
tc J	J	0 to 800 °C	32 to 1472 °F	Iron/Constantan	0.5
tc K	K	-50 to 1200 °C	-58 to 2192 °F	Chromel/Alumel	0.25*
tc L	L	0 to 800 °C	32 to 1472 °F	Fe/Konst	0.5
tc n	N	-50 to 1200 °C	-58 to 2192 °F	NiCroSil/NiSil	0.25*
tc r	R	0 to 1600 °C	32 to 2912 °F	Pt-13%Rh/Pt	2.0 *
tc s	S	0 to 1600 °C	32 to 2912 °F	Pt-10%Rh/Pt	2.0 *
tc t	T	-200 / 250 °C	-273 / 482 °F	Copper/Con	0.25*

Resistance thermometer

rtd	-200 / 400 °C	-273 / 752 °F	Pt100/RTD-2'	0.25*
-----	---------------	---------------	--------------	-------

Linear process inputs (Input mV range: -10 to 50mV)

displays	0-20mV	4-20mV	setpoint limits	
Lin1	0 - 100		0 - 400	±0.5%
Lin2		0 - 100	-25 - 400	
Lin3	0 - 1000		0 - 3000	
Lin4		0 - 1000	-250 - 3000	
Lin5	0 - 2000		0 - 3000	

Notes:

- Linearity: 5-95% sensor range
- *Linearity B:5°(70° - 500°C)/K/N: 1°>350°C
exceptions: R/S:5°<300°C T: 1°<-25°>150°C
RTD/Pt100: 0.5°<-100°C
- Optional PIM Process Interface Module provides additional input/output options

16(2.11) **unIt** nonE °C °F bAr PSi Ph rh

Select °C/°F or process units

Processor calculates in °C, when °F converts
functions marked °C/°F (Process units
calculate as °C)

OUTPUT CONFIGURATION

16(3.1) **SP1.d** nonE rLY SSd
Select SP1 output device, see 5.3/6.2.4
Note: 'Read only' after initial configuration.
 RSEt ALL full reset to factory settings
 required to change SP1.d subsequently

16(3.2) **SP2.d** nonE SSd rLY 'Read only'
Read SP2 output device, see 5.3/6.2.4
 Shows SP2 output device

TECHNICAL FUNCTIONS

16(3.3) **burn** **Sensor burn-out/break protection**

Caution: Setting affects fail safe state

	SP1	SP2
<input type="checkbox"/> uP.SC	Upscale	Upscale
<input type="checkbox"/> dn.SC	Downscale	Downscale
<input type="checkbox"/> 1u.2d	Upscale	Downscale
<input type="checkbox"/> 1d.2u	Downscale	Upscale

16(3.4) **rEULd** **Select output modes:**
Direct/Reverse

Caution: Setting affects fail safe state

	SP1	SP2
<input type="checkbox"/> 1r.2d	Reverse	Direct
<input type="checkbox"/> 1d.2d	Direct	Direct
<input type="checkbox"/> 1r.2r	Reverse	Reverse
<input type="checkbox"/> 1d.2r	Direct	Reverse

Select **Reverse** on SP1 for heating and
Direct for cooling applications

16(3.5) **rEUL** **Select SP1/2 LED indicator modes**

	SP1	SP2
<input type="checkbox"/> 1n.2n	Normal	Normal
<input type="checkbox"/> 1i.2n	Invert	Normal
<input type="checkbox"/> 1n.2i	Normal	Invert
<input type="checkbox"/> 1i.2i	Invert	Invert

16(3.6) **SPAN** O.O - ±25% sensor maximum

Sensor span adjust

For recalibrating to a remote standard
 e.g. External meter, data logger

16(3.7) **ZEro** O.O - ±25% sensor maximum

Zero sensor error, see SPAn

16(3.8) **ChEV** OFF on

Select control accuracy monitor, see 12.2

16(3.9) **rEAd** VAr° hi° Lo°

Read control accuracy monitor, see 12.2

16(3.10) **dAtA** Ct A Ct b Ct 1 Ct 2
 Ct 3 Ct 4 oS 1 uS oS 2

Read Autotune tuning cycle data, see 15

16(3.11) **VER** Software version number

16(3.12) **rSEt** nonE ALL

Resets all functions to factory settings

Caution: Note current configuration **BEFORE**
 using this function, **see 18**, initial configuration
 and OEM settings must be re-entered

INPUTS, see 16(2.10)

Thermocouple – 9 types

Standards: IPTS 68/DIN 43710
CJC rejection: 20:1 (0.05° / °C) typical
External resistance: 100Ω maximum

Resistance thermometer: RTD-2/Pt100 2 wire
Standards: DIN 43760 (100Ω 0 °C/138.5Ω 100 °C Pt)
Bulb current: 0.2mA maximum

Linear process inputs: mV range: -10 to 50mV
See "PIM Process Interface Module" for additional input/output options

Applicable to all inputs: SM = sensor maximum
Calibration accuracy: $\pm 0.25\% SM \pm 1^\circ C$
Sampling frequency: Input 10Hz, CJC 2 sec
Common mode rejection: Negligible effect up to 140dB, 240V, 50-60Hz
Series mode rejection: 60dB, 50-60Hz
Temperature coefficient: 150 ppm/ °C SM
Reference conditions: 22 °C $\pm 2^\circ C$, rated voltage, after 15 minutes settling time

OUTPUT DEVICES (Standard), see 5.3

- **SSd:** Solid state relay drive: To switch a remote SSR 5Vdc +0/-15% 10mA non-isolated
- **Miniature power relay:** Form A/SPST contacts (AgCdO) 2A/250V~ resistive load

COOL CHANNEL when cool strategy selected

See separate data:

3200 control of heat-cool applications

CONTROL CHARACTERISTICS See 16:

SP1 PID Parameters: 16(1.1) – 16(1.8)
SP2 Parameters: 16(1.9) – 16(1.11)
SP2 Operating modes: 16(2.5) – 16(2.6)
Manual control modes: 16(2.1) – 16(2.4)

GENERAL

Supply Voltage: 100-240V $\pm 10\%$ 50-60 Hz 3VA
12V or 24V = $\pm 20\%$ 3VA
Digital LED display: 4 digits, 10mm (0.4in), high brightness green, Display range: -199 to 9999
Range: Sensor limited: 2000°C/3500°F
0.1 hi-res mode -199.9 to 999.9°
Process temperature (PV), Setpoint (SP), SP1/2 indicators (flashing), Error messages.
Function/Option mnemonics
Keypad: 3 Elastomeric buttons

ENVIRONMENTAL Approvals

Safety: UL873, CSA 22.2/142-87, EN61010
Humidity: Max. 80%
Altitude: Up to 2000M
Installation: Categories II and III
Pollution: Degree II
Protection: NEMA 4X, IP66
EMC Emission: EN 50 081-1, VDE 0871/78-Class A & B
FCC Rules 15 subpart J Class A
EN50082-1 RF Field Test:
EMC Immunity: <200 MHz 1%FS >200 MHz 5% FS
Ambient: 0-50 °C (32-130°F)
Mouldings: Flame retardant polycarbonate
Weight: 100g (3.5ozs)

SER No.						
LEVEL	DATE ▶	/	/	/	/	/
1.	bAnd					
	int.t					
	dEr.t					
	dAC					
	CYC.t					
	SEt.2					
	bnd.2					
	CYC.2					
2.	SP1.P					
	SP2.A					
	SP2.b					
	hi.SC					
	Lo.SC					
	inPt					
	unit					
3.	SP1.d					

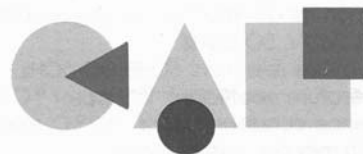

CAL Controls
Temperature Controllers



CAL Controls Ltd
Bury Mead Road, Hitchin, Herts, SG5 1RT, UK
Tel: +44 (0) 1462-436161 Fax: +44 (0) 1462-451801

CAL Controls Inc
1580 S. Milwaukee Avenue, Libertyville. IL 60048
Tel: (847) 680-7080 Fax: (847) 816-6852